

P.I.P. 01/21/2015

City of San Diego

CONTRACTOR'S NAME: NEW CENTURY CONST. INC. ELBE
 ADDRESS: 9119 EMERALD GROVE AVE. LAKESIDE, CA 92042
 TELEPHONE NO.: 619-390-3300 FAX NO.: 619-390-3311
 CITY CONTACT: Clementina Giordano, Contract Specialist, Email: Cgiordano@sanidiego.gov
Phone No. (619) 533-3481, Fax No. (619) 533-3633
S.Chavez/R.Taleghani/egz

CONTRACT DOCUMENTS



FOR

SOLOLA & EUCLID CR OBSTRUCTION DS

VOLUME 2 OF 2

BID NO.: L-15-1212-DBB-1
 SAP NO. (WBS/IO/CC): B-13069
 CLIENT DEPARTMENT: 2116
 COUNCIL DISTRICT: 4
 PROJECT TYPE: IJ

THIS CONTRACT IS SUBJECT TO THE FOLLOWING:

- THE CITY'S SUBCONTRACTING PARTICIPATION REQUIREMENTS FOR SLBE PROGRAM.
- COMPETITION RESTRICTED TO: SLBE-ELBE or ELBE FIRMS ONLY .
- PREVAILING WAGE RATES: STATE FEDERAL
- APPRENTICESHIP.

THIS BIDDING DOCUMENT TO BE SUBMITTED IN ITS ENTIRETY REFER TO VOLUME 1 COVER PAGE FOR TIME, DATE, AND LOCATION

ENGINEER OF WORK

The engineering Specifications and Special Provisions contained herein have been prepared by or under the direction of the following Registered Engineer:

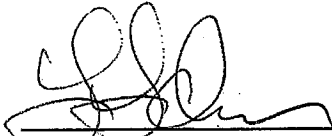

For City Engineer

11/4/14

Date

Seal



TABLE OF CONTENTS

DESCRIPTION	PAGE NUMBER
1. NOTICE INVITING BIDS.....	4
2. CONTRACT FORMS	14
1. Contract Agreement	15
3. CONTRACT FORMS ATTACHMENTS:	
1. Performance Bond and Labor and Materialmen’s Bond	18
2. Drug-Free Workplace.....	20
3. American with Disabilities Act (ADA) Compliance Certification	21
4. Contractor Standards - Pledge of Compliance Certificate	22
5. Affidavit of Disposal Certificate	23
6. Materials and Workmanship Compliance	24
7. Notice of Materials to Be Used	25
4. ATTACHMENTS:	
A. SCOPE OF WORK	27
B. INTENTIONALLY LEFT BLANK.....	29
C. EQUAL OPPORTUNITY CONTRACTING PROGRAM	30
D. INTENTIONALLY LEFT BLANK.....	34
E. SUPPLEMENTARY SPECIAL PROVISIONS	35
SUPPLEMENTARY SPECIAL PROVISIONS APPENDICES	52
1. Appendix A - Notice of Exemption	53
2. Appendix B - Fire Hydrant Meter Program	55
3. Appendix C - Materials Typically Accepted by Certificate of Compliance	69
4. Appendix D - Sample City Invoice	71
5. Appendix E - Location Map.....	73
F. INTENTIONALLY LEFT BLANK.....	75

CITY OF SAN DIEGO, CALIFORNIA

NOTICE INVITING BIDS

1. **LIMITED COMPETITION:** This contract may only be bid by the Contractors on the City's approved SLBE-ELBE Construction Contractors List in accordance with the designation stated on the cover page hereof. For information regarding the SLBE-ELBE Construction Program and registration visit the City's web site: <http://www.sandiego.gov>.
2. **RECEIPT AND OPENING OF BIDS:** Bids will be received at the Public Works Contracts at the location, time, and date shown on the cover of these specifications for performing work on **Solola & Euclid CR Obstruction DS** (Project).
3. **SUMMARY OF WORK:** The Work involves furnishing all labor, materials, equipment, services, and other incidental works and appurtenances for the construction of the Project as described in ATTACHMENT A.
4. **BIDS ARE PUBLIC RECORDS:** Upon receipt by the City, Bids shall become public records subject to public disclosure. It is the responsibility of the respondent to clearly identify any confidential, proprietary, trade secret or otherwise legally privileged information contained within the Bid. General references to sections of the California Public Records Act (PRA) will not suffice. If the Contractor does not provide applicable case law that clearly establishes that the requested information is exempt from the disclosure requirements of the PRA, the City shall be free to release the information when required in accordance with the PRA, pursuant to any other applicable law, or by order of any court or government agency, and the Contractor will hold the City harmless for release of this information.
5. **SUBCONTRACTING PARTICIPATION PERCENTAGES:**
 - 5.1. The City has incorporated voluntary subcontractor participation percentage to enhance competition and maximize subcontracting opportunities as follows.
 - 5.2. The following voluntary subcontractor participation percentage for DBE, DVBE, WBE, MBE, SLBE, and ELBE certified Subcontractors shall apply to this contract:

Total voluntary subcontractor participation percentage for this project is 23.7%.
 - 5.3. For additional Equal Opportunity Contracting Program requirements, see Attachment C.
6. **PRE-BID MEETING:**
 - 6.1. There will be a Pre-Bid Meeting to discuss the scope of the Project, bidding requirements, pre-qualification process, and Equal Opportunity Contracting Program requirements and reporting procedures in the Public Works Contracts, Conference Room at 1010 Second Avenue, 14th Floor, San Diego, CA 92101 at **10:00 AM**, on **DECEMBER 18, 2014**.
 - 6.2. All potential bidders are encouraged to attend.

- 6.3. To request a copy of the agenda on an alternative format, or to request a sign language or oral interpreter for this meeting, call the Public Works Contracts at (619) 533-3450 at least 5 Working Days prior to the Pre-Bid Meeting to ensure availability.
7. **CONTRACTOR REGISTRATION AND ELECTRONIC REPORTING SYSTEM:**
- 7.1. Prior to the Award of the Contract or each Task Order, you and your Subcontractors and Suppliers must register with the City’s web-based vendor registration and bid management system, BidsOnline™ hosted by PlanetBids System. For additional information go to:
<http://www.sandiego.gov/purchasing/bids-contracts/vendorreg.shtml>.
- 7.2. The City may not award the contract until registration of all subcontractors and suppliers is complete. In the event this requirement is not met within the time frame specified in the Notice of Intent to Award letter, the City reserves the right to rescind the Notice of Award / Intent to Award and to make the award to the next responsive and responsible bidder / proposer.
8. **JOINT VENTURE CONTRACTORS:** Provide a copy of the Joint Venture agreement and the Joint Venture license to the City within 10 Working Days after receiving the Contract forms. See 2-1.1.2, “Joint Venture Contractors” in The WHITEBOOK for details.
9. **PREVAILING WAGE RATES:** Pursuant to San Diego Municipal Code section 22.3019, construction, alteration, demolition, repair and maintenance work performed under this Contract is subject to State prevailing wage laws. For construction work performed under this Contract cumulatively exceeding \$25,000 and for alteration, demolition, repair and maintenance work performed under this Contract cumulatively exceeding \$15,000, the Contractor and its subcontractors shall comply with State prevailing wage laws including, but not limited to, the requirements listed below.
- 9.1. **Compliance with Prevailing Wage Requirements.** Pursuant to sections 1720 through 1861 of the California Labor Code, the Contractor and its subcontractors shall ensure that all workers who perform work under this Contract are paid not less than the prevailing rate of per diem wages as determined by the Director of the California Department of Industrial Relations (DIR). This includes work performed during the design and preconstruction phases of construction including, but not limited to, inspection and land surveying work.
- 9.2. Copies of such prevailing rate of per diem wages are on file at the City and are available for inspection to any interested party on request. Copies of the prevailing rate of per diem wages also may be found at <http://www.dir.ca.gov/OPRL/DPreWageDetermination.htm>. Contractor and its subcontractors shall post a copy of the prevailing rate of per diem wages determination at each job site and shall make them available to any interested party upon request.
- 9.3. The wage rates determined by the DIR refer to expiration dates. If the published wage rate does not refer to a predetermined wage rate to be paid after the expiration date, then the published rate of wage shall be in effect for the life of this Contract. If the published wage rate refers to a predetermined wage rate to become effective upon expiration of the published wage rate and the predetermined wage rate is on file with the DIR, such predetermined wage rate shall become effective on the date following the expiration date and shall apply to this Contract in the same manner as if it had

been published in said publication. If the predetermined wage rate refers to one or more additional expiration dates with additional predetermined wage rates, which expiration dates occur during the life of this Contract, each successive predetermined wage rate shall apply to this Contract on the date following the expiration date of the previous wage rate. If the last of such predetermined wage rates expires during the life of this Contract, such wage rate shall apply to the balance of the Contract.

- 9.4. Penalties for Violations.** Contractor and its subcontractors shall comply with California Labor Code section 1775 in the event a worker is paid less than the prevailing wage rate for the work or craft in which the worker is employed.
- 9.5. Payroll Records.** Contractor and its subcontractors shall comply with California Labor Code section 1776, which generally requires keeping accurate payroll records, verifying and certifying payroll records, and making them available for inspection. Contractor shall require its subcontractors to also comply with section 1776. Contractor and its subcontractors shall submit weekly certified payroll records online via the City's web-based Labor Compliance Program. Contractor is responsible for ensuring its subcontractors submit certified payroll records to the City.
- 9.6. Apprentices.** Contractor and its subcontractors shall comply with California Labor Code sections 1777.5, 1777.6 and 1777.7 concerning the employment and wages of apprentices. Contractor shall be held responsible for the compliance of their subcontractors with sections 1777.5, 1777.6 and 1777.7.
- 9.7. Working Hours.** Contractor and subcontractors shall comply with California Labor Code sections 1810 through 1815, including but not limited to: (i) restrict working hours on public works contracts to eight hours a day and forty hours a week, unless all hours worked in excess of 8 hours per day are compensated at not less than 1½ times the basic rate of pay; and (ii) specify penalties to be imposed on design professionals and subcontractors of \$25 per worker per day for each day the worker works more than 8 hours per day and 40 hours per week in violation of California Labor Code sections 1810 through 1815.
- 9.8. Required Provisions for Subcontracts.** Contractor shall include at a minimum a copy of the following provisions in any contract they enter into with a subcontractor: California Labor Code sections 1771, 1775, 1776, 1777.5, 1810, 1813, 1815, 1860 and 1861.
- 9.9. Labor Code Section 1861 Certification.** Contractor in accordance with California Labor Code section 3700 is required to secure the payment of compensation of its employees and by signing this Contract, Contractor certifies that "I am aware of the provisions of Section 3700 of the California Labor Code which require every employer to be insured against liability for workers' compensation or to undertake self-insurance in accordance with the provisions of that code, and I will comply with such provisions before commencing the performance of the work of this Contract."
- 9.10. Labor Compliance Program.** The City has its own Labor Compliance Program as authorized by the DIR. The City will withhold contract payments when payroll records are delinquent or deemed inadequate by the City or other governmental entity, or it has been established after an investigation by the City or other governmental entity that underpayment(s) have occurred.

10. INSURANCE REQUIREMENTS:

- 10.1.** All certificates of insurance and endorsements required by the contract are to be provided upon issuance of the City's Notice of Intent to Award letter.

10.2. Refer to sections 7-3, “LIABILITY INSURANCE”, and 7-4, “WORKERS’ COMPENSATION INSURANCE” of the Supplementary Special Provisions (SSP) for the insurance requirements which must be met.

11. PREQUALIFICATION OF CONTRACTORS:

11.1. Contractors submitting Bid must be pre-qualified for the total amount proposed, inclusive of all alternate items prior to the date of submittal. Bids from contractors who have not been pre-qualified as applicable and Bids that exceed the maximum dollar amount at which contractors are pre-qualified will be deemed **non-responsive** and ineligible for award. Complete information and prequalification questionnaires are available at:

<http://www.sandiego.gov/cip/bidopps/prequalification.shtml>

11.2. The completed questionnaire, financial statement, and bond letter or a copy of the contractor’s SLBE-ELBE certification and bond letter, must be submitted no later than 2 weeks prior to the bid opening to the Public Works Contracts, Prequalification Program, 1010 Second Avenue, 14th Floor, San Diego, CA 92101. For additional information or the answer to questions about the prequalification program, contact David Stucky at 619-533-3474 or dstucky@sandiego.gov.

12. REFERENCE STANDARDS: Except as otherwise noted or specified, the Work shall be completed in accordance with the following standards:

Title	Edition	Document Number
Standard Specifications for Public Works Construction (“The GREENBOOK”)	2012	PITS070112-01
City of San Diego Standard Specifications for Public Works Construction (“The WHITEBOOK”)*	2012	PITS070112-02
City of San Diego Standard Drawings*	2012	PITS070112-03
Caltrans Standard Specifications	2010	PITS070112-04
Caltrans Standard Plans	2010	PITS070112-05
California MUTCD	2012	PITS070112-06
City Standard Drawings - Updates Approved For Use (when specified)*	Varies	Varies
Standard Federal Equal Employment Opportunity Construction Contract Specifications and the Equal Opportunity Clause Dated 09-11-84	1984	769023
NOTE: *Available online under Engineering Documents and References at: http://www.sandiego.gov/publicworks/edocref/index.shtml		

13. CITY’S RESPONSES AND ADDENDA: The City at its option, may respond to any or all questions submitted in writing, via letter, or FAX in the form of an addendum. No oral comment shall be of any force or effect with respect to this solicitation. The changes to the Contract Documents through addendum are made effective as though originally issued with the Bid. The Bidders shall acknowledge the receipt of Addenda on the form provided for this purpose in the Bid.

- 14. CITY'S RIGHTS RESERVED:** The City reserves the right to cancel the Notice Inviting Bids at any time, and further reserves the right to reject submitted Bids, without giving any reason for such action, at its sole discretion and without liability. Costs incurred by the Bidder(s) as a result of preparing Bids under the Notice Inviting Bids shall be the sole responsibility of each bidder. The Notice Inviting Bids creates or imposes no obligation upon the City to enter a contract.
- 15. CONTRACT PRICING FORMAT:** This solicitation is for a Lump Sum contract with Unit Price provisions as set forth in the Bid Proposal Form(s), Volume 2.
- 16. SUBMITTAL OF "OR EQUAL" ITEMS:** See Section 4-1.6, "Trade Names or Equals" in The WHITEBOOK and as amended in the SSP.
- 17. AWARD PROCESS:**
- 17.1.** The Award of this contract is contingent upon the Contractor's compliance with all conditions precedent to Award.
- 17.2.** Upon acceptance of a Bid, the City will prepare contract documents for execution within approximately 21 days of the date of the Bid opening and award the Contract approximately within 7 days of receipt of properly executed Contract, bonds, and insurance documents.
- 17.3.** This contract will be deemed executed, and effective, only upon the signing of the Contract by the Mayor or designee of the City.
- 18. SUBCONTRACT LIMITATIONS:** The Bidder's attention is directed to Standard Specifications for Public Works Construction, Section 2-3, "SUBCONTRACTS" in The GREENBOOK and as amended in the SSP which requires the Contractor to self-perform not less than the amount specified. Failure to comply with this requirement shall render the Bid **non-responsive** and ineligible for award.
- 19. AVAILABILITY OF PLANS AND SPECIFICATIONS:** Contract Documents may be obtained by visiting the City's website: <http://www.sandiego.gov/cip/>. Plans and Specifications for this contract are also available for review in the office of the City Clerk or Public Works Contracts.
- 20. SUBMISSION OF QUESTIONS:**
- 20.1.** The Director (or designee), of the Public Works Department is the officer responsible for opening, examining, and evaluating the competitive Bids submitted to the City for the acquisition, construction and completion of any public improvement except when otherwise set forth in these documents. All questions related to this solicitation shall be submitted to:
- Public Works Contracts
1010 Second Avenue, 14th Floor
San Diego, California, 92101
Attention: [Contract Specialist listed on the front cover hereof]
- OR:
- Email address of the Contract Specialist listed on the front cover hereof.

- 20.2. Questions received less than 14 days prior to the date for opening of Bids may not be considered.
- 20.3. Clarifications deemed by the City to be material shall be issued by Addenda and uploaded to the City's online bidding service.
- 20.4. Only questions answered by formal written addenda will be binding. Oral and other interpretations or clarifications will be without legal effect. It is the Bidder's responsibility to become informed of any Addenda that have been issued and to include all such information in its Bid.
21. **ELIGIBLE BIDDERS:** No person, firm, or corporation shall be allowed to make, file, or be interested in **more** than one (1) Bid for the same work unless alternate Bids are called for. A person, firm or corporation who has submitted a sub-proposal to a Bidder, or who has quoted prices on materials to a Bidder, is not hereby disqualified from submitting a sub-proposal or quoting prices to other Bidders or from submitting a Bid in its own behalf. Any Bidder who submits more than one bid will result in the rejection of all bids submitted.
22. **SAN DIEGO BUSINESS TAX CERTIFICATE:** The Contractor and Subcontractors, not already having a City of San Diego Business Tax Certificate for the work contemplated shall secure the appropriate certificate from the City Treasurer, Civic Center Plaza, first floor and submit to the Contract Specialist upon request or as specified in the Contract Documents. Tax Identification numbers for both the Bidder and the listed Subcontractors must be submitted on the City provided forms with the Notice Inviting Bids and Contract forms.
23. **PROPOSAL FORMS:** Bid shall be made only upon the Bidding Documents i.e., Proposal form attached to and forming a part of the specifications. The signature of each person signing shall be in longhand.
- 23.1. Bidder shall complete and submit all pages in the "Bidding Document" Section (see Volume 2) as their Bid per the schedule given under "Required Documents Schedule," (see Volume 1). Bidder is requested to retain for their reference other portions of the Contract Documents that are not required to be submitted with the Bid. The entire specifications for the bid package do not need to be submitted with the bid.
- 23.2. The City may require any Bidder to furnish a statement of experience, financial responsibility, technical ability, equipment, and references.
- 23.3. Bids and certain other forms and documents as specified in the Volume 2 of 2 of the Contract Documents shall be enclosed in a sealed envelope and shall bear the title of the work and name of the Bidder and the appropriate State Contractors License designation which the Bidder holds.
- 23.4. Bids may be withdrawn by the Bidder prior to, but not after, the time fixed for opening of Bids.
24. **BIDDER'S GUARANTEE OF GOOD FAITH (BID SECURITY):**
- 24.1. With the exception of the contracts valued \$5,000 or less, JOC and Design-Build contracts, and contracts subject to the Small and Local Business Program of \$250,000 or less e.g., ELBE contracts, each Bidder shall accompany its Bid with either a cashier's

check upon some responsible bank, or a check upon such bank properly certified or an approved corporate surety bond payable to the City of San Diego, for an amount of not less than 10% of the aggregate sum of the Bid, which check or bond, and the monies represented thereby shall be held by the City as a guarantee that the Bidder, if awarded the contract, will in good faith enter into such contract and furnish the required final bonds.

24.2. The Bidder agrees that in case of Bidder's refusal or failure to execute this contract and give required final bonds, the money represented by a cashier's or certified check shall remain the property of the City, and if the Bidder shall fail to execute this contract, the Surety agrees that it will pay to the City damages which the City may suffer by reason of such failure, not exceeding the sum of 10% of the amount of the Bid.

24.3. A Bid received without the specified bid security will be rejected as being **non-responsive**.

25. AWARD OF CONTRACT OR REJECTION OF BIDS:

25.1. This contract may be awarded to the lowest responsible and reliable Bidder.

25.2. Bidders shall complete the entire Bid schedule (also referred to as "schedule of prices" or Proposal form). Incomplete price schedules will be rejected as being non-responsive.

25.3. The City reserves the right to reject any or all Bids, and to waive any informality or technicality in Bids received and any requirements of these specifications as to bidding procedure.

25.4. Bidders will not be released on account of their errors of judgment. Bidders may be released only upon receipt by the City from the Bidder within 3 Working Days, excluding Saturdays, Sundays, and state holidays, after the opening of Bids, of written notice which includes proof of honest, credible, clerical error of material nature, free from fraud or fraudulent intent, and of evidence that reasonable care was observed in the preparation of the Bid.

25.5. A non-selected Bidder may protest award of the Contract to the selected Bidder by submitting a written "Notice of Intent to Protest" including supporting documentation which shall be received by Public Works Contracts no later than 10 days after the City's announcement of the selected Bidder or no later than 10 days from the date that the City issues notice of designation of a Bidder as non-responsive in accordance with San Diego Municipal Code Chapter 2, § 22.3029, "Protests of Contract Award."

25.6. The City of San Diego will not discriminate with regard to race, religious creed, color, national origin, ancestry, physical handicap, marital status, sex or age, in the award of contracts.

25.7. Each Bid package properly executed as required by these specifications shall constitute a firm offer, which may be accepted by the City within the time specified in the Proposal.

25.8. The City reserves the right to evaluate all Bids and determine the lowest Bidder on the basis of any proposed alternates, additive items or options, at its discretion that will be disclosed in the Volume 2 of 2.

26. BID RESULTS:

- 26.1.** The Bid opening by the City shall constitute the public announcement of the Apparent Low Bidder. In the event that the Apparent Low Bidder is subsequently deemed non-responsive or non-responsible, a public announcement will be posted in the City's web page <http://www.sandiego.gov/cip/index.shtml>, with the name of the newly designated Apparent Low Bidder.
- 26.2.** To obtain Bid results, either attend Bid opening, review the results on the City's web site, or provide a self-addressed, stamped envelope, referencing Bid number, and Bid tabulation will be mailed to you upon verification of extensions. Bid results cannot be given over the telephone.

27. THE CONTRACT:

- 27.1.** The Bidder to whom award is made shall execute a written contract with the City of San Diego and furnish good and approved bonds and insurance certificates specified by the City within 14 days after receipt by Bidder of a form of contract for execution unless an extension of time is granted to the Bidder in writing.
- 27.2.** If the Bidder takes longer than 14 days to fulfill these requirements, then the additional time taken shall be added to the Bid guarantee. The Contract shall be made in the form adopted by the City, which includes the provision that no claim or suit whatsoever shall be made or brought by Contractor against any officer, agent, or employee of the City for or on account of anything done or omitted to be done in connection with this contract, nor shall any such officer, agent, or employee be liable hereunder.
- 27.3.** If the Bidder to whom the award is made fails to enter into the contract as herein provided, the award may be annulled and the Bidder's Guarantee of Good Faith will be subject to forfeiture. An award may be made to the next lowest responsible and reliable Bidder who shall fulfill every stipulation embraced herein as if it were the party to whom the first award was made.
- 27.4.** Pursuant to the San Diego City Charter section 94, the City may only award a public works contract to the lowest responsible and reliable Bidder. The City will require the Apparent Low Bidder to (i) submit information to determine the Bidder's responsibility and reliability, (ii) execute the Contract in form provided by the City, and (iii) furnish good and approved bonds and insurance certificates specified by the City within 14 Days, unless otherwise approved by the City, in writing after the Bidder receives notification from the City, designating the Bidder as the Apparent Low Bidder and formally requesting the above mentioned items.
- 27.5.** The award of the Contract is contingent upon the satisfactory completion of the above mentioned items and becomes effective upon the signing of the Contract by the Mayor or designee. If the Apparent Low Bidder does not execute the Contract or submit required documents and information, the City may award the Contract to the next lowest responsible and reliable Bidder who shall fulfill every condition precedent to award. A corporation designated as the Apparent Low Bidder shall furnish evidence of its corporate existence and evidence that the officer signing the Contract and bond for the corporation is duly authorized to do so.

- 28. EXAMINATION OF PLANS, SPECIFICATIONS, AND SITE OF WORK:** The Bidder shall examine carefully the Project Site, the Plans and Specifications, other materials as described in the Special Provisions, Section 2-7, and the proposal forms (e.g., Bidding Documents). The submission of a Bid shall be conclusive evidence that the Bidder has investigated and is satisfied as to the conditions to be encountered, as to the character, quality, and scope of Work, the quantities of materials to be furnished, and as to the requirements of the Bidding Documents Proposal, Plans, and Specifications.
- 29. CITY STANDARD PROVISIONS:** This contract is subject to the following standard provisions. See The WHITEBOOK for details.
- 29.1.** The City of San Diego Resolution No. R-277952 adopted on May 20, 1991 for a Drug-Free Workplace.
- 29.2.** The City of San Diego Resolution No. R-282153 adopted on June 14, 1993 related to the Americans with Disabilities Act.
- 29.3.** The City of San Diego Municipal Code §22.3004 for Pledge of Compliance.
- 29.4.** The City of San Diego’s Labor Compliance Program and the State of California Labor Code §§1771.5(b) and 1776.
- 29.5.** Sections 1777.5, 1777.6, and 1777.7 of the State of California Labor Code concerning the employment of apprentices by contractors and subcontractors performing public works contracts.
- 29.6.** The City’s Equal Benefits Ordinance (EBO), Chapter 2, Article 2, Division 43 of The San Diego Municipal Code (SDMC).
- 29.7.** The City’s Information Security Policy (ISP) as defined in the City’s Administrative Regulation 90.63.
- 30. PRE-AWARD ACTIVITIES:**
- 30.1.** The selected contractor by the City to execute a contract for this Work shall provide the information required within the time specified in “Required Documents,” of this bid package. Failure to provide the information within the time specified may result in the Bid being rejected as **non-responsive**.
- 30.2.** If the Bid is rejected as non-responsive, the selected contractor by the City to execute a contract for this Work shall forfeit the required Bid. The decision that the selected contractor by the City to execute a contract for this Work is non-responsive for failure to provide the information required within the time specified shall be at the sole discretion of the City.
- 31. REQUIRED DOCUMENT SCHEDULE:**
- 31.1.** The Bidder’s attention is directed to the City’s Municipal Code §22.0807(e), (3)-(5) for important information regarding grounds for debarment for failure to submit required documentation.

31.2. The specified Equal Opportunity Contracting Program (EOCP) forms are available for download from the City's web site at:

<http://www.sandiego.gov/eoc/forms/index.shtml>

ITEM	WHEN DUE	FROM	DOCUMENT TO BE SUBMITTED
1.	BID SUBMITTAL DATE/TIME	ALL BIDDERS	Bid
2.	BID SUBMITTAL DATE/TIME	ALL BIDDERS	Non-collusion Affidavit to be Executed By Bidder and Submitted with Bid under 23 USC 112 and PCC 7106
3.	BID SUBMITTAL DATE/TIME	ALL BIDDERS	Contractors Certification of Pending Actions
4.	BID SUBMITTAL DATE/TIME	ALL BIDDERS	Equal Benefits Ordinance Certification of Compliance
5.	BID SUBMITTAL DATE/TIME	ALL BIDDERS	Form AA35 - List of Subcontractors
6.	BID SUBMITTAL DATE/TIME	ALL BIDDERS	Form AA40 - Named Equipment/Material Supplier List
7.	WITHIN 10 WORKING DAYS AFTER RECEIPT BY BIDDER OF CONTRACT FORMS	APPARENT LOW BIDDER	Names of the principal individual owners of the Apparent Low Bidder
8.	WITHIN 10 WORKING DAYS AFTER RECEIPT BY BIDDER OF CONTRACT FORMS	APPARENT LOW BIDDER	If the Contractor is a Joint Venture: <ul style="list-style-type: none"> • Joint Venture Agreement • Joint Venture License
9.	WITHIN 10 WORKING DAYS AFTER RECEIPT BY BIDDER OF CONTRACT FORMS	APPARENT LOW BIDDER	Form BB05 - Work Force Report
10.	WITHIN 10 WORKING DAYS AFTER RECEIPT BY BIDDER OF CONTRACT FORMS	APPARENT LOW BIDDER	Contract Forms - Agreement
11.	WITHIN 10 WORKING DAYS AFTER RECEIPT BY BIDDER OF CONTRACT FORMS	APPARENT LOW BIDDER	Contract Forms - Payment and Performance Bond
12.	WITHIN 10 WORKING DAYS AFTER RECEIPT BY BIDDER OF CONTRACT FORMS	APPARENT LOW BIDDER	Certificates of Insurance and Endorsements
13.	WITHIN 10 WORKING DAYS AFTER RECEIPT BY BIDDER OF CONTRACT FORMS	APPARENT LOW BIDDER	Contractor Certification - Drug-Free Workplace
14.	WITHIN 10 WORKING DAYS AFTER RECEIPT BY BIDDER OF CONTRACT FORMS	APPARENT LOW BIDDER	Contractor Certification - American with Disabilities Act
15.	WITHIN 10 WORKING DAYS AFTER RECEIPT BY BIDDER OF CONTRACT FORMS	APPARENT LOW BIDDER	Contractors Standards - Pledge of Compliance

CONTRACT FORMS

CONSTRUCTION CONTRACT

This contract is made and entered into between THE CITY OF SAN DIEGO, a municipal corporation, herein called "City", and New Century Construction, Inc., herein called "Contractor" for construction of Solola & Euclid CR Obstruction DS; Bid No. L-15-1212-DBB-1; in the amount of One Hundred Thirty-Eight Thousand Seven Hundred Seventy-Three and .60/100 (\$138,773.60), which is comprised of the Base Bid Only.

IN CONSIDERATION of the payments to be made hereunder and the mutual undertakings of the parties hereto, City and Contractor agree as follows:

1. The following are incorporated into this contract as though fully set forth herein:
 - (a) The attached Faithful Performance and Payment Bonds.
 - (b) The attached Proposal included in the Bid documents by the Contractor.
 - (c) Reference Standards listed in the Notice Inviting Bids and the Supplementary Special Provisions (SSP).
 - (d) That certain documents entitled Solola & Euclid CR Obstruction DS, on file in the office of the Public Works Department as Document No. L-15-1212-DBB-1, as well as all matters referenced therein.
2. The Contractor shall perform and be bound by all the terms and conditions of this contract and in strict conformity therewith shall perform and complete in a good and workmanlike manner Solola & Euclid CR Obstruction DS, Bid Number L-15-1212-DBB-1, San Diego, California.
3. For such performances, the City shall pay to Contractor the amounts set forth at the times and in the manner and with such additions or deductions as are provided for in this contract, and the Contractor shall accept such payment in full satisfaction of all claims incident to such performances.
4. No claim or suit whatsoever shall be made or brought by Contractor against any officer, agent, or employee of the City for or on account of anything done or omitted to be done in connection with this contract, nor shall any such officer, agent, or employee be liable hereunder.
5. This contract is effective as of the date that the Mayor or designee signs the agreement.

CONTRACT FORMS (continued)

IN WITNESS WHEREOF, this Agreement is signed by the City of San Diego, acting by and through its Mayor or designee, pursuant to or **Municipal Code 22.3107** authorizing such execution.

THE CITY OF SAN DIEGO

APPROVED AS TO FORM

Jan I. Goldsmith, City Attorney

By 

By 

Print Name: Stephen Samara,
Senior Contract Specialist

Print Name: Jeremy Jung
Deputy City Attorney

Date: 3-16-17

Date: 3-16-15

CONTRACTOR

By 

Print Name: LEE P. SHELBERG, II

Title: PRESIDENT

Date: 1-28-15

City of San Diego License No.: B1999008488

State Contractor's License No.: 614517

**CONTRACT FORMS
ATTACHMENTS**

This Bond was Executed in
Three (3) Identical Counterparts

THE FINAL PREMIUM IS
PREDICATED ON THE
FINAL CONTRACT PRICE

Bond No. 4399255
Premium: \$1,888.00

CONTRACT FORMS ATTACHMENTS
PERFORMANCE BOND AND LABOR AND MATERIALMEN'S BOND

FAITHFUL PERFORMANCE BOND AND LABOR AND MATERIALMEN'S BOND:

New Century Construction, Inc., a corporation, as principal, and
SureTec Insurance Company, a corporation authorized to do
business in the State of California, as Surety, hereby obligate themselves, their successors and
assigns, jointly and severally, to The City of San Diego a municipal corporation in the sum of
* _____ for the faithful performance of the
annexed contract, and in the sum of * _____ for the
benefit of laborers and materialmen designated below.

*One Hundred Thirty Eight Thousand Seven Hundred Seventy Three and 60/100 (\$138,773.60)

Conditions:

If the Principal shall faithfully perform the annexed contract Solola & Euclid CR
Obstruction DS, Bid Number L-15-1212-DBB-1, San Diego, California then the obligation herein
with respect to a faithful performance shall be void; otherwise it shall remain in full force.

If the Principal shall promptly pay all persons, firms and corporations furnishing materials for
or performing labor in the execution of this contract, and shall pay all amounts due under the
California Unemployment Insurance Act then the obligation herein with respect to laborers and
materialmen shall be void; otherwise it shall remain in full force.

The obligation herein with respect to laborers and materialmen shall inure to the benefit of all
persons, firms and corporations entitled to file claims under the provisions of Chapter 3 of Division 5
of Title I of the Government Code of the State of California or under the provisions of Section 3082
et seq. of the Civil Code of the State of California.

Changes in the terms of the annexed contract or specifications accompanying same or
referred to therein shall not affect the Surety's obligation on this bond, and the Surety hereby waives
notice of same.

CONTRACT FORMS ATTACHMENTS (continued)
PERFORMANCE BOND AND LABOR AND MATERIALMEN'S BOND

The Surety shall pay reasonable attorney's fees should suit be brought to enforce the provisions of this bond.

Dated January 27th, 2015

Approved as to Form

New Century Construction, Inc.

Principal

By 

LEE P. SHELBURG, A

Printed Name of Person Signing for Principal

Jan I. Goldsmith, City Attorney

By 
Deputy City Attorney

SureTec Insurance Company

Surety

By 

Attorney-in-fact Dwight Reilly

Approved:

By 
Mayor or Designee

3033 5th Avenue, Suite 300

Local Address of Surety

San Diego, CA 92103

Local Address (City, State) of Surety

(800) 288-0351

Local Telephone No. of Surety

Premium \$ 1,888.00

Bond No. 4399255

ACKNOWLEDGMENT

A notary public or other officer completing this certificate verifies only the identity of the individual who signed the document to which this certificate is attached, and not the truthfulness, accuracy, or validity of that document.

State of California
County of Orange)

On January 27, 2015 before me, Karen L. Ritto, Notary Public
(insert name and title of the officer)

personally appeared Dwight Reilly
who proved to me on the basis of satisfactory evidence to be the person(s) whose name(s) is/~~are~~
subscribed to the within instrument and acknowledged to me that he/~~she/they~~ executed the same in
his/~~her/their~~ authorized capacity(~~ies~~), and that by his/~~her/their~~ signature(s) on the instrument the
person(s), or the entity upon behalf of which the person(s) acted, executed the instrument.

I certify under PENALTY OF PERJURY under the laws of the State of California that the foregoing paragraph is true and correct.

CALIFORNIA ALL-PURPOSE ACKNOWLEDGEMENT

A notary public or other officer completing this certificate verifies only the identity of the individual who signed the document to which this certificate is attached, and not the truthfulness, accuracy, or validity of that document.

State of California
County of (San Diego)

On 1-28-15 before me, Susan Leggitt, Notary Public
(insert name and title of the officer)

personally appeared Lee P. Shellberg II who proved to me on the basis
of satisfactory evidence to be the person(s) whose name(s) is/are subscribed to the within instrument and acknowledged to me that
he/~~she/they~~ executed the same in his/~~her/their~~ authorized capacity(~~ies~~), and that by his/~~her/their~~ signature(s) on the instrument the
person(s), or the entity upon behalf of which the person(s) acted, executed the instrument.

I certify under PENALTY OF PERJURY under the laws of the State of California that the foregoing paragraph is true and correct.

WITNESS my hand and official seal.

Signature *Susan Leggitt* (Seal)
Susan Leggitt, Notary Public



SureTec Insurance Company

Bond No. 4399255

LIMITED POWER OF ATTORNEY

Know All Men by These Presents, That SURETEC INSURANCE COMPANY (the "Company"), a corporation duly organized and existing under the laws of the State of Texas, and having its principal office in Houston, Harris County, Texas, does by these presents make, constitute and appoint

Arturo Ayala, Daniel Huckabay, Dwight Reilly, Andrew Waterbury

its true and lawful Attorney-in-fact, with full power and authority hereby conferred in its name, place and stead, to execute, acknowledge and deliver any and all bonds, recognizances, undertakings or other instruments or contracts of suretyship to include waivers to the conditions of contracts and consents of surety for:

Five Million and 00/100 Dollars (\$5,000,000.00)

and to bind the Company thereby as fully and to the same extent as if such bond were signed by the President, sealed with the corporate seal of the Company and duly attested by its Secretary, hereby ratifying and confirming all that the said Attorney-in-Fact may do in the premises. Said appointment shall continue in force until 10/31/2016 and is made under and by authority of the following resolutions of the Board of Directors of the SureTec Insurance Company:

Be it Resolved, that the President, any Vice-President, any Assistant Vice-President, any Secretary or any Assistant Secretary shall be and is hereby vested with full power and authority to appoint any one or more suitable persons as Attorney(s)-in-Fact to represent and act for and on behalf of the Company subject to the following provisions:

Attorney-in-Fact may be given full power and authority for and in the name of and of behalf of the Company, to execute, acknowledge and deliver, any and all bonds, recognizances, contracts, agreements or indemnity and other conditional or obligatory undertakings and any and all notices and documents canceling or terminating the Company's liability thereunder, and any such instruments so executed by any such Attorney-in-Fact shall be binding upon the Company as if signed by the President and sealed and effected by the Corporate Secretary.

Be it Resolved, that the signature of any authorized officer and seal of the Company heretofore or hereafter affixed to any power of attorney or any certificate relating thereto by facsimile, and any power of attorney or certificate bearing facsimile signature or facsimile seal shall be valid and binding upon the Company with respect to any bond or undertaking to which it is attached. (Adopted at a meeting held on 20th of April, 1999.)

In Witness Whereof, SURETEC INSURANCE COMPANY has caused these presents to be signed by its President, and its corporate seal to be hereto affixed this 21st day of March, A.D. 2013.

SURETEC INSURANCE COMPANY

By: 
John Knox Jr., President



State of Texas ss:
County of Harris

On this 21st day of March, A.D. 2013 before me personally came John Knox Jr., to me known, who, being by me duly sworn, did depose and say, that he resides in Houston, Texas, that he is President of SURETEC INSURANCE COMPANY, the company described in and which executed the above instrument; that he knows the seal of said Company; that the seal affixed to said instrument is such corporate seal; that it was so affixed by order of the Board of Directors of said Company; and that he signed his name thereto by like order.

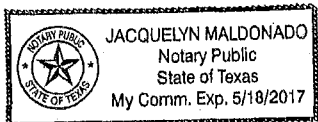

Jacquelyn Maldonado, Notary Public
My commission expires May 18, 2017

I, M. Brent Beaty, Assistant Secretary of SURETEC INSURANCE COMPANY, do hereby certify that the above and foregoing is a true and correct copy of a Power of Attorney, executed by said Company, which is still in full force and effect; and furthermore, the resolutions of the Board of Directors, set out in the Power of Attorney are in full force and effect.

Given under my hand and the seal of said Company at Houston, Texas this 27th day of January, 2015, A.D.

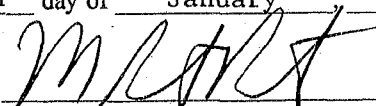
M. Brent Beaty, Assistant Secretary

Any instrument issued in excess of the penalty stated above is totally void and without any validity.
For verification of the authority of this power you may call (713) 812-0800 any business day between 8:00 am and 5:00 pm CST.

CONTRACTOR CERTIFICATION

DRUG-FREE WORKPLACE

PROJECT TITLE: Solola & Euclid CR Obstruction DS

I hereby certify that I am familiar with the requirements of San Diego City Council Policy No. 100-17 regarding Drug-Free Workplace as outlined in the WHITEBOOK, Section 7-13.3, "Drug-Free Workplace", of the project specifications, and that;

NEW CENTURY CONSTRUCTION, INC.
(Name under which business is conducted)

has in place a drug-free workplace program that complies with said policy. I further certify that each subcontract agreement for this project contains language which indicates the subcontractor's agreement to abide by the provisions of subdivisions a) through c) of the policy as outlined.

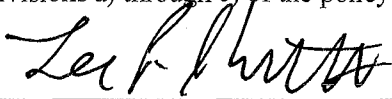
Signed 

Printed Name LEE P. SHELLBERG, II

Title PRESIDENT

CONTRACTOR CERTIFICATION

AMERICAN WITH DISABILITIES ACT (ADA) COMPLIANCE CERTIFICATION

PROJECT TITLE: Solola & Euclid CR Obstruction DS

I hereby certify that I am familiar with the requirements of San Diego City Council Policy No. 100-4 regarding the American With Disabilities Act (ADA) outlined in the WHITEBOOK, Section 7-13.2, "American With Disabilities Act", of the project specifications, and that;

NEW CENTURY CONSTRUCTION, INC.

(Name under which business is conducted)

has in place a workplace program that complies with said policy. I further certify that each subcontract agreement for this project contains language which indicates the subcontractor's agreement to abide by the provisions of the policy as outlined.

Signed

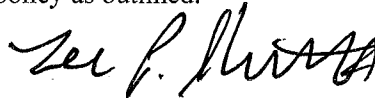

Printed Name

LEE P. SHELBURG, II

Title

PRESIDENT

CONTRACTOR CERTIFICATION

CONTRACTOR STANDARDS – PLEDGE OF COMPLIANCE

PROJECT TITLE: Solola & Euclid CR Obstruction DS

I declare under penalty of perjury that I am authorized to make this certification on behalf of NEW CENTURY CONSTRUCTION, INC., as Contractor, that I am familiar with the requirements of City of San Diego Municipal Code § 22.3224 regarding Contractor Standards as outlined in the WHITEBOOK, Section 7-13.4, ("Contractor Standards"), of the project specifications, and that Contractor has complied with those requirements.

I further certify that each of the Contractor's subcontractors whose subcontracts are greater than \$50,000 in value has completed a Pledge of Compliance attesting under penalty of perjury of having complied with City of San Diego Municipal Code § 22.3224.

Dated this 28 Day of JAN, 2015.

Signed Lee P. Smellberg II

Printed Name LEE P. SMELBERG II

Title PRESIDENT

AFFIDAVIT OF DISPOSAL

WHEREAS, on the _____ DAY OF _____, 2____ the undersigned entered into and executed a contract with the City of San Diego, a municipal corporation, for:

Solola & Euclid CR Obstruction DS

(Name of Project)

as particularly described in said contract and identified as Bid No. **L-15-1212-DBB-1**; SAP No. (WBS/IO/CC) **B-13069**; and **WHEREAS**, the specification of said contract requires the Contractor to affirm that "all brush, trash, debris, and surplus materials resulting from this project have been disposed of in a legal manner"; and **WHEREAS**, said contract has been completed and all surplus materials disposed of:

NOW, THEREFORE, in consideration of the final payment by the City of San Diego to said Contractor under the terms of said contract, the undersigned Contractor, does hereby affirm that all surplus materials as described in said contract have been disposed of at the following location(s)

and that they have been disposed of according to all applicable laws and regulations.

Dated this _____ DAY OF _____, _____.

Contractor
by

ATTEST:

State of _____
County of _____

On this _____ DAY OF _____, 2____, before the undersigned, a Notary Public in and for said County and State, duly commissioned and sworn, personally appeared _____ known to me to be the _____ Contractor named in the foregoing Release, and whose name is subscribed thereto, and acknowledged to me that said Contractor executed the said Release.

Notary Public in and for said County and State

COMPANY LETTERHEAD

CERTIFICATE OF COMPLIANCE

Materials and Workmanship Compliance

For Contract or Task _____

I certify that the material listed below complies with the materials and workmanship requirements of the Caltrans Contract Plans, Special Provisions, Standard Specifications, and Standard Plans for the contract listed above.

I also certify that I am an official representative for _____, the manufacturer of the material listed above. Furthermore, I certify that where California test methods, physical or chemical test requirements are part of the specifications, that the manufacturer has performed the necessary quality control to substantiate this certification.

Material Description:

Manufacturer: _____
Model: _____
Serial Number (if applicable) _____
Quantity to be supplied: _____
Remarks: _____

Signed by: _____

Printed Name: _____

Title: _____

Company: _____

Date: _____

ATTACHMENTS

ATTACHMENT A

SCOPE OF WORK

SCOPE OF WORK

1. **SCOPE OF WORK:** Installation of new curb ramps, pedestrian access route through NE & NW medians, traffic signal modifications, installation of new ADA pushbutton stub poles and installation of new sidewalk on south side of Solola Ave.
 - 1.1. The Work shall be performed in accordance with:
 - 1.1.1. The Notice Inviting Bids and Plans numbered **37724-01-D** through **37724-05-D**, inclusive.
2. **CONSTRUCTION COST:** The City's estimated construction cost for this contract is **\$123,000**
3. **LOCATION OF WORK:** The location of the Work is as follows:

See Appendix E, Location Map.
4. **CONTRACT TIME:** The Contract Time for completion of the Work shall be **51 Working Days**.
5. **CONTRACTOR'S LICENSE CLASSIFICATION:** In accordance with the provisions of California Law, the Contractor shall possess valid appropriate license(s) at the time that the Bid is submitted. Failure to possess the specified license(s) shall render the Bid as **non-responsive** and shall act as a bar to award of the Contract to any Bidder not possessing required license(s) at the time of Bid.
 - 5.1. The City has determined the following licensing classification for this contract:
 - CLASS A

ATTACHMENT B

INTENTIONALLY LEFT BLANK

ATTACHMENT C

EQUAL OPPORTUNITY CONTRACTING PROGRAM

EQUAL OPPORTUNITY CONTRACTING PROGRAM

1. To The WHITEBOOK, Chapter 10, Sections D and E, DELETE each in its entirety, and SUBSTITUTE with the following:

D. CITY'S EQUAL OPPORTUNITY COMMITMENT.

1. Nondiscrimination in Contracting Ordinance.

1. The Contractor, Subcontractors and Suppliers shall comply with requirements of the City's Nondiscrimination in Contracting Ordinance, San Diego Municipal Code §§22.3501 through 22.3517.

The Contractor shall not discriminate on the basis of race, gender, religion, national origin, ethnicity, sexual orientation, age, or disability in the solicitation, selection, hiring, or treatment of subcontractors, vendors, or suppliers. The Contractor shall provide equal opportunity for subcontractors to participate in subcontracting opportunities. The Contractor understands and agrees that violation of this clause shall be considered a material breach of the contract and may result in contract termination, debarment, or other sanctions.

The Contractor shall include the foregoing clause in all contracts between the Contractor and Subcontractors and Suppliers.

2. Disclosure of Discrimination Complaints. As part of its Bid or Proposal, the Bidder shall provide to the City a list of all instances within the past 10 years where a complaint was filed or pending against Bidder in a legal or administrative proceeding alleging that Bidder discriminated against its employees, subcontractors, vendors, or suppliers, and a description of the status or resolution of that complaint, including any remedial action taken.
3. Upon the City's request, the Contractor agrees to provide to the City, within 60 days, a truthful and complete list of the names of all Subcontractors and Suppliers that the Contractor has used in the past 5 years on any of its contracts that were undertaken within San Diego County, including the total dollar amount paid by the Contractor for each subcontract or supply contract.
4. The Contractor further agrees to fully cooperate in any investigation conducted by the City pursuant to the City's Nondiscrimination in Contracting Ordinance, Municipal Code §§22.3501 through 22.3517. The Contractor understands and agrees that violation of this clause shall be considered a material breach of the Contract and may result in remedies being ordered against the Contractor up to and including contract termination, debarment and other sanctions for violation of the provisions of the Nondiscrimination in Contracting Ordinance. The Contractor further understands and agrees that the procedures, remedies and sanctions provided for in the Nondiscrimination in Contracting Ordinance apply only to violations of the Ordinance.

E. EQUAL EMPLOYMENT OPPORTUNITY OUTREACH PROGRAM.

1. The Contractor, Subcontractors and Suppliers shall comply with the City's Equal Employment Opportunity Outreach Program, San Diego Municipal Code §§22.2701 through 22.2707.

The Contractor shall not discriminate against any employee or applicant for employment on any basis prohibited by law. Contractor shall provide equal opportunity in all employment practices. Prime Contractor shall ensure their subcontractors comply with this program. Nothing in this section shall be interpreted to hold a prime contractor liable for any discriminatory practice of its subcontractors.

The Contractor shall include the foregoing clause in all contracts between the Contractor and Subcontractors and Suppliers.

2. If the Contract is competitively solicited, the selected Bidder shall submit a Work Force Report (Form BB05), within 10 Working Days after receipt by the Bidder of Contract forms to the City for approval as specified in the Notice of Intent to Award letter from the City.
3. If a Work Force Report is submitted, and the City determines there are under-representations when compared to County Labor Force Availability data, the selected Bidder shall submit an Equal Employment Opportunity Plan.
4. If the selected Bidder submits an Equal Employment Opportunity Plan, it shall include the following assurances:
 1. The Contractor shall maintain a working environment free of discrimination, harassment, intimidation and coercion at all sites and in all facilities at which the Contractor's employees are assigned to work.
 2. The Contractor reviews its EEO Policy, at least annually, with all on-site supervisors involved in employment decisions.
 3. The Contractor disseminates and reviews its EEO Policy with all employees at least once a year, posts the policy statement and EEO posters on all company bulletin boards and job sites, and documents every dissemination, review and posting with a written record to identify the time, place, employees present, subject matter, and disposition of meetings.
 4. The Contractor reviews, at least annually, all supervisors' adherence to and performance under the EEO Policy and maintains written documentation of these reviews.
 5. The Contractor discusses its EEO Policy Statement with subcontractors with whom it anticipates doing business, includes the EEO Policy Statement in its subcontracts, and provides such documentation to the City upon request.

6. The Contractor documents and maintains a record of all bid solicitations and outreach efforts to and from subcontractors, contractor associations and other business associations.
7. The Contractor disseminates its EEO Policy externally through various media, including the media of people of color and women, in advertisements to recruit, maintains files documenting these efforts, and provides copies of these advertisements to the City upon request.
8. The Contractor disseminates its EEO Policy to union and community organizations.
9. The Contractor provides immediate written notification to the City when any union referral process has impeded the Contractor's efforts to maintain its EEO Policy.
10. The Contractor maintains a current list of recruitment sources, including those outreaching to people of color and women, and provides written notification of employment opportunities to these recruitment sources with a record of the organizations' responses.
11. The Contractor maintains a current file of names, addresses and phone numbers of each walk-in applicant, including people of color and women, and referrals from unions, recruitment sources, or community organizations with a description of the employment action taken.
12. The Contractor encourages all present employees, including people of color and women employees, to recruit others.
13. The Contractor maintains all employment selection process information with records of all tests and other selection criteria.
14. The Contractor develops and maintains documentation for on-the-job training opportunities, participates in training programs, or both for all of its employees, including people of color and women, and establishes apprenticeship, trainee, and upgrade programs relevant to the Contractor's employment needs.
15. The Contractor conducts, at least annually, an inventory and evaluation of all employees for promotional opportunities and encourages all employees to seek and prepare appropriately for such opportunities.
16. The Contractor ensures the company's working environment and activities are non-segregated except for providing separate or single-user toilets and necessary changing facilities to assure privacy between the sexes.

ATTACHMENT D

INTENTIONALLY LEFT BLANK

ATTACHMENT E

SUPPLEMENTARY SPECIAL PROVISIONS

SUPPLEMENTARY SPECIAL PROVISIONS

The following Supplementary Special Provisions (SSP) modifies the following documents:

- 1) Standard Specifications for Public Works Construction (The GREENBOOK) currently in effect.
 - 2) The City of San Diego Standard Specifications for Public Works Construction (The WHITEBOOK).
-

SECTION 1 – TERMS, DEFINITIONS, ABBREVIATIONS, UNITS OF MEASURE, AND SYMBOLS

1-2 TERMS AND DEFINITIONS.

Normal Working Hours. To the City Supplement, ADD the following:

The Normal Working Hours are 8:30 AM to 3:30 PM.

SECTION 2 - SCOPE AND CONTROL OF WORK

2-3.2 Self Performance. DELETE in its entirety and SUBSTITUTE with the following:

1. You must perform, with your own organization, Contract work amounting to at least 50% of the base bid alone or base bid and any additive or deductive alternate(s) that together when added or deducted form the basis of award.
2. The self performance percentage requirement will be waived for contracts when a “B” License is required or allowed.

2-5.3.1 General. To the City Supplement, ADD the following

7. For products for which an AML is available, products listed in the AML shall be used. A submittal review will be conducted for products not identified on an AML on a case-by-case basis when:
 - a) The product type or category is not in the AML.
 - b) The AML does not list at least two available manufacturers of the product.
 - c) The material or manufacturer listed in the AML is no longer available. Documentation to substantiate the product is no longer available or in production is required as part of the submittal.

In the case of conducting a submittal review when required by the Plans or Special Provisions, or when requested by the Engineer, all submittals shall be accompanied by the City's submittal form.

The Product Submittal Form is available for download at:

<http://www.sandiego.gov/publicworks/edocref/index.shtml>

2-9.2 Survey Service. DELETE in its entirety and SUBSTITUTE with the following:

The Contractor shall be responsible for all surveying services or as may be specified in these special provisions.

The payment for survey services shall be included in the various Bid items unless a Bid item for Survey Service has been provided.

SECTION 4 - CONTROL OF MATERIALS

4-1.3.6 Preapproved Materials. To the City Supplement, ADD the following:

3. You shall submit in writing a list of all products to be incorporated in the Work that are on the AML.

ADD:

4-1.3.7 Testing under the direction of the Engineer. When a bid item for Testing under the direction of the Engineer is provided, the Contractor must employ and pay for the services of a qualified third party independent laboratory to perform the required testing. The Contractor will be reimbursed for the cost of testing under this bid item.

4-1.6 Trade Names or Equals. ADD the following:

You must submit your list of proposed substitutions for "an equal" ("or equal") item(s) **no later than 5 Working Days after the determination of the Apparent Low Bidder** and on the City's Product Submittal Form available at:

<http://www.sandiego.gov/publicworks/edocref/index.shtml>

SECTION 7 - RESPONSIBILITIES OF THE CONTRACTOR

7-3 LIABILITY INSURANCE. DELETE in its entirety and SUBSTITUTE with the following:

The insurance provisions herein must not be construed to limit your indemnity obligations contained in the Contract.

7-3.1 Policies and Procedures.

1. You must procure the insurance described below, at its sole cost and expense, to provide coverage against claims for loss including injuries to

persons or damage to property, which may arise out of or in connection with the performance of the Work by you, your agents, representatives, officers, employees or Subcontractors.

2. Insurance coverage for property damage resulting from your operations is on a replacement cost valuation. The market value will not be accepted.
3. You must maintain this insurance for the duration of this contract and at all times thereafter when you are correcting, removing, or replacing Work in accordance with this contract. Your liabilities under the Contract, e.g., your indemnity obligations, is not deemed limited to the insurance coverage required by this contract.
4. Payment for insurance is included in the various items of Work as bid by you, and except as specifically agreed to by the City in writing, you are not entitled to any additional payment. Do not begin any work under this contract until you have provided and the City has approved all required insurance.
5. Policies of insurance must provide that the City is entitled to 30 days (10 days for cancellation due to non-payment of premium) prior written notice of cancellation or non-renewal of the policy. Maintenance of specified insurance coverage is a material element of the Contract. Your failure to maintain or renew coverage or to provide evidence of renewal during the term of the Contract may be treated by the City as a material breach of the Contract.

7-3.2 Types of Insurance.

7-3.2.1 Commercial General Liability Insurance.

1. Commercial General Liability Insurance must be written on the current version of the ISO Occurrence form CG 00 01 07 98 or an equivalent form providing coverage at least as broad.
2. The policy must cover liability arising from premises and operations, XCU (explosions, underground, and collapse), independent contractors, products/completed operations, personal injury and advertising injury, bodily injury, property damage, and liability assumed under an insured’s contract (including the tort liability of another assumed in a business contract).
3. There must be no endorsement or modification limiting the scope of coverage for either “insured vs. insured” claims or contractual liability. You must maintain the same or equivalent insurance for at least 10 years following completion of the Work.
4. All costs of defense must be outside the policy limits. Policy coverage must be in liability limits of not less than the following:

<u>General Annual Aggregate Limit</u>	<u>Limits of Liability</u>
Other than Products/Completed Operations	\$2,000,000
Products/Completed Operations Aggregate Limit	\$2,000,000

Personal Injury Limit	\$1,000,000
Each Occurrence	\$1,000,000

7-3.2.2 Commercial Automobile Liability Insurance.

1. You must provide a policy or policies of Commercial Automobile Liability Insurance written on the current version of the ISO form CA 00 01 12 90 or later version or equivalent form providing coverage at least as broad in the amount of \$1,000,000 combined single limit per accident, covering bodily injury and property damage for owned, non-owned, and hired automobiles (“Any Auto”).
2. All costs of defense must be outside the limits of the policy.

7-3.3 Rating Requirements. Except for the State Compensation Insurance Fund, all insurance required by this contract as described herein must be carried only by responsible insurance companies with a rating of, or equivalent to, at least “A-, VI” by A.M. Best Company, that are authorized by the California Insurance Commissioner to do business in the State, and that have been approved by the City.

7-3.3.1 Non-Admitted Carriers. The City will accept insurance provided by non-admitted, “surplus lines” carriers only if the carrier is authorized to do business in the State and is included on the List of Approved Surplus Lines Insurers (LASLI list).

All policies of insurance carried by non-admitted carriers must be subject to all of the requirements for policies of insurance provided by admitted carriers described herein.

7-3.4 Evidence of Insurance. Furnish to the City documents e.g., certificates of insurance and endorsements evidencing the insurance required herein, and furnish renewal documentation prior to expiration of this insurance. Each required document must be signed by the insurer or a person authorized by the insurer to bind coverage on its behalf. We reserve the right to require complete, certified copies of all insurance policies required herein.

7-3.5 Policy Endorsements.

7-3.5.1 Commercial General Liability Insurance.

7-3.5.1.1 Additional Insured.

- a) You must provide at your expense policy endorsement written on the current version of the ISO Occurrence form CG 20 10 11 85 or an equivalent form providing coverage at least as broad.
- b) To the fullest extent allowed by law e.g., California Insurance Code §11580.04, the policy must be endorsed to include the City and its respective elected officials, officers, employees, agents, and representatives as additional insured.
- c) The additional insured coverage for projects for which the Engineer’s Estimate is \$1,000,000 or more must include liability arising out of: (a) Ongoing operations performed by you or on your behalf, (b) your products,

(c) your work, e.g., your completed operations performed by you or on your behalf, or (d) premises owned, leased, controlled, or used by you.

d) The additional insured coverage for projects for which the Engineer's Estimate is less than \$1,000,000 must include liability arising out of: (a) Ongoing operations performed by you or on your behalf, (b) your products, or (c) premises owned, leased, controlled, or used by you.

7-3.5.1.2 Primary and Non-Contributory Coverage. The policy must be endorsed to provide that the coverage with respect to operations, including the completed operations, if appropriate, of the Named Insured is primary to any insurance or self-insurance of the City and its elected officials, officers, employees, agents and representatives. Further, it must provide that any insurance maintained by the City and its elected officials, officers, employees, agents and representatives must be in excess of your insurance and must not contribute to it.

7-3.5.1.3 Project General Aggregate Limit. The policy or policies must be endorsed to provide a Designated Construction Project General Aggregate Limit that will apply only to the Work. Only claims payments which arise from the Work must reduce the Designated Construction Project General Aggregate Limit. The Designated Construction Project General Aggregate Limit must be in addition to the aggregate limit provided for the products-completed operations hazard.

7-3.5.2 Commercial Automobile Liability Insurance.

7-3.5.2.1 Additional Insured. Unless the policy or policies of Commercial Auto Liability Insurance are written on an ISO form CA 00 01 12 90 or a later version of this form or equivalent form providing coverage at least as broad, the policy must be endorsed to include the City and its respective elected officials, officers, employees, agents, and representatives as additional insured, with respect to liability arising out of automobiles owned, leased, hired or borrowed by you or on your behalf. This endorsement is limited to the obligations permitted by California Insurance Code §11580.04.

7-3.6 Deductibles and Self-Insured Retentions. You must pay for all deductibles and self-insured retentions. You must disclose deductibles and self-insured retentions to the City at the time the evidence of insurance is provided.

7-3.7 Reservation of Rights. The City reserves the right, from time to time, to review your insurance coverage, limits, deductibles and self-insured retentions to determine if they are acceptable to the City. The City will reimburse you, without overhead, profit, or any other markup, for the cost of additional premium for any coverage requested by the Engineer but not required by this contract.

7-3.8 Notice of Changes to Insurance. You must notify the City 30 days prior to any material change to the policies of insurance provided under this contract.

7-3.9 Excess Insurance. Policies providing excess coverage must follow the form of the primary policy or policies e.g., all endorsements.

7-4 WORKERS' COMPENSATION INSURANCE. DELETE in its entirety and SUBSTITUTE with the following:

7-4.1 Workers' Compensation Insurance and Employers Liability Insurance.

1. In accordance with the provisions of §3700 of the California Labor Code, you must provide at your expense Workers' Compensation Insurance and Employers Liability Insurance to protect you against all claims under applicable state workers compensation laws. The City, its elected officials, and employees will not be responsible for any claims in law or equity occasioned by your failure to comply with the requirements of this section.
2. Limits for this insurance must be not less than the following:

<u>Workers' Compensation</u>	<u>Statutory Employers Liability</u>
Bodily Injury by Accident	\$1,000,000 each accident
Bodily Injury by Disease	\$1,000,000 each employee
Bodily Injury by Disease	\$1,000,000 policy limit

3. By signing and returning the Contract you certify that you are aware of the provisions of §3700 of the Labor Code which require every employer to be insured against liability for worker's compensation or to undertake self-insurance in accordance with the provisions of that code and you must comply with such provisions before commencing the Work as required by §1861 of the California Labor Code.

7-4.1.1 Waiver of Subrogation. The policy or policies must be endorsed to provide that the insurer will waive all rights of subrogation against the City, and its respective elected officials, officers, employees, agents, and representatives for losses paid under the terms of the policy or policies and which arise from work performed by the Named Insured for the City.

7-10.5.3 Steel Plate Covers. Table 7-10.5.3(A), REVISE the plate thickness for 5'-3" trench width to read 1 3/4".

7-15 INDEMNIFICATION AND HOLD HARMLESS AGREEMENT. To the City Supplement, fourth paragraph, last sentence, DELETE in its entirety and SUBSTITUTE with the following:

Your duty to indemnify and hold harmless does not include any claims or liability arising from the established active or sole negligence, or willful misconduct of the City, its officers, or employees.

7-16 COMMUNITY LIASON. To the City Supplement, DELETE in its entirety and SUSBTITUTE with the following:

ADD:

7-16 COMMUNITY OUTREACH.

7-16.1 General.

1. To ensure consistency with the City's community outreach plan for the project, the City will work with the Contractor to inform the public (which includes, but is not limited to, property owners, renters, homeowners, business owners, recreational users, and other community members and stakeholders) of construction impacts. Efforts by the Contractor to mitigate construction impacts by communicating with the public require close coordination and cooperation with the City.
2. The Contractor will perform the community outreach activities required throughout the Contract Time.
3. The Contractor shall closely coordinate the Work with the businesses, institutions, residents and property owners impacted by the Project. Example duties of the Contractor include notification to the businesses, institutions and residents of the commencement of construction activities not less than 5 days in advance, coordination of access for vehicular and pedestrian traffic to businesses, institutions and residences impacted by the Project, reporting of Contractor activities at all Project progress meetings scheduled by the Engineer, attendance to the Project Pre-construction Meeting, attendance at 2 community meetings, response to community questions and complaints related to Contractor activities, and written documentation including logging in all inquiries and complaints received into the City's Public Contact Log located on the City's SDSShare site:

<http://sdshare/forums/ecp/PITS/picr/Lists/Public%20Contact%20Log/AllItems.aspx>

4. The Contractor shall execute the Information Security Policy Acknowledgement Form - For Non-City Employees within 15 days of the award of the Contract if:
 - a) The contact information for the Contractor is made available on any outreach materials or;
 - b) The Contractor will be the primary point of contact to resolve project related inquiries and complaints.
5. Electronic Communication.

All inquiries and complaints will be logged in to the City's SDSShare site within 24 hours of receipt of inquiries and complaints.

Any updates or a resolution of inquiries, and complaints shall be documented in the City's SDSShare site within 24 hours.

Copies of email communications shall be saved on to the City's SDSShare site as individually as an Outlook Message Format (*.msg).

All graphics, photos, and other electronic files associated with the inquiries and or complaints shall be saved into the individual record.

6. **When specified**, present your Exclusive Community Liaison to the Engineer, in writing, within 15 days of the award of the Contract.

7-16.2 Submittals.

1. The Contractor shall submit to the Resident Engineer, for review and approval, all drafts of letters, notices, postcards, door hangers, signs, mailing lists, proposed addresses for hand-delivery, and any other notices and letters that are to be mailed and or distributed to the public.
 - a. Prior to distributing or mailing, the Contractor shall submit final drafts of letters, notices, postcards, door hangers, signs, and any other notices and letters to the Resident Engineer for final review and approval.
 - b. After distributing or mailing, the Contractor shall submit verification of delivery and any copies of returned notices to the Resident Engineer.
2. The Contractor will use the City's SDShare site to identify and summarize communications (via phone, in person, and email) with the public the within 24 hours of receipt, even if the Contractor's response to the individual is still incomplete. The Contractor will upload to the City's SDShare site copies of all written, electronic, and verbal communications and conversations with the public.

7-16.3 Public Notice by Contractor.

1. Furnish and distribute public notices in the form of door hangers using the City's format to all occupants and/or property owners along streets where Work is to be performed at least 5 days before starting the Work as directed by the Resident Engineer.
2. For all Work on private property, contact each owner and occupant individually a minimum of 15 days prior to the Work. If the Work has been delayed, re-notify owners and occupants of the new Work schedule, as directed by the Resident Engineer.

7-16.4 Quality Assurance.

1. During the course of community outreach, the Contractor shall ensure the character of all persons that conduct community outreach (distributing door hangers, attending community meetings, interacting with the public, etc.), on behalf of the Contractor:
 - a. Have the ability to speak and comprehend English and/or Spanish, as appropriate for the community or public they are informing,
 - b. Possess and display easily verifiable and readable personal identification that identifies the person as an employee of the Contractor,
 - c. Have the interpersonal skills to effectively, professionally, and tactfully represent the project, Contractor, and City to the public.

7-16.5 Communications with the Public.

1. The Contractor shall provide updates on construction impacts to the Resident Engineer. The Contractor shall notify the Resident Engineer in advance about time-sensitive construction impacts and may be required to distribute construction impact notices to the public on short notice.
2. The Contractor shall incorporate community outreach activities related to construction impacts in the baseline schedule and update the Resident Engineer with each week's submittal of the Three-Week Look Ahead Schedule.
3. At the request of the Resident Engineer, the Contractor shall attend and participate in project briefings at community meetings.
4. The Contractor shall coordinate with the Resident Engineer on all responses and actions taken to address public inquiries and complaints within 24-hours that they are received.

7-16.6 Communications with Media.

1. The City may allow members of the media access to its construction site(s) on a case-by-case basis only.
2. Occasionally, members of the media may show up at construction sites, uninvited. Members of the media (including, but not limited to newspaper, magazine, radio, television, bloggers, and videographers) do not have the legal right to be in the construction site without the City's permission.
3. In the event media representatives arrive near or on the construction site(s), the Contractor shall keep them off the site(s), in a courteous and professional manner, until a Public Information Officer is available to meet them at an approved location.
4. The Contractor shall report all members of the media visits to the Resident Engineer as quickly as possible, so that the City's Public Information Officer can meet with the members of the media at the construction site(s).
5. If the City allows members of the media to access a construction site, the Contractor shall allow the City to escort the media representatives while they are on the construction site and shall ensure their safety.
6. The Contractor shall require media representatives to sign in and out of the Site Visitor Log and to use Personal Protective Equipment.
7. The Contractor has a right to speak to members of the media about its company and its role on the project. All other questions shall be referred to the City.

7-16.7 Exclusive Community Liaison Services.

If directed to conduct Exclusive Community Liaison Services, the Contractor shall retain an Exclusive Community Liaison for the Project whose sole responsibilities will be as follows:

1. Develop a contact list of community, tenants, property owners, and agencies with a stake in the project.
2. Notify businesses, institutions, property owners, and residents of the commencement of construction activities and utility service interruptions not less than 5 days in advance.
3. Coordinate access for vehicular and pedestrian traffic to businesses, institutions and residences impacted by the Project.
4. Prepare and present of materials in coordination with the Resident Engineer (the City's standards and guidelines for the communication materials are available for review by Bidders by sending a request to the Contract Specialist).
5. Respond to community questions and complaints related to Contractor activities.
6. Write, edit, update, or produce brochures, pamphlets and news releases.
7. Provide standard telephone inquiries and e-mail responses:
 - a) Respond to telephone calls and e-mails from the public.
 - b) Record calls and e-mails on the City's SDSshare site.
8. Report Exclusive Community Liaison activities at all progress meetings scheduled by the Resident Engineer.
9. Attendance at pre-construction, community and stakeholders meetings.

7-16.7.1 Exclusive Community Liaison Work Plan. The Work plan for the Exclusive Community Liaison shall address the items of Work specified in these specifications. Present your Exclusive Community Liaison and submit your exclusive community outreach plan (in writing) as **specified** within 15 days of the Award of the Contract.

7-16.8 Payment. The Payment for the community outreach and public notices is included in the various Bid items. The payment for exclusive community liaison is in the bid item for "Exclusive Community Liaison Services" when provided as a separate Bid item." If no Bid item has been provided the payment is included in the various Bid items.

7-20 ELECTRONIC COMMUNICATION. ADD the following:

Virtual Project Manager will be used on this contract.

SECTION 8 - FACILITIES FOR AGENCY PERSONNEL

8-2 FIELD OFFICE FACILITIES. To the City Supplement, DELETE in its entirety.

SECTION 9 - MEASUREMENT AND PAYMENT

9-3.2.5 Withholding of Payment. To the City Supplement, item i), DELETE in its entirety and SUBSTITUTE with the following:

- i) Your failure to comply with 7-2.3, "PAYROLL RECORDS" and 2-16, "CONTRACTOR REGISTRATION AND ELECTRONIC REPORTING SYSTEM."

ADD:

9-3.7 Compensation Adjustments for Price Index Fluctuations. This Contract is not subject to the provisions of The WHITEBOOK for Compensation Adjustments for Price Index Fluctuations for the paving asphalt.

SECTION 203 – BITUMINOUS MATERIALS

203-15 RUBBER POLYMER MODIFIED SLURRY (RPMS). To the City Supplement, CORRECT section numbering as follows:

OLD SECTION NUMBER	TITLE	NEW SECTION NUMBER
203-15	RUBBER POLYMER MODIFIED SLURRY (RPMS)	203-16
203-15.1	General	203-16.1
203-15.2	Materials	203-16.2
203-15.3	Composition and Grading	203-16.3
203-15.4	Mix Design	203-16.4

ADD the following:

RPMS shall be used on this contract.

SECTION 209 – STREET LIGHTING AND TRAFFIC SIGNAL MATERIALS

209-6.4 Induction Cobra Head Luminaire. To the City Supplement, CORRECT certain section numbering as follows:

OLD SECTION NUMBER	TITLE	NEW SECTION NUMBER
209-6.4.7	Luminaire Identification	209-6.4.8
209-6.4.8	Photometric Documentation	209-6.4.9
209-6.4.9	Quality Assurance	209-6.4.10

SECTION 300 - EARTHWORK

300-1.4 Payment. To the City Supplement, paragraph (2), DELETE in its entirety and SUBSTITUTE with the following:

2. Payment for existing pavement removal and disposal of up to 12” thick, within the excavation e.g., trench limits, shall be included in the Bid item for installation of the mains or the Work item that requires pavement removal.

SECTION 302 - ROADWAY SURFACING

302-3 PREPARATORY REPAIR WORK. To the City Supplement, DELETE in its entirety and SUBSTITUTE with the following:

302-3 PREPARATORY REPAIR WORK.

1. Prior to roadway resurfacing or the application of slurry, the Contractor shall complete all necessary preparation and repair work to the road segment e.g., tree trimming, weed spray, weed abatement, crack sealing, asphalt repair, hump removal, miscellaneous asphalt patching, removal of raised pavement markers, removal of pavement markings, etc. and as specified in the Special Provisions.
2. Preparatory work shall include, but not be limited to, tree trimming, weed spray, weed abatement, crack sealing, asphalt repair i.e., mill and pave, hump removal, miscellaneous asphalt patching, removal of raised pavement markers, removal of pavement markings, etc.
3. The Contractor shall repair areas of distressed asphalt concrete pavement by milling or removing damaged areas of pavement to a minimum depth of 2” for Residential streets, and a minimum depth of 3” for all others to expose firm and unyielding pavement. The Contractor shall prepare subgrade as needed and install a minimum of 2” for residential streets, and a minimum of 3” for all others, of compacted asphalt concrete pavement over compacted native material as directed by the Engineer.
4. If, in order to achieve the minimum specified depth, the base material is exposed, the material shall be compacted to 95% relative compaction to a depth 10” below the finished grade (dig out). Compaction tests shall be made to ensure compliance with the specifications. The Engineer will determine when and where the test will occur. The City will pay for the soils testing required by the Engineer, which meets the required compaction. The Contractor shall reimburse the City for the cost of retesting failing compaction tests. If additional base material is required, the Contractor shall use Class 2 Aggregate Base in accordance with 200-2.2, “Crushed Aggregate Base.”

5. Recycled base material shall conform to Crushed Miscellaneous Base Material in accordance with 200-2.4, "Crushed Miscellaneous Aggregate Base."
6. Prior to replacing asphalt, the area shall be cleaned by removing all loose and damaged material, moisture, dirt, and other foreign matter and shall be tack coated in accordance with 302-5.4 "Tack Coat."
7. The Contractor shall install new asphalt within the repair area or for patches in accordance with 302-5, "ASPHALT CONCRETE PAVEMENT." Asphalt concrete shall be C2-PG 64-10 in compliance with 400-4, "ASPHALT CONCRETE."
8. No preparatory asphalt work shall be done when the atmospheric temperature is below 50 °F or during unsuitable weather.
9. Following the asphalt placement, the Contractor shall roll the entire area of new asphalt in both directions at least twice. The finished patch shall be level and smooth in compliance with 302-5.6.2 "Density and Smoothness." After placement and compaction of the asphalt patch, the Contractor shall seal all finished edges with a 4" wide continuous band of SS-1H.
10. The minimum dimension for each individual repair shall be 4' x 4' and shall be subject to the following conditions:
 - a) If the base material is exposed to achieve the required minimum removal thickness, the base material shall be prepared conforming to 301-1, "SUBGRADE PREPARATION."
 - b) When additional base material is required, then the contractor shall use Class 2 Aggregate Base in accordance with 200-2.2, "Crushed Aggregate Base." Recycled base material shall conform to Crushed Miscellaneous Base Material in accordance with 200-2.4, "Crushed Miscellaneous Base."
 - c) The Contractor may use grinding as a method for removal of deteriorated pavement when the areas indicated for removal are large enough (a minimum of the machine drum width) and when approved by the Engineer.
 - d) For both scheduled and unscheduled base repairs, failed areas may be removed by milling or by excavation provided that the edges are cut cleanly with a saw. The areas shall be cleaned and tack coated in accordance with 302-5.4, "Tack Coat" before replacing the asphalt. The areas for scheduled repairs have been marked on the street.

302-3.1 Asphalt Patching.

1. Asphalt patching shall consist of patching potholes, gutter-line erosion, and other low spots in the pavement that are deeper than ½" per 302-5.6.2,

“Density and Smoothness.” These areas are generally smaller and more isolated than those areas in need of mill and pave.

2. The areas requiring patching have been identified in the Contract Documents, marked on the streets, or as directed by the Engineer. The Contractor shall identify any new areas that may require patching prior to slurry work to ensure the smoothness and quality of the finished product.
3. The Contractor shall identify and repair any areas that may require patching, prior to the placement of slurry seal for smooth finished product.
4. Asphalt overlay shall not be applied over deteriorated pavement. Preparatory asphalt work shall be completed and approved by the Engineer before proceeding with asphalt overlay.
5. The Contractor shall remove distressed asphalt pavement either by saw cutting or milling, to expose firm and unyielding pavement; prepare subgrade (as needed); and install compacted asphalt concrete pavement over compacted native material as directed by the Engineer.
6. Prior to replacing asphalt, the area shall be cleaned and tack coated per 302-5.4, “Tack Coat”.
7. Following the asphalt placement, the Contractor shall roll the entire patch in both directions covering the patch at least twice.
8. After placement and compaction of the asphalt patch, the Contractor shall seal all finished edges with a 4” wide continuous band of SS-1H.
9. Base repairs shall not exceed 20% RAP in content.

302-3.2 Payment.

1. Payment for replacement of existing pavement when required shall be included in the unit bid price for Asphalt Pavement repair for the total area replaced and no additional payment shall be made regardless of the number of replacements completed. No payment shall be made for areas of over excavation or outside trench areas in utility works unless previously approved by the Engineer. No payment for pavement replacement will be made when the damage is due to the Contractor’s failure to protect existing improvements. The Contractor shall reimburse the City for the cost of retesting all failing compaction tests.
2. The areas and quantities shown on the road segments and in appendices are given only for the Contractor’s aid in planning the Work and preparing Bids. The Engineer will designate the limits to be removed and these designated areas shall be considered to take precedent over the area shown in an Appendix to the Contract Documents. The quantities shown in the appendices are based on a street assessment survey and may vary.

3. At the end of each day, the Contractor shall submit to the Engineer an itemized list of the asphalt pavement repair work completed. The list shall include the location of the work and the exact square footage of the repair.
4. Preparatory repair work and tack coating will be paid at the Contract unit price per ton for Asphalt Pavement Repair. No payment shall be made for areas of over excavation unless previously approved by the Engineer.
5. Milling shall be included in the Bid item for Asphalt Pavement Repair unless separate Bid item has been provided.
6. Payment for miscellaneous asphalt patching shall be included in the Contract unit price for slurry and no additional payment shall be made therefore.

302-5.1.1 Damaged AC Pavement Replacement. To the City Supplement, DELETE in its entirety.

302-5.1.2 Measurement and Payment. To the City Supplement, DELETE in its entirety.

302-5.2.1 Measurement and Payment. To the City Supplement, item c), ADD the following:
Imported Subgrade material shall be paid per bid item "Imported Backfill".

302-6.8 Measurement and Payment. ADD the following:

Concrete pavement shall include removal of existing AC pavement, extension of median and shall be paid as shown on the bid.

SECTION 303 - CONCRETE AND MASONRY CONSTRUCTION

303-5.9 Measurement and Payment. To the City Supplement, paragraph (6), DELETE in its entirety and SUBSTITUTE with the following:

6. Measurement shall be made of actual areas authorized by the Engineer, calculated as square feet in place. Excavation, removal of existing sidewalk, grading, and backfilling shall be included in the unit price bid for sidewalk, curb ramps or curb and gutter respectively.

SECTION 701 – WATER POLLUTION CONTROL

701-11 POST CONSTRUCTION REQUIREMENTS. To the City Supplement, second paragraph, ADD the following:

Comply with the following post construction requirements:

Inlet Markers.

SECTION 707 – RESOURCE DISCOVERIES

ADD:

707-1.1

Environmental Document. The City of San Diego Environmental Analysis Section (EAS) of the Development Services Department has prepared a Notice of Exemption for Solola and Euclid Curb Ramps Installation, as referenced in the Contract Appendix. You must comply with all requirements of the Notice of Exemption as set forth in the Contract Appendix A.

Compliance with the City’s environmental document is included in the various Bid items, unless a bid item has been provided.

END OF SUPPLEMENTARY SPECIAL PROVISIONS (SSP)

SUPPLEMENTARY SPECIAL PROVISIONS

APPENDICES

APPENDIX A
NOTICE OF EXEMPTION

APPENDIX B
FIRE HYDRANT METER PROGRAM

CITY OF SAN DIEGO CALIFORNIA DEPARTMENT INSTRUCTIONS	NUMBER DI 55.27	DEPARTMENT Water Department
SUBJECT FIRE HYDRANT METER PROGRAM (FORMERLY: CONSTRUCTION METER PROGRAM)	PAGE 1 OF 10	EFFECTIVE DATE October 15, 2002
	SUPERSEDES DI 55.27	DATED April 21, 2000

1. **PURPOSE**

- 1.1 To establish a Departmental policy and procedure for issuance, proper usage and charges for fire hydrant meters.

2. **AUTHORITY**

- 2.1 All authorities and references shall be current versions and revisions.
- 2.2 San Diego Municipal Code (NC) Chapter VI, Article 7, Sections 67.14 and 67.15
- 2.3 Code of Federal Regulations, Safe Drinking Water Act of 1986
- 2.4 California Code of Regulations, Titles 17 and 22
- 2.5 California State Penal Code, Section 498B.0
- 2.6 State of California Water Code, Section 110, 500-6, and 520-23
- 2.7 Water Department Director

Reference

- 2.8 State of California Guidance Manual for Cross Connection Programs
- 2.9 American Water Works Association Manual M-14, Recommended Practice for Backflow Prevention
- 2.10 American Water Works Association Standards for Water Meters
- 2.11 U.S.C. Foundation for Cross Connection Control and Hydraulic Research Manual

3. **DEFINITIONS**

- 3.1 **Fire Hydrant Meter:** A portable water meter which is connected to a fire hydrant for the purpose of temporary use. (These meters are sometimes referred to as Construction Meters.)

CITY OF SAN DIEGO CALIFORNIA DEPARTMENT INSTRUCTIONS	NUMBER DI 55.27	DEPARTMENT Water Department
SUBJECT FIRE HYDRANT METER PROGRAM (FORMERLY: CONSTRUCTION METER PROGRAM)	PAGE 2 OF 10	EFFECTIVE DATE October 15, 2002
	SUPERSEDES DI 55.27	DATED April 21, 2000

- 3.2 **Temporary Water Use:** Water provided to the customer for no longer than twelve (12) months.
- 3.3 **Backflow Preventor:** A Reduced Pressure Principal Assembly connected to the outlet side of a Fire Hydrant Meter.

4. **POLICY**

- 4.1 The Water Department shall collect a deposit from every customer requiring a fire hydrant meter and appurtenances prior to providing the meter and appurtenances (see Section 7.1 regarding the Fees and Deposit Schedule). The deposit is refundable upon the termination of use and return of equipment and appurtenances in good working condition.
- 4.2 Fire hydrant meters will have a 2 ½" swivel connection between the meter and fire hydrant. The meter shall not be connected to the 4" port on the hydrant. All Fire Hydrant Meters issued shall have a Reduced Pressure Principle Assembly (RP) as part of the installation. Spanner wrenches are the only tool allowed to turn on water at the fire hydrant.
- 4.3 The use of private hydrant meters on City hydrants is prohibited, with exceptions as noted below. All private fire hydrant meters are to be phased out of the City of San Diego. All customers who wish to continue to use their own fire hydrant meters must adhere to the following conditions:
 - a. Meters shall meet all City specifications and American Water Works Association (AWWA) standards.
 - b. Customers currently using private fire hydrant meters in the City of San Diego water system will be allowed to continue using the meter under the following conditions:
 - 1. The customer must submit a current certificate of accuracy and calibration results for private meters and private backflows annually to the City of San Diego, Water Department, Meter Shop.

CITY OF SAN DIEGO CALIFORNIA DEPARTMENT INSTRUCTIONS	NUMBER DI 55.27	DEPARTMENT Water Department
SUBJECT FIRE HYDRANT METER PROGRAM (FORMERLY: CONSTRUCTION METER PROGRAM)	PAGE 3 OF 10	EFFECTIVE DATE October 15, 2002
	SUPERSEDES DI 55.27	DATED April 21, 2000

2. The meter must be properly identifiable with a clearly labeled serial number on the body of the fire hydrant meter. The serial number shall be plainly stamped on the register lid and the main casing. Serial numbers shall be visible from the top of the meter casing and the numbers shall be stamped on the top of the inlet casing flange.
3. All meters shall be locked to the fire hydrant by the Water Department, Meter Section (see Section 4.7).
4. All meters shall be read by the Water Department, Meter Section (see Section 4.7).
5. All meters shall be relocated by the Water Department, Meter Section (see Section 4.7).
6. These meters shall be tested on the anniversary of the original test date and proof of testing will be submitted to the Water Department, Meter Shop, on a yearly basis. If not tested, the meter will not be allowed for use in the City of San Diego.
7. All private fire hydrant meters shall have backflow devices attached when installed.
8. The customer must maintain and repair their own private meters and private backflows.
9. The customer must provide current test and calibration results to the Water Department, Meter Shop after any repairs.
10. When private meters are damaged beyond repair, these private meters will be replaced by City owned fire hydrant meters.

CITY OF SAN DIEGO CALIFORNIA DEPARTMENT INSTRUCTIONS	NUMBER DI 55.27	DEPARTMENT Water Department
SUBJECT FIRE HYDRANT METER PROGRAM (FORMERLY: CONSTRUCTION METER PROGRAM)	PAGE 4 OF 10	EFFECTIVE DATE October 15, 2002
	SUPERSEDES DI 55.27	DATED April 21, 2000

11. When a private meter malfunctions, the customer will be notified and the meter will be removed by the City and returned to the customer for repairs. Testing and calibration results shall be given to the City prior to any re-installation.
 12. The register shall be hermetically sealed straight reading and shall be readable from the inlet side. Registration shall be in hundred cubic feet.
 13. The outlet shall have a 2 ½ “National Standards Tested (NST) fire hydrant male coupling.
 14. Private fire hydrant meters shall not be transferable from one contracting company to another (i.e. if a company goes out of business or is bought out by another company).
- 4.4 All fire hydrant meters and appurtenances shall be installed, relocated and removed by the City of San Diego, Water Department. All City owned fire hydrant meters and appurtenances shall be maintained by the City of San Diego, Water Department, Meter Services.
- 4.5 If any fire hydrant meter is used in violation of this Department Instruction, the violation will be reported to the Code Compliance Section for investigation and appropriate action. Any customer using a fire hydrant meter in violation of the requirements set forth above is subject to fines or penalties pursuant to the Municipal Code, Section 67.15 and Section 67.37.
- 4.6 **Conditions and Processes for Issuance of a Fire Hydrant Meter**
- Process for Issuance
- a. Fire hydrant meters shall only be used for the following purposes:
 1. Temporary irrigation purposes not to exceed one year.

CITY OF SAN DIEGO CALIFORNIA DEPARTMENT INSTRUCTIONS	NUMBER DI 55.27	DEPARTMENT Water Department
SUBJECT FIRE HYDRANT METER PROGRAM (FORMERLY: CONSTRUCTION METER PROGRAM)	PAGE 5 OF 10	EFFECTIVE DATE October 15, 2002
	SUPERSEDES DI 55.27	DATED April 21, 2000

2. Construction and maintenance related activities (see Tab 2).
 - b. No customer inside or outside the boundaries of the City of San Diego Water Department shall resell any portion of the water delivered through a fire hydrant by the City of San Diego Water Department.
 - c. The City of San Diego allows for the issuance of a temporary fire hydrant meter for a period not to exceed 12 months (365 days). An extension can only be granted in writing from the Water Department Director for up to 90 additional days. A written request for an extension by the consumer must be submitted at least 30 days prior to the 12 month period ending. No extension shall be granted to any customer with a delinquent account with the Water Department. No further extensions shall be granted.
 - d. Any customer requesting the issuance of a fire hydrant meter shall file an application with the Meter Section. The customer must complete a "Fire Hydrant Meter Application" (Tab 1) which includes the name of the company, the party responsible for payment, Social Security number and/or California ID, requested location of the meter (a detailed map signifying an exact location), local contact person, local phone number, a contractor's license (or a business license), description of specific water use, duration of use at the site and full name and address of the person responsible for payment.
 - e. At the time of the application the customer will pay their fees according to the schedule set forth in the Rate Book of Fees and Charges, located in the City Clerk's Office. All fees must be paid by check, money order or cashiers check, made payable to the City Treasurer. Cash will not be accepted.
 - f. No fire hydrant meters shall be furnished or relocated for any customer with a delinquent account with the Water Department.
 - g. After the fees have been paid and an account has been created, the

CITY OF SAN DIEGO CALIFORNIA DEPARTMENT INSTRUCTIONS	NUMBER DI 55.27	DEPARTMENT Water Department
SUBJECT FIRE HYDRANT METER PROGRAM (FORMERLY: CONSTRUCTION METER PROGRAM)	PAGE 6 OF 10	EFFECTIVE DATE October 15, 2002
	SUPERSEDES DI 55.27	DATED April 21, 2000

meter shall be installed within 48 hours (by the second business day). For an additional fee, at overtime rates, meters can be installed within 24 hours (within one business day).

4.7 Relocation of Existing Fire Hydrant Meters

- a. The customer shall call the Fire Hydrant Meter Hotline (herein referred to as “Hotline”), a minimum of 24 hours in advance, to request the relocation of a meter. A fee will be charged to the existing account, which must be current before a work order is generated for the meter’s relocation.
- b. The customer will supply in writing the address where the meter is to be relocated (map page, cross street, etc). The customer must update the original Fire Hydrant Meter Application with any changes as it applies to the new location.
- c. Fire hydrant meters shall be read on a monthly basis. While fire hydrant meters and backflow devices are in service, commodity, base fee and damage charges, if applicable, will be billed to the customer on a monthly basis. If the account becomes delinquent, the meter will be removed.

4.8 Disconnection of Fire Hydrant Meter

- a. After ten (10) months a “Notice of Discontinuation of Service” (Tab 3) will be issued to the site and the address of record to notify the customer of the date of discontinuance of service. An extension can only be granted in writing from the Water Department Director for up to 90 additional days (as stated in Section 4.6C) and a copy of the extension shall be forwarded to the Meter Shop Supervisor. If an extension has not been approved, the meter will be removed after twelve (12) months of use.
- b. Upon completion of the project the customer will notify the Meter Services office via the Hotline to request the removal of the fire hydrant meter and appurtenances. A work order will be generated

CITY OF SAN DIEGO CALIFORNIA DEPARTMENT INSTRUCTIONS	NUMBER DI 55.27	DEPARTMENT Water Department
SUBJECT FIRE HYDRANT METER PROGRAM (FORMERLY: CONSTRUCTION METER PROGRAM)	PAGE 7 OF 10	EFFECTIVE DATE October 15, 2002
	SUPERSEDES DI 55.27	DATED April 21, 2000

for removal of the meter.

- c. Meter Section staff will remove the meter and backflow prevention assembly and return it to the Meter Shop. Once returned to the Meter Shop the meter and backflow will be tested for accuracy and functionality.
- d. Meter Section Staff will contact and notify Customer Services of the final read and any charges resulting from damages to the meter and backflow or its appurtenance. These charges will be added on the customer's final bill and will be sent to the address of record. Any customer who has an outstanding balance will not receive additional meters.
- e. Outstanding balances due may be deducted from deposits and any balances refunded to the customer. Any outstanding balances will be turned over to the City Treasurer for collection. Outstanding balances may also be transferred to any other existing accounts.

5. **EXCEPTIONS**

- 5.1 Any request for exceptions to this policy shall be presented, in writing, to the Customer Support Deputy Director, or his/her designee for consideration.

6. **MOBILE METER**

- 6.1 Mobile meters will be allowed on a case by case basis. All mobile meters will be protected by an approved backflow assembly and the minimum requirement will be a Reduced Pressure Principal Assembly. The two types of Mobile Meters are vehicle mounted and floating meters. Each style of meters has separate guidelines that shall be followed for the customer to retain service and are described below:

- a) **Vehicle Mounted Meters:** Customer applies for and receives a City owned Fire Hydrant Meter from the Meter Shop. The customer mounts the meter on the vehicle and brings it to the Meter Shop for

CITY OF SAN DIEGO CALIFORNIA DEPARTMENT INSTRUCTIONS	NUMBER DI 55.27	DEPARTMENT Water Department
SUBJECT FIRE HYDRANT METER PROGRAM (FORMERLY: CONSTRUCTION METER PROGRAM)	PAGE 8 OF 10	EFFECTIVE DATE October 15, 2002
	SUPERSEDES DI 55.27	DATED April 21, 2000

inspection. After installation is approved by the Meter Shop the vehicle and meter shall be brought to the Meter Shop on a monthly basis for meter reading and on a quarterly basis for testing of the backflow assembly. Meters mounted at the owner's expense shall have the one year contract expiration waived and shall have meter or backflow changed if either fails.

b) **Floating Meters:** Floating Meters are meters that are not mounted to a vehicle. **(Note: All floating meters shall have an approved backflow assembly attached.)** The customer shall submit an application and a letter explaining the need for a floating meter to the Meter Shop. The Fire Hydrant Meter Administrator, after a thorough review of the needs of the customer, (i.e. number of jobsites per day, City contract work, lack of mounting area on work vehicle, etc.), may issue a floating meter. At the time of issue, it will be necessary for the customer to complete and sign the "Floating Fire Hydrant Meter Agreement" which states the following:

- 1) The meter will be brought to the Meter Shop at 2797 Caminito Chollas, San Diego on the third week of each month for the monthly read by Meter Shop personnel.
- 2) Every other month the meter will be read and the backflow will be tested. This date will be determined by the start date of the agreement.

If any of the conditions stated above are not met the Meter Shop has the right to cancel the contract for floating meter use and close the account associated with the meter. The Meter Shop will also exercise the right to refuse the issuance of another floating meter to the company in question.

Any Fire Hydrant Meter using reclaimed water shall not be allowed use again with any potable water supply. The customer shall incur the cost of replacing the meter and backflow device in this instance.

CITY OF SAN DIEGO CALIFORNIA DEPARTMENT INSTRUCTIONS	NUMBER DI 55.27	DEPARTMENT Water Department
SUBJECT FIRE HYDRANT METER PROGRAM (FORMERLY: CONSTRUCTION METER PROGRAM)	PAGE 9 OF 10	EFFECTIVE DATE October 15, 2002
	SUPERSEDES DI 55.27	DATED April 21, 2000

7. **FEE AND DEPOSIT SCHEDULES**

7.1 **Fees and Deposit Schedules:** The fees and deposits, as listed in the Rate Book of Fees and Charges, on file with the Office of the City Clerk, are based on actual reimbursement of costs of services performed, equipment and materials. These deposits and fees will be amended, as needed, based on actual costs. Deposits, will be refunded at the end of the use of the fire hydrant meter, upon return of equipment in good working condition and all outstanding balances on account are paid. Deposits can also be used to cover outstanding balances.

All fees for equipment, installation, testing, relocation and other costs related to this program are subject to change without prior notification. The Mayor and Council will be notified of any future changes.

8. **UNAUTHORIZED USE OF WATER FROM A HYDRANT**

8.1 Use of water from any fire hydrant without a properly issued and installed fire hydrant meter is theft of City property. Customers who use water for unauthorized purposes or without a City of San Diego issued meter will be prosecuted.

8.2 If any unauthorized connection, disconnection or relocation of a fire hydrant meter, or other connection device is made by anyone other than authorized Water Department personnel, the person making the connection will be prosecuted for a violation of San Diego Municipal Code, Section 67.15. In the case of a second offense, the customer's fire hydrant meter shall be confiscated and/or the deposit will be forfeited.

8.3 Unauthorized water use shall be billed to the responsible party. Water use charges shall be based on meter readings, or estimates when meter readings are not available.

8.4 In case of unauthorized water use, the customer shall be billed for all applicable charges as if proper authorization for the water use had been obtained, including but not limited to bi-monthly service charges, installation charges and removal charges.

CITY OF SAN DIEGO CALIFORNIA DEPARTMENT INSTRUCTIONS	NUMBER DI 55.27	DEPARTMENT Water Department
SUBJECT FIRE HYDRANT METER PROGRAM (FORMERLY: CONSTRUCTION METER PROGRAM)	PAGE 10 OF 10	EFFECTIVE DATE October 15, 2002
	SUPERSEDES DI 55.27	DATED April 21, 2000

- 8.5 If damage occurs to Water Department property (i.e. fire hydrant meter, backflow, various appurtenances), the cost of repairs or replacements will be charged to the customer of record (applicant).

**Larry Gardner
Water Department Director**

- Tabs: 1. Fire Hydrant Meter Application
2. Construction & Maintenance Related Activities With No Return To Sewer
3. Notice of Discontinuation of Service

APPENDIX

Administering Division: Customer Support Division

Subject Index: Construction Meters
Fire Hydrant
Fire Hydrant Meter Program
Meters, Floating or Vehicle Mounted
Mobile Meter
Program, Fire Hydrant Meter

Distribution: DI Manual Holders



Application for Fire Hydrant Meter (EXHIBIT A)

(For Office Use Only)

NS REQ	FAC#
DATE	BY

METER SHOP (619) 527-7449

Meter Information

Application Date	Requested Install Date:
------------------	-------------------------

Fire Hydrant Location: (Attach Detailed Map//Thomas Bros. Map Location or Construction drawing.) <u>Zip:</u>	<u>T.B.</u>	<u>G.B. (CITY USE)</u>
Specific Use of Water:		
Any Return to Sewer or Storm Drain, If so, explain:		
Estimated Duration of Meter Use: <input type="text"/>	<input type="checkbox"/>	Check Box if Reclaimed Water

Company Information

Company Name:			
Mailing Address:			
City:	State:	Zip:	Phone: ()
*Business license#		*Contractor license#	
A Copy of the Contractor's license OR Business License is required at the time of meter issuance.			
Name and Title of Billing Agent: <small>(PERSON IN ACCOUNTS PAYABLE)</small>			Phone: ()
Site Contact Name and Title:			Phone: ()
Responsible Party Name:			Title:
Cal ID#			Phone: ()
Signature:		Date:	
Guarantees Payment of all Charges Resulting from the use of this Meter. Insures that employees of this Organization understand the proper use of Fire Hydrant Meter			

Fire Hydrant Meter Removal Request	Requested Removal Date:
Provide Current Meter Location if Different from Above:	
Signature:	Title: Date:
Phone: ()	Pager: ()

<input type="checkbox"/> City Meter	<input type="checkbox"/> Private Meter
Contract Acct #:	Deposit Amount: \$ 936.00 Fees Amount: \$ 62.00
Meter Serial #	Meter Size: 05 Meter Make and Style: 6-7
Backflow #	Backflow Size: Backflow Make and Style:
Name: Solola & Euclid CR Obstruction DS Appendix B - Fire Hydrant Meter Program	Signature: Date: 66 Page

WATER USES WITHOUT ANTICIPATED CHARGES FOR RETURN TO SEWER

Auto Detailing
Backfilling
Combination Cleaners (Vactors)
Compaction
Concrete Cutters
Construction Trailers
Cross Connection Testing
Dust Control
Flushing Water Mains
Hydro Blasting
Hydro Seeing
Irrigation (for establishing irrigation only; not continuing irrigation)
Mixing Concrete
Mobile Car Washing
Special Events
Street Sweeping
Water Tanks
Water Trucks
Window Washing

Note:

1. If there is any return to sewer or storm drain, then sewer and/or storm drain fees will be charges.

Date

Name of Responsible Party
Company Name and Address
Account Number: _____

Subject: Discontinuation of Fire Hydrant Meter Service

Dear Water Department Customer:

The authorization for use of Fire Hydrant Meter # _____, located at *(Meter Location Address)* ends in 60 days and will be removed on or after *(Date Authorization Expires)*. Extension requests for an additional 90 days must be submitted in writing for consideration 30 days prior to the discontinuation date. If you require an extension, please contact the Water Department, or mail your request for an extension to:

City of San Diego
Water Department
Attention: Meter Services
2797 Caminito Chollas
San Diego, CA 92105-5097

Should you have any questions regarding this matter, please call the Fire Hydrant Hotline at (619) _____ - _____.

Sincerely,

Water Department

APPENDIX C

MATERIALS TYPICALLY ACCEPTED BY CERTIFICATE OF COMPLIANCE

Materials Typically Accepted by Certificate of Compliance

1. Soil amendment
2. Fiber mulch
3. PVC or PE pipe up to 16 inch diameter
4. Stabilizing emulsion
5. Lime
6. Preformed elastomeric joint seal
7. Plain and fabric reinforced elastomeric bearing pads
8. Steel reinforced elastomeric bearing pads
9. Waterstops (Special Condition)
10. Epoxy coated bar reinforcement
11. Plain and reinforcing steel
12. Structural steel
13. Structural timber and lumber
14. Treated timber and lumber
15. Lumber and timber
16. Aluminum pipe and aluminum pipe arch
17. Corrugated steel pipe and corrugated steel pipe arch
18. Structural metal plate pipe arches and pipe arches
19. Perforated steel pipe
20. Aluminum underdrain pipe
21. Aluminum or steel entrance tapers, pipe downdrains, reducers, coupling bands and slip joints
22. Metal target plates
23. Paint (traffic striping)
24. Conductors
25. Painting of electrical equipment
26. Electrical components
27. Engineering fabric
28. Portland Cement
29. PCC admixtures
30. Minor concrete, asphalt
31. Asphalt (oil)
32. Liquid asphalt emulsion
33. Epoxy

APPENDIX D
SAMPLE CITY INVOICE

City of San Diego, Field Engineering Div., 9485 Aero Drive, SD CA 92123						Contractor's Name:					
Project Name:						Contractor's Address:					
SAP No. (WBS/IO/CC)											
City Purchase Order No.						Contractor's Phone #:			Invoice No.		
Resident Engineer (RE):						Contractor's Fax #:			Invoice Date:		
RE Phone#:			RE Fax#:			Contact Name:			Billing Period:		
Item #	Item Description	Contract Authorization				Previous Estimate		This Estimate		Totals to Date	
		Unit	Qty	Price	Extension	%/QTY	Amount	% / QTY	Amount	% / QTY	Amount
1	2 Parallel 4" PVC C900	LF	1,380	\$34.00	\$46,920.00						
2	48" Primary Steel Casing	LF	500	\$1,000.00	\$500,000.00						
3	2 Parallel 12" Secondary Steel	LF	1,120	\$53.00	\$59,360.00						
4	Construction and Rehab of PS 49	LS	1	\$150,000.00	\$150,000.00						
5	Demo	LS	1	\$14,000.00	\$14,000.00						
6	Install 6' High Chain Link Fence	LS	1	\$5,600.00	\$5,600.00						
7	General Site Restoration	LS	1	\$3,700.00	\$3,700.00						
8	10" Gravity Sewer	LF	10	\$292.00	\$2,920.00						
9	4" Blow Off Valves	EA	2	\$9,800.00	\$19,600.00						
10	Bonds	LS	1	\$16,000.00	\$16,000.00						
11	Field Orders	AL	1	80,000	\$80,000.00						
11.1	Field Order 1	LS	5,500	\$1.00	\$5,500.00						
11.2	Field Order 2	LS	7,500	\$1.00	\$7,500.00						
11.3	Field Order 3	LS	10,000	\$1.00	\$10,000.00						
11.4	Field Order 4	LS	6,500	\$1.00	\$6,500.00						
12	Certified Payroll	LS	1	\$1,400.00	\$1,400.00						
CHANGE ORDERS											
Change Order 1			4,890								
Items 1-4					\$11,250.00						
Item 5-Deduct Bid Item 3		LF	120	-\$53.00	(\$6,360.00)						
Change Order 2			160,480								
Items 1-3					\$95,000.00						
Item 4 Deduct Bid Item 1		LF	380	-\$340.00	(\$12,920.00)						
Item 5-Encrease bid Item 9		LF	8	\$9,800.00	\$78,400.00						
Change Order 3 (Close Out)			-121,500								
Item 1 Deduct Bid Item 3			53	-500.00	(\$26,500.00)						
Item 2 Deduct Bid Item 4		LS	-1	45,000.00	(\$45,000.00)						
Items 3-9			1	-50,500.00	(\$50,500.00)						
SUMMARY								Total This	\$ -	Total Billed	\$0.00
A. Original Contract Amount						Retention and/or Escrow Payment Schedule					
B. Approved Change Order 1 Thru 3						Total Retention Required as of this billing					
C. Total Authorized Amount (A+B)						Previous Retention Withheld in PO or in Escrow					
D. Total Billed to Date						Add'l Amt to Withhold in PO/Transfer in Escrow:					
E. Less Total Retention (5% of D)						Amt to Release to Contractor from PO/Escrow:					
F. Less Total Previous Payments											
G. Payment Due Less Retention						Contractor Signature and Date:					
H. Remaining Authorized Amount											

APPENDIX E
LOCATION MAP

SOLOLA & EUCLID CR OBSTRUCTION DS

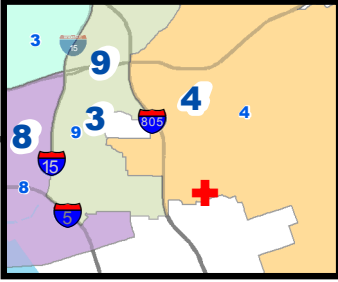

Legend

 Solola & Euclid CR Obstruction DS



No Scale



THIS MAP/DATA IS PROVIDED WITHOUT WARRANTY OF ANY KIND, EITHER EXPRESS OR IMPLIED, INCLUDING, BUT NOT LIMITED TO, THE IMPLIED WARRANTIES OR MERCHANTABILITY AND FITNESS FOR A PARTICULAR PURPOSE. Note: This product may contain information reproduced with permission granted by RAND McNALLY & COMPANY to SanGIS. This map is copyrighted by RAND McNALLY & COMPANY. It is unlawful to produce all or any part thereof, whether for personal use or resale, without the prior, written permission of RAND McNALLY & COMPANY.

ATTACHMENT F

INTENTIONALLY LEFT BLANK

TABLE OF CONTENTS

DESCRIPTION

PAGE NUMBER

Volume 2 - Bidding Documents

The following forms must be completed in their entirety and submitted with the Bid. Include the form(s) even if the information does not apply. Where the information does not apply write in N/A. Failure to include any of the forms may cause the Bid to be deemed **non-responsive**. If you are uncertain or have any questions about any required information, contact the City no later than 14 days prior to Bid due date.

1. Bid/Proposal..... 3
2. Non-Collusion Affidavit to be executed by Bidder and Submitted with Bid under 23 USC 112 and PCC 7106 6
3. Contractors Certification of Pending Actions 7
4. Equal Benefits Ordinance Certification of Compliance..... 8
5. Proposal (Bid) 9
6. Form AA35 - List of Subcontractors 13
7. Form AA40 - Named Equipment/Material Supplier List 14

BIDDING DOCUMENTS

PROPOSAL

Bidder's General Information

To the City of San Diego:

Pursuant to "Notice Inviting Bids", specifications, and requirements on file with the City Clerk, and subject to all provisions of the Charter and Ordinances of the City of San Diego and applicable laws and regulations of the United States and the State of California, the undersigned hereby proposes to furnish to the City of San Diego, complete at the prices stated herein, the items or services hereinafter mentioned. The undersigned further warrants that this bid is not made in the interest of, or on behalf of, any undisclosed person, partnership, company, association, organization, or corporation; that the bid is genuine and not collusive or sham; that the bidder has not directly or indirectly induced or solicited any other bidder to put in a false or sham bid, and has not directly or indirectly colluded, conspired, connived, or agreed with any bidder or anyone else to put in a sham bid, or that anyone shall refrain from bidding; that the bidder has not in any manner, directly or indirectly, sought by agreement, communication, or conference with anyone to fix the bid price of the bidder or any other bidder, or to fix any overhead, profit, or cost element of the bid price, or of that of any other bidder, or to secure any advantage against the public body awarding the contract of anyone interested in the proposed contract; that all statements contained in the bid are true; and, further, that the bidder has not, directly or indirectly, submitted his or her bid price or any breakdown thereof, or the contents thereof, or divulged information or data relative thereto, or paid, and will not pay, any fee to any corporation, partnership, company, association, organization, bid depository, or to any member or agent thereof to effectuate a collusive or sham bid.

The undersigned bidder(s) further warrants that bidder(s) has thoroughly examined and understands the entire Contract Documents (plans and specifications) and the Bidding Documents therefore, and that by submitting said Bidding Documents as its bid proposal, bidder(s) acknowledges and is bound by the entire Contract Documents, including any addenda issued thereto, as such Contract Documents incorporated by reference in the Bidding Documents.

IF A SOLE OWNER OR SOLE CONTRACTOR SIGN HERE:

- (1) Name under which business is conducted _____
- (2) Signature (Given and surname) of proprietor _____
- (3) Place of Business (Street & Number) _____
- (4) City and State _____ Zip Code _____
- (5) Telephone No. _____ Facsimile No. _____
- (6) Email Address _____

IF A PARTNERSHIP, SIGN HERE:

- (1) Name under which business is conducted _____

BIDDING DOCUMENTS

(2) Name of each member of partnership, indicate character of each partner, general or special (limited):

(3) Signature (Note: Signature must be made by a general partner)

Full Name and Character of partner

(4) Place of Business (Street & Number) _____

(5) City and State _____ Zip Code _____

(6) Telephone No. _____ Facsimile No. _____

(7) Email Address _____

IF A CORPORATION, SIGN HERE:

(1) Name under which business is conducted NEW CENTURY CONST, INC.

(2) Signature, with official title of officer authorized to sign for the corporation:

Lee P. Sheuberg

(Signature)

LEE P. SHEUBERG, A

(Printed Name)

PRESIDENT

(Title of Officer)

(Impress Corporate Seal Here)

(3) Incorporated under the laws of the State of CALIF.

(4) Place of Business (Street & Number) 9119 EMERALD GROVE AVE.

(5) City and State LAKESIDE, CA Zip Code 92040

(6) Telephone No. 619-390-3300 Facsimile No. 619-390-3311

(7) Email Address newcenturyconstruction@yahoo.com

BIDDING DOCUMENTS

THE FOLLOWING SECTIONS MUST BE FILLED IN BY ALL PROPOSERS:

In accordance with the "NOTICE INVITING BIDS", the bidder holds a California State Contractor's license for the following classification(s) to perform the work described in these specifications:

LICENSE CLASSIFICATION A, B

LICENSE NO. 614517 EXPIRES 9-30-16

This license classification must also be shown on the front of the bid envelope. This license classification on the bid envelope may cause return of the bid.

TAX IDENTIFICATION NUMBER (TIN): [REDACTED]

Email [REDACTED] on@yahoo.com

THIS PROPOSAL MUST BE NOTARIZED BELOW:

I certify, under penalty of perjury, that the representations made herein regarding my State Contractor's license number, classification and expiration date are true and correct.

CALIFORNIA ALL-PURPOSE ACKNOWLEDGEMENT

A notary public or other officer completing this certificate verifies only the identity of the individual who signed the document to which this certificate is attached, and not the truthfulness, accuracy, or validity of that document.

State of California
County of (San Diego)

On 1-14-15 before me, Susan Leggett, Notary Public
(insert name and title of the officer)

personally appeared Lee P. Shellberg II who proved to me on the basis of satisfactory evidence to be the person(s) whose name(s) is/are subscribed to the within instrument and acknowledged to me that he/she/they executed the same in his/her/their authorized capacity(ies); and that by his/her/their signature(s) on the instrument the person(s), or the entity upon behalf of which the person(s) acted, executed the instrument.

I certify under PENALTY OF PERJURY under the laws of the State of California that the foregoing paragraph is true and correct.

WITNESS my hand and official seal.

Signature Susan Leggett
Susan Leggett, Notary Public

(Seal)



BIDDING DOCUMENTS

NON-COLLUSION AFFIDAVIT TO BE EXECUTED BY BIDDER AND SUBMITTED WITH BID UNDER 23 UNITED STATES CODE 112 AND PUBLIC CONTRACT CODE 7106

State of California)
) ss.
County of SAN DIEGO)

LOE P. SHELLBERG, II, being first duly sworn, deposes and says that he or she is PRESIDENT of the party making the foregoing bid that the bid is not made in the interest of, or on behalf of, any undisclosed person, partnership, company, association, organization, or corporation; that the bid is genuine and not collusive or sham; that the bidder has not directly or indirectly induced or solicited any other bidder to put in a false or sham bid, and has not directly or indirectly colluded, conspired, connived, or agreed with any bidder or anyone else to put in a sham bid, or that anyone shall refrain from bidding; that the bidder has not in any manner, directly or indirectly, sought by agreement, communication, or conference with anyone to fix the bid price of the bidder or any other bidder, or to fix any overhead, profit, or cost element of the bid price, or of that of any other bidder, or to secure any advantage against the public body awarding the contract of anyone interested in the proposed contract; that all statements contained in the bid are true; and further, that the bidder has not, directly or indirectly, submitted his or her bid price or any breakdown thereof, or the contents thereof, or divulged information or data relative thereto, or paid, and will not pay, any fee to any corporation, partnership, company association, organization, bid depository, or to any member or agent thereof to effectuate a collusive or sham bid.

Signed: [Signature]
Title: PRESIDENT

Subscribed and sworn to before me this 14 day of JAN, 2015
[Signature]
Notary Public

(SEAL)



BIDDING DOCUMENTS

CONTRACTORS CERTIFICATION OF PENDING ACTIONS

As part of its bid or proposal (Non-Price Proposal in the case of Design-Build contracts), the Bidder shall provide to the City a list of all instances within the past 10 years where a complaint was filed or pending against the Bidder in a legal or administrative proceeding alleging that Bidder discriminated against its employees, subcontractors, vendors or suppliers, and a description of the status or resolution of that complaint, including any remedial action taken.

CHECK ONE BOX ONLY.

- The undersigned certifies that within the past 10 years the Bidder has NOT been the subject of a complaint or pending action in a legal administrative proceeding alleging that Bidder discriminated against its employees, subcontractors, vendors or suppliers.
- The undersigned certifies that within the past 10 years the Bidder has been the subject of a complaint or pending action in a legal administrative proceeding alleging that Bidder discriminated against its employees, subcontractors, vendors or suppliers. A description of the status or resolution of that complaint, including any remedial action taken and the applicable dates is as follows:

DATE OF CLAIM	LOCATION	DESCRIPTION OF CLAIM	LITIGATION (Y/N)	STATUS	RESOLUTION/REMEDIAL ACTION TAKEN
	N/A				

Contractor Name: NEW CENTURY CONST, INC.

Certified By LEE P. SNEUBERG, II Title PRES.

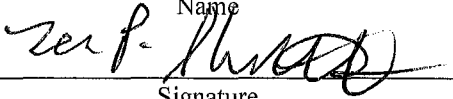
Name

Signature

Date 1-14-15

USE ADDITIONAL FORMS AS NECESSARY

BIDDING DOCUMENTS

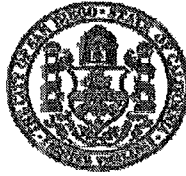
**EQUAL BENEFITS ORDINANCE
CERTIFICATION OF COMPLIANCE**



For additional information, contact:
CITY OF SAN DIEGO
EQUAL BENEFITS PROGRAM
 202 C Street, MS 9A, San Diego, CA 92101
 Phone (619) 533-3948 Fax (619) 533-3220

COMPANY INFORMATION	
Company Name: <u>NEW CENTURY CONST. INC.</u>	Contact Name: <u>LEE SHELBERG</u>
Company Address: <u>919 EMERALD GROVE AVE</u> <u>LAKEVIEW, CA 92040</u>	Contact Phone: <u>619-390-3300</u>
	Contact Email: <u>newcenturyconstruction@yahoo.com</u>

CONTRACT INFORMATION	
Contract Title: <u>Solola & Euclid L157212-085-1</u>	Start Date:
Contract Number (if no number, state location):	End Date:

SUMMARY OF EQUAL BENEFITS ORDINANCE REQUIREMENTS

The Equal Benefits Ordinance [EBO] requires the City to enter into contracts only with contractors who certify they will provide and maintain equal benefits as defined in SDMC §22.4302 for the duration of the contract. To comply:

- Contractor shall offer equal benefits to employees with spouses and employees with domestic partners.
 - Benefits include health, dental, vision insurance; pension/401(k) plans; bereavement, family, parental leave; discounts, child care; travel/relocation expenses; employee assistance programs; credit union membership; or any other benefit.
 - Any benefit not offer an employee with a spouse, is not required to be offered to an employee with a domestic partner.
- Contractor shall post notice of firm's equal benefits policy in the workplace and notify employees at time of hire and during open enrollment periods.
- Contractor shall allow City access to records, when requested, to confirm compliance with EBO requirements.
- Contractor shall submit *EBO Certification of Compliance*, signed under penalty of perjury, prior to award of contract.

NOTE: This summary is provided for convenience. Full text of the EBO and Rules Implementing the EBO are available at www.sandiego.gov/administration.

CONTRACTOR EQUAL BENEFITS ORDINANCE CERTIFICATION

Please indicate your firm's compliance status with the EBO. The City may request supporting documentation.

I affirm **compliance** with the EBO because my firm (*contractor must select one reason*):

- Provides equal benefits to spouses and domestic partners.
- Provides no benefits to spouses or domestic partners.
- Has no employees.
- Has collective bargaining agreement(s) in place prior to January 1, 2011, that has not been renewed or expired.

I request the City's approval to pay affected employees a cash equivalent in lieu of equal benefits and verify my firm made a reasonable effort but is not able to provide equal benefits upon contract award. I agree to notify employees of the availability of a cash equivalent for benefits available to spouses but not domestic partners and to continue to make every reasonable effort to extend all available benefits to domestic partners.

It is unlawful for any contractor to knowingly submit any false information to the City regarding equal benefits or cash equivalent associated with the execution, award, amendment, or administration of any contract. [San Diego Municipal Code §22.4307(a)]

Under penalty of perjury under laws of the State of California, I certify the above information is true and correct. I further certify that my firm understands the requirements of the Equal Benefits Ordinance and will provide and maintain equal benefits for the duration of the contract or pay a cash equivalent if authorized by the City.

LEE P. SHELBERG, JR. - PRESIDENT [Signature] 1-14-15

Name/Title of Signatory Signature Date

FOR OFFICIAL CITY USE ONLY

Receipt Date: EBO Analyst: Approved Not Approved – Reason:

(Rev 02/15/2011)

BIDDING DOCUMENTS

PROPOSAL (BID)

The Bidder agrees to the construction of **Solola & Euclid CR Obstruction DS**, for the City of San Diego, in accordance with these contract documents for the prices listed below. The Bidder guarantees the Contract Price for a period of 120 days (90 days for federally funded contracts and contracts valued at \$500,000 or less) from the date of Bid opening to Award of the Contract. The duration of the Contract Price guarantee shall be extended by the number of days required for the City to obtain all items necessary to fulfill all conditions precedent e.g., bond and insurance.

Item	Quantity	Unit	NAICS	Payment Reference	Description	Unit Price	Extension
BASE BID							
1	1	LS	524126	2-4.1	Bonds (Payment and Performance)	 	\$ 3,000.-
2	1	LS	541370	2-9.2	Survey Services	 	\$ 3,500.-
3	1	LS	238990	7-9.1.1	Video Recording of Pre-existing Conditions	 	\$ 600.-
4	1	LS	237310	7-10.2.6	Traffic Control	 	\$ 7,000.-
5	1	AL	237310	7-10.2.6	Portable Changeable Message Signs (PCMS) - Type I	 	\$2,500.00
6	3	EA	238210	9-3.1	Remove/Relocate Existing Traffic Sign	\$ 250.-	\$ 750.-
7	1	LS	237310	9-3.4.1	Mobilization	 	\$ 1,500.-
8	1	AL		9-3.5	Field Orders - Type II	 	\$10,690.60
9	2	TON	237310	302-3.2	Asphalt Pavement Repair	\$ 500.-	\$ 1,000.-
10	6	TON	237310	302-5.9	Asphalt Concrete	\$ 700.-	\$ 4,200.-
11	818	SF	237310	302-6.8	Concrete Pavement	\$ 11.-	\$ 8,998.-
12	2	EA	237310	303-5.9	Contractor Date Stamp and Impressions	\$ 200.-	\$ 400.-
13	55	LF	237310	303-5.9	Median Curb & Gutter (Type B-2)	\$ 35.-	\$ 1,925.-
14	80	SF	237310	303-5.9	Remove and Replace Cross Gutter	\$ 15.-	\$ 1,200.-
15	350	SF	237310	303-5.9	Concrete Driveway (Contiguous)	\$ 10.-	\$ 3,500.-
16	55	LF	237310	303-5.9	Additional Curb and Gutter	\$ 35.-	\$ 1,925.-

BIDDING DOCUMENTS

Item	Quantity	Unit	NAICS	Payment Reference	Description	Unit Price	Extension
17	32	LF	237310	303-5.9	6" Monolithic Curb	\$ 30.-	\$ 960.-
18	548	SF	237310	303-5.9	New Sidewalk Installation	\$ 8.-	\$ 4,384.-
19	40	SF	237310	303-5.9	Additional Sidewalk Removal and Replacement	\$ 10.-	\$ 400.-
20	1	EA	237310	303-5.10.2	Curb Ramp Type A with Detectable Warning Tiles	\$ 2,500.-	\$ 2,500.-
21	1	EA	237310	303-5.10.2	Curb Ramp Type C2 with Detectable Warning Tiles	\$ 2,500.-	\$ 2,500.-
22	1	EA	237310	303-5.10.2	Modified 2-Curb Ramp Passageway with Detectable Warning Tiles (Sht. 3 Detail 'B')	\$ 2,800.-	\$ 2,800.-
23	1	EA	237310	303-5.10.2	Modified 3-Curb Ramp Passageway with Detectable Warning Tiles (Sht. 3 Detail 'A')	\$ 3,000.-	\$ 3,000.-
24	28	EA	237310	307-2	Type E Detector Loop	\$ 500.-	\$ 14,000.-
25	2	EA	237310	307-2	Type Q Bike Detector Loop	\$ 550.-	\$ 1,100.-
26	393	LF	238210	307-2	2" PVC Conduit in AC Pavement Per City Standards	\$ 33.-	\$ 12,969.-
27	62	LF	238210	307-2	3" PVC Conduit in AC Pavement Per City Standards	\$ 36.-	\$ 2,232.-
28	4	EA	238210	307-2	#5 Pull Box	\$ 500.-	\$ 2,000.-
29	1	EA	238210	307-2	Relocate Electrical Pullbox	\$ 600.-	\$ 600.-
30	3	EA	238210	307-2	Type 1-A Pole (7') and Foundation	\$ 1,200.-	\$ 3,600.-
31	3	EA	238210	307-2	TP-1-T Pedestrian Signal	\$ 960.-	\$ 2,880.-
32	8	EA	238210	307-2	ADA Pedestrian Pushbutton	\$ 360.-	\$ 2,880.-
33	4	EA	238210	307-2	Removal of Existing PED Heads	\$ 500.-	\$ 2,000.-
34	8	EA	238210	307-2	PED Countdown Timers	\$ 500.-	\$ 4,000.-
35	1	EA	238210	307-2	EVPE for 2 Approaches (Dual)	\$ 1,200.-	\$ 1,200.-

2,880.-

BIDDING DOCUMENTS

Item	Quantity	Unit	NAICS	Payment Reference	Description	Unit Price	Extension
36	140	LF	238210	307-2	EVPE Lead-In Cable	\$ 12.-	\$ 1,680.-
37	4	EA	238210	307-2	EVPE Detector	\$ 3,000.-	\$ 12,000.-
38	1	LS	237310	314-4.4.6	Thermoplastic Stripping, Crosswalks and Markings	 	\$ 4,400.-
39	1	LS	541330	701-13.9.5	Water Pollution Control Program Development	 	\$ 500.-
40	1	LS	237990	701-13.9.5	Water Pollution Control Program Implementation	 	\$ 1,500.-
ESTIMATED TOTAL BASE BID:							\$ 138,773.60

TOTAL BID PRICE FOR BID (Items 1 through 40 inclusive) amount written in words:

ONE HUNDRED THIRTY EIGHT THOUSAND SEVEN HUNDRED SEVENTY THREE DOLLARS AND SIXTY CENTS

The Bid shall contain an acknowledgment of receipt of all addenda, the numbers of which shall be filled in on the Bid form. If an addendum or addenda has been issued by the City and not noted as being received by the Bidder, this proposal shall be rejected as being **non-responsive**. The following addenda have been received and are acknowledged in this bid:

The names of all persons interested in the foregoing proposal as principals are as follows:

LEE P. SHEUBERG, II

PRESIDENT

(HOLDS ALL OFFICES)

IMPORTANT NOTICE: If Bidder or other interested person is a corporation, state secretary, treasurer, and manager thereof; if a co-partnership, state true name of firm, also names of all individual co-partners composing firm; if Bidder or other interested person is an individual, state first and last names in full.

BIDDING DOCUMENTS

Bidder: NEW CENTURY CONSTRUCTION, INC.
Title: PRESIDENT
Business Address: 9119 EMERALD GROVE AVE.
Place of Business: LAKEVILLE, CA 92040
Place of Residence: LAKEVILLE, CA
Signature: [Handwritten Signature]

NOTES:

- A. The City shall determine the low Bid based on the Base Bid alone.
- B. Prices and notations shall be in ink or typewritten. All corrections (which have been initiated by the Bidder using erasures, strike out, line out, or "white-out") shall be typed or written in with ink adjacent thereto, and shall be initialed in ink by the person signing the bid proposal.
- C. Failure to initial all corrections made in the bidding documents shall cause the Bid to be rejected as **non-responsive** and ineligible for further consideration.
- D. Blank spaces must be filled in, using figures. Bidder's failure to submit a price for any Bid item that requires the Bidder to submit a price shall render the Bid **non-responsive** and shall be cause for its rejection.
- E. Unit prices shall be entered for all unit price items. Unit prices shall not exceed two (2) decimal places. If the Unit prices entered exceed two (2) decimal places, the City will only use the first two digits after the decimal points without rounding up or down.
- F. All extensions of the unit prices bid will be subject to verification by the City. In the case of inconsistency or conflict between the product of the Quantity x Unit Price and the Extension, the product shall govern.
- G. In the case of inconsistency or conflict, between the sums of the Extensions with the estimated total Bid, the sum of the Extensions shall govern.
- H. Bids shall not contain any recapitulation of the Work. Conditional Bids will be rejected as being **non-responsive**. Alternative proposals will not be considered unless called for.
- I. Subcontractors' License Number must be filled in. Failure to provide the information specified may deem the bidder **non-responsive**.

BIDDING DOCUMENTS

LIST OF SUBCONTRACTORS

In accordance with the requirements provided in the "Subletting and Subcontracting Fair Practices Act", Division 2, Part 1, Chapter 4 of the Public Contract Code, the Bidder shall list below the name and address of each Subcontractor who will perform work, labor, render services or specially fabricates and installs a portion [type] of the work or improvement, in an amount in excess of 0.5% of the Contractor's total Bid. The Bidder shall also list below the portion of the work which will be done by each subcontractor under this Contract. The Contractor shall list only one Subcontractor for each portion of the Work. The **DOLLAR VALUE** of the total Bid to be performed shall be stated for all subcontractors listed. Failure to comply with this requirement shall result in the Bid being rejected as **non-responsive** and ineligible for award. The Bidder's attention is directed to the Special Provisions - General; Paragraph 2-3 Subcontracts, which stipulates the percent of the Work to be performed with the Bidders' own forces. The Bidder shall list all SLBE, ELBE, DBE, DVBE, MBE, WBE, OBE, SDB, WoSB, HUBZone, and SDVOSB Subcontractors that Bidders are seeking recognition towards achieving any mandatory, voluntary, or both subcontracting participation percentages.

Subcontractors' License Number must be filled in. Failure to provide the information specified may deem the bidder **non-responsive**.

NAME, ADDRESS AND TELEPHONE NUMBER OF SUBCONTRACTOR	CONSTRUCTOR OR DESIGNER	SUBCONTRACTOR LICENSE NUMBER	TYPE OF WORK	DOLLAR VALUE OF SUBCONTRACT (MUST BE FILLED OUT)	MBE, WBE, DBE, DVBE, OBE, ELBE, SLBE, SDB, WoSB, HUBZone, OR SDVOSB	WHERE CERTIFIED	CHECK IF JOINT VENTURE PARTNERSHIP
Name: <u>PERRY ELECTRIC</u> Address: <u>P.O. Box 710130</u> City: <u>San Diego</u> State: <u>CA</u> Zip: <u>92172</u> Phone: <u>619-449-0085</u> Email: <u>Chanson@perryelectricSD.com</u>	<u>Const.</u>	<u>147931</u>	<u>Electric</u>	<u>52,464.-</u>			
Name: <u>STATEWIDE STRIPES</u> Address: <u>P.O. Box 660710</u> City: <u>San Diego</u> State: <u>CA</u> Zip: <u>92160</u> Phone: <u>858-560-6887</u> Email: <u>mattd@statewidestripes.com</u>	<u>Const.</u>	<u>788286</u>	<u>Striping</u>	<u>3,490.-</u>			

① As appropriate, Bidder shall identify Subcontractor as one of the following and shall include a valid proof of certification (except for OBE, SLBE and ELBE):

Certified Minority Business Enterprise	MBE	Certified Woman Business Enterprise	WBE
Certified Disadvantaged Business Enterprise	DBE	Certified Disabled Veteran Business Enterprise	DVBE
Other Business Enterprise	OBE	Certified Emerging Local Business Enterprise	ELBE
Certified Small Local Business Enterprise	SLBE	Small Disadvantaged Business	SDB
Woman-Owned Small Business	WoSB	HUBZone Business	HUBZone
Service-Disabled Veteran Owned Small Business	SDVOSB		

② As appropriate, Bidder shall indicate if Subcontractor is certified by:

City of San Diego	CITY	State of California Department of Transportation	CALTRANS
California Public Utilities Commission	CPUC	San Diego Regional Minority Supplier Diversity Council	SRMSDC
State of California's Department of General Services	CADoGS	City of Los Angeles	LA
State of California	CA	U.S. Small Business Administration	SBA

The Bidder will not receive any subcontracting participation percentages if the Bidder fails to submit the required proof of certification.

0.4219
P.F.R.

BIDDING DOCUMENTS

LIST OF SUBCONTRACTORS

In accordance with the requirements provided in the "Subletting and Subcontracting Fair Practices Act", Division 2, Part 1, Chapter 4 of the Public Contract Code, the Bidder shall list below the name and address of each Subcontractor who will perform work, labor, render services or specially fabricates and installs a portion [type] of the work or improvement, in an amount in excess of 0.5% of the Contractor's total Bid. The Bidder shall also list below the portion of the work which will be done by each subcontractor under this Contract. The Contractor shall list only one Subcontractor for each portion of the Work. The **DOLLAR VALUE** of the total Bid to be performed shall be stated for all subcontractors listed. Failure to comply with this requirement shall result in the Bid being rejected as **non-responsive** and ineligible for award. The Bidder's attention is directed to the Special Provisions - General; Paragraph 2-3 Subcontracts, which stipulates the percent of the Work to be performed with the Bidders' own forces. The Bidder shall list all SLBE, ELBE, DBE, DVBE, MBE, WBE, OBE, SDB, WoSB, HUBZone, and SDVOSB Subcontractors that Bidders are seeking recognition towards achieving any mandatory, voluntary, or both subcontracting participation percentages.

Subcontractors' License Number must be filled in. Failure to provide the information specified may deem the bidder **non-responsive**.

NAME, ADDRESS AND TELEPHONE NUMBER OF SUBCONTRACTOR	CONSTRUCTOR OR DESIGNER	SUBCONTRACTOR LICENSE NUMBER	TYPE OF WORK	DOLLAR VALUE OF SUBCONTRACT (MUST BE FILLED OUT)	MBE, WBE, DBE, DVBE, OBE, ELBE, SLBE, SDB, WoSB, HUBZone, OR SDVOSB	WHERE CERTIFIED	CHECK IF JOINT VENTURE PARTNERSHIP
Name: <u>Geometria Inc</u> Address: <u>107 G GRAND AVE</u> City: <u>ESCONDIDO</u> State: <u>CA</u> Zip: <u>92025</u> Phone: <u>760-741-2089</u> Email: <u>info@geometriarurvey.com</u>	<u>Const.</u>	<u>1031 PW</u>	<u>Surveying</u>	<u>2,600.-</u>			
Name: _____ Address: _____ City: _____ State: _____ Zip: _____ Phone: _____ Email: _____							

① As appropriate, Bidder shall identify Subcontractor as one of the following and shall include a valid proof of certification (except for OBE, SLBE and ELBE):

Certified Minority Business Enterprise	MBE	Certified Woman Business Enterprise	WBE
Certified Disadvantaged Business Enterprise	DBE	Certified Disabled Veteran Business Enterprise	DVBE
Other Business Enterprise	OBE	Certified Emerging Local Business Enterprise	ELBE
Certified Small Local Business Enterprise	SLBE	Small Disadvantaged Business	SDB
Woman-Owned Small Business	WoSB	HUBZone Business	HUBZone
Service-Disabled Veteran Owned Small Business	SDVOSB		

② As appropriate, Bidder shall indicate if Subcontractor is certified by:

City of San Diego	CITY	State of California Department of Transportation	CALTRANS
California Public Utilities Commission	CPUC	San Diego Regional Minority Supplier Diversity Council	SRMSDC
State of California's Department of General Services	CADoGS	City of Los Angeles	LA
State of California	CA	U.S. Small Business Administration	SBA

The Bidder will not receive any subcontracting participation percentages if the Bidder fails to submit the required proof of certification.

BIDDING DOCUMENTS

NAMED EQUIPMENT/MATERIAL SUPPLIER LIST

The Bidder seeking the recognition of equipment, materials, or supplies obtained from Suppliers towards achieving any mandatory, voluntary, or both subcontracting participation percentages shall list the Supplier(s) on the Named Equipment/Material Supplier List. The Named Equipment/Material Supplier List, at a minimum, shall have the name, locations (City) and the **DOLLAR VALUE** of the Suppliers. The Bidder will be credited up to 60% of the amount to be paid to the Suppliers for such materials and supplies unless vendor manufactures or substantially alters materials and supplies in which case 100% will be credited. The Bidder is to indicate (Yes/No) whether listed firm is a supplier or manufacturer. In calculating the subcontractor participation percentages, vendors/suppliers will receive 60% credit of the listed **DOLLAR VALUE**, whereas manufacturers will receive 100% credit. If no indication provided, listed firm will be credited at 60% of the listed dollar value for purposes of calculating the Subcontractor Participation Percentage, Suppliers will receive 60% credit of the listed **DOLLAR VALUE**, whereas manufacturers will receive 100% credit. If no indication provided, listed firm will be credited at 60% of the listed **DOLLAR VALUE** for purposes of calculating the subcontractor participation percentages.

NAME, ADDRESS AND TELEPHONE NUMBER OF VENDOR/SUPPLIER	MATERIALS OR SUPPLIES	DOLLAR VALUE OF MATERIAL OR SUPPLIES (MUST BE FILLED OUT)	SUPPLIER (Yes/No)	MANUFACTURER (Yes/No)	MBE, WBE, DBE, DVBE, OBE, ELBE, SLBE, SDB, WoSB, HUBZone, OR SDVOSB ^①	WHERE CERTIFIED ^②
Name: _____ Address: _____ City: _____ State: _____ Zip: _____ Phone: _____ Email: _____	<i>me</i>					
Name: _____ Address: _____ City: _____ State: _____ Zip: _____ Phone: _____ Email: _____						

① As appropriate, Bidder shall identify Vendor/Supplier as one of the following and shall include a valid proof of certification (except for OBE, SLBE and ELBE):

Certified Minority Business Enterprise	MBE	Certified Woman Business Enterprise	WBE
Certified Disadvantaged Business Enterprise	DBE	Certified Disabled Veteran Business Enterprise	DVBE
Other Business Enterprise	OBE	Certified Emerging Local Business Enterprise	ELBE
Certified Small Local Business Enterprise	SLBE	Small Disadvantaged Business	SDB
Woman-Owned Small Business	WoSB	HUBZone Business	HUBZone
Service-Disabled Veteran Owned Small Business	SDVOSB		

② As appropriate, Bidder shall indicate if Vendor/Supplier is certified by:

City of San Diego	CITY	State of California Department of Transportation	CALTRANS
California Public Utilities Commission	CPUC	San Diego Regional Minority Supplier Diversity Council	SRMSDC
State of California's Department of General Services	CADoGS	City of Los Angeles	LA
State of California	CA	U.S. Small Business Administration	SBA

The Bidder will not receive any subcontracting participation percentages if the Bidder fails to submit the required proof of certification.

SOLOLA & EUCLID CR OBSTRUCTION DS

UNDERGROUND UTILITIES

AT LEAST THREE (3) WORKING DAYS PRIOR TO EXCAVATION, THE CONTRACTOR SHALL REQUEST A MARKOUT OF UNDERGROUND UTILITIES BY CALLING THE BELOW LISTED REGIONAL NOTIFICATION CENTER FOR AN INQUIRY IDENTIFICATION NUMBER: 1-800-422-4133 UNDERGROUND SERVICE ALERT (U.S.A.)

TRAFFIC CONTROL NOTES:

1. THE CONTRACTOR SHALL PER SECTION 7-10.2 OF THE CONTRACT SPECIAL PROVISIONS, PREPARE TRAFFIC CONTROL SHOP DRAWINGS AND SUBMIT THEM TO THE RESIDENT ENGINEER. THE SHOP DRAWINGS WILL BE SENT TO THE ENGINEERING TRAFFIC CONTROL SECTION FOR REVIEW AND APPROVAL. THE CONTRACTOR SHALL ALLOW A MINIMUM OF TWENTY (20) WORKING DAYS FOR REVIEW OF THE SHOP DRAWINGS. UPON APPROVAL OF THE TRAFFIC CONTROL PLAN, THE ENGINEERING TRAFFIC CONTROL SECTION WILL ISSUE A TRAFFIC CONTROL PLAN (TCP) PERMIT. WORK SHALL NOT BEGIN IN THE PUBLIC RIGHT OF WAY WITHOUT THE APPROVED TCP PERMIT.

GENERAL NOTES

- CONTRACTOR SHALL ASSUME SOLE AND COMPLETE RESPONSIBILITY FOR JOB SITE CONDITIONS DURING THE COURSE OF CONSTRUCTION OF THIS PROJECT INCLUDING SAFETY OF ALL PERSONS AND PROPERTY. THIS REQUIREMENT SHALL APPLY CONTINUOUSLY AND NOT BE LIMITED TO NORMAL WORKING HOURS.
- THE CONTRACTOR SHALL ENFORCE ALL SAFETY MEASURES, DESIGN, CONSTRUCT, AND MAINTAIN ALL SAFETY DEVICES, INCLUDING SHORING AND SHALL BE SOLELY RESPONSIBLE FOR CONFORMING TO ALL LOCAL, STATE AND FEDERAL SAFETY AND HEALTH STANDARDS, LAWS, AND REGULATIONS.
- ALL IMPROVEMENTS SHOWN, INCLUDING ELEVATIONS, SHALL BE CONFIRMED BY FIELD MEASUREMENTS PRIOR TO CONSTRUCTION.
- THE CONTRACTOR SHALL BE RESPONSIBLE FOR PROTECTING ALL SURVEY MONUMENTATION AND/OR BENCHMARKS THAT MAY BE AFFECTED BY CONSTRUCTION. SUCH POINTS SHALL BE REFERENCED AND REPLACED WITH APPROPRIATE MONUMENTATION BY A LICENSED LAND SURVEYOR OR A DULY-APPOINTED REGISTERED PROFESSIONAL ENGINEER. THE CONTRACTOR SHALL BE RESPONSIBLE FOR OBTAINING THE NECESSARY PERMITS AND APPOINTING A REGISTERED CIVIL ENGINEER AS REQUIRED BY THE LAND SURVEYOR'S ACT.
- BEFORE EXCAVATING FOR THIS CONTRACT, THE CONTRACTOR SHALL VERIFY LOCATION OF ALL UNDERGROUND UTILITIES.
- IF THERE IS ANY QUESTION REGARDING THESE PLANS OR FIELD STAKES, THE CONTRACTOR SHALL REQUEST AN INTERPRETATION BEFORE DOING ANY WORK BY CALLING THE CITY RESIDENT ENGINEER.
- LOCATIONS OF ALL EXISTING IMPROVEMENTS AND UTILITIES ARE APPROXIMATE. THE CONTRACTOR SHALL DETERMINE THE EXACT LOCATIONS AND VERIFY ALL CONDITIONS ON THE JOB SITE.
- THE CONTRACTOR SHALL COORDINATE THE BUS STOP CLOSURES AT LEAST TWO WEEKS BEFORE START OF CONSTRUCTION WITH MTS (OPERATIONS DEPARTMENT); MICHELE SHEPHERD AT (619) 238-0100 X6418.

STORM WATER PROTECTION

THIS PROJECT IS SUBJECT TO MUNICIPAL STORM WATER PERMIT ORDER NO. R9-2007-0001 AND WPCP.

WATER POLLUTION CONTROL NOTES:

THE CONTRACTOR SHALL, PER SECTION 701-13.9 OF 2012 WHITEBOOK, PREPARE WATER POLLUTION CONTROL SITE MANAGEMENT PLAN (WPCMP), PROTECT ALL NEW AND EXISTING STORM DRAIN INLET STRUCTURES FROM SEDIMENTATION RUNOFF, ROCK WASHING RUNOFF, OR ANY OTHER PROJECT SITE RUNOFF BY PLACING GRAVEL BAGS, FILTER FABRIC, OR OTHER SATISFACTORY METHOD APPROVED BY THE RESIDENT ENGINEER.

LIMITS OF WORK

SHEET NO.	DISCIPLINE CODE	TITLE	LIMITS
1	G-1	COVER SHEET	
2	D-1	DEMOLITION	NORTH WEST CORNER CURB & GUTTER AND SOLOLA AVE FROM EUCLID AVE EASTWARD FOR ±190 FEET
3	C-1	CURB RAMPS	INTERSECTION OF SOLOLA AVENUE AND EUCLID AVENUE
4	C-2	SIDEWALK	ALONG SOLOLA AVE EAST OF EUCLID AVENUE
5	T-1	TRAFFIC SIGNAL MODIFICATION	INTERSECTION OF SOLOLA AVENUE AND EUCLID AVENUE

DISCIPLINE CODE

- G GENERAL
- D DEMOLITION
- C CIVIL
- T TRAFFIC CONTROL

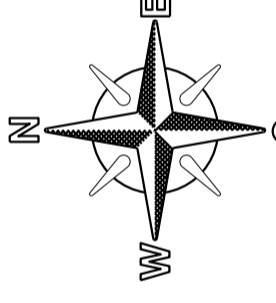
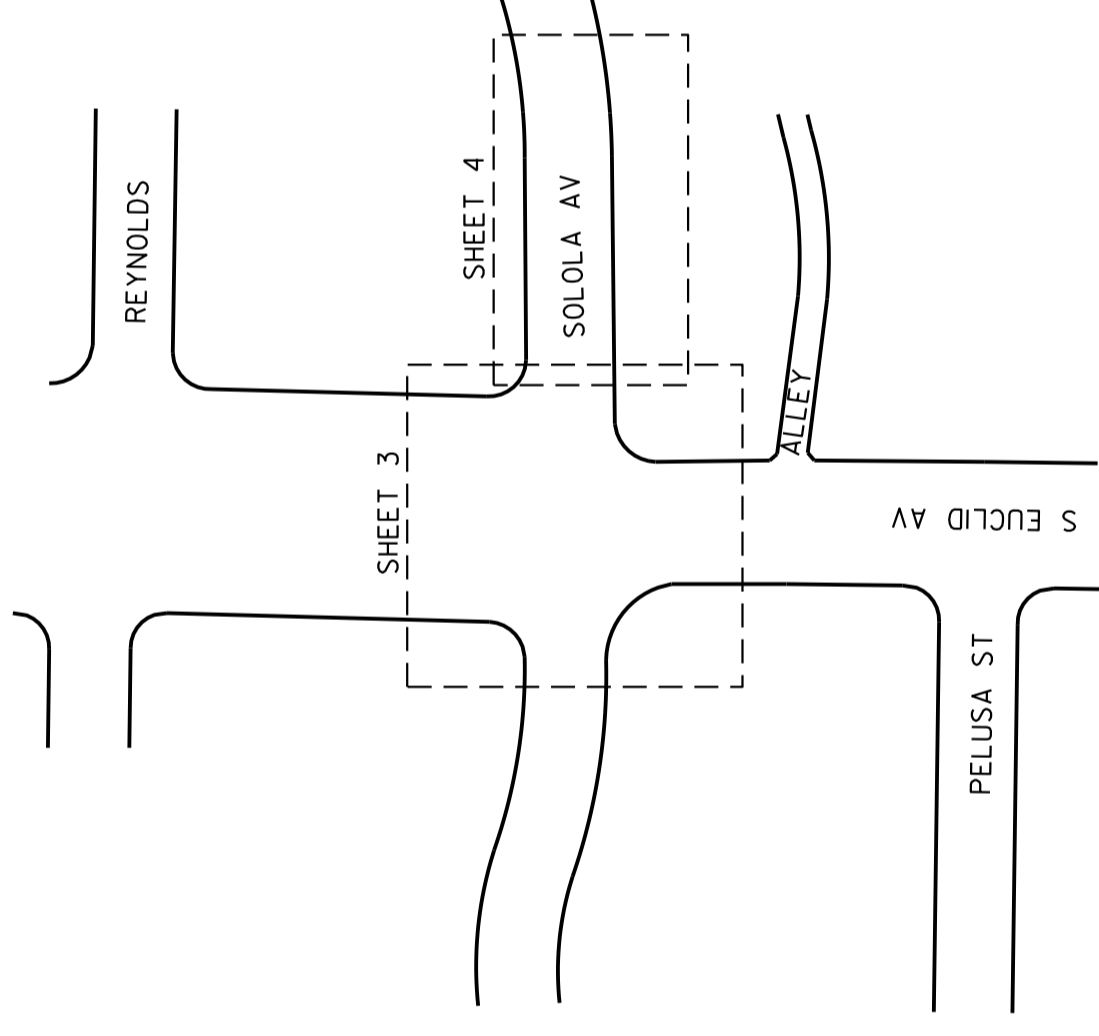

KEY MAP
NOT TO SCALE

WORK TO BE DONE

THE IMPROVEMENTS CONSIST OF THE FOLLOWING WORK TO BE DONE ACCORDING TO THESE PLANS, THE STANDARD SPECIFICATIONS AND THE STANDARD DRAWINGS OF THE CITY OF SAN DIEGO:

INSTALLATION OF NEW CURB, RAMPS, PEDESTRIAN ACCESS ROUTE THROUGH MEDIANS AND ADDITION OF NEW SIDEWALK AT SOLOLA AVE AND IMPROVEMENT OF TRAFFIC/PEDESTRIAN SIGNALS, PAVING AND STRIPING.

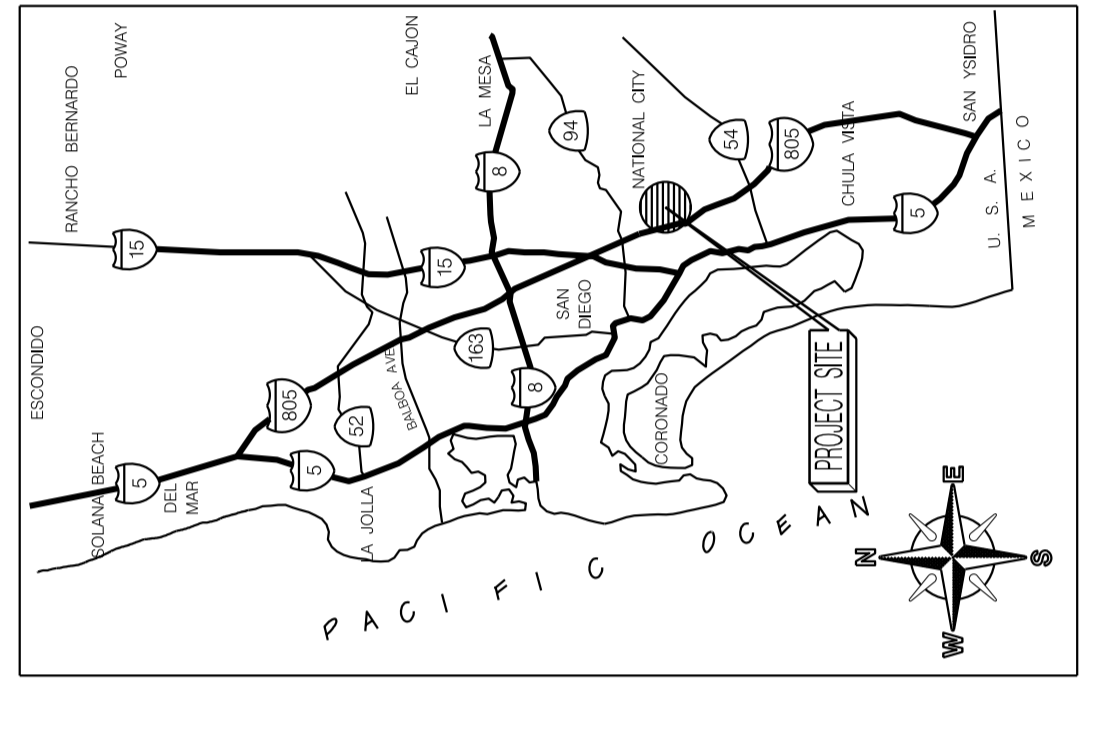

VICINITY MAP
NOT TO SCALE

STREET CLASSIFICATION

STREET NAME: SOLOLA AVENUE
COLLECTOR, ADT= NOT ON MACHINE COUNT

STREET NAME: EUCLID AVENUE
COLLECTOR, ADT= 10430

CITY REFERENCE DRAWINGS:

9207-L, 6064-B, 15398-D, THOMAS BROTHERS - 1290 6A

SURVEY FIELD DATA

REFERENCES:
MAPS: 3465, 2852, 3185

BASIS OF BEARINGS/COORDINATES:
THE BASIS OF BEARINGS FOR THIS PROJECT WAS DERIVED FROM A PREVIOUS STATIC GPS SURVEY, R.O.S. 14492, NAD 83, ZONE 6 (EPOCH 1993.35), UTILIZING RTK/GPS FIELD PROCEDURES WITH CALVRS BROADCAST DATE OF 2013.

CONTROL LOCALLY CONSTRAINED TO:
GPS 17 (PT# 20017) AND GPS 1237 (PT# 1237) IE: S 21° 48' 41" E.

BENCH:
NMBP EUCLID AND SOLOLA EL= 124.19* BASED ON NGVD 29 FEET AS SHOWN IN THE CITY OF SAN DIEGO BENCH BOOK.

L E G E N D

PROPOSED IMPROVEMENTS

STANDARD DRAWINGS
SDG-109, SDG-155, SDG-156,
SDG-159, SDG-160, G-10
SDG-151, SDG-154

CURB AND GUTTER
(SEE SHT 3)

CURB RAMP (SEE SHT 3)

DETECTABLE WARNING TILE
(COMPOSITE)

CONCRETE DRIVEWAY
(CONTIGUOUS SIDEWALK)

SAWCUT LINE

EXISTING IMPROVEMENTS

GAS LINE

WATER METER

FIRE HYDRANT

SEWER MAIN & MANHOLES

STORM DRAIN

EXISTING CONTOURS (MINOR)

EXISTING CONTOURS (MAJOR)

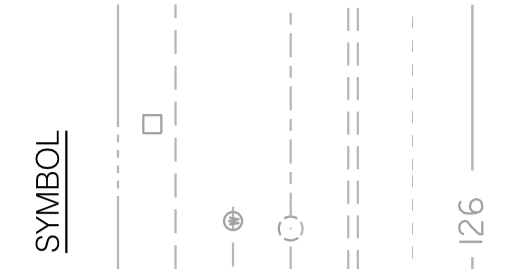
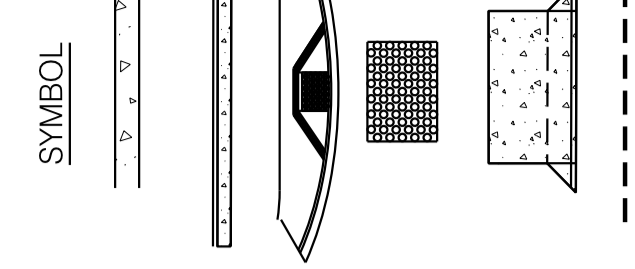

A B B R E V I A T I O N S

ABAND	ABANDONED	EL	ELEVATION	LP	LOW POINT
ABAND'D	ABANDONED	ELEC	ELECTRICAL	LT	LEFT
BC	BOTTOM OF CURB	EX	EXISTING	PROP	PROPOSED
BTWN	BETWEEN	FG	FINISH GRADE	P/L	PROPERTY LINE
CATV	CABLE TV	FL	FLOW LINE	RT	RIGHT OF WAY
∅	CENTER LINE	FS	FINISH SURFACE	R/W	RIGHT OF WAY
COND	CONDUIT	HP	HIGH POINT	UNK	UNKNOWN

G-1

PLANS FOR THE CONSTRUCTION OF
SOLOLA & EUCLID CR
OBSTRUCTION DS
COVER SHEET

CITY OF SAN DIEGO, CALIFORNIA PUBLIC WORKS DEPARTMENT SHEET 1 OF 5 SHEETS	WBS	B-13069
FOR CITY ENGINEER RANJA AMEN	DATE	8/25/14
DESIGNED BY SARAH CHAVEZ PROJECT MANAGER	APPROVED	DATE
PRINT NAME ORIGINAL	BY	DATE
DESCRIPTION	CM/PE	FILED
CONTRACTOR	DATE STARTED	
INSPECTOR	DATE COMPLETED	



CITY OF SAN DIEGO
PUBLIC WORKS PROJECT

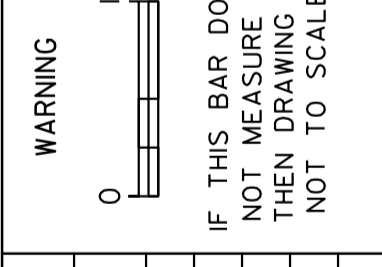

CHANGE	DATE	CONSTRUCTION CHANGE / ADDENDUM	AFFECTED OR ADDED SHEET NUMBERS	APPROVAL NO.

SOLOLA & EUCLID CR OBSTRUCTION DS

LEGEND

---	SAWCUT LINE
▨	REMOVE EX AC PAVEMENT
▩	REMOVE EX AC PAVEMENT, CURB & GUTTER
▧	REMOVE EX CONCRETE
▬	EX PAVEMENT STRIPING
—x—	EX FENCE
+	EX UTILITY POLE
⊕	EX FIRE HYDRANT
⊙	EX STREET LIGHT
⊕	EX TREE
⊕	EX STREET SIGN
⊕	EX ELEC STRUCT
⊕	TELEPHONE STRUCT
⊕	TRAFFIC STRUCT
⊕	CATV STRUCT
⊕	WATER METER
⊕	STORM DRAIN INLET
⊕	CATHODIC PREVENTATIVE TEST
⊕	EX SMALL TREE
⊕	SURVEY MARKER

NOTES

- ① REMOVE EX STRIPING
- ② REMOVE CURB AND GUTTER FROM STA. 1+21.75 TO STA. 1+67.11
- ③ PROTECT EX SIGNAL/LIGHT POLE IN PLACE
- ④ PROTECT IN PLACE EX UTILITY STRUCTURE AND RAISE IF NEEDED
- ⑤ PROTECT IN PLACE EXISTING STORM DRAIN INLET
- ⑥ REMOVE CURB AND GUTTER FROM STA. 2+30.87 TO STA. 2+51.43
- ⑦ PROTECT IN PLACE EX STREET LIGHT
- ⑧ PROTECT IN PLACE EX SURVEY MARKER
- ⑨ PROTECT IN PLACE EX STREET SIGN
- ⑩ SMALL BUSH TO BE REMOVED
- ⑪ EX DRIVEWAY TO BE REMOVED & REPLACED FROM STA. 3+02.76 TO STA. 3+19.09
- ⑫ EX DRIVEWAY TO BE REMOVED & REPLACED FROM STA. 3+81.20 TO STA. 4+01.61,
- ⑬ EX. SIDEWALK TO BE REMOVED FROM STA. 4+04.77 TO STA. 4+09.95, REPLACE WITH REGULAR SIDEWALK, CURB AND GUTTER
- ⑭ MOVE GUIDEWIRE (COORDINATE WITH SD&E)

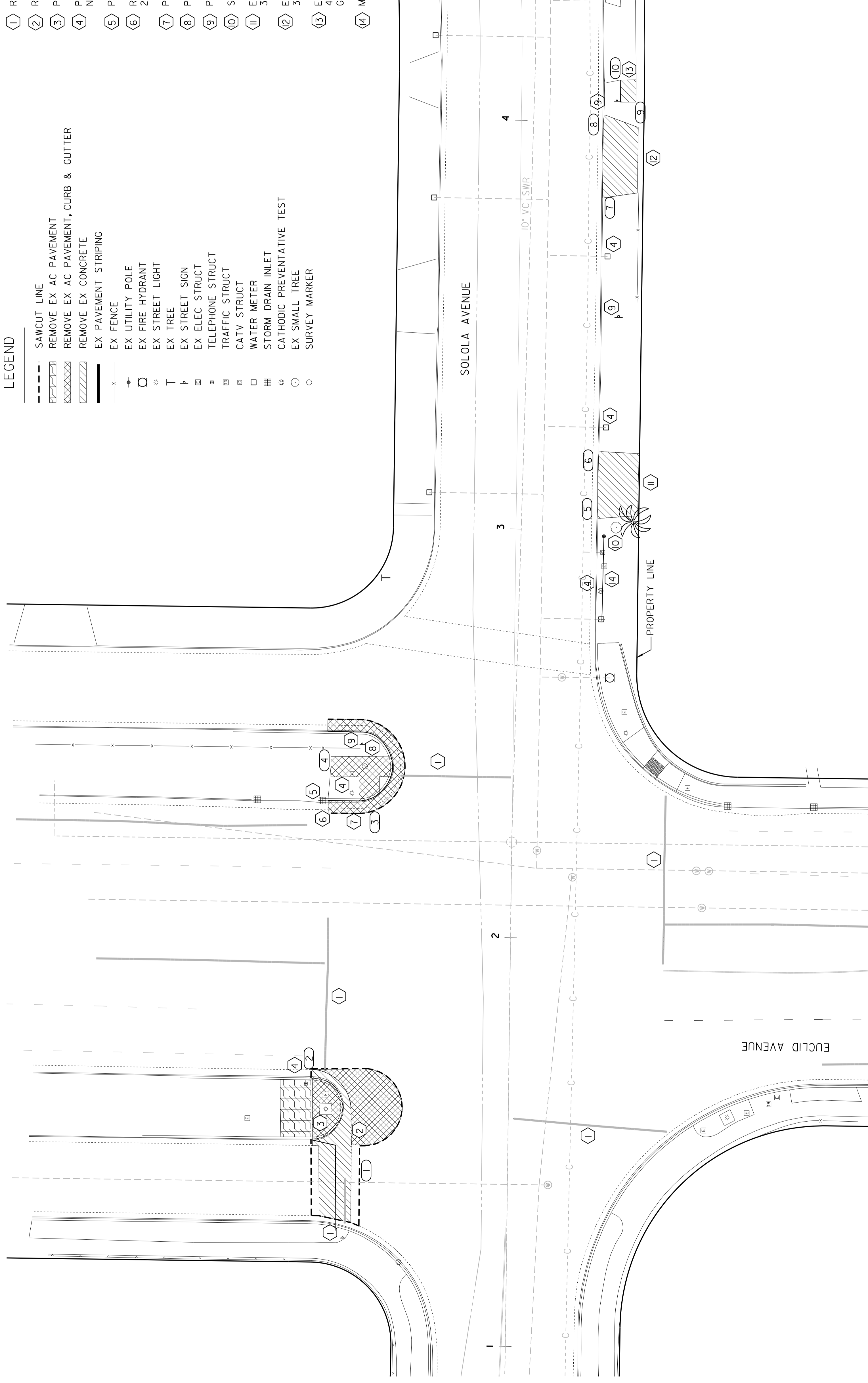

COORDINATE TABLE FROM CENTER LINE

NO.	NORTHING	EASTING	STATION	OFFSET	DESCRIPTION
①	1833216.75	6304664.71	1+30.78	42.00'	BEGIN SAW CUT & CONCRETE CURB/GUTTER REMOVAL
②	1833222.37	6304701.12	1+67.11	48.09'	END CONCRETE CURB/GUTTER REMOVAL
③	1833210.53	6304767.36	2+33.50	37.12'	BEGIN AC PAVEMENT REMOVAL
④	1833218.54	6304777.70	2+43.74	45.27'	END AC PAVEMENT REMOVAL
⑤	1833152.51	6304835.88	3+02.78	19.99'	BEGIN CONCRETE DRIVEWAY REMOVAL
⑥	1833151.35	6304852.23	3+19.13	20.03'	END CONCRETE DRIVEWAY REMOVAL
⑦	1833150.42	6304914.31	3+81.22	20.13'	BEGIN CONCRETE DRIVEWAY REMOVAL
⑧	1833147.00	6304934.54	1+01.46	20.79'	END CONCRETE DRIVEWAY REMOVAL
⑨	1833147.00	6304937.82	4+04.78	24.17'	BEGIN CONCRETE SIDEWALK REMOVAL
⑩	1833147.01	6304943.247	4+10.20	24.09'	END CONCRETE SIDEWALK REMOVAL

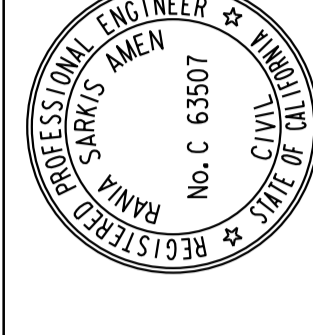
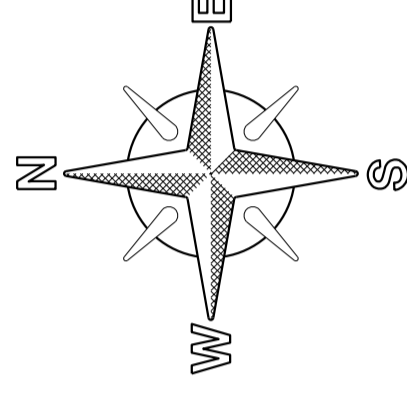

SOLOLA & EUCLID MEDIAN AND DRIVEWAY DEMOLITION

D-1

CITY OF SAN DIEGO, CALIFORNIA PUBLIC WORKS DEPARTMENT SHEET 2 OF 5 SHEETS	WBS B-13069
DESIGNED BY: SARAH CHAVEZ PROJECT MANAGER	DATE: 8/25/14
CHECKED BY: CECILIA MARISTELA PROJECT ENGINEER	DATE: _____
BY: _____	APPROVED: _____
DESCRIPTION: ORIGINAL	DATE: _____
DATE: _____	FILED: _____
CONTRACTOR: _____	DATE STARTED: _____
INSPECTOR: _____	DATE COMPLETED: _____
	1830444-6304407 CC888 COORDINATE
	37724-02-D

SOLOLA & EUCLID MEDIAN AND DRIVEWAY DEMOLITION

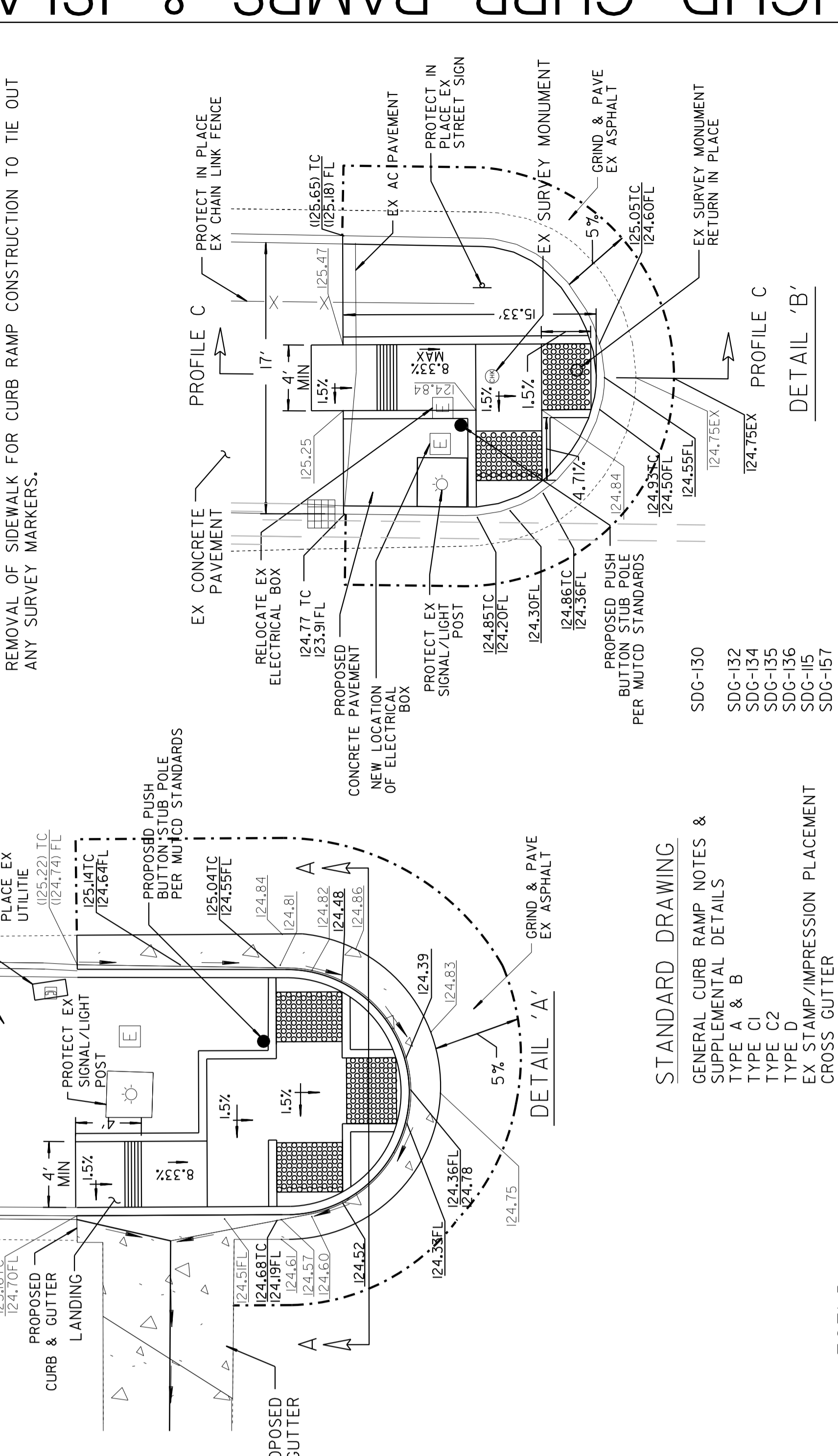
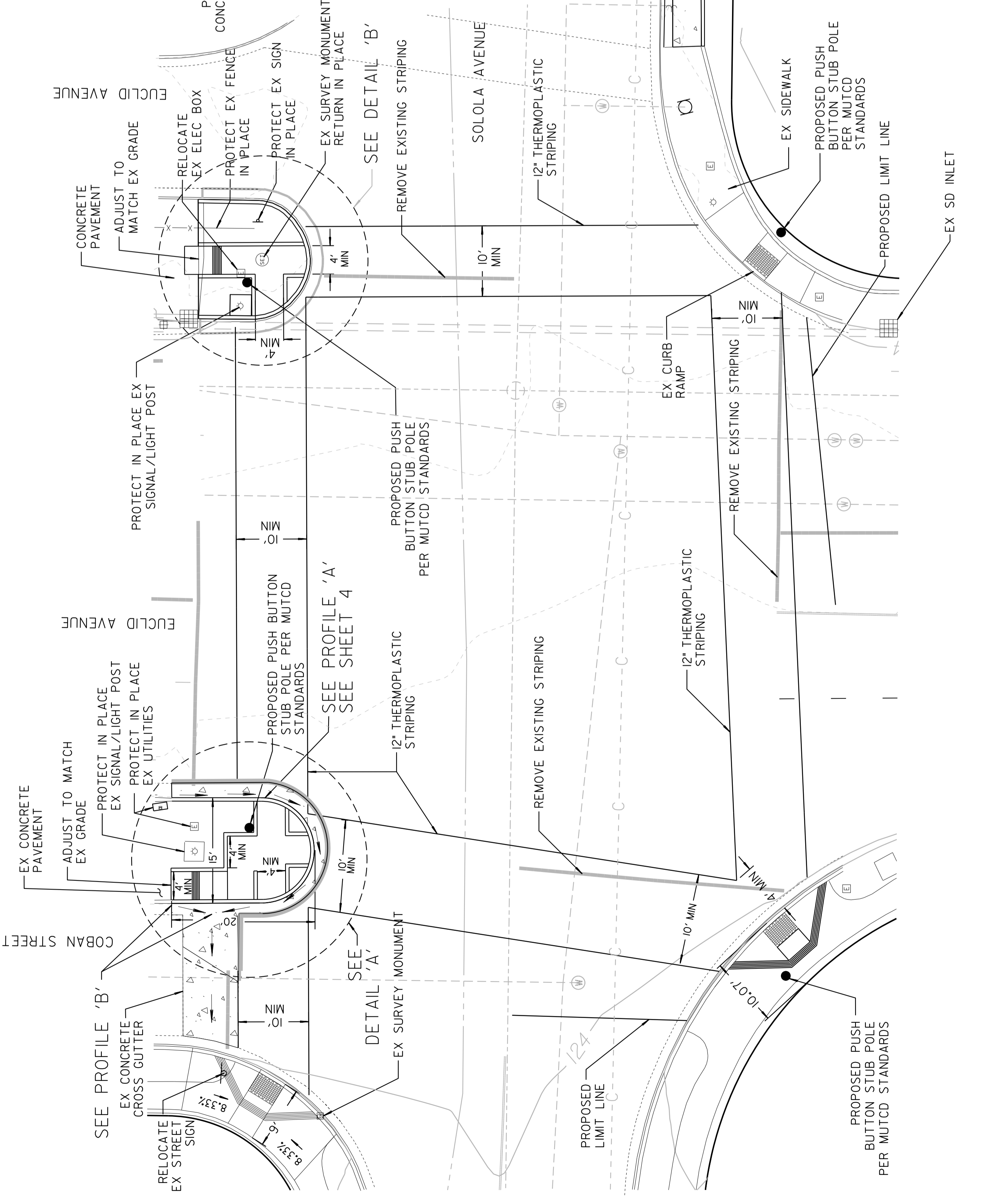
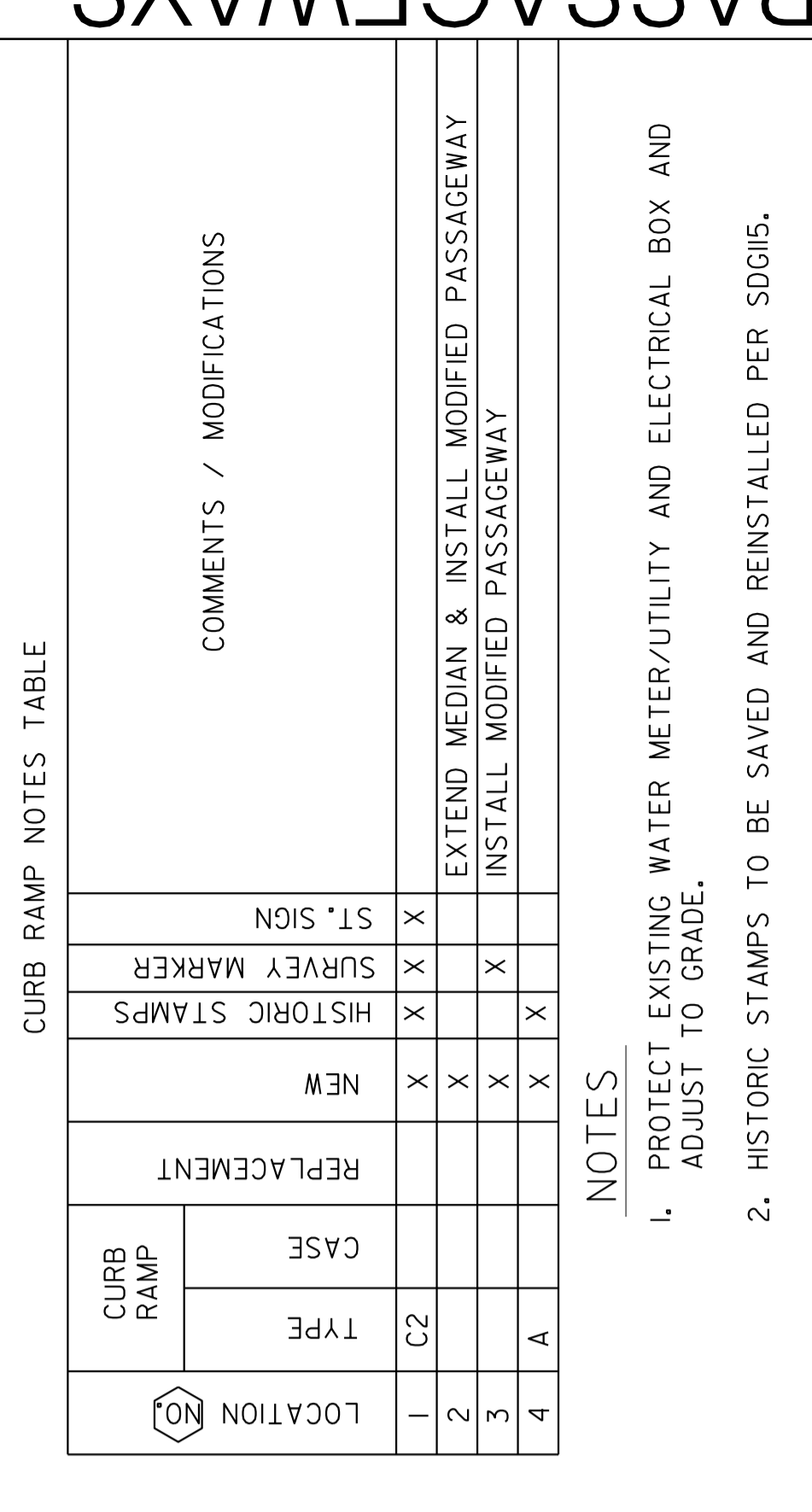
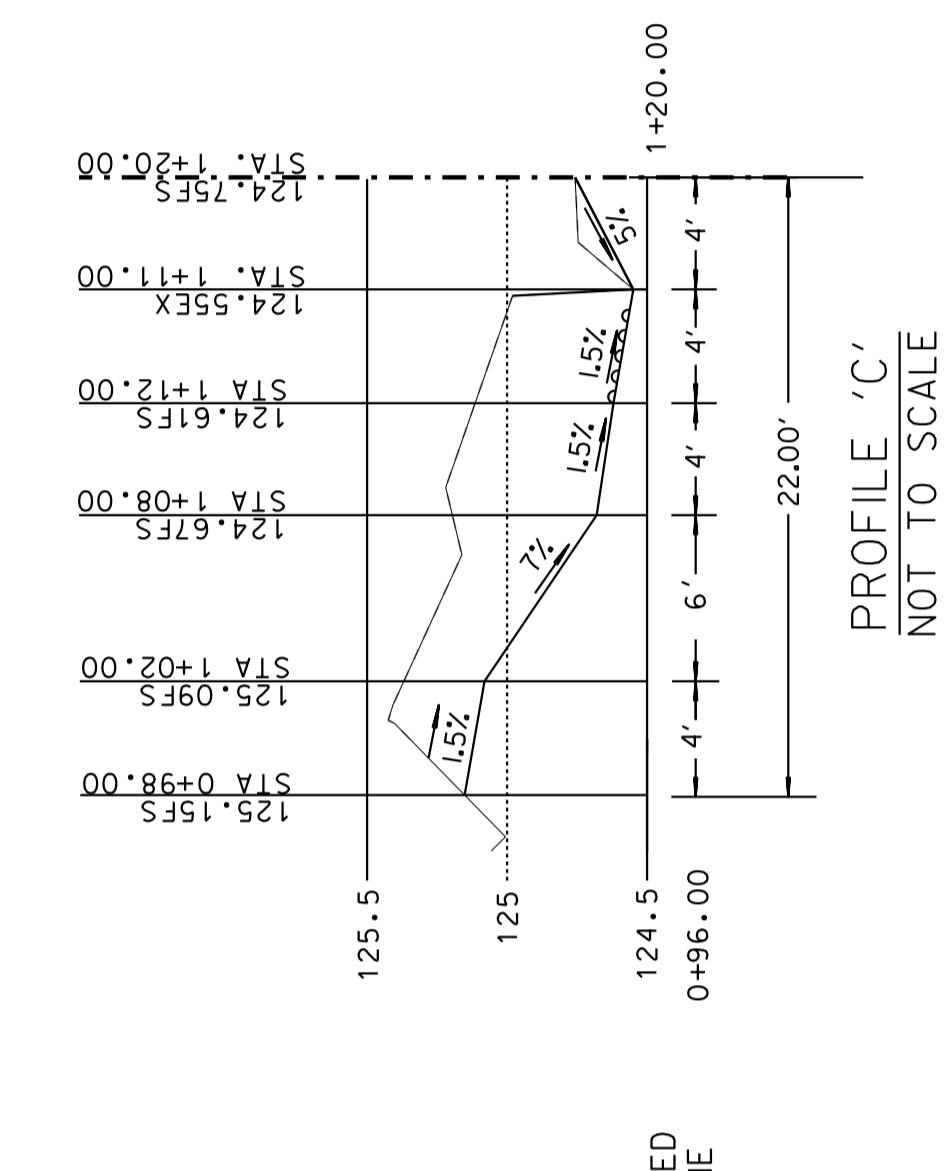
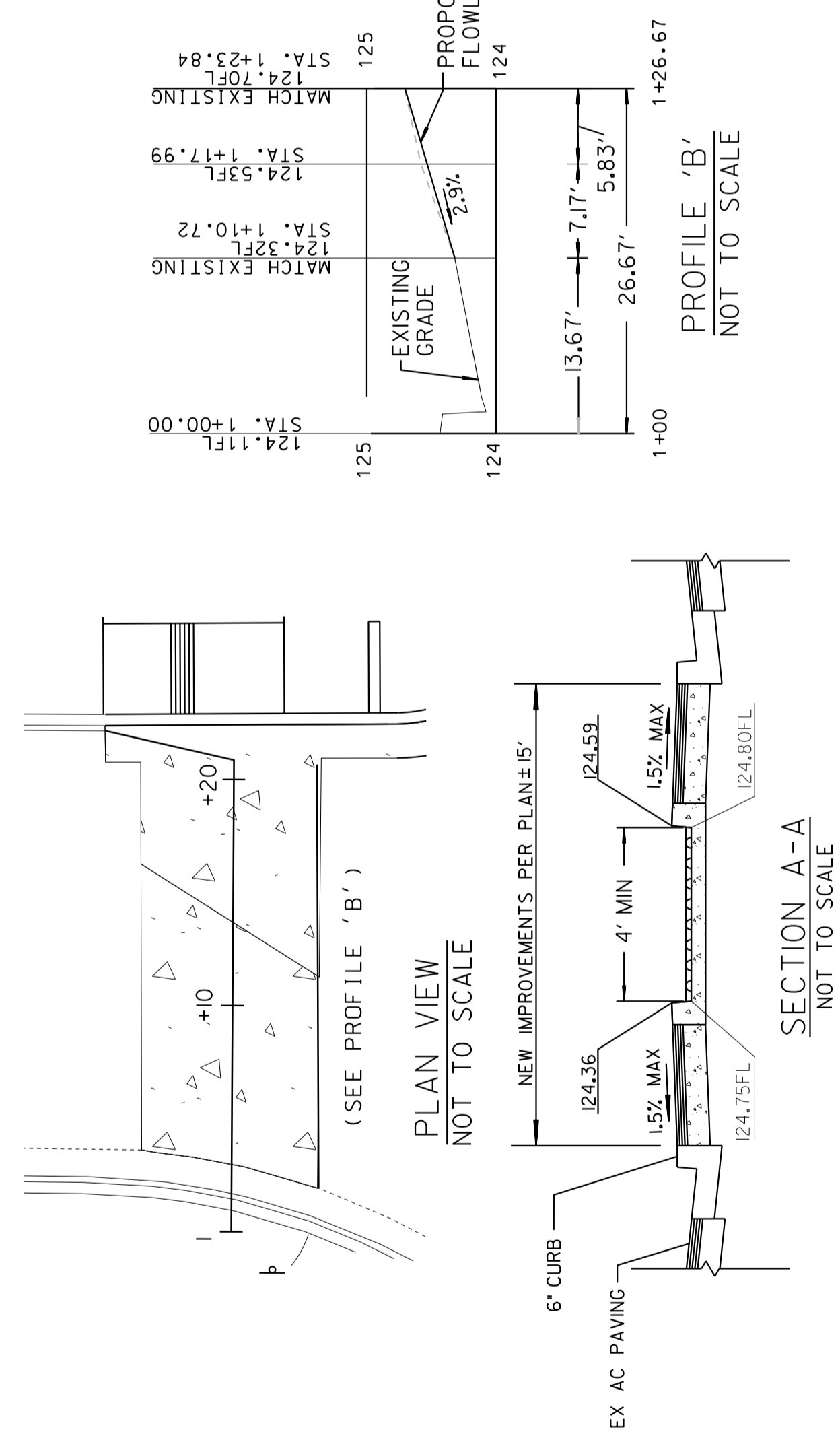
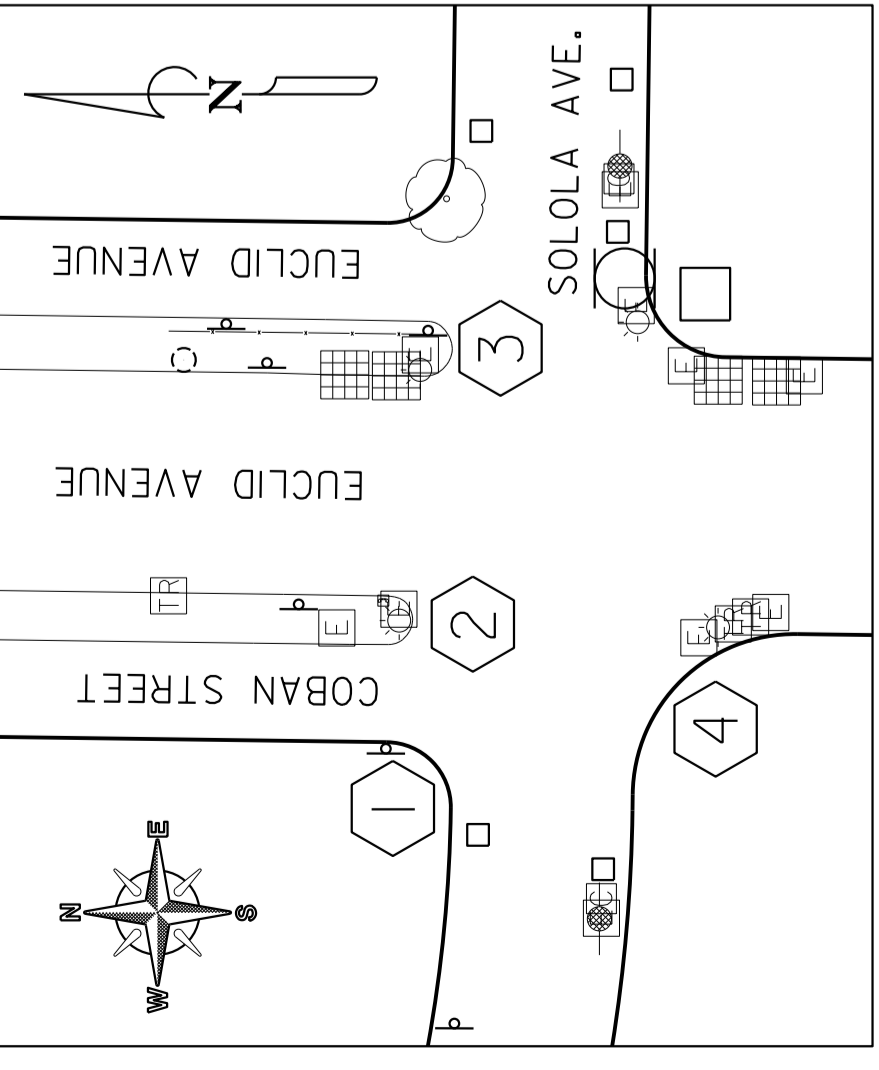

LEGEND

- (8) CURB RAMP NO.'s
- 124.74 EXISTING ELEVATION
- 124.74 PROPOSED ELEVATION
- NEW PCC CONCRETE
- ASPHALT PAVING PER SDG-113
- DIRECTION OF DRAINAGE FLOW
- SLOPE TRANSITION LINE

STANDARD DRAWING
GENERAL CURB RAMP NOTES & SUPPLEMENTAL DETAILS
TYPE A & B
TYPE C1
TYPE C2
TYPE D
EX STAMP/IMPRESSION PLACEMENT
CROSS GUTTER

SDG-130
SDG-132
SDG-134
SDG-135
SDG-136
SDG-115
SDG-157

SOLOLA & EUCLID CURB RAMP NOTES & ISLAND PASSAGEWAYS

C-1

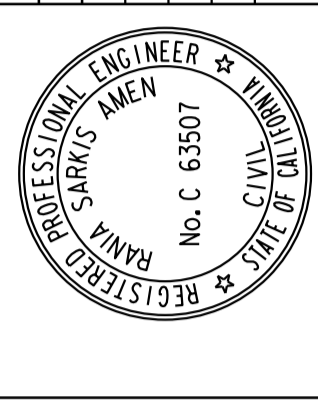
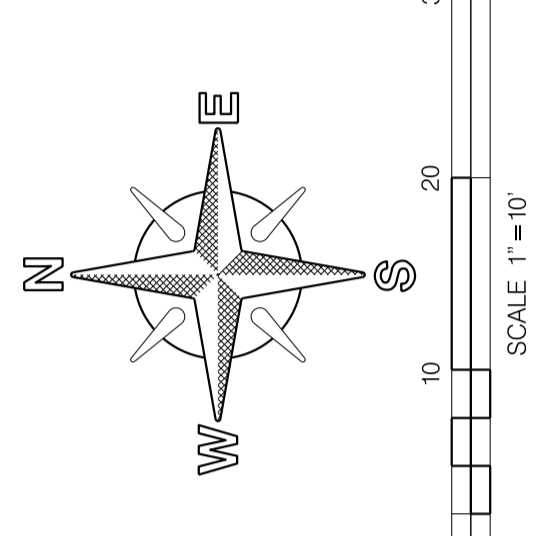

CITY OF SAN DIEGO, CALIFORNIA
PUBLIC WORKS DEPARTMENT
SHEET 3 OF 5 SHEETS
DATE 8/25/14

FOR CITY ENGINEER: SARAH CHAVEZ, PROJECT MANAGER
FOR PROJECT ENGINEER: CECILIA MARISTELA

DESIGNER: RAIN SARKS AMEN
BY: ORIGINAL
DATE: 8/25/14
FILED: 8/25/14

WBS: B-13069
PROJECT NO.: 180-1744
PROJECT ENGINEER: CECILIA MARISTELA
COORDINATOR: 1830444-6304407
CONTRACTOR: 37724-03-D

CURB RAMP NOTES TABLE

LOCATION	CURB RAMP		REPLACEMENT	HISTORIC STAMPS	SURVEY MARKER	ST. SIGN	COMMENTS / MODIFICATIONS
	TYPE	CASE					
1	C2		X	X	X	X	EXTEND MEDIAN & INSTALL MODIFIED PASSAGEWAY
2			X	X	X	X	INSTALL MODIFIED PASSAGEWAY
3			X	X	X	X	
4	A		X	X	X	X	

- NOTES**
- PROTECT EXISTING WATER METER/UTILITY AND ELECTRICAL BOX AND ADJUST TO GRADE.
 - HISTORIC STAMPS TO BE SAVED AND REINSTALLED PER SDG15.
 - MODIFIED CURB RAMP CAN BE EXTENDED UP TO MAXIMUM OF 15 LINEAR FEET TO CATCH THE REQUIRED SLOPE OR REPLACE THE DAMAGED SIDEWALK.
 - THE DETECTABLE WARNING TILES SHALL BE COMPOSITE PER THE CITY'S APPROVED MATERIALS LIST.
 - CONTRACTOR TO NOTIFY THE SURVEY DIVISION 7 DAYS PRIOR TO REMOVAL OF SIDEWALK FOR CURB RAMP CONSTRUCTION TO TIE OUT ANY SURVEY MARKERS.

SOLOLA AVE SIDEWALK IMPROVEMENT PLAN

POLE							SCHEDULE				
No.	TYPE	STANDARD HGT.	SIG. M.A.	LUM. M.A.	PLACEMENT		SIGNAL MOUNTING	VEHICLE	SIGNAL	PEDESTRIAN	REMARKS
					A	B					
1	17-H-70	30'	20'	12'	85W	-	-	SV-2-TB	SP-2-T	4P	REUSE 1 12" HEAD
2	PPB	4'	-	-	-	-	-	-	-	6P	-
3	PPB	4'	-	-	-	-	-	-	-	6P	-
4	17-H-70	30'	20'	12'	85W	-	-	SV-2-TB	SP-2-T	8P	EXISTING SV-2
5	17-H-70	30'	18'	12'	85W	-	-	SV-2-TB	SP-1-T	8P	REUSE 1 12" HEAD
6	I-A	7'	-	-	-	-	-	-	TP-H-T	2P	-
7	17-H-70	30'	18'	12'	85W	-	-	SV-2-TB	SP-2-T	2P, 4P	EXISTING SV-2

NOTES: * UPGRADE ALL PUSH BUTTONS TO ADA STANDARD 2" ACTUATOR.

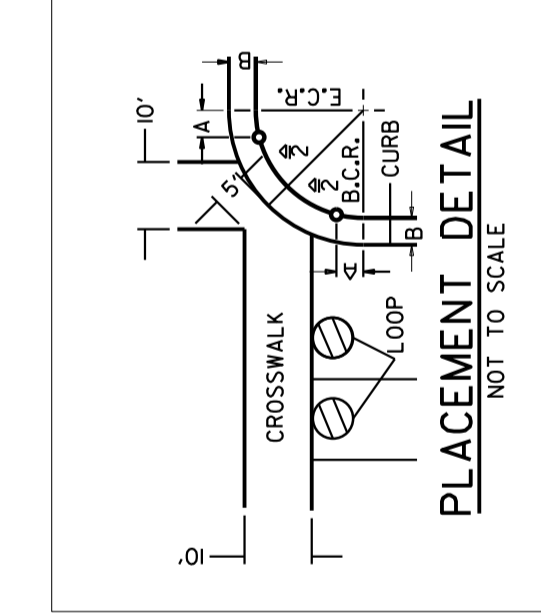
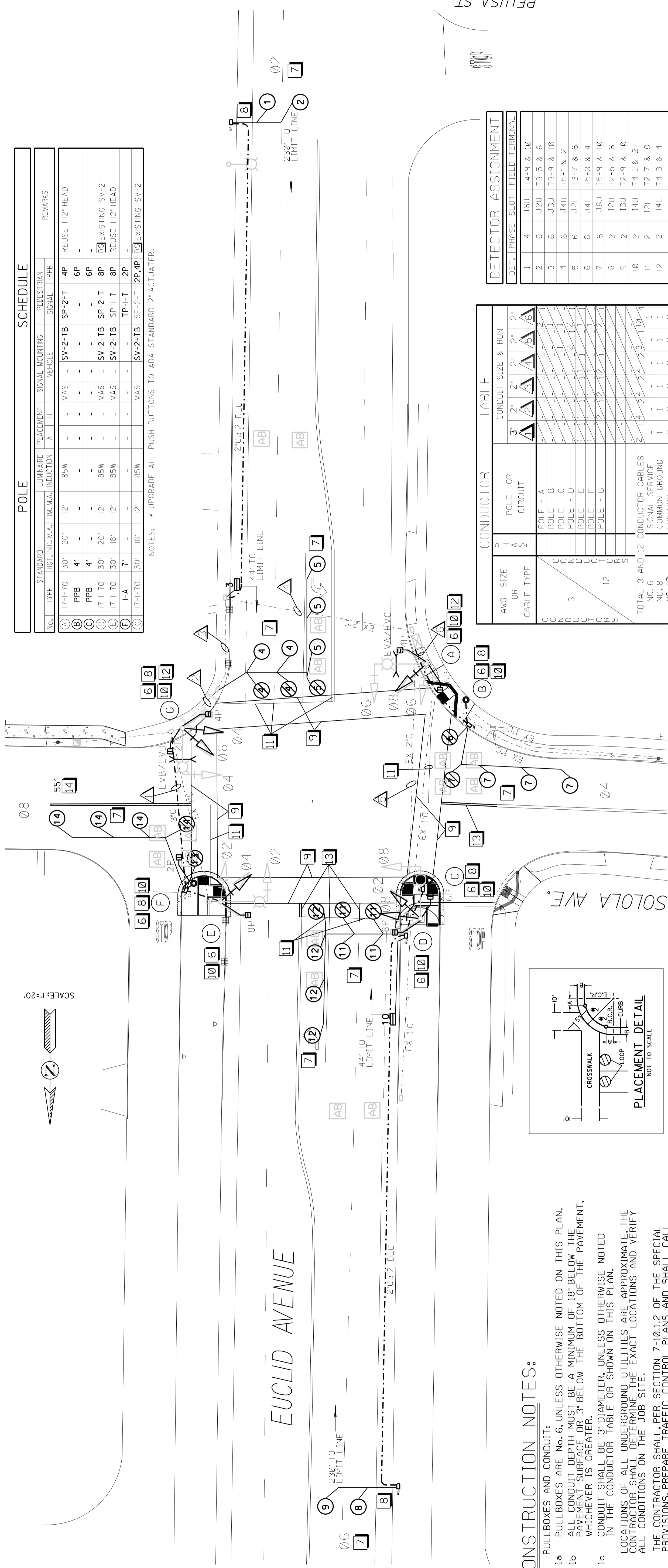

CONSTRUCTION NOTES:

1. PULLBOXES AND CONDUIT:
 - 1a PULLBOXES ARE NO. 6, UNLESS OTHERWISE NOTED ON THIS PLAN.
 - 1b ALL CONDUIT DEPTH MUST BE A MINIMUM OF 18" BELOW THE PAVEMENT SURFACE OR 3" BELOW THE BOTTOM OF THE PAVEMENT, WHICHEVER IS GREATER.
 - 1c CONDUIT SHALL BE 3" DIAMETER, UNLESS OTHERWISE NOTED IN THE CONDUCTOR TABLE OR SHOWN ON THIS PLAN.
2. LOCATIONS OF ALL UNDERGROUND UTILITIES ARE APPROXIMATE. THE CONTRACTOR SHALL DETERMINE THE EXACT LOCATIONS AND VERIFY ALL CONDITIONS ON THE JOB SITE.
3. THE CONTRACTOR SHALL PER SECTION 7-10.1.2 OF THE SPECIAL PROVISIONS, PREPARE TRAFFIC CONTROL PLANS AND SHALL CALL THE FIELD ENGINEERING TRAFFIC CONTROL SECTION, AT (858) 495-4741, FOR AN APPOINTMENT TO APPLY FOR A TRAFFIC CONTROL PLAN (TCP) PERMIT. THE CONTRACTOR SHALL ALLOW A MINIMUM OF TWO (2) WORKING DAYS PRIOR TO STARTING WORK (FIVE (5) WORKING DAYS FOR STREET CLOSURES). UPON APPROVAL OF THE TRAFFIC CONTROL PLAN, THE FIELD ENGINEERING TRAFFIC CONTROL SECTION WILL ISSUE THE TCP PERMIT. WORK SHALL NOT BEGIN IN THE PUBLIC ROADWAY WITHOUT THE TCP PERMIT.
4. ALL TRAFFIC SIGNAL POLE FOUNDATIONS SHALL HAVE A 3" CONDUIT INSTALLED TO AN ADJACENT NO. 6 PULLBOX. THE CONTROLLER FOUNDATION SHALL HAVE A SPARE 3" CONDUIT STUBBED OUT TO THE ADJACENT PULL BOX FOR FUTURE USE.
5. LOCATION, POSITIONING, AND INSTALLATION OF SIGNAL EQUIPMENT, LOOP DETECTORS, TRAFFIC SIGNS, TRAFFIC STRIPING, PAVEMENT AND CURB MARKINGS:
 - 5a THE CONTRACTOR WITH THE APPROVAL OF THE CITY RESIDENT ENGINEER IS RESPONSIBLE FOR LOCATING, MARKING THE LAYOUT, AND INSTALLATION OF ALL SIGNAL AND LIGHTING EQUIPMENT.
 - 5b THE CONTRACTOR, WITH THE APPROVAL OF THE CITY'S DESIGNATED TRAFFIC ENGINEER, IS RESPONSIBLE FOR LOCATING, MARKING THE LAYOUT, AND INSTALLATION OF ALL LOOP DETECTORS, TRAFFIC SIGNS (EXCEPT "G" SERIES STREET NAME SIGNS), TRAFFIC STRIPING, PAVEMENT AND CURB MARKINGS.
 - 5c THE CONTRACTOR SHALL OBTAIN THE APPROVALS FOR THE ITEMS NOTED IN 5a AND 5b PRIOR TO INSTALLATION.
 - 5d AS SHOWN ON THIS PLAN, CONTRACTOR SHALL INSTALL 6" DIAMETER LOOP DETECTORS WITH 10" SPACING AND CENTERED IN THE TRAVEL PORTION OF EACH LANE (UNLESS OTHERWISE NOTED).
 - 5e THE CONTRACTOR SHALL NOT PERFORM ANY PARKING REMOVAL LESS THAN 15 WORKING DAYS AFTER LOCATION APPROVAL.
 - 5f THE CONTRACTOR IS RESPONSIBLE FOR THE REMOVAL OF ALL SANDBLASTING/GRINDING AND PAVEMENT MARKINGS BY THE CITY RESIDENT ENGINEER.

DETECTOR ASSIGNMENT		
DEL. #	PHASE	FIELD TERMINAL
1	4	16U T4-9 & 10
2	6	J2U T3-5 & 6
3	6	J3U T3-9 & 10
4	6	J4U T5-1 & 2
5	6	J2L T3-7 & 8
6	6	J4L T5-3 & 4
7	8	J6U T5-9 & 10
8	2	J2U T2-5 & 6
9	2	J3U T2-9 & 10
10	2	J4U T4-1 & 2
11	2	J2L T2-7 & 8
12	2	J4L T4-3 & 4
PPB	4	I12U T8-4 & COM 6
PPB	6	I13U T8-7 & COM 9
PPB	8	I13L T8-8 & COM 9
EVA	2	J12U T9-4 & COM 6
EVB	4	J13U T9-7 & COM 9
EVC	6	J12L T9-5 & COM 6
EVD	8	J13L T9-8 & COM 9
FLASH	-	I14U T8-10 & COM 12

CONDUCTOR		CONDUIT SIZE & RUN											
AWG OR CABLE TYPE	POLE OR CIRCUIT	3"	2"	2"	2"	2"	2"	2"	2"	2"	2"	2"	2"
CONDUCTORS	POLE - A	1	1	1	1	1	1	1	1	1	1	1	1
CONDUCTORS	POLE - B	1	1	1	1	1	1	1	1	1	1	1	1
CONDUCTORS	POLE - C	1	1	1	1	1	1	1	1	1	1	1	1
CONDUCTORS	POLE - D	1	1	1	1	1	1	1	1	1	1	1	1
CONDUCTORS	POLE - E	1	1	1	1	1	1	1	1	1	1	1	1
CONDUCTORS	POLE - F	1	1	1	1	1	1	1	1	1	1	1	1
CONDUCTORS	POLE - G	1	1	1	1	1	1	1	1	1	1	1	1
TOTAL 3 AND 12 CONDUCTOR CABLES		2	4	2	4	2	4	2	4	2	4	2	4
NO. 6 SIGNAL SERVICE		1	1	1	1	1	1	1	1	1	1	1	1
NO. 8 LIGHTING		2	2	2	2	2	2	2	2	2	2	2	2
NO. 10 LIGHTING		2	2	2	2	2	2	2	2	2	2	2	2
6 PAIR NO. 22 INTERCONNECT CABLE		-	-	-	-	-	-	-	-	-	-	-	-
2 LOOP DETECTOR		-	-	-	-	-	-	-	-	-	-	-	-
TYPE		4	4	4	4	4	4	4	4	4	4	4	4
'B'		6	6	6	6	6	6	6	6	6	6	6	6
'DLC'		8	8	8	8	8	8	8	8	8	8	8	8
EMERGENCY VEHICLE DETECTOR (EV-DLC)		1	1	1	1	1	1	1	1	1	1	1	1
TOTAL CABLES AND CONDUCTORS		9	12	14	17	12	33						

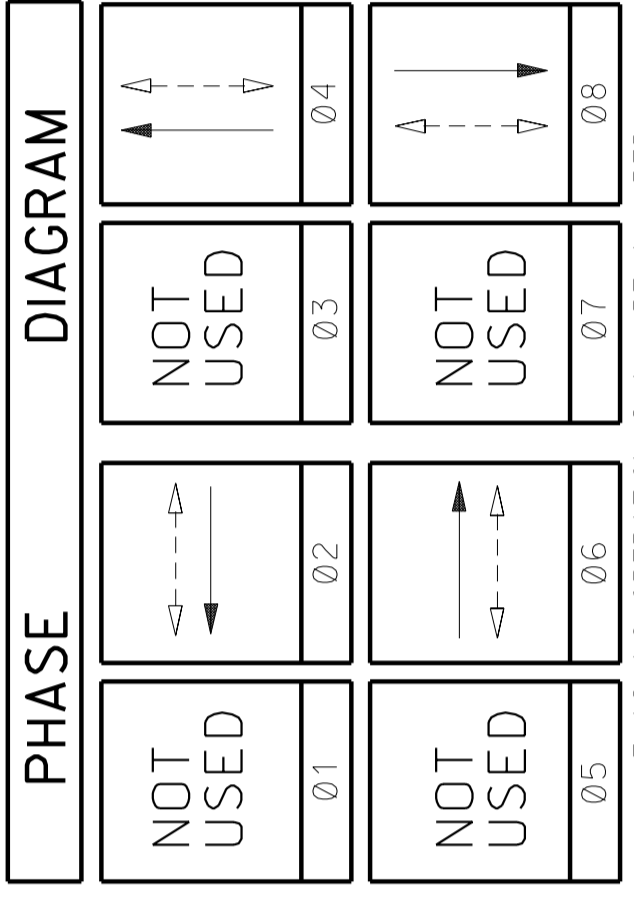

FOR REDUCED PLANS ORIGINAL 0 20' 40' 60'
SCALE IS IN INCHES

 DATE 8/25/14
EUCLID AVE @ SOLOLA AVE
TRAFFIC SIGNAL MODIFICATION

T-1

CITY OF SAN DIEGO, CALIFORNIA
 PUBLIC WORKS DEPARTMENT
 SHEET 5 OF 5 SHEETS
 DATE 8/25/14
 SUBMITTED BY SARAH CHAVEZ
 PROJECT MANAGER
 CHECKED BY CECILIA MARISTELA
 PROJECT ENGINEER
 190-1744
 CDS#7 COORDINATE
 WBS B-13069
 1830444-6304407
 CDS#8 COORDINATE
 37724-5-D

