

Appendix B Excel Datasheets

Summary Section for Off-gas Analysis

May 13-14, 2004, San Diego BAFs

Mole Fract (O2) 0.2095 Hood Area (ft2) N/A
 Mole Ratio (O2/inerts) 0.2650 Actual Bar Pres (in hg) 29.92
 Ref Barom Pres (in hg) 29.92
 Theta 1.024

Air Temp (for SCFM Calc, o C) 75 50 % of depth
 Tank SWD (ft) 20 3.25 PSI
 Diffuser Sub (ft) 15 1.221088 dE
 Rotocalibration (mm) 0 11.07527 C* inf

Test No.	Air flow (SCFM)	H2O Flow (GPM)	Column	Ref Vol (volts)	Off-G Vol (volts)	H2O Temp (deg C)	DO (mg/L)	CO2 (%)	Beta	Off-gas Temp (deg F)	Rota 1 Reading (small)	Rota 2 Reading (big)	Roto Temp Correction	M Fraction Off-gas	M Ratio Off-gas	OTE (%)	C* inf T (mg/L)	aSOTE (%)	C* inf 20 (mg/L)	Alpha	SOTE (%)	P Corr (ratio)	Abs T (deg K)	Roto Total Gas Flow (scfm)	Roto1 (scfm)	Roto2 (scfm)
1	1.98 5.53	Biofor N	1.011	0.918	26.3	6.18	0.00	0.99	85	5	0	0.99	0.190	0.235	11.36	9.86	30.16	11.07	0.84	36.0	1.2192	299.3	0.2	0.2	0.0	
1	1.98 5.53	Biofor N	1.011	0.916	26.3	6.18	0.00	0.99	70	5	0	1.00	0.190	0.234	11.60	9.86	30.79	11.07	0.86	36.0	1.2192	299.3	0.2	0.2	0.0	
1	1.98 5.53	Biofor N	1.011	0.914	26.3	6.18	0.00	0.99	78	5	0	0.99	0.189	0.234	11.84	9.86	31.42	11.07	0.87	36.0	1.2192	299.3	0.2	0.2	0.0	
2	2.11 5.45	Biofor N	1.007	0.911	27.4	6.15	0.00	0.99	77	5	0	0.99	0.190	0.234	11.76	9.67	31.90	11.07	0.89	36.0	1.2192	300.4	0.2	0.2	0.0	
2	2.11 5.45	Biofor N	1.000	0.909	27.4	6.15	0.00	0.99	77	5	0	0.99	0.190	0.235	11.24	9.67	30.48	11.07	0.85	36.0	1.2192	300.4	0.2	0.2	0.0	
2	2.11 5.45	Biofor N	0.998	0.898	27.4	6.15	0.00	0.99	77	5	0	0.99	0.189	0.232	12.35	9.67	33.49	11.07	0.93	36.0	1.2192	300.4	0.2	0.2	0.0	
2	2.11 5.45	Biofor N	0.992	0.888	27.4	6.15	0.00	0.99	80	5	0	0.99	0.188	0.231	12.90	9.67	35.00	11.07	0.97	36.0	1.2192	300.4	0.2	0.2	0.0	
3	2.11 6.13	Biofor N	1.008	0.851	24.5	4.88	0.00	0.99	80	5	0	0.99	0.177	0.215	18.92	10.20	36.07	11.07	1.00	36.0	1.2192	297.5	0.2	0.2	0.0	
3	2.11 6.13	Biofor N	1.005	0.846	24.5	4.88	0.00	0.99	80	5	0	0.99	0.176	0.214	19.21	10.20	36.62	11.07	1.02	36.0	1.2192	297.5	0.2	0.2	0.0	
3	2.11 6.13	Biofor N	1.001	0.863	24.5	4.88	0.00	0.99	80	5	0	0.99	0.181	0.220	16.83	10.20	32.07	11.07	0.89	36.0	1.2192	297.5	0.2	0.2	0.0	
3	2.11 6.13	Biofor N	1.000	0.860	24.5	4.88	0.00	0.99	80	5	0	0.99	0.180	0.220	17.08	10.20	32.55	11.07	0.90	36.0	1.2192	297.5	0.2	0.2	0.0	
3	2.11 6.13	Biofor N	1.010	0.854	24.5	4.88	0.00	0.99	80	5	0	0.99	0.177	0.215	18.77	10.20	35.78	11.07	0.99	36.0	1.2192	297.5	0.2	0.2	0.0	
4	1.22 4.88	Biofor N	1.028	0.827	25.9	4.25	0.00	0.99	80	5	0	0.99	0.169	0.203	23.52	9.94	40.51	11.07	1.13	36.0	1.2192	298.9	0.2	0.2	0.0	
4	1.22 4.88	Biofor N	1.023	0.826	25.9	4.25	0.00	0.99	80	5	0	0.99	0.169	0.204	23.18	9.94	39.92	11.07	1.11	36.0	1.2192	298.9	0.2	0.2	0.0	
4	1.22 4.88	Biofor N	1.028	0.830	25.9	4.25	0.00	0.99	80	5	0	0.99	0.169	0.204	23.18	9.94	39.93	11.07	1.11	36.0	1.2192	298.9	0.2	0.2	0.0	
4	1.22 4.88	Biofor N	1.030	0.837	25.9	4.25	0.00	0.99	80	5	0	0.99	0.170	0.205	22.58	9.94	38.90	11.07	1.08	36.0	1.2192	298.9	0.2	0.2	0.0	
5	0.8 4.85	Biofor N	1.016	0.891	25.9	5.38	0.00	0.99	80	5	0	0.99	0.184	0.225	15.07	9.94	32.51	11.07	0.90	36.0	1.2192	298.9	0.2	0.2	0.0	
5	0.8 4.85	Biofor N	1.014	0.876	25.9	5.38	0.00	0.99	80	5	0	0.99	0.181	0.221	16.62	9.94	35.84	11.07	1.00	36.0	1.2192	298.9	0.2	0.2	0.0	
5	0.8 4.85	Biofor N	1.013	0.906	25.9	5.38	0.00	0.99	80	5	0	0.99	0.187	0.231	13.00	9.94	28.03	11.07	0.78	36.0	1.2192	298.9	0.2	0.2	0.0	
5	0.8 4.85	Biofor N	1.014	0.888	25.9	5.38	0.00	0.99	80	5	0	0.99	0.183	0.225	15.22	9.94	32.82	11.07	0.91	36.0	1.2192	298.9	0.2	0.2	0.0	
6	2.07 5.40	Biofor N	1.024	0.909	25.9	5.53	0.00	0.99	80	5	0	0.99	0.186	0.228	13.80	9.94	30.79	11.07	0.86	36.0	1.2192	298.9	0.2	0.2	0.0	
6	2.07 5.40	Biofor N	1.023	0.898	25.9	5.53	0.00	0.99	80	5	0	0.99	0.184	0.225	14.97	9.94	33.41	11.07	0.93	36.0	1.2192	298.9	0.2	0.2	0.0	
6	2.07 5.40	Biofor N	1.020	0.898	25.9	5.53	0.00	0.99	80	5	0	0.99	0.184	0.226	14.67	9.94	32.73	11.07	0.91	36.0	1.2192	298.9	0.2	0.2	0.0	
6	2.07 5.40	Biofor N	1.018	0.888	25.9	5.53	0.00	0.99	80	5	0	0.99	0.183	0.224	15.63	9.94	34.87	11.07	0.97	36.0	1.2192	298.9	0.2	0.2	0.0	
6	2.07 5.40	Biofor N	1.018	0.892	25.9	5.53	0.00	0.99	80	5	0	0.99	0.184	0.225	15.16	9.94	33.83	11.07	0.94	36.0	1.2192	298.9	0.2	0.2	0.0	
1	1.43 6.05	Biofor C	1.011	0.955	26.8	4.58	0.00	0.99	78	5	0	0.99	0.198	0.247	6.91	9.78	12.75	11.07	0.35	36.0	1.2192	299.8	0.2	0.2	0.0	
1	1.43 6.05	Biofor C	1.011	0.956	26.8	4.58	0.00	0.99	80	5	0	0.99	0.198	0.247	6.78	9.78	12.52	11.07	0.35	36.0	1.2192	299.8	0.2	0.2	0.0	
1	1.43 6.05	Biofor C	1.011	0.959	26.8	4.58	0.00	0.99	78	5	0	0.99	0.199	0.248	6.42	9.78	11.85	11.07	0.33	36.0	1.2192	299.8	0.2	0.2	0.0	
1	1.43 6.05	Biofor C	1.011	0.958	26.8	4.58	0.00	0.99	77	5	0	0.99	0.199	0.248	6.54	9.78	12.07	11.07	0.34	36.0	1.2192	299.8	0.2	0.2	0.0	
2	1.4 7.06	Biofor C	0.993	0.926	26.8	4.65	0.00	0.99	80	5	0	0.99	0.195	0.243	8.39	9.78	15.71	11.07	0.44	36.0	1.2192	299.8	0.2	0.2	0.0	
2	1.4 7.06	Biofor C	0.995	0.939	26.8	4.65	0.00	0.99	80	5	0	0.99	0.198	0.246	7.02	9.78	13.14	11.07	0.37	36.0	1.2192	299.8	0.2	0.2	0.0	
2	1.4 7.06	Biofor C	0.996	0.941	26.8	4.65	0.00	0.99	80	5	0	0.99	0.198	0.247	6.88	9.78	12.90	11.07	0.36	36.0	1.2192	299.8	0.2	0.2	0.0	
2	1.4 7.06	Biofor C	0.996	0.926	26.8	4.65	0.00	0.99	80	5	0	0.99	0.195	0.242	8.73	9.78	16.35	11.07	0.45	36.0	1.2192	299.8	0.2	0.2	0.0	

3	1.35	6.24	Biofor C	1.016	0.887	27.1	3.48	0.00	0.99	80	5	0	0.99	0.183	0.224	15.54	9.72	23.63	11.07	0.66	36.0	1.2192	300.1	0.2	0.2	0.0
3	1.35	6.24	Biofor C	1.019	0.892	27.1	3.48	0.00	0.99	80	5	0	0.99	0.183	0.225	15.26	9.72	23.21	11.07	0.64	36.0	1.2192	300.1	0.2	0.2	0.0
3	1.35	6.24	Biofor C	1.017	0.894	27.1	3.48	0.00	0.99	80	5	0	0.99	0.184	0.226	14.82	9.72	22.54	11.07	0.63	36.0	1.2192	300.1	0.2	0.2	0.0
3	1.35	6.24	Biofor C	1.016	0.892	27.1	3.48	0.00	0.99	80	5	0	0.99	0.184	0.225	14.96	9.72	22.74	11.07	0.63	36.0	1.2192	300.1	0.2	0.2	0.0
4	2.5	6.24	Biofor C	1.017	0.892	27.1	5.30	0.00	0.99	80	5	0	0.99	0.184	0.225	15.06	9.72	32.56	11.07	0.90	36.0	1.2192	300.1	0.2	0.2	0.0
4	2.5	6.24	Biofor C	1.021	0.885	27.1	5.30	0.00	0.99	80	5	0	0.99	0.182	0.222	16.28	9.72	35.19	11.07	0.98	36.0	1.2192	300.1	0.2	0.2	0.0
4	2.5	6.24	Biofor C	1.021	0.887	27.1	5.30	0.00	0.99	80	5	0	0.99	0.182	0.223	16.04	9.72	34.69	11.07	0.96	36.0	1.2192	300.1	0.2	0.2	0.0
4	2.5	6.24	Biofor C	1.018	0.893	27.1	5.30	0.00	0.99	80	5	0	0.99	0.184	0.225	15.04	9.72	32.53	11.07	0.90	36.0	1.2192	300.1	0.2	0.2	0.0
1	2.0	7.5	BioStyr	0.956	0.904	26.0	5.40	0.00	0.99	80	5	0	0.99	0.198	0.247	6.78	9.92	14.74	11.07	0.41	36.0	1.2192	299.0	0.2	0.2	0.0
1	2.0	7.5	BioStyr	0.953	0.892	26.0	5.40	0.00	0.99	80	5	0	0.99	0.196	0.244	7.96	9.92	17.30	11.07	0.48	36.0	1.2192	299.0	0.2	0.2	0.0
1	2.0	7.5	BioStyr	0.951	0.898	26.0	5.40	0.00	0.99	80	5	0	0.99	0.198	0.247	6.95	9.92	15.09	11.07	0.42	36.0	1.2192	299.0	0.2	0.2	0.0
1	2.0	7.5	BioStyr	0.949	0.897	26.0	5.40	0.00	0.99	80	5	0	0.99	0.198	0.247	6.83	9.92	14.84	11.07	0.41	36.0	1.2192	299.0	0.2	0.2	0.0
2	2.0	7.5	BioStyr	1.000	0.955	26.0	5.53	0.00	0.99	80	5	0	0.99	0.200	0.250	5.63	9.92	12.58	11.07	0.35	36.0	1.2192	299.0	0.2	0.2	0.0
2	2.0	7.5	BioStyr	1.003	0.958	26.0	5.53	0.00	0.99	80	5	0	0.99	0.200	0.250	5.61	9.92	12.54	11.07	0.35	36.0	1.2192	299.0	0.2	0.2	0.0
2	2.0	7.5	BioStyr	1.005	0.963	26.0	5.53	0.00	0.99	80	5	0	0.99	0.201	0.251	5.23	9.92	11.69	11.07	0.32	36.0	1.2192	299.0	0.2	0.2	0.0
2	2.0	7.5	BioStyr	1.007	0.963	26.0	5.53	0.00	0.99	80	5	0	0.99	0.200	0.251	5.46	9.92	12.22	11.07	0.34	36.0	1.2192	299.0	0.2	0.2	0.0
2	2.0	7.5	BioStyr	1.013	0.963	26.0	5.53	0.00	0.99	80	5	0	0.99	0.199	0.249	6.16	9.92	13.78	11.07	0.38	36.0	1.2192	299.0	0.2	0.2	0.0
3	1.0	7.5	BioStyr	1.026	0.985	26.2	4.55	0.00	0.99	80	5	0	0.99	0.201	0.252	5.00	9.88	9.13	11.07	0.25	36.0	1.2192	299.2	0.2	0.2	0.0
3	1.0	7.5	BioStyr	1.026	0.985	26.2	4.55	0.00	0.99	80	5	0	0.99	0.201	0.252	5.00	9.88	9.13	11.07	0.25	36.0	1.2192	299.2	0.2	0.2	0.0
3	1.0	7.5	BioStyr	1.026	0.987	26.2	4.55	0.00	0.99	80	5	0	0.99	0.202	0.252	4.76	9.88	8.69	11.07	0.24	36.0	1.2192	299.2	0.2	0.2	0.0
3	1.0	7.5	BioStyr	1.026	0.986	26.2	4.55	0.00	0.99	80	5	0	0.99	0.202	0.252	4.76	9.88	8.69	11.07	0.24	36.0	1.2192	299.2	0.2	0.2	0.0
4	3.0	7.5	BioStyr	1.021	0.963	26.6	5.80	0.00	0.99	80	5	0	0.99	0.201	0.252	4.88	9.81	11.81	11.07	0.33	36.0	1.2192	299.6	0.2	0.2	0.0
4	3.0	7.5	BioStyr	1.020	0.957	26.6	5.80	0.00	0.99	80	5	0	0.99	0.198	0.246	7.08	9.81	17.12	11.07	0.48	36.0	1.2192	299.6	0.2	0.2	0.0
4	3.0	7.5	BioStyr	1.019	0.962	26.6	5.80	0.00	0.99	80	5	0	0.99	0.197	0.245	7.69	9.81	18.60	11.07	0.52	36.0	1.2192	299.6	0.2	0.2	0.0
4	3.0	7.5	BioStyr	1.018	0.958	26.6	5.80	0.00	0.99	80	5	0	0.99	0.198	0.247	6.97	9.81	16.87	11.07	0.47	36.0	1.2192	299.6	0.2	0.2	0.0
5	2.0	5	BioStyr	1.018	0.950	26.8	5.98	0.00	0.99	80	5	0	0.99	0.197	0.246	7.34	9.78	18.68	11.07	0.52	36.0	1.2192	299.8	0.2	0.2	0.0
5	2.0	5	BioStyr	1.020	0.968	26.8	5.98	0.00	0.99	80	5	0	0.99	0.196	0.243	8.30	9.78	21.12	11.07	0.59	36.0	1.2192	299.8	0.2	0.2	0.0
5	2.0	5	BioStyr	1.021	0.951	26.8	5.98	0.00	0.99	80	5	0	0.99	0.199	0.248	6.36	9.78	16.19	11.07	0.45	36.0	1.2192	299.8	0.2	0.2	0.0
5	2.0	5	BioStyr	1.019	0.946	26.8	5.98	0.00	0.99	80	5	0	0.99	0.195	0.242	8.52	9.78	21.67	11.07	0.60	36.0	1.2192	299.8	0.2	0.2	0.0

Averages and ranges

	H2O Q (GPM)	Air Q (SCFM)	OTE avg (%)	OTE sd (%)	aSOTE avg (%)	aSOTE sd (%)	Air/Liquid	Liquid/Air
Biofor N 1	5.53	1.98	11.6	0.24	30.8	0.63	2.99	0.33
Biofor N 2	5.45	2.11	12.1	0.7	32.7	2.0	3.23	0.31
Biofor N 3	6.13	2.11	18.2	1.1	34.6	2.1	2.87	0.35
Biofor N 4	4.88	1.22	23.1	0.4	39.8	0.7	2.09	0.48
Biofor N 5	4.85	0.8	15.0	1.5	32.3	3.2	1.38	0.73
Biofor N 6	5.4	2.07	14.8	0.7	33.1	1.5	3.20	0.31
Biofor C 1	6.05	1.43	6.7	0.2	12.3	0.4	1.97	0.51
Biofor C 2	7.06	1.4	7.8	0.9	14.5	1.8	1.65	0.60
Biofor C 3	6.24	1.35	15.1	0.3	23.0	0.5	1.80	0.55
Biofor C 4	6.24	2.5	15.6	0.6	33.7	1.4	3.34	0.30
BioStyr 1	7.5	2.0	7.1	0.6	15.5	1.2	2.22	0.45
BioStyr 2	7.5	2.0	5.6	0.3	12.6	0.3	2.22	0.45
BioStyr 3	7.5	1.0	4.9	0.1	8.9	0.3	1.11	0.90
BioStyr 4	7.5	3.0	6.7	1.2	16.1	3.0	3.34	0.30
BioStyr 5	5.0	2.0	7.6	1.0	19.4	2.5	3.34	0.30

DO data	Biofor C				Biofor N						BioStyr					
	Ports	1	2	3	4.0	1	2	3	4	5	6	1	2	3	4	5
0.833333	4.4	4.5	4.5	5.9	6.3	6.2	5.1	4.9	6.4	5.0	6.0	6.8	7.0	6.9	7.0	
	4	4.8	5.7	3.8	5.1	6.6	6.4	5.8	5.2	5.3	6.5	6.1	6.0	5.2	6.5	7.0
	8	4.9	4.3	2.8	5.2	6.1	6.1	4.5	3.8	5	5.7	5.8	5.6	5	6	6
	12	4.2	4.1	2.8	5.0	5.7	5.9	4.1	3.1	4.8	4.9	3.7	3.7	0.5	3.8	3.9

Appendix C- Photographs
(pictures 1 through the top of 4 provided by H. Melcer, Brown and Caldwell)



Picture 1. Pilot Plants. Top – Looking south, Biostyr on the left, Biofor C and N to the right and in the back. Bottom. Looking north, Biofor N on the left, Biofor C behind (not visible), and Biostyr to the right. Long pipes in the air are siphon breakers.

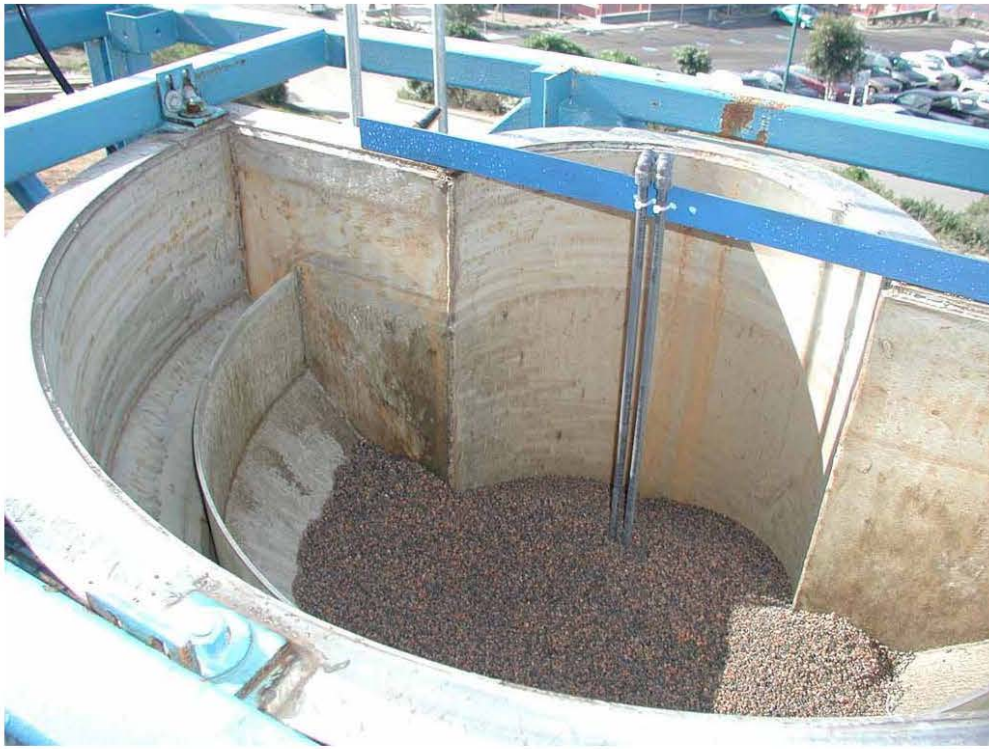

Picture 2. Biofor details. Top. Top structure showing media. Bottom. Top of columns, with Biofor C on the left.



Picture 3. Biostyr. Top. Upper portion of the column. Bottom, backwash compartment, showing nozzles. Hose is being used to charge the column with media.

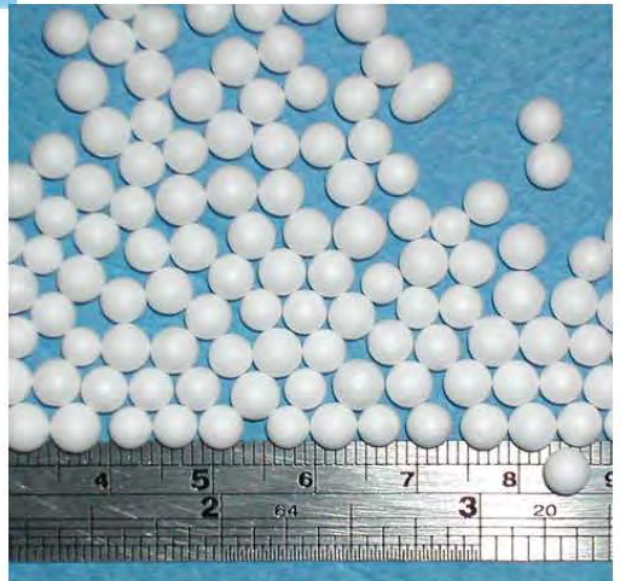

Picture 4. Top. Upper sight glass on the Biostyr, showing media. Picture taken during media loading. Bottom: details of media- reddish brown – Biofor, white Biostyr.

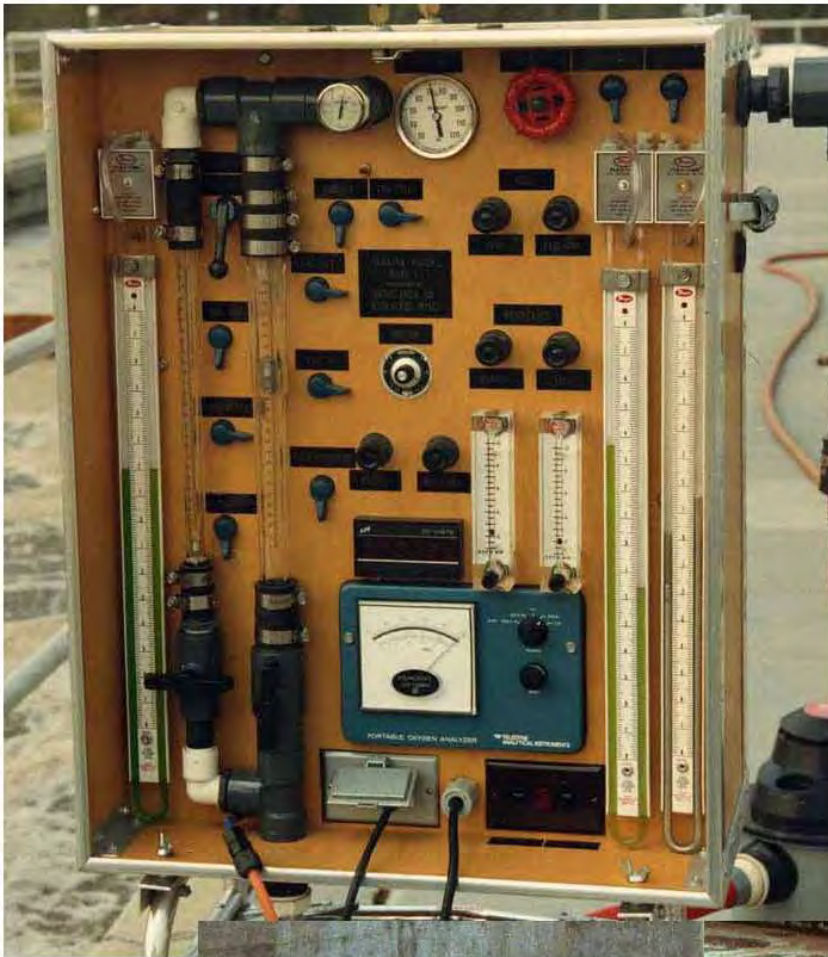

Picture 5. Top Off-gas analyzer. The blue device in the center bottom is the Teledyne 320B analyzer. Bottom – off-gas collection hood typically used for testing activated sludge plants (no hood used during BAF testing).

Report on Oxygen Transfer Testing on Point Loma WWTP
Biological Aerated Filter Pilot Plants

Michael K. Stenstrom
PO. Box 24894
Los Angeles, CA 90024

December 28, 2004
Revised January 13, 2005

TABLE OF CONTENTS		Page
1.	SUMMARY	3
2.	INTRODUCTION	5
	BACKGROUND	5
	SCOPE	5
	TESTING TEAM	5
3.	DESCRIPTION OF APPARATUS	5
4.	TEST PROCEDURE	7
5.	RESULTS AND DISCUSSION	8
	AERATION RESULTS	8
	DOC AND COD RESULTS	9
	MASS BALANCE	9
	OBSERVATIONS AT THE SAMPLING PORTS	10
	Biofor C	10
	Biostyr	10
6.	REFERENCES	11
7.	APPENDIX A - OFF-GAS ANALYSIS TECHNICAL DESCRIPTION	18
8.	APPENDIX B – OFF-GAS DATA SPREADSHEETS	29
9.	APPENDIX C – PHOTOGRAPHS OF THE PILOT PLANTS AND TEST EQUIPMENT.	32

SUMMARY

Oxygen transfer testing of two pilot-scale biological aerated filters (BAFs) was performed at the Point Loma wastewater treatment plant on December 9-10, 2004. The pilot plants were being evaluated as part of a testing program designed to develop alternatives for secondary treatment at the Point Loma plant, should it ever be necessary. The purpose of the testing was to determine the oxygen transfer rates to assist in the overall evaluation of the BAFs.

This report describes the second series of tests. An early test was performed on May 8-9, 2004. During this test, three pilot plants were tested. In the December test, the second Biofor pilot plant (Biofor N) was not being operated. The second series of tests was performed in part because of equipment failures and operational uncertainties that occurred during the first series of tests. These problems were avoided in the second test.

Two of the BAFs were supplied by Infilco Degremont Inc (IDI) and were originally being operated in series. They were designated as Biofor C and Biofor N, with the Biofor C filter functioning as the first BAF in the series configuration. The "C" denotes carbonaceous removal and the "N" denotes nitrification. During the second series of tests, only the Biofor C plant was operating. The third BAF was supplied by Kruger/Veolia and is called Biostyr. It was operated independently of the Biofor units except that it was treating the same influent wastewater.

Testing was scheduled over two days to allow a variety of conditions to be tested. No significant problems occurred with equipment, although a separate meter was used to measure the Biofor C gas flow rate. During the available time, the filters were off-gas tested twice at the design air and liquid flow rates. Additional testing was performed at other air flow rates. Dissolved organic carbon (DOC) and chemical oxygen demand (COD) concentrations were measured at the conclusion of the testing for the influent, effluent and at several heights along the columns. Two duplicate grab samples were collected from the influent and a single grab sample was collected from each port and the effluent. These data along with the routine monitoring data were used to perform a material balance. The off-gas testing protocol was the same as in the earlier test.

The results are summarized in Table 1. The columns in the table indicate the conditions for air and liquid flow, along with average oxygen transfer efficiencies and standard deviation of measurements at the same condition. The OTE is not adjusted for process conditions such as temperature, DO etc. and represents the actual oxygen transfer. The SOTEs are adjusted for process conditions. Generally, SOTEs are used for comparing systems or conditions, but the nature of the BAFs may make this unpractical, because the DO concentration can be high in one part of the column and limiting in another part of the column. This issue is discussed more in the text.

The transfer efficiencies of the columns at the design air flow rates were as good or better as one might expect from a typical fine-pore aeration system treating similar flows at similar depths. The improved transfers are likely due to the bubble hold up time in the media. The Biofor N results, from the first test, ranged from 12 to 23% OTE, which at

the lower air flow rates (1.2 SCFM) are similar to the Biofor C results measured in this test.

The dissolved oxygen (DO) concentration in each column was lowest at the lowest sample point, then increased to a maximum at the next sample point and then decreased gradually with increasing height. This suggests that it takes a short amount of time to aerate the low-DO primary effluent and that the DO decreases due to the oxygen demand in the bed.

The influent DOC concentrations to the columns were 66 to 67 mg/L and the COD was 205 to 210 mg/L. The Biostyr effluent DOC and COD concentrations were 14.3 mg/L and 77 mg/L, respectively. The Biofor C effluent DOC and COD concentrations were 14.3 and 71 mg/L, respectively. The differences in concentrations between the two columns are less than the experimental error of the DOC and COD measuring technique. DOC and COD concentrations, with one exception, declined along the height of the column, as expected.

Liquid and air-side mass balances were performed to see if the gas transfer rates matched the removal of oxygen demand in the BAFs. The gas transfer efficiency is 33 to 53% greater than predicted by the liquid-side balance for the Biostyr column. For the Biofor column, the transfer efficiency is 8% greater to 39% less than predicted by the liquid-side balance.

Table 1. Summary of Oxygen Transfer Test Results

Column	Test No.	Liquid Flow rate (GPM)	Airflow Rate (SCFM)	OTE avg. (%)	OTE stdev (%)	SOTE avg. (%)	SOTE stdev (%)
Biofor C	1	6.2	7.3	5.8	0.2	15.7	0.5
Biofor C	2	6.2	7.3	7.1	0.4	15.4	0.8
Biofor C	3	6.2	2.1	14.8	0.1	28.3	0.1
Biofor C	4	6.2	1.3	21.1	0.8	40.8	1.5
Biostyr	1	7.4	2.0	19.4	0.4	33.3	0.6
Biostyr	2	7.2	2.0	21.9	0.1	39.6	0.3
Biostyr	3	7.4	1.5	26.7	0.2	43.7	0.3
Biostyr	4	7.3	1.5	29.0	0.3	48.9	0.5
Biostyr	5	7.4	3.0	16.9	0.1	26.4	0.1
Biostyr	6	7.4	4	14.1	0.2	23.1	0.1

INTRODUCTION

BACKGROUND

The City of San Diego has operated the Point Loma plant as an advanced primary plant, utilizing chemical precipitation to enhance primary clarification. They have successfully operated with an ocean waiver and expect to continue to do so. Plant and City management are evaluating different processes in the event that additional treatment is required. The site of the Point Loma plant is constrained, and there is insufficient room to build a conventional activated sludge process. The Biological Activated Filter (BAF) process, which uses a media bed as a biological reactor, is being evaluated because of its reduced area requirements. The lack of area at the Point Loma site makes BAFs an attractive alternative to the activated sludge process.

SCOPE

The objective of the testing was to evaluate the oxygen transfer efficiency of two BAF pilot columns. An earlier test was performed on May 13 and 14, and three columns were tested. Two columns (Biofor C and Biofor N) were supplied by IDI and the third column (Biostyr) was supplied by Kruger. The Biofor N column was not operating during the second test. Several conditions for each column were evaluated. The dissolved organic carbon (DOC) and chemical oxygen demand (COD) were measured at the conclusion of the test, and various observations are reported.

TESTING TEAM

Professor Michael K. Stenstrom and Diego Rosso from the Civil Engineering Department at UCLA, acting as private consultants, conducted the testing. The testing was coordinated by Josh Newman of Brown and Caldwell. The pilot plant was being operated by both City of San Diego and Brown and Caldwell in cooperation with the manufacturers of each system. Dr. Hong W. Zhao from Kruger observed the second test on both days, adjusted the Biostyr pilot plant to the various process conditions, but did not participate in the off-gas testing.

DESCRIPTION OF APPARATUS

When performing an off-gas analysis of a typical aeration basin, hoods, approximately 25 ft², are floated on the water and capture rising air bubbles, called off-gas. Multiple hood positions are used and the hoods are placed in representative positions around the aeration tank. Generally 4 to 6% of the surface is sampled (always greater than 2% of the surface, to conform to ASCE-EWRI testing guidelines). The measurements at various hood positions are averaged according to the airflow rate at each position, to produce a flow-weighted average transfer efficiency. Because the BAF columns are small, it is possible to capture all the gas leaving the columns, and a flow-weighted average is not necessary.

Appendix A describes the procedure in greater detail. The procedures were developed during an extensive testing program at multiple locations in the United States, and a three-year study (Stenstrom and Masutani, 1990) involving four Los Angeles area treatment plants helped define the protocols. The projects were jointly sponsored by ASCE and US EPA. The details of the testing for aeration tanks are available (US EPA, 1989).

The object of the experiment setup was to cover the tops of the columns to allow the air that was being passed through the columns to be captured and directed through the analyzer. The analyzer dried the air, removed the carbon dioxide and measured the oxygen mole fraction. A comparison of the mole fraction of the off-gas to air allows the oxygen transfer efficiency to be determined, as discussed in Appendix A.

Figure 1 is a schematic of the pilot plants. The figure is not to scale and shows only the information needed to understand the oxygen transfer tests. The entry and exit points for the various flows are also schematically located and should not be taken literally; manufacturers' drawings should be consulted for exact measurements and locations.

The figure shows only the Biofor C column. The report for the first test shows the series arrangement of the Biofor columns. The air and liquid flows are adjusted manually, and the various valves and pressure gages are not shown. A second blower is used during backwash for both columns. The Biofor C column was being backwashed with its own effluent, which is different than during the first test, when both columns were being backwashed using Biofor N effluent.

The Biostyr column uses a single blower for operation and backwash. Backwash is performed by gravity, by allowing the product water storage tank at the top of the column to drain back through the column. In the case of the pilot plant, the backwash water was supplemented with additional water to better simulate full-scale conditions. The length of the backwash was extended in the period between the first and second off-gas test, and this appears to have improved column performance, which is discussed later.

Black construction plastic was used to cover the top of the columns, as shown in Figure 2. A 1.5-inch diameter hose (e.g., pool cleaning style hose) was used to connect the analyzer to the column headspace. A 3/8-inch manometer hose was connected from under the construction plastic to a 1-inch pressure meter on the analyzer. The pressure meter showed a slightly positive pressure (~ 0.2 inches H₂O column) after the construction plastic sealed the top of the column. The air discharge from the columns, which would normally be released to the atmosphere, was forced through the off-gas analyzer by a vacuum cleaner. The analyzer airflow rate was adjusted to be less than the air flow rate to the column, in order to ensure the headspace had positive air pressure. In this way, there were no leaks of atmospheric air into the column.

TEST PROCEDURE

The test equipment installation began at about 8:30 AM on Thursday, December 9. The Biofor C and Biostyr columns were covered with construction plastic and taped off to restrict air discharge.

Samples for DO concentration were collected from the sample ports during each off-gas test. It is necessary to measure the operating DO concentration in order to fully interpret oxygen transfer rate data. Samples were collected from the ports using a 1000 ml beaker and measured with a YSI Model 58 DO meter and probe. Each port was flushed prior to taking a sample by releasing excess water. No media was released from the Biostyr column since the ports were plumbed through Y strainers. Small amounts of media (10 to 20 particles) were observed in samples the Biofor C column. The average DO concentration of all measurements was used to convert each OTE to SOTE. The amount of solids and color in the samples were noted, and is described later.

On the final day, samples from the ports were collected and analyzed for DOC and COD concentration. The DOC excludes any contribution due to suspended solids in the sample. Generally DOC is more precise and has lower detection limits than either BOD or COD analysis, is usually well correlated to soluble BOD and COD, and is not affected by the ammonia concentration or nitrification.

An inspection of the Biostyr column during the first test suggested uneven distribution of the backwash air. The appearance was different during the second test and the air flow was more evenly distributed. The backwash during the second test produced more bed movement. A blower failed during the first test for the Biofor C column, but there were no blower problems during the second test.

Air and liquid flow rates for the columns are shown in Table 1. The nominal flow rates for the columns during this part of the pilot program were 6 GPM and 1.4 SCFM for Biofor C. The nominal conditions for the Biostyr column were 7.5 GPM and 2.0 SCFM. Table 2 shows other process parameters observed during the tests. It is well known that process operating conditions impact oxygen transfer rate for diffused aeration systems, and one should expect that transfer rates to be impacted in the BAFs by process conditions. Process conditions during the test should always be referenced when comparing tests or treatment systems.

The air flow meter for the Biofor C column failed sometime before the test, and was replaced with an available meter, which was for larger flow rates. As a result, the operating air flow was at the lowest “tick” mark on the air flow meter. Since meters are usually accurate on the basis of percent of full scale, the flow measured by this meter is questionable. A Dwyer rotameter was inserted in the Biofor C air line and was used to measure air flow. The Dwyer meter indicated an air flow of 7.3 SCFM when the process meter indicated less than 3 SCFM. The Dwyer meter was adjusted to standard conditions using the ratio of the square root of the absolute gas pressure to standard pressure ($1 \text{ ATM} = 14.7 \text{ PSI}$), in accordance with Dwyer’s recommendations.

RESULTS AND DISCUSSION

AERATION RESULTS

Table 1 shows the transfer efficiencies for the various process conditions. Figures 3 and 4 show the transfer efficiencies and DO concentrations as a function of column height. They are arranged to show each column on a single page. The DO concentrations were measured at the ports and the height is shown as height above the air feed point. The standard deviations of the OTE and SOTE are also shown as error bars. The bar graph is arranged in chronological order of the test and the numbers above the bars show the liquid flow rate in GPM and airflow rate in SCFM. There is an obvious pattern of increasing aeration efficiency with decreasing gas flow rate, which is expected. In the first test there was no obvious pattern in transfer efficiencies.

The DO concentrations in nearly every case declined with increasing height. It has been speculated that the upper parts of the column might be higher in DO concentration, due to the disappearance of oxygen demand as the liquid rises through the column. This would be analogous to a plug flow activated sludge plant, when the effluent end of the tank rises in DO concentration due to the disappearance of oxygen demand. This situation did not occur in any of the columns, and the DO's were generally lower at the top of the column. The Biostyr effluent is stored above the column for backwashing, and during this storage, the DO may change.

It appears that applying standard conditions for oxygen transfer, as described in the ASCE Standard (1991), may not be appropriate for the BAF process. Generally, when describing an aeration system, it is desirable to convert the results at the operating condition to Standard Conditions (i.e., 0 mg/L DO, 20°C, at 1.0 atm pressure, etc.). This strategy may create errors or unobtainable expectations for BAFs. The DO concentration along the height of the column varies from a high value at the bottom to a lower value at the top. Therefore, normal operation may be at 5 to 6 mg/L in the lower parts of the column. If this were reduced to a lower DO concentration in the hopes of increasing oxygen transfer rates, the upper part of the column may become DO-limited. It is probably safer to use the OTE than SOTE results in comparing processes. If OTE is used it is especially important to be careful to specify process conditions when comparing oxygen transfer results. For example, if the BAF is lightly loaded, having a high air to flow ratio, low transfer efficiency will be observed, even if the system were capable of higher transfer efficiency.

During the first test, the team thought the Biostyr air distribution and backwash was improper. The column surface showed all the air leaving in one place, and the backwash did not appear to agitate the media, as observed from the glass port. The Biostyr results during the first test were well below expectations and there was no trend in OTE with air flow rate. It appears that the initial concerns of the Biostyr's condition were correct. The backwash period was lengthened after the first test (details not available), and the column performance in this test was dramatically better.

DISSOLVED ORGANIC CARBON AND CHEMICAL OXYGEN DEMAND RESULTS

Figures 6 and 7 show the DOC and COD as a function of column height. The influent DOC was 67 mg/L, and the effluent of the Biofor C, shown at approximately 12.5 ft height was 14.3 mg/L. The Biostyr column also had an effluent DOC to 14.3 mg/L. The influent COD was 210 mg/L and was reduced to 71 and 77 mg/L in the Biofor and Biostyr columns.

In both columns, the DOC decreased with increasing height, as expected, with the exception of the point at 1 foot in the Biofor C column. When sampling this point, it was noted that the liquid contained many suspended solids, and it is likely that the higher COD resulted from sloughed biomass from the media. The decrease in DOC and COD with height represents increasing level of treatment.

MASS BALANCE

To determine if the oxygen transfer results were consistent with the oxygen demand being removed from the influent, a mass balance was performed. The basis of this balance is shown in equation 1

$$\text{Oxygen Uptake Rate (OUR)} = \text{COD in} - \text{COD out} - \text{COD converted to cell mass} + Q * ((\text{DO}_{\text{out}} - \text{DO}_{\text{in}}) + 4.55 * (\text{NO}_3\text{-N}_{\text{out}} - \text{NO}_3\text{-N}_{\text{in}})) \quad (1)$$

The oxygen transfer is calculated as follows:

$$\text{Oxygen transfer rate (OTR)} = \text{Air Flow} * \text{weight fraction of oxygen in air} * \text{OTE}/100 \quad (2)$$

The units must be consistent for the equations. For equation (2), a commonly used conversion factor, noted in the ASCE Standard (1991) is 1.036 if air flow is expressed in SCFM, OTE expressed as a fraction, and OTR expressed in pounds per hour.

The fractional conversion of COD to cells is usually called the heterotrophic Yield, and ranges from 0.3 to 0.7 depending on the sludge age of the system and the substrate being treated. In the case of nitrification, the yield represents the fraction of the ammonia that is needed for cell synthesis, and is therefore not oxidized to nitrate. A heterotrophic yield of 0.5 was used for the analysis of the first test, and has been used again here.

Table 3 shows the results of applying these equations for each test for both columns. The oxygen transfer rate in the Biostyr column is greater than the calculated uptake rate. For the Biofor column, the oxygen uptake rate is greater for the low air flow conditions and less for the high air flow conditions. This may result because of changing conditions in the column. Note that the average CODs and nitrate concentrations were used; if they varied from test to test, it would affect the mass balance.

OBSERVATIONS AT THE SAMPLING PORTS.

Biofor C

In the first test there was an easily observable gradient in suspended solids concentration from the bottom port of the column (10 inches above the air injection point) to the top point (12 ft above the air injection point). The sample from the lowest point contained black-colored suspended solids, quite different than MLSS in an activated sludge plant. They appeared similar to iron sulfide flocs, although they did not settle quickly (not so dense). The floc was so concentrated at the 10-inch port that it was not possible to see the bottom of a 1000 mL beaker containing the sample. At the 12 ft port, it was easy to see the bottom of the beaker. The samples had almost no odor.

In the second test, the bottom port contained black-colored suspended solids that had similar properties as before. The concentration was noticeably less than observed in the first test, and the upper ports contained almost no suspended solids.

The lower two ports vented air when sampling during both tests.

Biostyr

The sampling ports on the Biostyr column are piped to shoulder level through a Y strainer and valve, which makes sampling easier for this column. The Biofor columns can only be sampling by climbing the scaffolding to reach the ports. The ports on the Biostyr column required longer flushing to obtain representative samples.

During the first test the lowest sample point on the column routinely vented air when opened, and sampling was not possible at this port. During the second test, the volume of vented air was less, and sampling was possible. The samples were relatively low in suspended solids, and no solids gradient was noted for any of the test conditions.

The media and column surface appeared differently in the second test. In the first test the media was easily observed in the lower port and only a few air bubbles could be seen through the port window. The media did not appear to move during backwashing. Air distribution at the top of the column was uneven, coming almost entirely from a single spot on the surface, near the middle of the column. During the second test, it was more difficult to observe the media, due to slime build-up on the inside of the port. No bubbles were observed during normal operation. During backwashing, it was possible to see media and floc movement through the port. The top of the column also looked different, with much more uniform air distribution.

REFERENCES

ASCE (1991). *ASCE Standard: Measurement of Oxygen Transfer in Clean Water*, ISBN 0-87262-430-7, New York, NY.

Stenstrom, M.K. and Masutani, G., "Fine Pore Diffuser Fouling - the Los Angeles Studies," UCLA Engr. Report No. 90-02, Los Angeles, CA 1990.

US. EPA *Design Manual - Fine Pore Aeration Systems*, Risk Reduction Laboratory, Cincinnati, Ohio, EPA/625/1-89/023, 1989.

Table 1. Summary of Oxygen Transfer Test Results

Column	Test No.	Liquid Flow rate (GPM)	Airflow Rate (SCFM)	OTE avg. (%)	OTE stdev (%)	SOTE avg. (%)	SOTE stdev (%)
Biofor C	1	6.2	7.3	5.8	0.2	15.7	0.5
Biofor C	2	6.2	7.3	7.1	0.4	15.4	0.8
Biofor C	3	6.2	2.1	14.8	0.1	28.3	0.1
Biofor C	4	6.2	1.2	21.1	0.8	40.8	1.5
Biostyr	1	7.4	2.0	19.4	0.4	33.3	0.6
Biostyr	2	7.2	2.0	21.9	0.1	39.6	0.3
Biostyr	3	7.4	1.5	26.7	0.2	43.7	0.3
Biostyr	4	7.3	1.5	29.0	0.3	48.9	0.5
Biostyr	5	7.4	3.0	16.9	0.1	26.4	0.1
Biostyr	6	7.4	4	14.1	0.2	23.1	0.1

Table 2. Process Conditions during the Tests

Parameter (all units in mg/L)	Influent	Biofor C Effluent	Biostyr Effluent
BOD (total)	98	31	21
BOD (carbonaceous)	79	4	12
BOD (soluble)	73	16	7
COD	203	41	67
COD (grab sample)	207	71	76
TKN-N	35	16	31
NH4-N	29	13	26
NO3-N	0.2	12	0.5
TSS	41	9	20
DOC (grab sample)	67	14.3	14.3

Parameters except DOC and the COD grab samples were measured by the San Diego/Brown and Caldwell pilot plant team. The DOC and COD grab samples were measured by the author. Values in some cases are the averages of Dec 8, 9 or 10, since not all process data are collected every day.

Values represent single samples for the various BOD parameters, taken on various days (May 13, 14 or 15), since BOD analyses were not performed every day. COD, NH4-N, TSS and VSS are averages over May 14 and 15. DOC measured in the afternoon of May 15.

Table 3. Mass Balance on COD Compared to Oxygen Transfer Results

Column	Liquid Side								Gas Side			Difference
	Influent Q (GPM)	COD (mg/L)	NO3-N (mg/L)	Effluent COD (mg/L)	NO3-N (mg/L)	DO (mg/L)	Yield	Uptake (g/hr)	Q gas (SCFM)	OTE (%)	OTR (g/hr)	
BioStyr	7.4	210	0.2	77	0.5	4.7	0.50	122	2.0	19.4	183	-33
	7.2	210	0.2	77	0.5	4.7	0.50	119	2.0	21.9	206	-43
	7.4	210	0.2	77	0.5	4.0	0.50	121	1.5	26.7	189	-36
	7.3	210	0.2	77	0.5	1.6	0.50	115	1.5	29.0	205	-44
	7.4	210	0.2	77	0.5	5.0	0.50	122	3.0	16.9	239	-49
	7.4	210	0.2	77	0.5	5.7	0.50	124	4.0	14.1	265	-53
Biofor C	6.2	210	0.2	71	12	5.9	0.50	182	7.3	5.8	197	-8
	6.2	210	0.2	71	12	5.6	0.50	181	7.3	7.1	243	-25
	6.2	210	0.2	71	12	5.5	0.50	181	2.1	14.8	144	26
	6.2	210	0.2	71	12	4.8	0.50	180	1.3	21.1	129	39

Conditions are reported for each test, except for COD. The last values of COD, collected on the second day were used for all tests. See equations 1 and 2 for the calculation procedure.

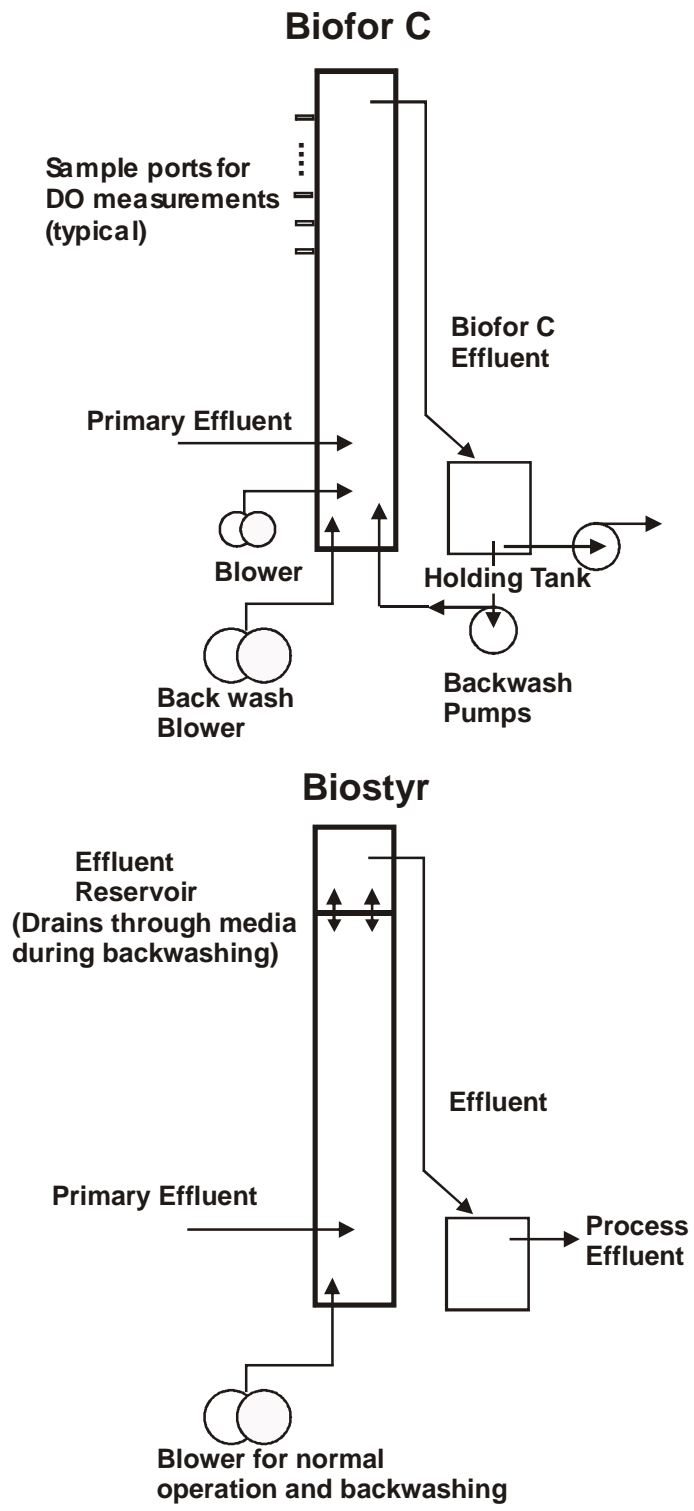

Figure 1. Column Schematics (not to scale)

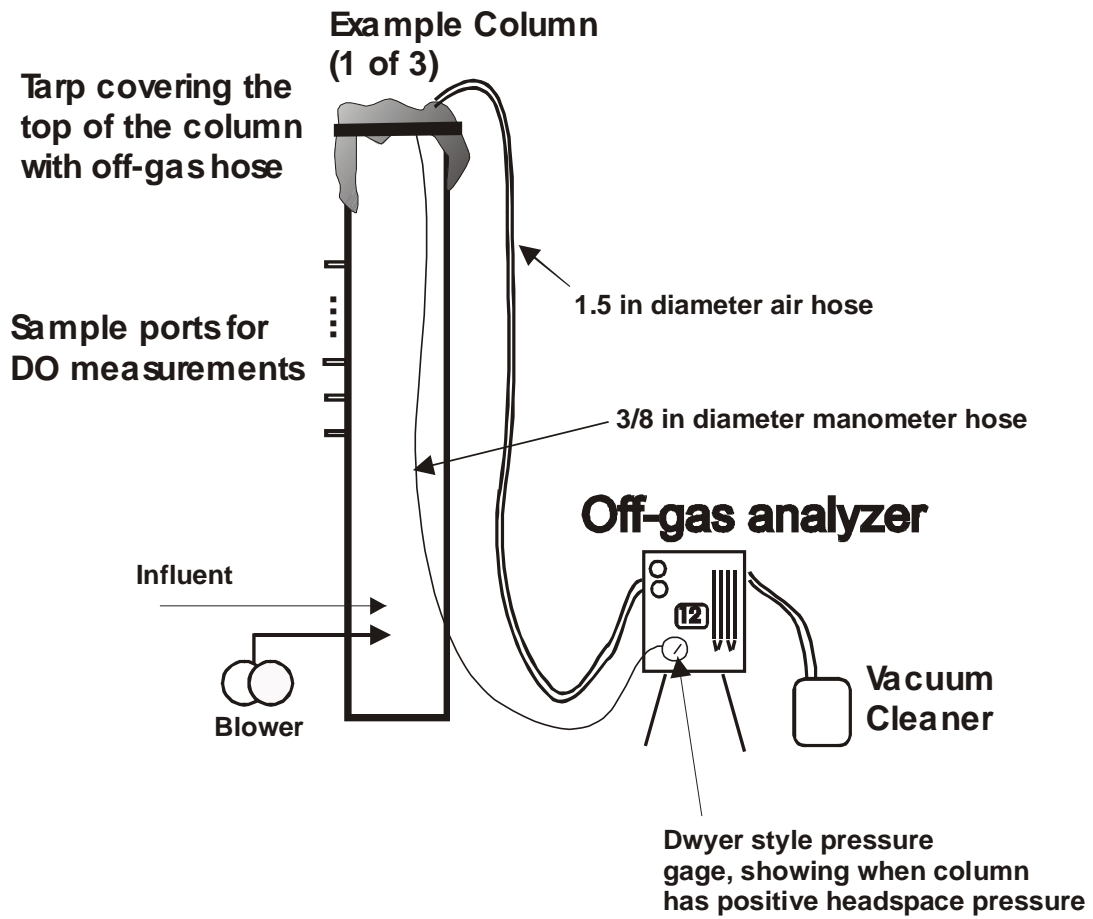

Figure 2. Schematic of Off-gas Test Setup

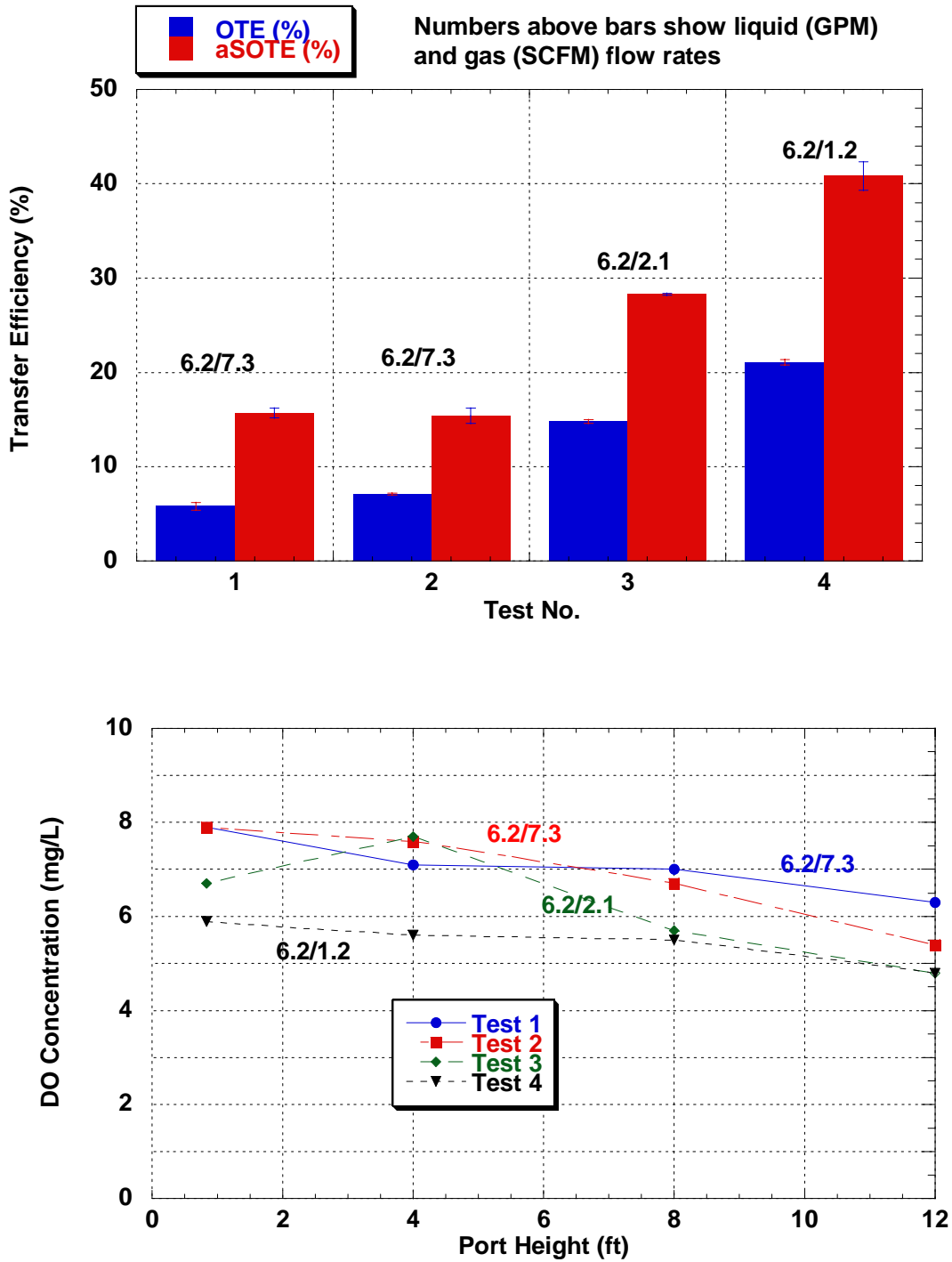

Figure 3. Biofor C results: OTE and SOTE for various tests (top) and DO concentration versus height (bottom).

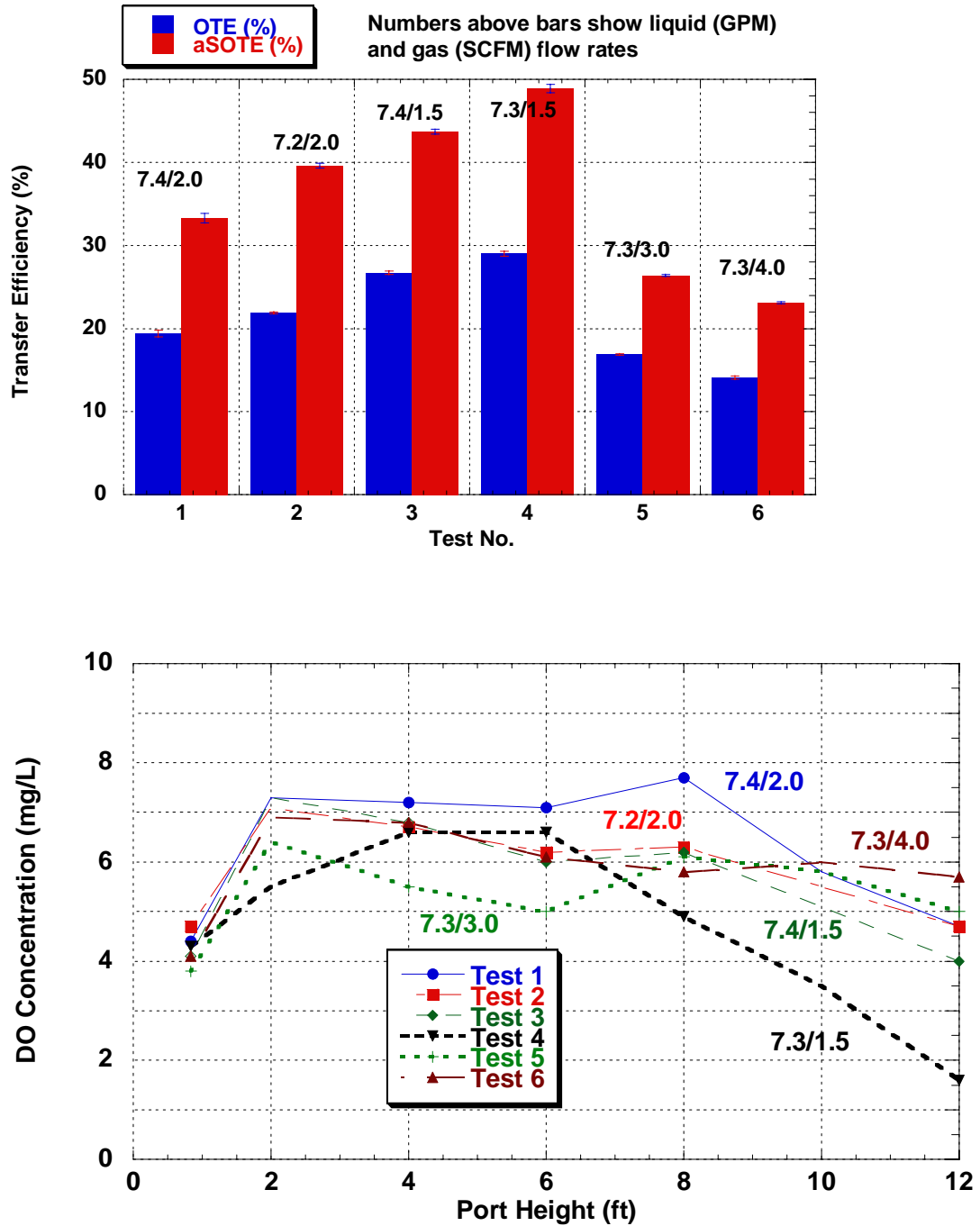

Figure 4. Biostyr results: OTE and SOTE for various tests (top) and DO concentration versus height (bottom).

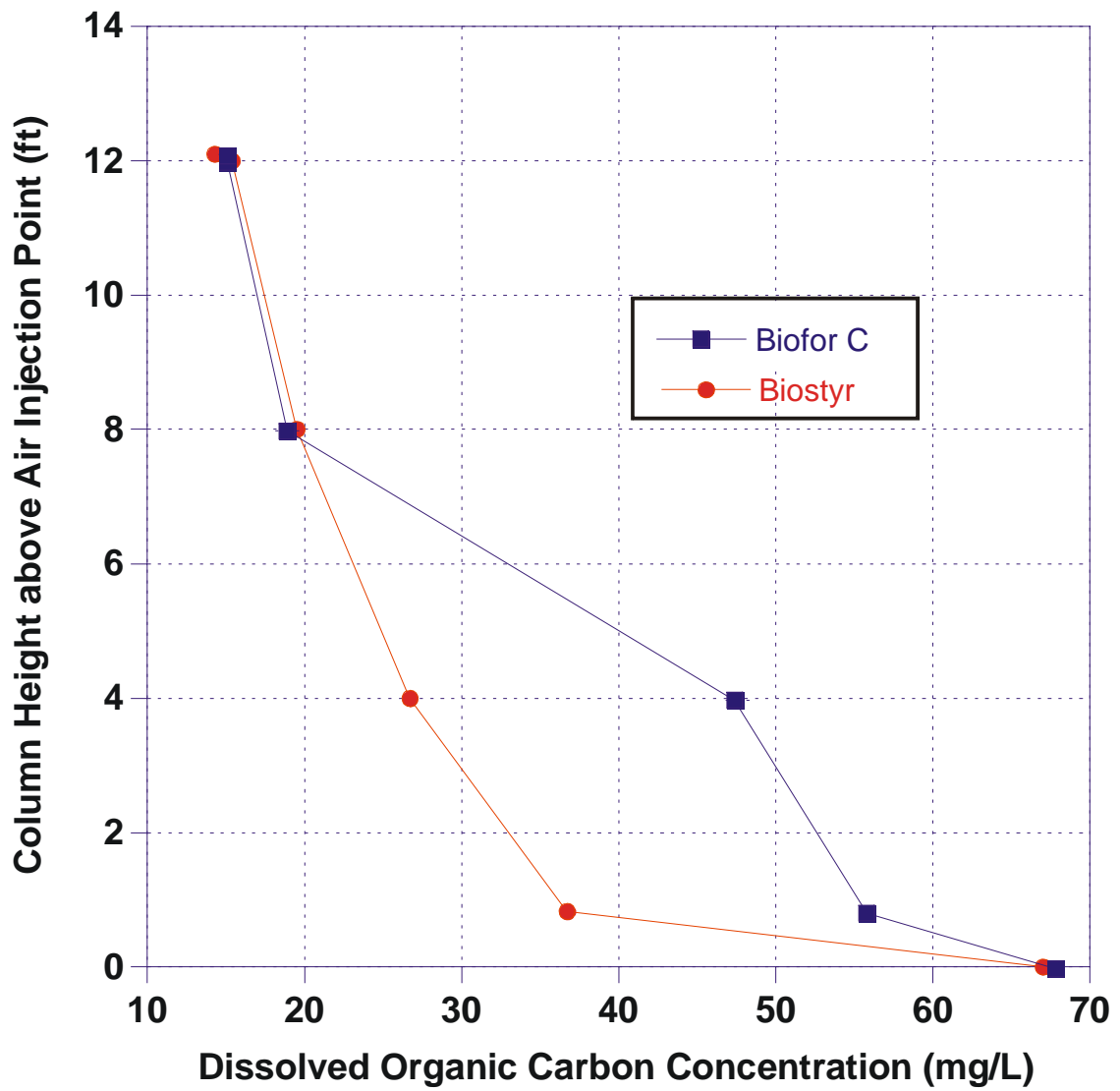

Figure 5. Dissolved organic carbon versus column height

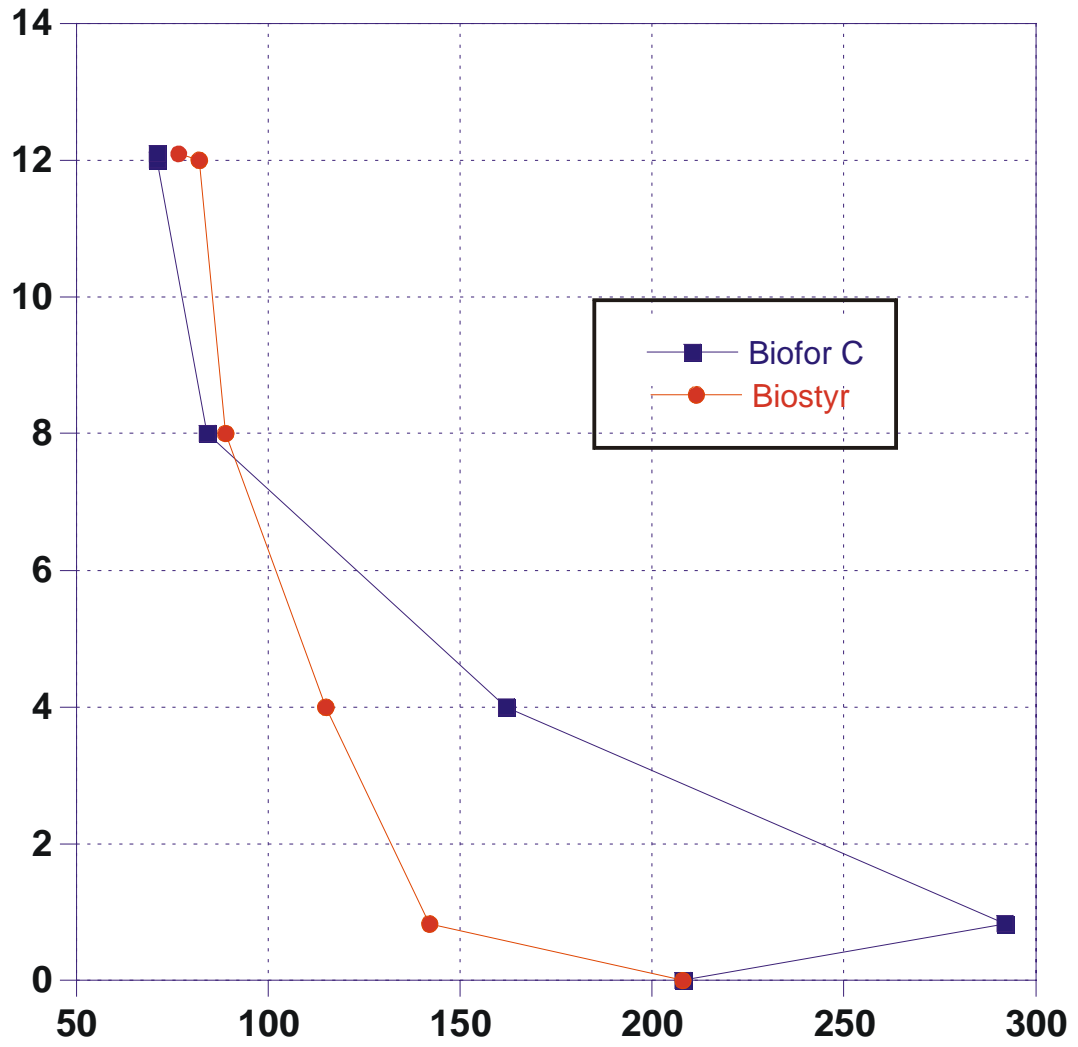

Figure 6. Chemical Oxygen Demand versus column height

APPENDIX A. OFF-GAS ANALYSIS TECHNICAL DESCRIPTION

One of the problems with aerobic wastewater treatment process design is the correct specification of aeration capacity. A variety of techniques exist for estimating the oxygen transfer capacity of an aeration system. Methods for estimating transfer can generally be divided into three categories:

Clean water testing and conversion to field rates with alpha, beta, and theta conversion factors.

Dirty water testing using methods to account for the biological consumption of oxygen during the transfer test.

Material balance methods which attempt to determine difference in input and outputs of oxygen consuming material.

All of these methods have advantages and disadvantages. When using clean water test results it is very difficult to accurately estimate the alpha factor (ratio of mass transfer coefficient in dirty water to its value in clean water). Dirty water testing requires accurate estimation of oxygen consumption rate, which is often very difficult, especially in oxygen limiting conditions, which occur in overloaded treatment plants. Material balance methods require long-term knowledge of process operating conditions such as sludge wasting rate, and are susceptible to error from sludge settling in the aeration basin or stripping of volatile oxygen consuming compounds.

A technique which has none of the above shortcomings is off-gas analysis. This method requires the capture of a representative sample of the gas, which exits the aeration basin surface, and analysis of this gas for oxygen, carbon dioxide, and water vapor content. By knowing the flow rates of gas entering and exiting the liquid, the mass transfer efficiency can be calculated. If flow rates are not known, the mass transfer efficiency can still be determined by knowing the molar percents of the reacting or changing gas constituents (oxygen, carbon dioxide, and water vapor) and assuming that the inert gas constituents (nitrogen, argon) remain constant. It must be further assumed that the transfer at the fluid surface and the atmosphere is negligible when compared to the transfer caused by the aeration system, and that steady state conditions exist during the test. Both assumptions are very good for the wastewater treatment systems.

The concept of off-gas analysis is not new and was originally described in 1939 by Sawyer and Nichols (1939). A number of later investigators continued the development of off-gas analysis, including Hover et al. (1954), Pauling et al (1968), Prit and Callow (1958) and Downing (1960). More recently Conway and Kumke (1966) and Leary et al. (1968) have used off-gas analysis. The ASCE/EPA subcommittee on oxygen transfer testing asked Ewing Engineering (Redmon et al., 1982) to further develop the technique. Their results reported at the 1982 WPCF meeting show that the off-gas technique is an accurate and precise way of estimating aeration efficiency under process conditions. New developments which make this method more precise are advances in oxygen analyzers, and the use of large off-gas collection hoods which capture more representative samples.

Off gas analysis can be used for any subsurface system regardless of the oxygen uptake rate and process conditions. Efficiencies of oxygen-limited systems can also be determined, although the transfer rate may be different than the transfer rate under normal operation. It has been documented that alpha factors vary greatly with such conditions (Stenstrom and Gilbert, 1981).

THEORY OF ANALYSIS

To determine oxygen transfer efficiency using off-gas analysis, a mass balance must be performed on the gas entering and exiting the liquid. The following description is provided, and is based largely on the analysis by Redmon et al. (1982). If the flow rates of gas entering and exiting the fluid are known, then the following mass balance can be made:

$$V_G \rho \frac{d\bar{Y}}{dt} = \rho(q_i Y_R - q_o Y_{og}) - K_L a (C_\infty^* - C)V \quad (1)$$

where:

- ρ density of oxygen at temperature and pressure of gas flow,
- q_i, q_o = total volumetric gas flow rates of inlet and outlet gasses,
- Y_R, Y_{og} = mole fractions (equivalent to volumetric fractions) of oxygen in the inlet and exit gasses,
- $K_L a$ = volumetric oxygen transfer coefficient,
- C_∞^* = equilibrium dissolved oxygen concentration in the test liquid at the given conditions,
- C = oxygen concentration,
- V = liquid volume, and
- V_G = gas hold-up volume.

At steady state the equation reduces to:

$$\rho(q_i Y_R - q_o Y_{og}) = K_L a (C_\infty^* - C)V \quad (2)$$

The left hand side of equation 2 is the amount of oxygen transferred as determined from the change in oxygen mass and flow rate of the inlet and outlet gas streams. The right hand side of equation 2 is the familiar "K rate" based upon the mass transfer coefficient and driving force.

Since it is often difficult to measure the entering gas flow rate to an aeration system, a procedure which does not rely on gas flow rates is needed. If one assumes that the inert portions of the entering gas stream do not change, a mole fraction approach can be developed which does not require gas flow rate. This assumption means that the nitrogen, argon, and inert trace gasses do not change as they pass through the aeration system. The new technique (Redmon et al., 1982) relies upon this assumption to calculate oxygen transfer efficiency (OTE).

OTE expressed as a fraction, can be derived as follows:

$$\text{OTE} = \frac{\text{mass O}_2 \text{ in} - \text{mass O}_2 \text{ out}}{\text{mass O}_2 \text{ in}} \quad (3)$$

$$= \frac{G_i (M_o / M_i) \text{MR}_{o/i} - G_i (M_o / M_i) \text{MR}_{og/i}}{G_i (M_o / M_i) \text{MR}_{o/i}} \quad (4)$$

$$= \frac{\text{MR}_{o/i} - \text{MR}_{og/i}}{\text{MR}_{o/i}} \quad (5)$$

where:

G_i = mass rate of inerts, which is constant (by assumption) in both the inlet and off-gas streams

$M_o M_i$ = molecular weights of oxygen and inerts, respectively

$\text{MR}_{o/i}, \text{MR}_{og/i}$ = mole ratio of oxygen to inerts in the inlet and off-gas streams

The mole ratio of oxygen to inerts is calculated by subtracting the mole fractions of oxygen, carbon dioxide and water vapor, as follows:

$$\text{MR}_{o/i} = \frac{Y_R}{1 - Y_R - Y_{\text{CO}_2(R)} - Y_{\text{W}(R)}} \quad (6)$$

$$\text{MR}_{og/i} = \frac{Y_{og}}{1 - Y_{og} - Y_{\text{CO}_2(og)} - Y_{\text{W}(og)}} \quad (7)$$

where:

$Y_{\text{CO}_2(R)}, Y_{\text{CO}_2(og)}$ = mole fractions of CO_2 in the reference gas(R), or off-gas (og)

$Y_{W(R)}, Y_{W(og)}$ = mole fractions of water vapor in the reference gas (R)
and off-gas (og)

The value of Y_R is the mole ratio of oxygen in air, and can be calculated by subtracting the humidity from the known (handbook) mole fraction of oxygen in dry air as follows:

$$Y_R = 0.2095(1 - Y_{W(R)}) \quad (8)$$

The mole fraction of oxygen in the off-gas must be measured experimentally, as well as the CO_2 and water vapor mole fractions. For early Ewing Mark V devices the CO_2 was measured with an Orsat, which measures the CO_2 as a volume percent. The sample off-gas is dried in the later version of the Mark V instrument, which means Y_W is zero. The oxygen mole fraction is measured with a Teledyne Model 320B analyzer, which provides a signal proportional to mole fraction, and can be calibrated directly at the pressure of the inlet air. In later instruments the CO_2 is absorbed with sodium hydroxide which removes it from the calculations. The CO_2 and water vapor are also removed from the reference gas, since it flows through the absorber column.

FLOW WEIGHTED AVERAGING

The single value of OTE obtained from a single analysis represents the transfer at a single "point" in the aeration basin. The size of the point is equivalent to the size of the collection hood. In general, larger hoods provide more representative samples of the OTE of the entire tank.

If only a few hood locations are used, erroneous results may occur. For example, if the hood is located over a break in an air pipe line, very low OTEs will be measured. To obtain a representative single average value of OTE for an aeration tank, it is necessary to sample many locations and calculate an appropriate average. In the recent EPA sponsored research project (US EPA, 1989), a protocol was developed which required sampling at least 2% of the tank surface area.

To calculate an average OTE, the individual readings must be averaged. Since aeration basins are usually tapered, each hood location generally has a different gas flow rate. If the gas flow rate at each hood location is known, a flow weighted average can be calculated. For this reason, the Ewing instruments include gas flow rate meters (rotameters) for measuring hood airflow rate, and a manometer to indicate hood pressure. When the hood pressure is stable, gas flow rate indicated by the instrument is equal to the hood collection flow rate.

In designing an off-gas experiment it is also necessary to select hood locations that are representative of specific areas of the tank. This is especially important if highly tapered aeration tanks, or tanks with irregular geometries, are being tested. To calculate a tank average, equation 9 is used:

$$\overline{\text{OTE}} = \frac{\sum_{i=1}^m A_i Q_i \text{OTE}_i}{\sum_{i=1}^m A_i Q_i} \quad (9)$$

where

i = hood location (sample number)

A_i = area associated with hood location i ,

Q_i = air flux associated with hood location i (equals the gas flow rate measured by the analyzer divided by hood area),

OTE_i = oxygen transfer efficiency measured at location i , and

$\overline{\text{OTE}}$ = overall average OTE.

This equation represents a flow-weighted, area-weighted average OTE. In cases where the tank geometry is uniform, such as a fine pore, full floor coverage aeration tank with equal sized grids, equal areas can be incorporated into the test design, and the area terms in equation 9 cancel.

If other indications of gas flow rate exist, they can be compared to the gas flow rate indicated by the instrument. The denominator of equation 9 represents the entire tank gas flow rate. If reliable plant instrumentation exists, one should expect the hood and plant flow rates to correspond very closely. The ability to accurately match the two flow rates in full-scale aeration tanks has been demonstrated (Stenstrom and Masutani, 1990). One should not expect the air flux at each hood location to match the air flux indicated by the plant instrumentation; however, if the plant instrumentation is accurate, the average airflow rate indicated by the instrument and plant instrumentation should agree.

In special cases, such as testing in pilot columns, the entire off-gas flow can be captured. In this case, no flow weight averaging is required.

CORRECTION TO STANDARD CONDITIONS

It is useful to calculate the OTE of the aeration at standard conditions, insofar as this is possible. If the mixed-liquor dissolved oxygen, temperature and TDS are measured at the same time OTE is measured, and if the equilibrium DO concentration (C_{∞}^*) is known, it is possible to calculate αSOTE . The correction is made in the same way as clean water data are corrected to standard conditions, as follows:

$$\alpha\text{SOTE} = \frac{\text{OTE } C_{\infty 20}^*}{(\Omega\beta C_{\infty T}^* - \text{DO})\Theta^{T-20}} \quad (10)$$

where:

- $C_{\infty 20}^*$ = equilibrium DO concentration at 20°C, 760 mm barometric pressure, zero salinity,
 $C_{\infty T}^*$ = equilibrium DO concentration at temperature T, 760 mm barometric pressure, zero salinity,
 Ω = barometric pressure correction factor,
 β = salinity correction factor,
 Θ = temperature correction factor (= 1.024 for the ASCE Standard, 1991),
DO = operating DO concentration, and
T = temperature, °C

The pressure correction factor Ω accounts for the effect of non-standard barometric pressures. It is calculated as follows for basins less than 6.1 m (20 ft) deep:

$$\Omega = \frac{P_b}{P_s} \quad (11)$$

where:

- P_b = barometric pressure during the test, psia
 P_s = standard atmospheric pressure 14.7 psia at 100% relative humidity

For deeper tanks a more elaborate procedure is required, as follows:

$$\Omega = \frac{P_b + 0.007\gamma_w d_e - P_{vT}}{P_s + 0.007\gamma_w d_e - P_{vT}} \quad (12)$$

where:

- γ_w = specific weight of water at temperature T, lb/ft³,
 P_{vT} = saturated vapor pressure of water at temperature T, psia, and
 d_e = effective saturation depth, at infinite time, ft

The effective depth, d_e , is defined as the depth of water under which the total pressure (hydrostatic plus atmospheric) would produce a saturation concentration equal C_{∞}^* for water in contact with air at 100% relative humidity. The value of d_e can be calculated from clean water test data, as follows:

$$d_e = \frac{\left[\frac{C_{\infty}^*}{C_s} [P_s - P_{vT}] - P_b - P_{vT} \right]}{\gamma_w 0.007} \quad (13)$$

where:

- C_s = oxygen saturation concentration at T (handbook value)

Generally for fine pore diffuser systems that are mounted no more than 10% of the overall water depth above the tank floor, the value of d_e will range between 21 and 44% of the overall water depth (US EPA, 1989).

If the standard oxygen transfer efficiency (SOTE) of the aeration systems is known from clean water tests or from manufacturer's data, the α factor can be calculated as follows:

$$\alpha = \frac{\alpha \text{SOTE}}{\text{SOTE}} \quad (14)$$

The α factor is the ratio of process water to clean water mass transfer coefficients $K_L a$. It is generally necessary to know its value when designing aeration systems. Its measurement is often the goal of process water testing. A new factor, F, was introduced in 1989 in the US EPA design manual (1989). This factor represents the state of fouling of fine pore diffusers. Generally, fine pore diffusers foul and the α factor calculated after several years of operation, especially without cleaning, can be 50% of the new α factor. (Stenstrom and Masutani, 1990). When testing aeration systems that have been in operation for any considerable period of time, the FSOTE is determined when using equation 10.

To calculate overall, average, α , F, or SOTEs, equation 9 is used by replacing OTE with the desired parameter.

REFERENCES

ASCE (1991). *ASCE Standard: Measurement of Oxygen Transfer in Clean Water*, ISBN 0-87262-430-7, New York, NY.

Conway, R.A. and Kumke, G.W. (1966). "Field Techniques for Evaluating Aerators," *Journal of the Sanitary Engineering Division*, ASCE, Vol 92, SA2, p21.

Downing, A.L. (1960). "Aeration in the Activated Sludge Process," *Institution of Public Health Engineers*, Vol 59, pp 80.

Hoover, S.R., Jasewicz, L. and Porges, N. (1954). "Measurement of Oxygen Transfer," *Inst. and Autom.*, Vol 27, p 774.

Leary, R.D., Ernest, L.A. and Katz, W.J. (1968). "Effect of Oxygen Transfer Studies of Seven Diffuser Systems," *Journal of the Water Pollution Control Federation*, Vol 40, pp 1298.

Pauling, L., Wood, R.E., Sturdivant, J.H. (1968). "An Instrument for Determining the Partial Pressure of Oxygen in a Gas," *Journal of the American Chemical Society*, Vol 68, p 795.

Prit, S.J. and Callow, D.S. (1958). "Exocellular Product Formation by Microorganisms Continuous Culture I. Production of 2:3-Butanediol by *Aerobacter Aerogenes* in a Single Stage Process," *Journal of Applied Bacteriology*, Vol 21, pp 188.

Redmon, D., Boyle, W.C. and Ewing, L. "Oxygen Transfer Efficiency Measurements in Mixed Liquor Using Off Gas Techniques," A paper presented at the 1982 WPCF Conference, St. Louis, Mo. Oct., 1982.

Sawyer, C.N., and Nichols, M.S. (1939). "Activated Sludge Oxidations -I Effect of Sludge Concentration and Temperature on Oxygen Utilization," *Sewage Works Journal*, Vol. 11, p 52.

Stenstrom, M.K., and Gilbert, R.G. (1981). "The Effect of Alpha, Beta, and Theta Factors on the Design, Specification and Operation of Aeration Systems," *Water Research*, Vol 15, pp 643-654.

Stenstrom, M.K. and Masutani, G. (1990). "Fine Pore Diffusers Fouling: The Los Angeles Studies," *UCLA Engr. 90-02*, January 1990.

U.S. EPA (1989). *Design Manual - Fine Pore Aeration Systems*, Risk Reduction Engineering Laboratory, Cincinnati, OH, EPA/625/1-89/023.

Appendix B Excel Datasheets

BIOSTYR COLUMN

Summary Section for Off-gas Analysis
Dec 9-10, 2004, San Diego BAFs

Mole Fraction (O2) 0.2095
Mole Ratio (O2/inerts) 0.2650
Ref Barometric Pres (in hg) 29.92
Theta 1.024

Hood Area (ft2) N/A
Actual Bar Pres (in hg) 29.92

Air Temp (for SCFM Calc, o C) 75
Tank SWD (ft) 20
Diffuser Sub (ft) 15
Rotocalibration (mm) 0

50 % of depth
3.25 PSI
1.221088 dE
11.07527 C* inf

Test No.	Air flow (SCFM)	H2O Flow (GPM)	Column	Ref Vol (volts)	Off-G Vol (volts)	H2O Temp (deg C)	DO (mg/L)	CO2 (%)	Beta	Off-gas Temp (deg F)	Rota 1 Reading (small)	Rota 2 Reading (big)	Roto Temp Correction	M Fraction Off-gas	M Ratio Off-gas	OTE (%)	C* inf T (mg/L)	aSOTE (%)	C* inf 20 (mg/L)	P Corr (ratio)	Abs T (deg K)	Roto Total Gas Flow (scfm)	Roto1 (scfm)	Roto2 (scfm)
1	2	7.4	Biostyr	1.002	0.841	22.5	4.40	0.00	0.99	64	5	0	1.01	0.176	0.213	19.50	10.59	33.44	11.07	1.2192	295.5	0.2	0.2	0.0
1	2	7.4	Biostyr	1.002	0.839	22.5	4.40	0.00	0.99	64	5	0	1.01	0.175	0.213	19.73	10.59	33.84	11.07	1.2192	295.5	0.2	0.2	0.0
1	2	7.4	Biostyr	1.002	0.845	22.5	4.40	0.00	0.99	64	5	0	1.01	0.177	0.215	19.03	10.59	32.64	11.07	1.2192	295.5	0.2	0.2	0.0
2	2	7.2	Biostyr	1.012	0.827	22.5	4.70	0.00	0.99	64	5	0	1.01	0.171	0.207	22.06	10.59	39.79	11.07	1.2192	295.5	0.2	0.2	0.0
2	2	7.2	Biostyr	1.015	0.832	22.5	4.70	0.00	0.99	64	5	0	1.01	0.172	0.207	21.77	10.59	39.27	11.07	1.2192	295.5	0.2	0.2	0.0
2	2	7.2	Biostyr	1.015	0.831	22.5	4.70	0.00	0.99	64	5	0	1.01	0.172	0.207	21.88	10.59	39.48	11.07	1.2192	295.5	0.2	0.2	0.0
2	2	7.2	Biostyr	1.018	0.832	22.5	4.70	0.00	0.99	64	5	0	1.01	0.171	0.207	22.05	10.59	39.77	11.07	1.2192	295.5	0.2	0.2	0.0
3	1.5	7.4	Biostyr	0.999	0.776	22.5	4.10	0.00	0.99	64	5	0	1.01	0.163	0.194	26.66	10.59	43.58	11.07	1.2192	295.5	0.2	0.2	0.0
3	1.5	7.4	Biostyr	0.999	0.774	22.5	4.10	0.00	0.99	64	5	0	1.01	0.162	0.194	26.89	10.59	43.95	11.07	1.2192	295.5	0.2	0.2	0.0
3	1.5	7.4	Biostyr	0.998	0.777	22.5	4.10	0.00	0.99	64	5	0	1.01	0.163	0.195	26.46	10.59	43.25	11.07	1.2192	295.5	0.2	0.2	0.0
3	1.5	7.4	Biostyr	0.999	0.775	22.5	4.10	0.00	0.99	64	5	0	1.01	0.163	0.194	26.77	10.59	43.76	11.07	1.2192	295.5	0.2	0.2	0.0
3	1.5	7.4	Biostyr	1.001	0.776	22.5	4.10	0.00	0.99	64	5	0	1.01	0.162	0.194	26.84	10.59	43.86	11.07	1.2192	295.5	0.2	0.2	0.0
4	1.5	7.3	Biostyr	0.942	0.714	22.5	4.30	0.00	0.99	60	5	0	1.01	0.159	0.189	28.77	10.59	48.55	11.07	1.2192	295.5	0.2	0.2	0.0
4	1.5	7.3	Biostyr	1.000	0.754	22.5	4.30	0.00	0.99	60	5	0	1.01	0.158	0.188	29.21	10.59	49.30	11.07	1.2192	295.5	0.2	0.2	0.0
5	3	7.4	Biostyr	0.999	0.860	22.5	3.80	0.00	0.99	60	5	0	1.01	0.180	0.220	16.98	10.59	26.50	11.07	1.2192	295.5	0.2	0.2	0.0
5	3	7.4	Biostyr	0.997	0.859	22.5	3.80	0.00	0.99	60	5	0	1.01	0.181	0.220	16.89	10.59	26.37	11.07	1.2192	295.5	0.2	0.2	0.0
6	4	7.4	Biostyr	1.001	0.885	22.5	4.10	0.00	0.99	60	5	0	1.01	0.185	0.227	14.22	10.59	23.25	11.07	1.2192	295.5	0.2	0.2	0.0
6	4	7.4	Biostyr	1.000	0.886	22.5	4.10	0.00	0.99	60	5	0	1.01	0.186	0.228	14.00	10.59	22.88	11.07	1.2192	295.5	0.2	0.2	0.0

Averages and ranges

	H2O Q (GPM)	Air Q (SCFM)	OTE avg (%)	OTE sd (%)	aSOTE avg (%)	aSOTE sd (%)	Air/Liquid	Liquid/Air
BioStyr 1	7.4	2.0	19.4	0.4	33.3	0.6	2.02	0.49
BioStyr 2	7.2	2.0	21.9	0.1	39.6	0.3	2.08	0.48
BioStyr 3	7.4	1.5	26.7	0.2	43.7	0.3	1.52	0.66
BioStyr 4	7.3	1.5	29.0	0.3	48.9	0.5	1.54	0.65
BioStyr 5	7.4	3.0	16.9	0.1	26.4	0.1	3.03	0.33
BioStyr 6	7.4	4	14.1	0.2	23.1	2.2	4.05	0.25

DO data

BioStyr	1	2	3	4	5	6
0.833	4.4	4.7	4.1	4.3	3.8	4.1
2	7.3	7.1	7.3	5.5	6.4	6.9
4	7.2	6.7	6.8	6.6	5.5	6.8
6	7.1	6.2	6	6.6	5	6.1
8	7.7	6.3	6.2	4.9	6.1	5.8
10	5.8	5.5	5.1	3.5	5.8	6
12	4.7	4.7	4	1.6	5	5.7

BIOFOR C COLUMN

Summary Section for Off-gas Analysis
Dec 9-10, 2004, San Diego BAFs

Mole Fraction (O2)	0.2095	Hood Area (ft2)	N/A	Air Temp (for SCFM Calc, o C)	75	50 % of depth
Mole Ratio (O2/inerts)	0.2650	Actual Bar Pres (in hg)	29.92	Tank SWD (ft)	20	3.25 PSI
Ref Barometric Theta	29.92			Diffuser Sub (ft)	15	1.221088 dE
	1.024			Rotocalibration (mm)	0	11.07527 C* inf

Test No.	Air flow (SCFM)	H2O Flow (GPM)	Column	Ref Vol (volts)	Off-G Vol (volts)	H2O Temp (deg C)	DO (mg/L)	CO2 (%)	Beta	Off-gas Temp (deg F)	Rota 1 Reading (small)	Rota 2 Reading (big)	Roto Temp Correction	M Fraction Off-gas	M Ratio Off-gas	OTE (%)	C* inf T (mg/L)	aSOTE (%)	C* inf 20 (mg/L)	P Corr (ratio)	Abs T (deg K)	Roto Total Gas Flow (scfm)	Roto1 (scfm)	Roto2 (scfm)
1	7.3	6.2	Biofor C	1.001	0.956	25.9	6.30	0.00	0.99	80	5	0	0.99	0.200	0.250	5.62	9.94	15.29	11.07	1.2192	298.9	0.2	0.2	0.0
1	7.3	6.2	Biofor C	0.997	0.950	25.9	6.30	0.00	0.99	80	5	0	0.99	0.200	0.249	5.89	9.94	16.02	11.07	1.2192	298.9	0.2	0.2	0.0
2	7.3	6.2	Biofor C	1.009	0.955	25.9	5.40	0.00	0.99	80	5	0	0.99	0.198	0.247	6.68	9.94	14.48	11.07	1.2192	298.9	0.2	0.2	0.0
2	7.3	6.2	Biofor C	1.080	1.017	25.9	5.40	0.00	0.99	80	5	0	0.99	0.197	0.246	7.27	9.94	15.76	11.07	1.2192	298.9	0.2	0.2	0.0
2	7.3	6.2	Biofor C	1.001	0.942	25.9	5.40	0.00	0.99	80	5	0	0.99	0.197	0.246	7.34	9.94	15.92	11.07	1.2192	298.9	0.2	0.2	0.0
3	2.1	6.2	Biofor C	0.996	0.876	25.9	4.80	0.00	0.99	80	5	0	0.99	0.184	0.226	14.77	9.94	28.22	11.07	1.2192	298.9	0.2	0.2	0.0
3	2.1	6.2	Biofor C	0.998	0.877	25.9	4.80	0.00	0.99	80	5	0	0.99	0.184	0.226	14.86	9.94	28.39	11.07	1.2192	298.9	0.2	0.2	0.0
4	1.2	6.2	Biofor C	1.004	0.833	26.8	4.80	0.00	0.99	80	5	0	0.99	0.174	0.210	20.62	9.78	39.81	11.07	1.2192	299.8	0.2	0.2	0.0
4	1.2	6.2	Biofor C	1.008	0.827	26.8	4.80	0.00	0.99	78	5	0	0.99	0.172	0.208	21.68	9.78	41.87	11.07	1.2192	299.8	0.2	0.2	0.0

Averages and ranges

	H2O Q (GPM)	Air Q (SCFM)	OTE avg (%)	OTE sd (%)	aSOTE avg (%)	aSOTE sd (%)	Air/Liquid	Liquid/Air
Biofor C 1	5.4	7.3	5.8	0.2	15.7	0.5	10.10	0.10
Biofor C 2	5.4	7.3	7.1	0.4	15.4	0.8	11.26	0.09
Biofor C 3	5.4	2.1	14.8	0.1	28.3	0.1	3.19	0.31
Biofor C 4	5.4	1.2	21.1	0.8	40.8	1.5	1.88	0.53

DO data

Ports	Biofor C			
	1	2	3	4.0
0.833333	7.9	7.1	7	6.3
4	7.9	7.6	6.7	5.4
8	6.7	7.7	5.7	4.8
12	5.9	5.6	5.5	4.8

Appendix C- Photographs

(pictures 1 through the top of 4 provided by H. Melcer, Brown and Caldwell)

(Refer to Appendix C of Off-Gas Testing Report, June 26 2004)