

# 2013 Annual Report and Summary for the South Bay Wastewater Reclamation Plant & Ocean Outfall



NPDES No. CA 0109045

Order No. R9-2013-0006

&

Order No. 2000-203



This page left blank intentionally.



THE CITY OF SAN DIEGO

June 30, 2014

Mr. David W. Gibson, Executive Officer  
California Regional Water Quality Control Board  
2375 Northside Drive, Suite 100  
San Diego, CA 92108

Attn: POTW Compliance Unit

Dear Mr. Gibson:

Enclosed is the 2013 South Bay Water Reclamation Plant and Ocean Outfall Annual Reports and Summary, as specified in discharge Order No. R9-2013-0006 and the superseded Order No. R9-2013-0006, NPDES Permit No. CA0109045.

I certify under penalty of law that this document and all attachments were prepared under my direction or supervision in accordance with a system designed to assure that qualified personnel properly gather and evaluate the information submitted. Based on my inquiry of the person or persons who manage the system, or those persons directly responsible for gathering the information, I certify that the information submitted is, to the best of my knowledge and belief, true, accurate, and complete. I am aware that there are significant penalties for submitting false information, including the possibility of fine and imprisonment for knowing violations.

Sincerely,

Peter Vroom, Ph.D.  
Deputy Director  
Environmental Monitoring & Technical Services Division

BGB/caq

cc: EPA Region 9  
San Diego County Department of Environmental Health  
Distribution  
File



This page left blank intentionally.

City of San Diego  
Public Utilities Department  
Environmental Monitoring & Technical Services Division

**Table of Contents**

I.	Introduction	11
	A. Executive Summary:.....	11
	B. Explanatory Notes:.....	12
	C. Reporting Definitions.....	13
	D. Overview of the Metropolitan Wastewater (Metro) System.....	14
	E. Overview of SBWRP\.....	17
	F. Discussion of Compliance Record.....	19
	G. Plant Facility Operation Report .....	22
	H. Correlation of Results to Plant Conditions .....	28
II.	Influent and Effluent Data Summary	29
	A. Mass Emissions.....	31
	B. Discharge Limits.....	34
	C. Influent and Effluent Data Summaries .....	37
	D. Influent and Effluent Graphs .....	62
	E. Daily Values of Selected Parameters. ....	89
	F. Toxicity Testing: South Bay Water Reclamation Plant 2013.....	98
III.	Plant Operations Summary	109
	A. Flows.....	114
	B. Rain Days.....	122
	C. Chemical Report .....	124
	D. Facilities Out of Service Report.....	127
IV.	Combined Ocean Outfall Data	133
V.	Ocean Monitoring Data Summary	147
	A. Ocean Sediment Chemistries.....	150
	B. Fish Tissue Data.....	172
	C. Seawater Data .....	183
VI.	Annual Pretreatment Program Data	203
VII.	Reclaimed Water Data Summary.	243
	A. Reclaimed Water Data Summaries .....	245
	B. Reclaimed Water Graphs .....	259
	C. Daily Values of Selected Parameters.....	266
	D. Total Coliform Data Summaries.....	277
	E. UV Performance 2013 .....	279
VIII.	Other Required Information.	281
	A. Notes on Specific Analyses: .....	283
	B. Report of Operator Certification.....	284
IX.	Appendices	285
	A. Terms and Abbreviations used in this Report.....	287
	B. Methods of Analysis .....	289
	C. Frequency of Analysis and Type of Sample - 2013.....	298
	D. Laboratories Contributing Results used in this report. ....	300
	E. Staff Contributing to this Report.....	311

This page left blank intentionally.

Credits and Acknowledgements

**South Bay Wastewater Reclamation Plant and Ocean Outfall Annual  
Monitoring Report  
2013**

---

City of San Diego  
Public Utilities Department  
Metropolitan Wastewater Branch

---

Environmental Monitoring & Technical Services Division  
Wastewater Chemistry Laboratory  
5530 Kiowa Drive  
La Mesa, CA 91942  
Phone: (619) 668-3215 FAX: (619) 668-3284

**Supervising Editors & Science Staff:**

Brent Bowman  
Lee King

**Editorial Production & Support**

Corinna Quinata

**Data Management, Report Generation, Data Tables & Graphics**

Fernando Martinez

---

Treatment & Disposal Division

2411 Dairy Mart Road  
San Diego, CA  
Phone: (619) 428-7306 FAX: (619) 428-6915

**South Bay Wastewater Reclamation Plant Superintendent**

Ernesto Molas

**Senior WW Operations Supervisor**

Kip Cooper

**Senior Plant Technician Supervisor**

Robert Rodriguez

**WW Operations Supervisor- Process Control**

Linda Ruiz Lopez

This page left blank intentionally.



## Introduction

- A. Executive Summary
- B. Explanatory Notes
- C. Reporting Definitions
- D. Overview of the Metropolitan Wastewater (Metro) System
- E. Overview of SBWRP
- F. Discussion of Compliance Record
- G. Plant Facility Operations Report
- H. Correlation of Results to Plant Conditions

This page left blank intentionally.

---

## I. Introduction

### A. Executive Summary:

#### Purpose:

This report meets the annual reporting requirements of Monitoring and Reporting Program (MRP) in Order No. R9-2013-0006 (NPDES Permit No. CA0109045), Order No. R9-2013-0006 superseded R9-2006-0067 on April 3, 2013. This report contains summaries for Order No. 2000-203 relating to the production and purveyance of recycled water at the South Bay Water Reclamation Plant (SBWRP). It also serves as an historical record and reference of operational and compliance metrics.

#### Background:

The South Bay Water Reclamation Plant (SBWRP) is located at the intersection of Dairy Mart and Monument Roads in the Tijuana River Valley. The plant relieves the South Metro Sewer Interceptor System and provides local wastewater treatment services and reclaimed water to the South Bay. The plant opened in May 2002 and has a wastewater treatment capacity of 15 million gallons a day. The plant shares the South Bay Ocean Outfall (SBOO) with the International Wastewater Treatment Plant operated by the U.S. Section of the International Boundary and Water Commission (IBWC). While the plant has been operating since May 2002, distribution of reclaimed water started 4-years later in July 2006. The volume reclaimed and distributed varies depending on demand for recycled water.

During 2013, the plant received and treated 2.9 billion gallons of wastewater, reclaiming 74% or 2.1 billion gallons. Fifty four percent of the reclaimed water was beneficially reused by the Otay Water District, the International Treatment Plant, or used for in-plant processes. Between the months of May thru October more than seventy percent of the reclaimed water was reused.

<b>Key metrics for 2013</b>	<b>Daily Average Flow (mgd)</b>	<b>Total Annual Flow (million gallons)</b>
Influent to plant (Raw Wastewater Treated)	8.08	2,948
Effluent to Ocean Outfall	3.22	1,171
Reclaimed Water Produced	5.96	2,176
Beneficial Reuse (recycled water distributed)	3.20	1,172
Sludge and returns to South Metro Interceptor (SMI)	1.62	590
Plant Use of Reclaimed Water	0.77	282

For a detailed discussion of the plant and treatment process see sections I. F., Plant Facility Operation Report, and Chapter III. Plant Operations Summary.

## B. Explanatory Notes:

The past year's data are presented in tabular and graphical form. We include annual monitoring results, special items and discussions itemized in the permits. This document is comprehensive, including supporting information on monitoring methods, frequency and changes in analyses, long-term tables of selected analytes, operational data, background analyses and treatment plant process control. Where the permit sets limits or requests the analysis of various groups of compounds (such as chlorinated and non-chlorinated phenols, PCBs, hexachlorocyclohexanes, etc.) we have provided summaries and averages of these groups and also of the individual compounds.

The Recycled Water Users Summary Report as described in Permit No. 2000-203 is submitted separately from this report. However, we do include summary information and an evaluation of the Water Reclamation and beneficial reuse integral to the operations of the plant. Section 7 contains a thorough presentation and evaluation of the Reclaimed Water process information and monitoring data.

For averaging purposes, "less than" and "not detected" (nd) values were treated as zero. In many parts of the report, zero values are found. Our computer system reads "less than" values as zero for summaries, and in computing averages. In those areas where zeros are found the reader can find appropriate method detection limits (MDL) in the table of data. Because "less than" values are averaged as zero, values in summary tables may be less than detection limits; these are simple numeric means (or minimums). The data tables may also contain values expressed as a <X (less than), where X represents the MDL.

A further limitation is that statistical confidence in the results of an analysis is heavily dependent upon the concentration relative to the Method Detection Limit (MDL). Essentially all of our detection limits have been established using the procedure in 40 CFR, part 136. This statistical basis for the MDL results in a defined statistical confidence (at the 99% Confidence Interval) of essentially  $\pm 100\%$  when the result is near the MDL. Only at concentrations approximately 5 times the MDL is the confidence interval at  $\pm 20\%$ . While the precision of our methods generally ranges from 2–3 significant figures, the above limitations of confidence should always be considered.

Where possible, the influent and effluent values of a given parameter have been included on the same graph to make the removals and other relationships readily apparent. Please note that many of the graphs are on expanded scales where the y-axes (concentration) do not start at zero, but instead are scaled to highlight the range of concentrations where variation takes place. These expanded scales make differences and some trends obvious that might normally not be noticed; however, they also may inadvertently place more weight on relatively minor changes or trends than deserved. Please reference the chart axis scales.

## C. Reporting Definitions

### a. Estimated Concentrations (“E” Qualifier)

The “E” qualifier stands for “estimated value,” and is used in data reduction to flag data that have a lower concentration than normally acceptable for monitoring programs, or the method under federal regulations or ELAP requirements, but the qualitative identification has high certainty. Using normal detection limit criteria, useful information would be lost. In making determinations and reporting data there are circumstances where, due to the nature of the analysis and the needs of the customer, the certainty in quantification can be less than the requirements necessary for general environmental monitoring and reporting for regulatory compliance.

Data annotated with an “E” followed by a value (always less than the reported MDL) are estimated values. Data annotated in this manner have an uncertainty in concentrations unacceptable for compliance determinations or other concentration dependent conclusions.

### b. Detected, but not qualified (“DNQ” Qualifier)

The “DNQ” qualifier is used for NPDES effluent reporting. DNQ is for analytical results that are less than the minimum level (ML), but greater than or equal to the MDL. Data annotated with DNQ will include a value, and the method’s MDL.

#### Summary of E and DNQ qualifiers

- E qualifier data in LIMS will have an “E” in the qualifier column, a value in the result value column, and the MDL deleted.
- DNQ qualifier data in LIMS will have a “DNQ” in the qualifier column, a value in the result value column, and the MDL.

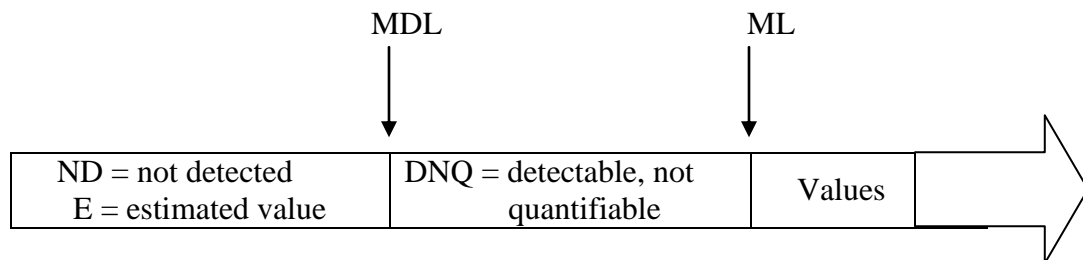

## D. Overview of the Metropolitan Wastewater (Metro) System

The City operates wastewater facilities to transport, treat, reclaim, reuse, and discharge wastewater and its by-products collected from the Metropolitan Wastewater System (the System). The System serves a population of approximately 3.2 million people providing for conveyance, treatment, reuse, and disposal of wastewater within a 450 square mile service area. The Metro System currently consists of several service areas including the City of San Diego (serviced by the Municipal Sub-System) and the 15-regional Participating Agencies. Wastewater treatment for the System is provided at the North City Water Reclamation Plant (NCWRP), the South Bay Water Reclamation Plant (SBWRP), and the Point Loma Wastewater Treatment Plant (PLWTP). Solids treatment and handling provided at the PLWTP and the Metro Biosolids Center (MBC). The City of San Diego contributes approximately 65% of the flow in the Metro System with the remainder coming from the Participating Agencies.

Each Participating Agency is responsible for the wastewater collection system within its boundaries to the point of discharge to the System. Wastewater flows from the Municipal Sub-System compose approximately 65% of the Metro Sub-System flows. All System facilities are owned by the City of San Diego and are managed by PUD.

A map detailing major facilities in the System and the participating agencies is included.

The System is a complex system of pipelines and pump stations that collect wastewater and convey it for treatment and disposal or reuse. The PLWTP serves as the terminus for the System and is capable of treating all flows generated within the System. Within the System are two water reclamation plants, the NCWRP and the SBWRP, that pull flow from the sewers for treatment and reuse. The System also includes the Metro Biosolids Center (MBC) that treats and disposes of all treatment process solids material removed by the treatment plants.

The PLWTP is the largest of the wastewater treatment plants in the System. The PLWTP is an advanced primary treatment WWTP that uses chemical addition to increase performance of the primary clarifiers and is the terminus for the System. The PLWTP discharges effluent through the Point Loma Ocean Outfall (PLOO). As an advanced primary treatment WWTP, performance is not measured entirely by effluent quality, but also against the California Ocean Plan and the Basin Plan that address the water quality and beneficial uses of the Pacific Ocean.

The plant has a rated capacity of 240 million gallons per day (mgd) and currently operates at 144 mgd. The NCWRP has a rated capacity of 30 mgd and currently operates at a nominal flow-rate of 15.4 mgd. The SBWRP has a rated capacity of 15 mgd and is currently treating a nominal 8.0 mgd. The PLWTP is a modern primary treatment facility and the NCWRP and SBWRP are both modern tertiary treatment facilities.

The other two facilities, the NCWRP and the SBWRP are scalping plants that divert water from the System and treat it for reclamation purposes. Both plants currently operate as secondary treatment plants and reclaim water to tertiary standards to meet demand. Demand will fluctuate depending on the time of year and the type and number of customers. The NCWRP returns all secondary effluent that is not reclaimed back to the System for treatment at the PLWTP. However, the solids that are removed, either by sedimentation or biological oxidation, are pumped to the MBC for further treatment. The

SBWRP discharges excess secondary effluent to the SBOO and returns all solids removed from the sewage to the System for transport to the PLWTP. Performance of both water reclamation plants is measured by each facility's ability to treat reclaimed water to the required standards when discharging to the reclaimed system. Performance of the SBWRP is also measured via secondary treatment standards, as defined in the facility's NPDES permit, when discharging to the South Bay Ocean Outfall (SBOO).

The MBC processes primary and secondary solids from the NCWRP through anaerobic digestion and dewatering, and processes the digested biosolids from the PLWTP through dewatering. The dewatered biosolids are beneficially used as cover at a local landfill or used as a soil amendment for agricultural purposes. The centrate from the centrifuges is returned to the sewer and treated at the PLWTP. Performance of this facility is measured by the quality of the solids product generated for use or disposal.

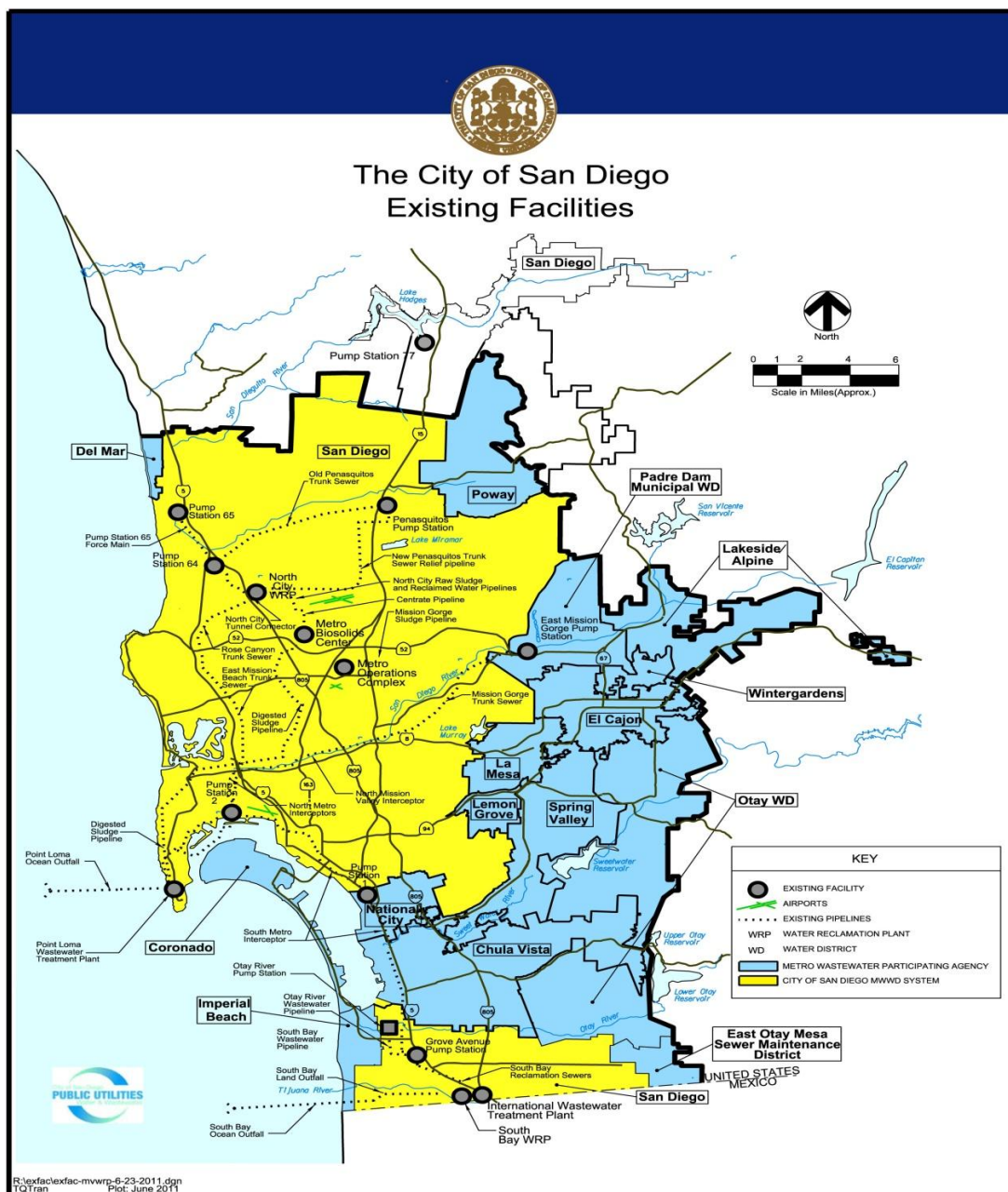

## ISO 14001 Certification

Wastewater Treatment and Disposal Division (formerly called Operations and Maintenance Division) and the Monitoring and Reporting Programs operated by the Environmental Monitoring and Technical Services Division are certified in ISO<sup>1</sup> 14001, Environmental Management Systems.

---



---

<sup>1</sup> International Standards Organization



## E. Overview of SBWRP\

The **South Bay Water Reclamation Plant (SBWRP)** relieves the South Metro Sewer Interceptor System and provides local wastewater treatment services and reclaimed or recycled water to the South Bay. The plant opened in May 2002 and has a wastewater treatment capacity of 15 million gallons a day. The plant design incorporates the newest technologies and provides advanced treatment for up to 15 million gallons of wastewater per day.



The advanced treatment meets tertiary or reclaimed water standards including disinfection. The SBWRP treatment process is a state-of-the-art implementation of traditional secondary treatment using activated-sludge. Much of the secondary effluent is reclaimed and beneficially reused after tertiary filtration through anthracite coal beds and disinfection with high-intensity ultraviolet (UV) light. The plant shares the South Bay Ocean Outfall (SBOO) with the International Wastewater Treatment Plant (IWTP) operated by the U.S. Section of the International Boundary and Water Commission (IBWC).

Treatment processes consist of mechanical bulky debris and grit removal at the headworks using standard traveling bar screens and aerated grit chambers. The removed debris is then dewatered and taken to landfills. Suspended solids of wastewater are removed by primary sedimentation. Scum removal is concurrent with primary sedimentation. Primary effluent is followed by industry standard aerated activated sludge secondary treatment. Secondary clarifiers allow settling and removal of the remainder of the solids (also called sludge) that is returned to the Metro System via the South Metro Interceptor and is pumped to the Point Loma WWTP. The resultant secondary effluent is either discharged to the South Bay Ocean Outfall or directed to tertiary treatment in the plant.



In 2013, approximately three quarters of the influent treated was directed to tertiary treatment. Tertiary treatment consists of running the secondary effluent through anthracite coal beds where it is filtered of remaining solids as it passes through the layered medium. The filtered water then passes through chambers where it is disinfected through exposure to high-energy ultraviolet light (UV). At this stage the "reclaimed" water meets California Title 22 full body contact requirements. Recycled or reclaimed water is beneficially reused for in-plant processes at SBWRP, at the nearby International Wastewater Treatment Plant and an increasing percentage of the recycled water is distributed to the Otay Water District for non-potable beneficial reuse off-setting demands for traditional potable water sources.

## South Bay Ocean Outfall (SBOO)

The South Bay Water Reclamation Plant (SBWRP) is located at 2411 Dairy Mart Road, San Diego, CA 92154. It sits at the intersection of Dairy Mart and Monument Roads in the Tijuana River Valley just meters north of the U.S.-Mexico International border. The plant provides additional treatment capacity and reclaimed water for the southern service area of the Metro System (South Metro Sewer Interceptor System).

The South Bay Ocean Outfall extends approximately 3.5 miles offshore and discharges effluent in approximately 100 feet of water. The outfall tunnel has an 11 foot diameter and is 19,000 feet long.

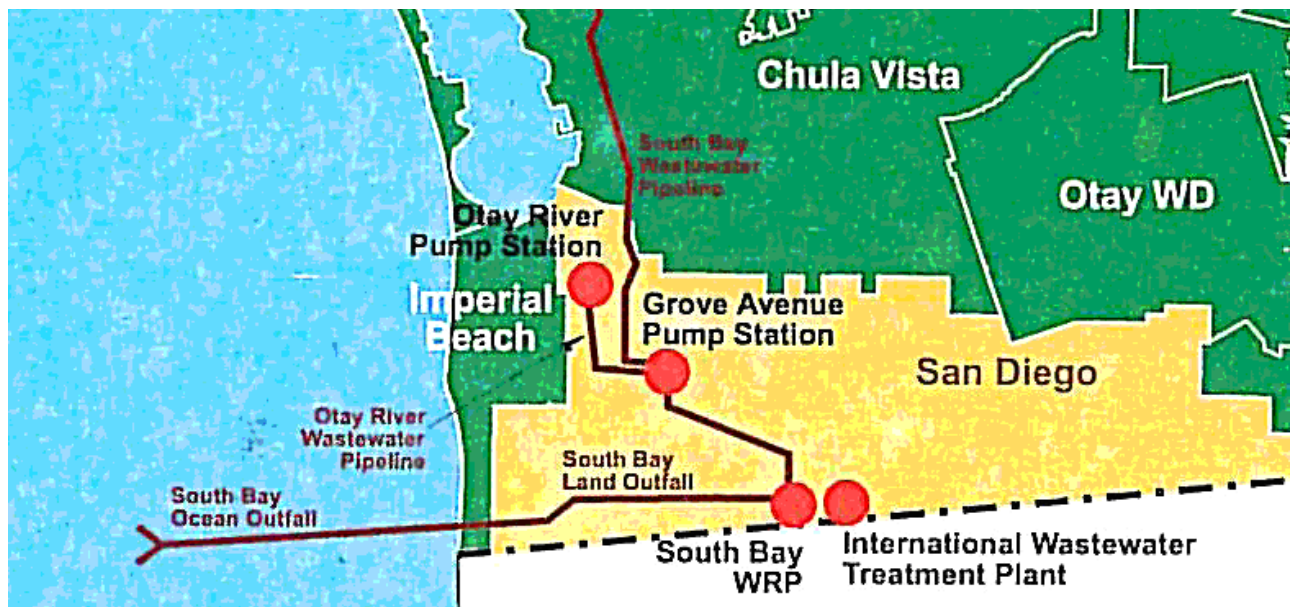

F. Discussion of Compliance Record

The South Bay Water Reclamation Plant operates with two separate permits. NPDES Permit No. CA0109045/ Order No. 2013-0006 (with addenda) provides for the treatment and disposition of wastewater via the shared South Bay Ocean Outfall and Reclaimed Water Permit No. 2000-203 (with addenda) provides for water reclamation.

**South Bay Ocean Outfall:**

There were no discharge limitations exceeded for the South Bay Ocean outfall in 2013.

**Recycled (Reclaimed) Water:** This is the eighth year of operating where reclaimed water was produced and distributed.

Chloride

The monthly average chloride limit was exceeded in 6 months in 2013. In 2013, the monitoring of chloride continued at an accelerated schedule of weekly sampling and analysis. The monthly average was calculated as a running 30 day average and the calculated values above the 260 mg/L limit are shown in table below. The increase in the concentration of chloride in the reclaimed water to levels just above the monthly average limit is attributable to a similar increase in the chloride concentration of the influent to the plant from the wastewater collections system. The chloride limit is based on a Secondary MCL for aesthetics, i.e. taste, not a health concern. Reclaimed water from the SBWRP is not used for human consumption.

30 day running average chloride above 260 mg/L in 2013			
Date	30-Day Avg.	Date	30-Day Avg.
2-Jan-13	272	3-Apr-13	283
8-Jan-13	273	9-Apr-13	282
15-Jan-13	276	16-Apr-13	280
22-Jan-13	278	23-Apr-13	279
29-Jan-13	280	30-Apr-13	276
5-Feb-13	280	7-May-13	275
12-Feb-13	278	14-May-13	276
19-Feb-13	276	21-May-13	274
26-Feb-13	277	28-May-13	272
6-Mar-13	277	5-Jun-13	268
12-Mar-13	278	11-Jun-13	262
19-Mar-13	279		
26-Mar-13	283		

### Coliform

On July 28 and 31, 2013 the 7-day median coliform value exceeded the limit of 2.2 MPN with values of 4.5 MPN on each day. On August 1 through 7, 2013 the 7-day median coliform values exceeded the limit of 2.2 MPN with values of 7.8, 13.0, 4.5, 6.8, 6.8, 7.8 and 6.8 MPN, respectively. Also on August 2, 2013 the total coliform value of 33 MPN exceeded the limit of not more than one sample above 23 MPN in a 30-day period.

<b>Reclaimed Water Permit No. 2000-203</b>		
<b>Month</b>	<b>Number of measures exceeding limits.</b>	<b>Comments: (see monthly report for further details.)</b>
January 2013	5	The 30-day average value for Chloride exceeded the limit of 260 mg/L on 5 days.
February 2013	4	The 30-day average value for Chloride exceeded the limit of 260 mg/L on 4 days.
March 2013	4	The 30-day average value for Chloride exceeded the limit of 260 mg/L on 4 days.
April 2013	5	The 30-day average value for Chloride exceeded the limit of 260 mg/L on 5 days.
May 2013	4	The 30-day average value for Chloride exceeded the limit of 260 mg/L on 4 days.
June 2013	2	The 30-day average value for Chloride exceeded the limit of 260 mg/L on 2 days.
July 2013	2	The 7-day median for Total Coliform exceeded the limit of 2.2 MPN on 2 days.
August 2013	7	The 7-day median for Total Coliform exceeded the limit of 2.2 MPN on 7 days.
September 2013	none	
October 2013	none	
November 2013	none	
December 2013	none	
Total:	33	

Ranges of Major Constituents in Reclaimed Water, 2013.

<b>Waste Discharge and Water Recycling Requirements for the South Bay Water Reclamation Plant (Order No. 2000-203)</b>			
<b>Parameter</b>	<b>Permit Limits</b>		<b>Measured Values CY 2013</b>
BOD <sub>5</sub>	Monthly Average	30 mg/L	<2 - 8
	Daily Maximum	45 mg/L	ND – 20
Total Dissolved Solids (TDS)	Monthly Average	1,200 mg/L	925 - 1090
	Daily Maximum	1,300 mg/L	788 - 1270
Sulfate	Monthly Average	250 mg/L	142 - 183
	Daily Maximum	300 mg/L	140 - 192
MBAS	Monthly Average	0.5 mg/L	0.05 – 0.14
	Daily Maximum	0.7 mg/L	0.05 – 0.15
Iron	Monthly Average	0.3 mg/L	ND – 0.087
	Daily Maximum	0.4 mg/L	ND – 0.087
Fluoride	Monthly Average	1.0 mg/L	0.52 – 0.57
	Daily Maximum	1.2 mg/L	0.48 – 0.78
Total Coliform	Daily Maximum	MPN 240/100-mLs	<1.8 – 130

## G. Plant Facility Operation Report

### SOUTH BAY WATER RECLAMATION PLANT 2013 ANNUAL FACILITY REPORT Prepared by Plant Superintendent Ernesto Molas

This facility report summarizes some of the key operational considerations involved in the facility operation of the South Bay Water Reclamation Plant (SBWRP) during calendar year 2013. Numerical data and analyses presented in this section are based on plant staff work. Refer to the laboratory data in this document for validated results for official reporting purposes.

#### **Influent Sampling:**

Plant staff members continue to implement a preventive maintenance program of switching and cleaning of the sample delivery pumps on a regular basis to ensure consistency in samples.

#### **Basin Utilization:**

The number of basins online for each unit meets the plant's overflow rates and detention time design criteria ranges which are as follows:

- 3 Primary Tanks on line with 2 offline as backups
- 5 Aeration Basin on line with 3 offline as backups
- 5 Secondary Basin on line with 3 as offline as backups

#### **Influent Flows:**

The design capacity of the plant is 15 million gallons per day (MGD), with a peak capacity of 18 MGD. The average daily influent flow treated during 2013 was 8.08 MGD. Effluent flow discharged to the ocean outfall was 3.21 MGD. Total reclaimed water usage was 3.99 MGD with 3.21 MGD of this total being sold to customers, and the remaining 0.78 MGD used internally for filter backwashing and as utility water for plant equipments and processes.

#### **Solids Handling:**

The influent screening and washer/compaction units operated well, with adequate on-site hopper capacity. Approximately 24.57 tons of screenings were disposed of through the end of December 2013. Grit storage capacity was also adequate with 26.68 tons of grit hauled off site. All primary scum was returned to the PUD collection system (for treatment at the Point Loma WWTP facility) by routing the scum collection discharge to the blended sludge pump wet well. Primary and secondary sludge was also routed to the collection system via the blended sludge pumps. The activated sludge process was maintained through the use of high capacity wasting directly from the aeration basins to the blended sludge pumps during the full period of 2013 operation. Average daily totals for blended sludge volumes returned to the Point Loma facility via the South Metro Interceptor were 1.61 MGD.

#### **Secondary Performance:**

Secondary treatment performance for total suspended solids (TSS) and biochemical oxygen demand (BOD) averages 8.4 mg/L for TSS and 13.3 mg/L for BOD in 2013. Average secondary effluent turbidity was 3.9 NTU. MCRT has typically been maintained between 5 to 7 days.

### **Tertiary Processes:**

The average filter effluent turbidity for 2013 was 0.66 NTU. All seven filters were available for operation, and 4 to 5 filters were on line to meet the RW demand.

Chlorine is added at the UV influent to control algal growth. The total chlorine residual is maintained at or below 0.5 mg/l. The frequency of chlorine addition is 12 hrs/day.

### **Water Reclamation & Distribution:**

RW water was delivered to IBWC (International Boundary Water Commission) at an average daily rate of less than 0.5 MGD throughout the year, and the average delivery rate to Otay Storage tank during summer months was 5 to 7 mgd and only less than 1 mgd during the winter months.

### **Discussion of compliance record:**

#### **Coliform**

On July 28 and 31, 2013 the 7-day median coliform value exceeded the limit of 2.2 MPN with values of 4.5 MPN on both days.

On August 1 through 7, 2013 the 7-day median coliform value exceeded the limit of 2.2 MPN with values of 7.8, 13.0, 4.5, 6.8, 6.8, 7.8 and 6.8 MPN, respectively. Also on August 2, 2013 the total coliform value of 33 MPN exceeded the limit of not more than one sample above 23 MPN in a 30-day period.

Coliform analysis was initiated on the October 5, 2013 recycled water grab sample that was taken at the prescribed frequency of daily. Coliform data for this day are being reported as 'Lab Accident' as a result of the culture tubes being accidentally discarded on day 3 of the analysis (Oct. 8) prior to final confirmed results being obtained.

The cause is being investigated.

#### **Chloride**

During 2013, the 30-day average value for chloride exceeded the permit limit of 260 mg/L on the following months: January, February, March, April, May, and June.

This increase in chloride concentration is under investigation.

Below is a graph showing the concentration of chloride in the treatment plant influent and recycled water at the SBWRP over time.

The graphical trending of the influent and recycled water chloride concentration indicates that there is increased chloride entering the treatment plant from the collection system. This increase was also observed for a short period during the winter of 2011.

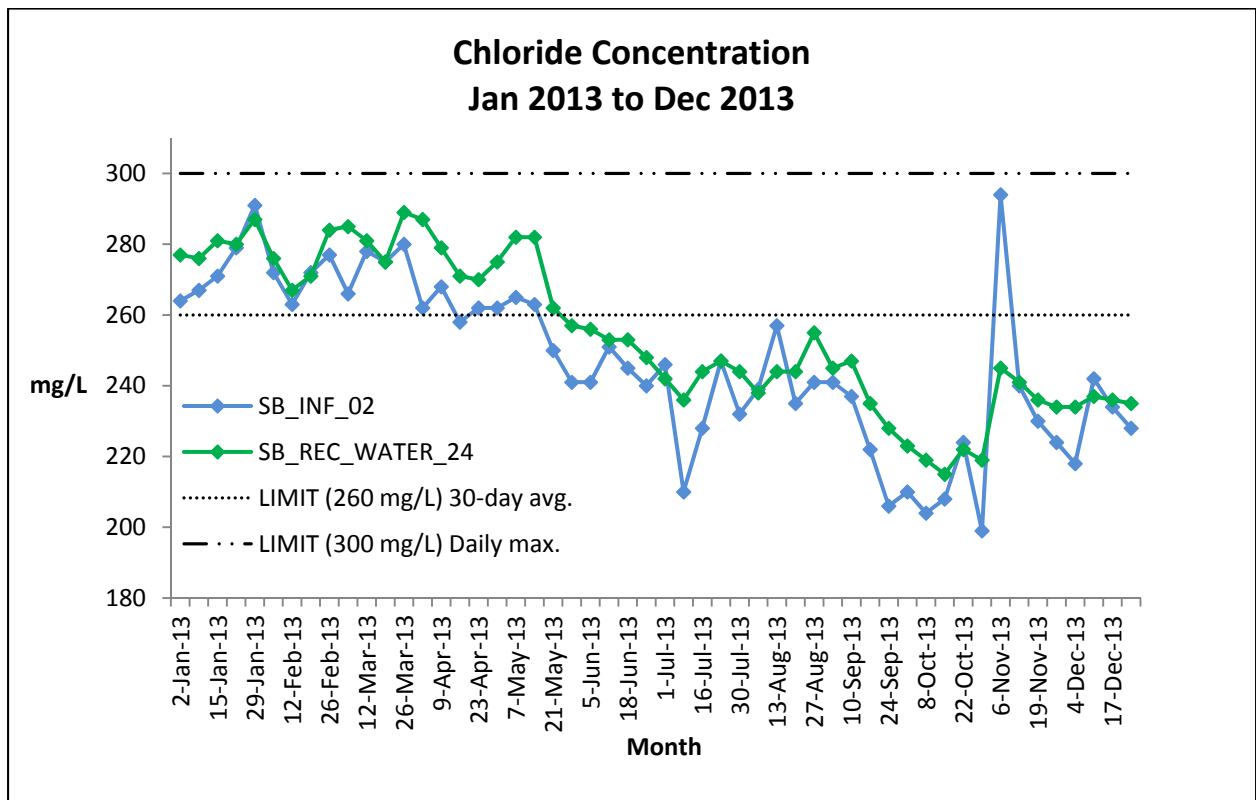

**Vector Control:**

The presence of midge flies has been an on-going issue with the potential to adversely affect effluent quality, primarily at the secondary clarifiers and tertiary filters. Plant staff members continue to rotate secondary clarifiers to disrupt midge fly larval production. Control measures also include lowering the water level of a secondary clarifier to expose the larvae adhering to the side walls so they can be hosed down and removed. Staff members also wash the sides of the filter during its backwash cycle to disrupt midge flies from reproducing. The efforts to gain full control over this problem continue.

**Engineering Projects:**

During 2013, the Engineering group for the Wastewater Treatment and Disposal Division (WWTD) provided engineer support for the plant. Their support is mainly on-demand (no resident engineer) so the on-going and completed projects identified below were accomplished by a combination of plant staff and by the WWTD engineering group.

1. Sludge Pumps Replacement Project – Pneumatics pumps will be replaced with motorized pumps to lower maintenance cost. Funding has been approved and the pumps and grinders have been ordered.
2. Service Air Compressor Replacement Project – The compressor currently uses large amounts of reclaimed water (RW) for cooling. When the sludge Pumps Replacement Project is completed, the compressor will be replaced with an air cooled type compressor eliminating the need to use



RW for cooling. Currently seeking funding to plan for replacement when the new sludge pump installation is completed.

3. Jockey Pump project - Pump was installed with Electrical and I&C pulling cable. Expect completion by Dec 2014.
4. Demineralization project (EDR) - Project is in the proposal phase to select Design Build team.

**Maintenance Report:**

**South Bay Maintenance Work Orders by Action**

Action	Work Order Count
EMERGENCY-CORRECTIVE	50
FABRICATION-PROACTIVE	0
INSPECTION-PROACTIVE	473
LUBRICATION-PROACTIVE	351
MOD/ENHANCE-PROACTIVE	0
OVERHAUL-CORRECTIVE	0
PREDICTIVE-PROACTIVE	10
REBUILD-PROACTIVE	0
ROUTINE MAINT-CORRECTIVE	812
ROUTINE MAINT-PROACTIVE	2685
SAFETY-CORRECTIVE	10
SAFETY-PROACTIVE	3
SP PROJ/CIP-PROACTIVE	4

**South Bay Maintenance Work Orders by Action**

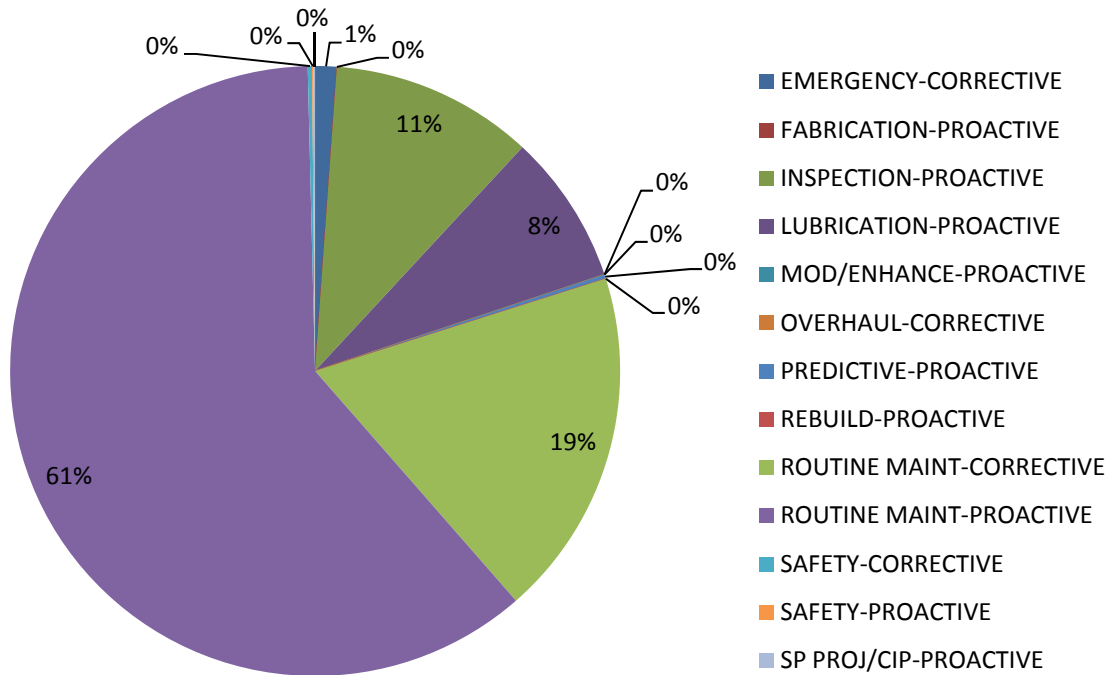

### South Bay Maintenance Work Orders by Crew

Crew	Work Order Count
CFM_BUILDING 78	78
CSM_MECHANICAL	11
CSM_PIPELINE	1
CSM_PAINTERS	4
CSM_RM	17
CSM_SHOP	13
PLM_ENGINE	54
SBM_ELECTRICAL	1432
SBM_MECHANICAL	2410
SB_ADMIN	32
SB_OPERATIONS	341
SB_PROCESS CONTROL	1
CS_ADMIN	0
PLM_MECH	1

### South Bay Maintenance Work Orders by Crew

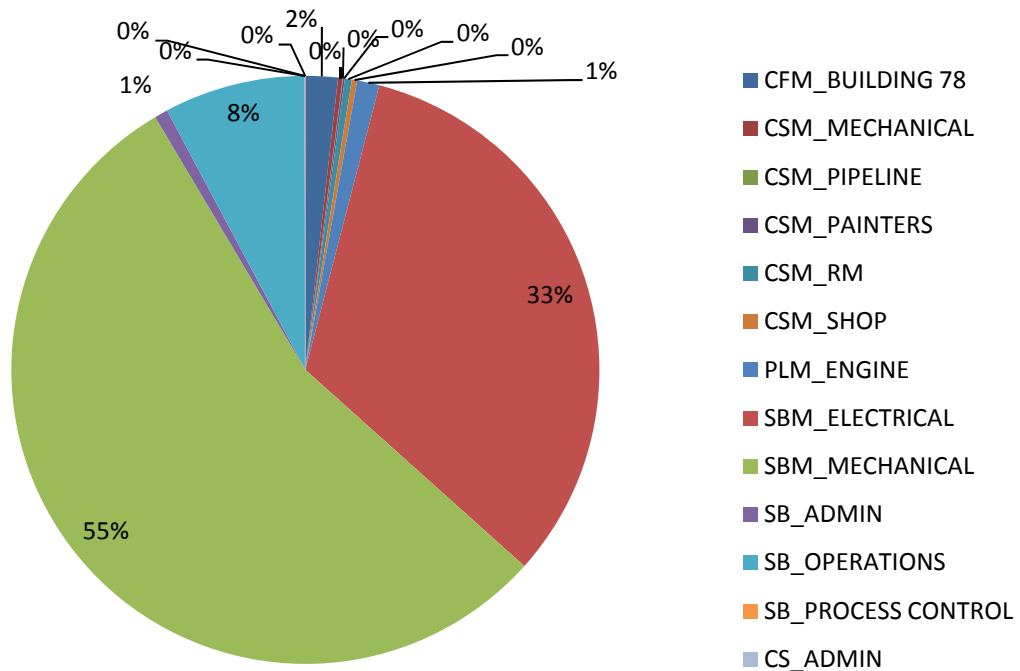

## H. Correlation of Results to Plant Conditions

In 2013 the amount of system flows treated at the SBWRP averaged over 8 million gallons per day

### Annual Totals

Year	SBWRP Influent (million gals)	SBWRP Discharge to South Bay Outfall (million gals)	SBWRP Distributed Recycled Water (million gals)	System Return Stream (million gals)	Net removed from Metro (million gals)
2013	2,948	1,171	1,172	590	2,343
2012	2,942	1,194	1,247	479	2,441
2011	3,001	1,288	1,177	505	2,465
2010	3,003	1,248	1,156	571	2,404
2009	3,050	958	1,501	564	2,459
2008	3,173	1,167	1,388	601	2,555
2007	3,158	1,467	1,101	527	2,568

Comparative flow data:

low stream	2010		2011		2012		2013	
	Daily Average	Annual Total	Daily Average	Annual Total	Daily Average	Annual Total	Daily Average	Annual Total
Influent	8.23	3,003	8.22	3,000	8.04	2,942	8.08	2,948
RW (Reclaimed Water) Produced	6.52	2,380	5.89	2,154	6.01	2,200	5.96	2,176
RW Distributed	3.15	1,156	3.22	1,177	3.4	1,247	3.20	1,172
RW In-plant use	0.85	311	0.97	353	0.86	316	0.77	282
Total reuse	4.0	1,467	4.19	1,530	4.26	1,563	3.97	1,454
Effluent to SBOO	3.43	1,248	3.54	1,288	3.27	1,194	3.22	1,171
Return to SMI	1.56	571	1.38	505	1.31	479	1.62	590

- II. Influent and Effluent Data Summary
  - A. Mass Emissions
  - B. Discharge Limits
  - C. Influent and Effluent Data Summaries
  - D. Influent and Effluent Graphs
  - E. Daily Values of Selected Parameters
  - F. Toxicity Bioassay

This page left blank intentionally.

A. Mass Emissions

Mass Emissions of Effluent Using 2013 Monthly Averages

DISCHARGE SPECIFICATIONS from NPDES Permit No. CA0109045/RWQCB Order No. R9-2013-0006 effective on January 1st 2007 with limits on pollutant discharges.

<b>Effluent Limitations Based on Secondary Treatment Standards</b>				
<b>Constituent/Property</b>	<b>Limit: Monthly Average (30 day) (lbs/day)</b>	<b>2013 Mass Emissions (lbs/day)<sup>[1]</sup></b>	<b>2013 Average Concentration</b>	<b>Units</b>
Flow (MGD)			<b>3.22</b>	MGD
<b>Total Suspended Solids</b>	3,750	<b>145</b>	<b>5.4</b>	mg/L
<b>BOD</b>	3,750	<b>322</b>	<b>12</b>	mg/L
Oil & Grease	3,130	54	2	mg/L

<b>Effluent Limitations Based on 2005 California Ocean Plan</b>				
<b>Constituent/Property</b>	<b>Limit: Daily Maximum (lbs/day)</b>	<b>2013 Mass Emissions (lbs/day)<sup>[1]</sup></b>	<b>2013 Average Concentration</b>	<b>Units</b>
Arsenic	350	0.019	0.7	ug/L
Cadmium	48	0	0	ug/L
Chromium	96	0.04	1.5	ug/L
Copper	120	0.3	11	ug/L
Lead	96	0.011	0.4	ug/L
Mercury	1.9	0.00005	0.002	ug/L
Nickel	240	0.19	7.11	ug/L
Selenium	720	0.017	0.62	ug/L
Silver	32	0	0	ug/L
Zinc	860	0.9	35	ug/L
Cyanide	48	0.027	0.001	mg/L
Residual Chlorine	96	1.3	0.05	mg/L
Ammonia	29,000	48.4	1.8	mg/L
Non-Chor. Phenols	1,400	0	0	ug/L
Chlorinated Phenols	48	0	0	ug/L
Endosulfan	0.21	0.00003	1	ng/L
Endrin	0.05	0.00	0	ng/L
hexachlorocyclohexanes *(HCH)	0.1	0.0	0	ng/L

\* (all as Lindane, the gamma isomer)

Effluent Limitations Based on 2005 California Ocean Plan				
Constituent/Property	Limit: Daily Maximum (lbs/day)	2013 Mass Emissions (lbs/day) <sup>[1]</sup>	2013 Average Concentration	Units
Acrolein	2,600	0	0	ug/L
Antimony	14,000	0.008	0.3	ug/L
Bis(2-chloroethoxy) methane	53	0	0	ug/L
Bis(2-chloroisopropyl) ether	14,000	0	0	ug/L
Chlorobenzene	6,800	0	0	ug/L
Chromium (III)	--	--	--	
di-n-butyl phthalate	42,000	0	0	ug/L
dichlorobenzenes	61,000	0	0	ug/L
1,1-dichloroethylene	11	0	0	ug/L
Diethyl phthalate	390,000	0	0	ug/L
Dimethyl phthalate	9,800,000	0	0	ug/L
4,6-dinitro-2-methylphenol	2,600	0	0	ug/L
2,4-dinitrophenol	480	0	0	ug/L
Ethylbenzene	49,000	0	0	ug/L
Fluoranthene	180	0	0	ug/L
Hexachlorocyclopentadiene	690	0	0	ug/L
Isophorone	70,000	0	0	ug/L
Nitrobenzene	59	0	0	ug/L
Thallium	24	0	0	ug/L
Toluene	1,000,000	0	0	ug/L
1,1,2,2-tetrachloroethane	27	0	0	ug/L
Tributyltin	0.02	0.00	0	ug/L
1,1,1-trichloroethane	6,500,000	0	0	ug/L
1,1,2-trichloroethane	110	0	0	ug/L
Acrylonitrile	1.2	0.0	0	ug/L
Aldrin	0.00026	0	0	ng/L
Benzene	71	0	0	ug/L
Benzidine	82,000	0	0	ug/L
Beryllium	0.39	0.00	0	ug/L
Bis(2-chloroethyl)ether	0.54	0.00	0	ug/L
Bis(2-ethylhexyl)phthalate	42	0	0	ug/L
Carbon Tetrachloride	11	0	0	ug/L
Chlordane	0.00027	0.00000	0	ng/L
Chlorodibromomethane	100	0	0	ug/L
Chloroform	1,500	0.01	0.2	ug/L
DDT	0.002	0.000	0	ng/L
1,4-dichlorobenzene	210	0	0	ug/L
3,3-dichlorobenzidine	0.097	0.000	0	ug/L
1,2-dichloroethane	330	0	0	ug/L
Dichlorobromomethane	74	0	0	ug/L
Dichloromethane (methylene chloride)	5,400	0	0	ug/L
1,3-dichloropropene	110	0	0	ug/L
Dieldrin	0.00048	0.00000	0	ng/L



Effluent Limitations Based on 2005 California Ocean Plan				
Constituent/Property	Limit: Daily Maximum (lbs/day)	2013 Mass Emissions (lbs/day) <sup>[1]</sup>	2013 Average Concentration	Units
2,4-dinitrotoluene	31	0	0	ug/L
1,2-diphenylhydrazine	1.9	0.0	0	ug/L
Halomethanes	1,500	0	0	ug/L
Heptachlor	0.0006	0.0000	0	ng/L
Heptachlor epoxide	0.00024	0.00000	0	ng/L
Hexachlorobenzene	0.0025	0.0000	0	ug/L
Hexachlorobutadiene	170	0	0	ug/L
Hexachloroethane	30	0	0	ug/L
N-nitrosodimethylamine	87	0	0	ug/L
N-nitrosodi-N-Propylamine	4.5	0.0	0	ug/L
N-nitrosodiphenylamine	30	0	0	ug/L
PAHs	0.11	0.00	0	ug/L
PCBs	0.00023	0.00000	0	ng/L
TCDD equivalents	0.000000048	0.000000000	0	pg/L
Tetrachloroethylene	24	0	0	ug/L
Toxaphene	0.0025	0.0000	0	ng/L
Trichloroethylene	320	0	0	ug/L
2,4,6-trichlorophenol	3.5	0.0	0	ug/L
Vinyl Chloride	430	0	0	ug/L

<sup>[1]</sup> Mass emissions is calculated assuming the density of effluent is 1. The mean constituent value and mean daily flow value over the year is used to compute the mass emissions, assuming that constant concentration over 365 days.

## B. Discharge Limits

DISCHARGE SPECIFICATIONS from NPDES Permit No. CA0109045/RWQCB Order No. R9-2013-0006 effective on April 4, 2013 with limits on pollutant discharges.

The discharge of effluent through the South Bay Ocean Outfall(E-001) shall maintain compliance with the following effluent limitations:

Effluent Limitations based on Secondary Treatment Standards						
Constituent	Units	6-month Median	30-day Average	7-Day Average	Daily Maximum	Instantaneous Maximum
Biochemical Oxygen Demand(BOD <sub>5</sub> )@ 20°C	mg/L		30	45		50
	lb/day		3,753	5,630		6,255
Total Suspended Solids	mg/L		30	45		50
	lb/day		3,753	5,630		6,255
pH	pH units	Within the limits of 6.0 - 9.0 at all times.				

Effluent Limitations based on 2005 California Ocean Plan						
Constituent	Units	6-month Median	30-day Average	7-Day Average	Daily Maximum	Instantaneous Maximum
Grease & Oil	mg/L		25	40		75
	lb/day		3,128	5,004		9,383
Settleable Solids	mL/L		1	1.5		3
Turbidity	NTU		75	100		225
Total Residual Chlorine(TRC)	mg/L	0.19			0.76	5.7
	lb/day	24			96	718
Copper, Total Recoverable	ug/L	98			960	2,700
	lb/day	12			120	340

Constituents that do not have reasonable potential or had inconclusive reasonable potential analysis results are referred to as performance goal constituents and are assigned the performance goals listed in the following table. Performance goal constituents shall also be monitored at E-001.

Performance Goals Based on 2005 California Ocean Plan				
Constituent	Units	6-month Median	Daily Maximum	Instantaneous Maximum
Arsenic	ug/L	480	2,800	7,400
	lb/day	60	350	920
Cadmium	ug/L	96	380	960
	lb/day	12	48	120
Chromium <sup>2</sup> (Hexavalent)	ug/L	190	760	1900
	lb/day	24	96	240
Lead	ug/L	190	760	1,900
	lb/day	24	96	240
Mercury	ug/L	3.8	15.0	38
	lb/day	0.47	1.9	4.8
Nickel	ug/L	480	1,900	4,800
	lb/day	60	240	600
Selenium	ug/L	1,400	5,700	14,000
	lb/day	180	720	1800
Silver	ug/L	52	250	650
	lb/day	6.5	32	82
Zinc	ug/L	1,200	6,900	18,000
	lb/day	140	860	2300
Cyanide	mg/L	0.096	0.38	0.96
	lb/day	12	48	120
Ammonia (expressed as Nitrogen)	mg/L	57	230	570
	lb/day	7200	29,000	72,000
Acute Toxicity	TUa		3.1 <sup>3</sup>	
Chronic Toxicity	TUc		96	
Phenolic Compounds(non-chlorinated)	ug/L	2,900	11,000	29,000
	lb/day	360	1400	3600
Chlorinated Phenolics	ug/L	96	380	960
	lb/day	12	48	120
Endosulfan	ng/L	860	1,700	2,600
	lb/day	0.11	0.21	0.32
Endrin	ng/L	190	380	570
	lb/day	0.024	0.048	0.072
HCH (hexachlorocyclohexanes)	ng/L	380	760	1,100
	lb/day	0.04	0.096	0.14
Radioactivity	Not to exceed limits specified in Title 17 California Code of Regulations Section 30253, Standards for Protection Against Radiation			

<sup>2</sup> Hexavalent Chromium limit met as Total Chromium.

<sup>3</sup> Permit shows  $2.9 \times 10^{-1}$  which reflects an apparent error in calculation as discussed with SDRWQCB staff. Correction to 3.1 TUa referenced by email of Friday, January 26, 2007 4:14 PM, From: Melissa Valdovinos [<mailto:mvaldovinos@waterboards.ca.gov>] To: Stebbins, Tim, [[Tstebbins@sandiego.gov](mailto:Tstebbins@sandiego.gov)]

Performance Goals Based on 2005 California Ocean Plan Continued		
Constituent	Monthly Average (30-Day)	
	ug/L	lbs/day
Acrolein	21,000	2600
Antimony	110,000	14,000
Bis(2-chloroethoxy) methane	420	53
Bis(2-chloroisopropyl) ether	110,000	14,000
Chlorobenzene	54,000	6800
Chromium (III) <sup>4</sup>	18,000,000	2,300,000
di-n-butyl phthalate	330,000	42,000
Dichlorobenzenes	490,000	61,000
Diethyl phthalate	3,100,000	390,000
Dimethyl phthalate	78,000,000	9,800,000
4,6-dinitro-2-methylphenol	21,000	2600
2,4-dinitrophenol	3800	480
Ethylbenzene	390,000	49,000
Fluoranthene	1,400	180
Hexachlorocyclopentadiene	5,500	690
Nitrobenzene	470	59
Thallium	190	24
Toluene	8,100,000	1,000,000
Tributyltin	0.13	0.020
1,1,1-trichloroethane	52,000,000	6,500,000
Acrylonitrile	9.6	1.2
Benzene	560	71
Benzidine	0.0066	82,000
Beryllium	3.1	0.39
Bis(2-chloroethyl)ether	4.3	0.54
Bis(2-ethylhexyl)phthalate	330	42
Carbon Tetrachloride	86	11
Chloroform	12,000	1500
1,4-dichlorobenzene	1,700	210
3,3-dichlorobenzidine	0.77	0.097
1,2-dichloroethane	2,700	330
1,1-dichloroethylene	86	11
Dichlorobormomethane	590	74
Dichloromethane	43,000	5400
1,3-dichloropropene	850	110
2,4-dinitrotoluene	250	31
1,2-diphenylhydrazine	15	1.9
Halomethanes	12,000	1500

Performance Goals Based on 2005 California Ocean Plan Continued		
Constituent	Monthly Average (30-Day)	
	ug/L	lbs/day
Hexachlorobenzene	0.02	0.0025
Hexachlorobutadiene	1,300	170
Hexachloroethane	240	30
Isophorone	70,000	8700
N-nitrosodimethylamine	700	87
N-nitrosodi-N-propylamine	36	4.5
N-nitrosodiphenylamine	240	30
PAHs	0.84	0.11
1,1,2,2-tetrachloroethane	220	27
Tetrachloroethylene	190	24
Trichloroethylene	2,600	320
1,1,2-trichloroethane	900	110
2,4,6-trichlorophenol	28	3.5
Vinyl Chloride	3,400	430
	ng/L	lbs/day
Aldrin	2.1	0.00026
Chlordane	2,200,000	0.00027
DDT	16	0.0026
Dieldrin	3.8	0.00048
Heptachlor	48	.00060
Heptachlor Epoxide	1.9	0.00024
PCBs	1.8	0.00023
Toxaphene	200	0.0025
	pg/L	lbs/day
TCDD equivalents	0.37	0.000000047

<sup>4</sup> Chromium (III) limit is met by Total Chromium.

## C. Influent and Effluent Data Summaries

The results of all analyses performed on the SBWRP influent and effluent are summarized in tables with monthly and annual averages (and in some cases annual totals) calculated. Data that have been reevaluated as discussed in Section 1.E are explicitly indicated. All other tables and charts include all data.

SOUTH BAY WATER RECLAMATION PLANT  
SEWAGE INFLUENT and EFFLUENT

Annual 2013

Biochemical Oxygen Demand Concentration  
(24-hour composite)

Month/ Units:	Influent Flow (MGD)	Daily Influent Value (mg/L)	Daily Influent Value (lbs/Day)	Effluent Flow (MGD)	Daily Effluent Value (mg/L)	Daily Effluent Value (lbs/Day)	Percent Removal BOD (%)
JANUARY -2013	8.02	324	21671	5.95	14	695	95.7
FEBRUARY -2013	8.17	291	19828	5.85	11	537	96.2
MARCH -2013	8.18	295	20125	4.97	15	622	94.9
APRIL -2013	8.22	308	21115	3.49	11	320	96.4
MAY -2013	8.21	317	21705	2.80	10	234	96.8
JUNE -2013	8.10	323	21820	1.09	15	136	95.4
JULY -2013	8.14	319	21656	1.14	15	143	95.3
AUGUST -2013	8.19	301	20560	0.89	8	59	97.3
SEPTEMBER-2013	8.05	301	20208	0.89	6	45	98.0
OCTOBER -2013	7.89	297	19543	2.24	16	299	94.6
NOVEMBER -2013	7.91	299	19725	4.34	6	217	98.0
DECEMBER -2013	7.86	322	21108	5.01	11	460	96.6
Average	8.08	308	20755	3.22	12	314	96.3

Annual Mass Emissions are calculated from monthly averages of flow for BOD, whereas Monthly Report average mass emissions are calculated from average daily mass emissions.

ND=not detected  
NA=not analyzed

SOUTH BAY WATER RECLAMATION PLANT  
SEWAGE INFLUENT and EFFLUENT

Annual 2013

Total Suspended Solids Concentration  
(24-hour composite)

Month/ Units:	Influent Flow (MGD)	Daily Influent TSS (mg/L)	Daily Influent VSS (mg/L)	Percent VSS (%)	Daily Influent Mass Emission (lbs/Day)
JANUARY -2013	8.02	279	249	89.2	18661
FEBRUARY -2013	8.17	268	237	88.4	18261
MARCH -2013	8.18	272	244	89.7	18556
APRIL -2013	8.22	276	243	88.0	18921
MAY -2013	8.21	291	256	88.0	19925
JUNE -2013	8.10	289	254	87.9	19523
JULY -2013	8.14	293	258	88.1	19891
AUGUST -2013	8.19	279	245	87.8	19057
SEPTEMBER-2013	8.05	300	267	89.0	20141
OCTOBER -2013	7.89	278	247	88.8	18293
NOVEMBER -2013	7.91	289	257	88.9	19065
DECEMBER -2013	7.86	311	284	91.3	20387
Average	8.08	285	253		19223

Total Suspended Solids Concentration  
(24-hour composite)

Month/ Units:	Effluent Flow (MGD)	Daily Effluent TSS (mg/L)	Daily Effluent VSS (mg/L)	Percent VSS (%)	Daily Effluent Mass Emission (lbs/Day)	Percent Removal TSS (%)	Percent Removal VSS (%)
JANUARY -2013	5.95	2.9	2.4	82.8	144	99.0	99.0
FEBRUARY -2013	5.85	3.3	2.8	84.8	161	98.8	98.8
MARCH -2013	4.97	6.4	5.7	89.1	265	97.6	97.7
APRIL -2013	3.49	5.4	4.7	87.0	157	98.0	98.1
MAY -2013	2.80	7.5	6.4	85.3	175	97.4	97.5
JUNE -2013	1.09	6.9	6.1	88.4	63	97.6	97.6
JULY -2013	1.14	6.2	5.4	87.1	59	97.9	97.9
AUGUST -2013	0.89	5.2	4.6	88.5	39	98.1	98.1
SEPTEMBER-2013	0.89	4.5	3.9	86.7	33	98.5	98.5
OCTOBER -2013	2.24	5.6	5.0	89.3	105	98.0	98.0
NOVEMBER -2013	4.34	4.6	3.9	84.8	166	98.4	98.5
DECEMBER -2013	5.01	6.6	6.1	92.4	276	97.9	97.9
Average	3.22	5.4	4.8		137	98.1	98.1

Annual Mass Emissions are calculated from monthly averages of flow and TSS, whereas Monthly Report average mass emissions are calculated from average daily mass emissions.

VSS= Volatile Suspended Solids  
TSS= Total Suspended Solids

SOUTH BAY WATER RECLAMATION PLANT

Annual 2013

Effluent to Ocean Outfall  
(SB\_OUTFALL\_01)

Analyte:	Flow	pH	Settleable Solids	Biochemical Oxygen Demand	Total Suspended Solids	Volatile Suspended Solids	Total Dissolved Solids
Units:	(mgd)	(pH)	(ml/L)	(mg/L)	(mg/L)	(mg/L)	(mg/L)
JANUARY -2013	5.95	7.45	ND	14	2.9	2.4	1010
FEBRUARY -2013	5.85	7.36	ND	11	3.3	2.8	962
MARCH -2013	4.97	7.33	ND	15	6.4	5.7	1010
APRIL -2013	3.49	7.35	ND	11	5.4	4.7	993
MAY -2013	2.80	7.37	ND	10	7.5	6.4	1080
JUNE -2013	1.09	7.43	ND	15	6.9	6.1	1110
JULY -2013	1.14	7.46	ND	15	6.2	5.4	1050
AUGUST -2013	0.89	7.43	ND	8	5.2	4.6	1170
SEPTEMBER-2013	0.89	7.46	ND	6	4.5	3.9	918
OCTOBER -2013	2.24	7.39	ND	16	5.6	5.0	975
NOVEMBER -2013	4.34	7.37	ND	6	4.6	3.9	879
DECEMBER -2013	5.01	7.39	ND	11	6.6	6.1	902
Average	3.22	7.40	ND	12	5.4	4.8	1005

Analyte:	Oil & Grease	Outfall Temperature	Residual Chlorine	Turbidity	Dissolved Oxygen
Units:	(mg/L)	(°C)	(mg/L)	(NTU)	(mg/L)
JANUARY -2013	1.8	22.2	0.05	2.17	2.89
FEBRUARY -2013	<1.2	21.9	0.05	2.36	2.31
MARCH -2013	2.4	22.8	0.05	3.31	2.91
APRIL -2013	<1.2	23.8	0.05	2.66	1.95
MAY -2013	1.2	24.4	0.05	3.45	4.80
JUNE -2013	1.9	25.9	0.06	3.60	2.72
JULY -2013	2.2	26.6	0.07	3.19	2.38
AUGUST -2013	2.1	27.1	0.06	2.25	2.51
SEPTEMBER-2013	2.7	27.3	0.05	2.21	3.25
OCTOBER -2013	2.2	25.9	0.05	3.03	1.74
NOVEMBER -2013	4.1	24.9	0.05	2.26	2.42
DECEMBER -2013	2.9	23.1	0.03	3.36	2.42
Average	2.0	24.7	0.05	2.82	2.69

ND=not detected  
NR=not required



SOUTH BAY WATER RECLAMATION PLANT

Annual 2013

Influent to Plant  
(SB\_INF\_02)

Analyte:	Flow	pH	Total Dissolved Solids	Biochemical Oxygen Demand	Total Suspended Solids	Volatile Suspended Solids	Turbidity
Units:	(mgd)	(pH)	(mg/L)	(mg/L)	(mg/L)	(mg/L)	(NTU)
JANUARY -2013	8.02	NR	1050	324	279	249	165
FEBRUARY -2013	8.17	7.78	1010	291	268	237	164
MARCH -2013	8.18	NR	1040	295	272	244	181
APRIL -2013	8.22	NR	1040	308	276	243	176
MAY -2013	8.21	7.70	1060	317	291	256	185
JUNE -2013	8.10	NR	1070	323	289	254	184
JULY -2013	8.14	NR	1050	319	293	258	190
AUGUST -2013	8.19	7.85	1090	301	279	245	183
SEPTEMBER-2013	8.05	NR	965	301	300	267	188
OCTOBER -2013	7.89	7.46	953	297	278	247	182
NOVEMBER -2013	7.91	NR	955	299	289	257	172
DECEMBER -2013	7.86	NR	986	322	311	284	183
Average	8.08	7.70	1022	308	285	253	179

ND=not detected  
NR=not required

SOUTH BAY WATER RECLAMATION PLANT  
ANNUAL SEWAGE

Trace Metals

Annual 2013

Analyte:	Aluminum	Aluminum	Antimony	Antimony	Arsenic	Arsenic
MAX MDL Units:	47 UG/L	47 UG/L	2.9 UG/L	2.9 UG/L	.4 UG/L	.4 UG/L
Source:	Influent	Effluent	Influent	Effluent	Influent	Effluent
Month/Limit:					2800	
=====						
JANUARY -2013	695	72	ND	ND	0.8	0.6
FEBRUARY -2013	1060	81	ND	ND	0.7	0.5
MARCH -2013	1050	65	ND	3.4	0.9	0.7
APRIL -2013	689	52	ND	ND	1.1	0.9
MAY -2013	968	137	ND	ND	1.1	0.7
JUNE -2013	569	59	ND	ND	1.0	0.8
JULY -2013	1010	104	3.7	ND	1.9	0.7
AUGUST -2013	771	95	ND	ND	1.3	0.7
SEPTEMBER-2013	1040	66	ND	ND	1.0	0.6
OCTOBER -2013	712	<47	6.1	ND	0.9	0.6
NOVEMBER -2013	429	ND	ND	ND	1.1	1.0
DECEMBER -2013	798	ND	ND	ND	1.0	0.6
=====						
AVERAGE	816	61	0.8	0.3	1.1	0.7

Analyte:	Barium	Barium	Beryllium	Beryllium	Boron	Boron
MAX MDL Units:	.039 UG/L	.039 UG/L	.022 UG/L	.022 UG/L	7 UG/L	7 UG/L
Source:	Influent	Effluent	Influent	Effluent	Influent	Effluent
Month/Limit:						
=====						
JANUARY -2013	65.2	48.2	ND	ND	284	288
FEBRUARY -2013	68.8	47.3	ND	ND	269	301
MARCH -2013	73.5	49.1	ND	ND	271	304
APRIL -2013	78.7	53.9	ND	ND	292	298
MAY -2013	100.0	63.6	ND	ND	299	331
JUNE -2013	94.5	59.1	ND	ND	286	296
JULY -2013	138.0	59.4	ND	ND	294	285
AUGUST -2013	90.3	59.0	ND	ND	281	292
SEPTEMBER-2013	93.9	52.9	ND	ND	321	289
OCTOBER -2013	87.0	61.6	0.060	ND	263	286
NOVEMBER -2013	104.0	54.6	ND	ND	233	254
DECEMBER -2013	97.1	58.8	ND	ND	304	274
=====						
AVERAGE	90.9	55.6	0.005	ND	283	292

Analyte:	Cadmium	Cadmium	Chromium	Chromium	Cobalt	Cobalt
MAX MDL Units:	.53 UG/L	.53 UG/L	1.2 UG/L	1.2 UG/L	.85 UG/L	.85 UG/L
Source:	Influent	Effluent	Influent	Effluent	Influent	Effluent
Month/Limit:	48		760			
=====						
JANUARY -2013	ND	ND	2.2	ND	NR	ND
FEBRUARY -2013	ND	ND	2.9	ND	ND	ND
MARCH -2013	ND	ND	2.4	ND	NR	ND
APRIL -2013	ND	ND	2.3	1.5	NR	ND
MAY -2013	ND	ND	3.3	<1.2	ND	ND
JUNE -2013	ND	ND	4.2	3.5	NR	ND
JULY -2013	ND	ND	10.0	<1.2	NR	ND
AUGUST -2013	ND	ND	4.8	ND	ND	ND
SEPTEMBER-2013	0.60	ND	5.0	2.0	NR	ND
OCTOBER -2013	ND	ND	3.1	2.8	ND	ND
NOVEMBER -2013	ND	ND	9.0	8.0	NR	ND
DECEMBER -2013	ND	ND	3.3	ND	NR	ND
=====						
AVERAGE	0.05	ND	4.4	1.5	ND	ND

ND= not detected  
NR= not requested

SOUTH BAY WATER RECLAMATION PLANT  
ANNUAL SEWAGE

Trace Metals

Annual 2013

Analyte:	Copper	Copper	Iron	Iron	Lead	Lead
MAX MDL Units:	2 UG/L	2 UG/L	37 UG/L	37 UG/L	2 UG/L	2 UG/L
Source:	Influent	Effluent	Influent	Effluent	Influent	Effluent
Month/Limit:	960				760	
=====						
JANUARY -2013	68	9	722	85	ND	ND
FEBRUARY -2013	94	13	625	104	3.0	2.0
MARCH -2013	103	11	920	ND	7.0	ND
APRIL -2013	108	14	612	42	ND	ND
MAY -2013	109	12	1010	95	ND	ND
JUNE -2013	71	10	697	60	2.0	ND
JULY -2013	105	11	11200	54	4.3	ND
AUGUST -2013	95	10	683	73	3.0	ND
SEPTEMBER-2013	124	10	776	52	ND	ND
OCTOBER -2013	97	9	584	64	ND	ND
NOVEMBER -2013	96	10	704	54	4.0	3.0
DECEMBER -2013	104	10	691	56	ND	ND
=====						
AVERAGE	98	11	1602	62	1.9	0.4

Analyte:	Manganese	Manganese	Mercury	Mercury	Molybdenum	Molybdenum
MAX MDL Units:	.24 UG/L	.24 UG/L	.005 UG/L	.005 UG/L	.89 UG/L	.89 UG/L
Source:	Influent	Effluent	Influent	Effluent	Influent	Effluent
Month/Limit:			15.00			
=====						
JANUARY -2013	89.1	50.6	0.102^	0.002^	NR	2.7
FEBRUARY -2013	83.4	25.3	0.096^	0.002^	6.3	5.2
MARCH -2013	94.0	19.8	0.093*	0.0014*	NR	3.3
APRIL -2013	104	20.9	0.131	ND	NR	1.7
MAY -2013	107	16.2	0.100	0.001	7.0	3.3
JUNE -2013	80.7	37.2	0.140	0.009	NR	2.0
JULY -2013	115	38.6	0.620	0.005	NR	3.6
AUGUST -2013	68.7	36.4	0.152	0.006	8.9	6.1
SEPTEMBER-2013	74.6	20.3	ND	ND	NR	4.7
OCTOBER -2013	75.6	14.7	0.109	ND	5.6	2.7
NOVEMBER -2013	55.3	23.6	0.034	ND	NR	4.2
DECEMBER -2013	64.2	13.0	0.214	ND	NR	2.4
=====						
AVERAGE	84.3	26.4	0.154	0.002	7.0	3.5

^ Analyzed by method CVAF\_1631E.

\*= This batch did not meet QC criteria for this analyte. The %RSD of the sample and the duplicate are 33% and 31% respectively, these values are above the acceptable limit of 25%.

ND= not detected  
NR= not requested

SOUTH BAY WATER RECLAMATION PLANT  
ANNUAL SEWAGE

Trace Metals

Annual 2013

Analyte:	Nickel	Nickel	Selenium	Selenium	Silver	Silver
MAX MDL Units:	.53 UG/L	.53 UG/L	.28 UG/L	.28 UG/L	.4 UG/L	.4 UG/L
Source:	Influent	Effluent	Influent	Effluent	Influent	Effluent
Month/Limit:	1900		5700		250	
=====	=====	=====	=====	=====	=====	=====
JANUARY -2013	3.84	4.80	1.07	0.33	ND	0.4
FEBRUARY -2013	5.21	4.66	1.32	0.39	0.5	ND
MARCH -2013	4.64	5.20	1.08	0.55	ND	ND
APRIL -2013	6.53	6.16	1.59	0.75	ND	ND
MAY -2013	7.93	5.73	1.60	0.60	0.5	ND
JUNE -2013	11.90	10.60	1.65	0.93	ND	ND
JULY -2013	19.40	6.38	2.28	0.84	ND	ND
AUGUST -2013	11.90	4.43	1.73	0.69	0.8	ND
SEPTEMBER-2013	13.60	11.60	1.50	0.53	0.5	ND
OCTOBER -2013	7.69	6.48	1.72	0.65	ND	ND
NOVEMBER -2013	16.80	14.20	0.97	0.61	1.0	ND
DECEMBER -2013	6.58	5.02	1.63	0.53	ND	ND
=====	=====	=====	=====	=====	=====	=====
AVERAGE	9.67	7.11	1.51	0.62	0.3	0.0

Analyte:	Thallium	Thallium	Vanadium	Vanadium	Zinc	Zinc
MAX MDL Units:	3.9 UG/L	3.9 UG/L	.64 UG/L	.64 UG/L	2.5 UG/L	2.5 UG/L
Source:	Influent	Effluent	Influent	Effluent	Influent	Effluent
Month/Limit:					6900	
=====	=====	=====	=====	=====	=====	=====
JANUARY -2013	ND	ND	NR	0.81	127	18.5
FEBRUARY -2013	ND	ND	2.2	ND	141	37.0
MARCH -2013	ND	ND	NR	0.80	160	40.3
APRIL -2013	ND	ND	NR	0.92	159	34.2
MAY -2013	ND	ND	2.4	<0.64	217	59.0
JUNE -2013	ND	ND	NR	1.40	166	30.1
JULY -2013	4.5	<3.9	NR	ND	352	25.6
AUGUST -2013	ND	ND	ND	ND	188	32.8
SEPTEMBER-2013	ND	ND	NR	ND	210	37.0
OCTOBER -2013	10.4	ND	2.1	0.85	172	41.7
NOVEMBER -2013	ND	ND	NR	0.70	162	28.0
DECEMBER -2013	4.9	ND	NR	1.21	174	35.5
=====	=====	=====	=====	=====	=====	=====
AVERAGE	1.7	0.0	1.7	0.56	186	35.0

ND= not detected  
NR= not requested

SOUTH BAY WATER RECLAMATION PLANT  
Annual Sewage Cations

Annual 2013

Analyte: MDL/Units: Source:	Calcium .04 mg/L		Magnesium .1 mg/L		Lithium .002 mg/L	
	INF	EFF	INF	EFF	INF	EFF
JANUARY -2013	65.0	68.8	35.2	35.7	0.022	0.020
FEBRUARY -2013	67.4	64.3	35.1	32.2	0.022	0.021
MARCH -2013	72.0	71.5	36.5	35.1	0.026	0.023
APRIL -2013	70.6	69.9	35.8	34.0	0.024	0.023
MAY -2013	69.4	71.9	35.0	34.5	0.030	0.022
JUNE -2013	71.7	72.3	34.5	33.5	0.032	0.029
JULY -2013	67.0	69.0	29.3	29.0	0.046	0.031
AUGUST -2013	61.8	65.8	29.6	28.8	0.034	0.032
SEPTEMBER-2013	62.9	64.8	30.7	30.2	0.029	0.027
OCTOBER -2013	58.5	64.2	24.7	26.0	0.039	0.035
NOVEMBER -2013	76.2	67.2	33.6	28.6	0.029	0.028
DECEMBER -2013	58.9	58.3	28.0	28.5	0.034	0.033
Average:	66.8	67.3	32.3	31.3	0.031	0.027

Analyte: MDL/Units: Source:	Sodium 1 mg/L		Potassium .3 mg/L	
	INF	EFF	INF	EFF
JANUARY -2013	197	207	19.5	17.9
FEBRUARY -2013	207	193	19.2	16.6
MARCH -2013	213	217	20.7	19.5
APRIL -2013	210	218	20.8	19.0
MAY -2013	214	218	20.8	19.1
JUNE -2013	210	208	22.3	20.4
JULY -2013	171	181	19.6	16.8
AUGUST -2013	184	181	21.3	18.4
SEPTEMBER-2013	173	178	16.3	15.5
OCTOBER -2013	164	173	17.0	16.3
NOVEMBER -2013	191	180	17.9	16.4
DECEMBER -2013	180	189	18.0	18.3
Average:	193	195	19.5	17.9

ND=not detected

INF= Influent

EFF= Effluent

SOUTH BAY WATER RECLAMATION PLANT  
ANNUAL SEWAGE

Anions

Annual 2013

Analyte:	Bromide	Bromide	Chloride	Chloride	Fluoride	Fluoride
MDL:	.1	.1	7	7	.05	.05
Units:	MG/L	MG/L	MG/L	MG/L	MG/L	MG/L
Source:	INFLUENT	EFFLUENT	INFLUENT	EFFLUENT	INFLUENT	EFFLUENT
=====	=====	=====	=====	=====	=====	=====
JANUARY -2013	0.5	0.6	274	276	0.50	0.49
FEBRUARY -2013	0.4	0.5	271	273	0.36	0.58
MARCH -2013	0.5	0.4	275	279	0.29	0.58
APRIL -2013	0.6	0.8	262	281	0.24	0.54
MAY -2013	0.4	0.5	255	273	0.33	0.29
JUNE -2013	0.3	0.4	244	250	0.39	0.55
JULY -2013	0.3	0.3	233	232	0.29	0.53
AUGUST -2013	0.6	0.3	243	236	0.28	0.51
SEPTEMBER-2013	0.3	0.3	227	241	0.23	0.57
OCTOBER -2013	0.2	0.2	209	221	0.16	0.50
NOVEMBER -2013	0.3	0.3	247	236	0.13	0.62
DECEMBER -2013	0.4	0.3	231	228	0.26	0.55
=====	=====	=====	=====	=====	=====	=====
AVERAGE	0.4	0.4	248	252	0.29	0.53

Analyte:	Nitrate	Nitrate	O-Phosphate	O-Phosphate	Sulfate	Sulfate
MDL:	.04	.04	.2	.2	9	9
Units:	MG/L	MG/L	MG/L	MG/L	MG/L	MG/L
Source:	INFLUENT	EFFLUENT	INFLUENT	EFFLUENT	INFLUENT	EFFLUENT
=====	=====	=====	=====	=====	=====	=====
JANUARY -2013	0.21	12.8	9.3	0.9	122	144
FEBRUARY -2013	0.28	29.1	10.2	4.2	121	139
MARCH -2013	0.08	32.8	9.9	4.6	120	143
APRIL -2013	0.96	31.7	10.7	2.3	121	146
MAY -2013	0.16	38.3	10.7	3.4	136	158
JUNE -2013	1.66	33.8	10.9	7.5	139	176
JULY -2013	0.50	18.3	11.1	3.7	127	192
AUGUST -2013	0.71	28.0	10.0	5.8	135	185
SEPTEMBER-2013	1.08	28.6	10.3	5.4	141	172
OCTOBER -2013	1.57	34.6	10.2	7.7	148	182
NOVEMBER -2013	2.63	32.9	10.6	8.4	138	175
DECEMBER -2013	0.26	38.5	11.1	7.8	148	169
=====	=====	=====	=====	=====	=====	=====
AVERAGE	0.84	30.0	10.4	5.1	133	165

ND= not detected

SOUTH BAY WATER RECLAMATION PLANT  
ANNUAL SEWAGE

Ammonia-Nitrogen and Total Cyanides

Annual 2013

Analyte:	Ammonia-N		Total	
	Ammonia-N	Ammonia-N	Cyanides	Cyanides
MDL/Units:	.3 MG/L	.3 MG/L	.002 MG/L	.002 MG/L
Source:	SB_INF_02	SB_OUTFALL_01	SB_INF_02	SB_OUTFALL_01
=====	=====	=====	=====	=====
JANUARY -2013	37.0	9.4	ND	ND
FEBRUARY -2013	31.9	1.7	ND	ND
MARCH -2013	35.8	ND	ND	0.002
APRIL -2013	35.3	ND	0.002	0.003
MAY -2013	35.6	ND	ND	ND
JUNE -2013	34.7	ND	0.002	ND
JULY -2013	39.6	9.3	0.003	ND
AUGUST -2013	38.9	0.5	ND	0.002
SEPTEMBER-2013	30.1	ND	ND	0.003
OCTOBER -2013	39.1	ND	ND	ND
NOVEMBER -2013	37.7	0.7	ND	0.002
DECEMBER -2013	38.8	ND	ND	0.002
=====	=====	=====	=====	=====
Average:	36.2	1.8	0.001	0.001

ND= not detected

SOUTH BAY WATER RECLAMATION PLANT  
Radioactivity  
Effluent to the Ocean (SB\_OUTFALL\_01)

Analyzed by: TestAmerica Laboratories Richland

Annual 2013

Month	Gross Alpha Radiation	Gross Beta Radiation
JANUARY -2013	4.1 ± 4.7	22.3 ± 5.4
FEBRUARY -2013	0.9 ± 4.9	18.6 ± 4.9
MARCH -2013	0.4 ± 3.7	21.6 ± 5.6
APRIL -2013	1.2 ± 4.6	17.6 ± 6.3
MAY -2013	2.3 ± 6.3	21.9 ± 7.7
JUNE -2013	1.2 ± 4.3	19.7 ± 5.9
JULY -2013	2.2 ± 4.7	22.7 ± 5.6
AUGUST -2013	1.2 ± 4.8	14.3 ± 5.8
SEPTEMBER-2013	-1.3 ± 5.0	19.3 ± 5.4
OCTOBER -2013	-0.1 ± 4.5	21.7 ± 6.5
NOVEMBER -2013	2.1 ± 5.8	24.2 ± 6.5
DECEMBER -2013	1.9 ± 4.3	21.0 ± 4.6
AVERAGE	1.3 ± 4.8	20.4 ± 5.8

Units in picocuries/liter (pCi/L)



SOUTH BAY WATER RECLAMATION PLANT  
SEWAGE ANNUAL - Chlorinated Pesticide Analysis

Annual 2013

Source:			EFF	EFF	EFF	EFF	EFF	EFF	EFF	EFF	EFF	EFF	EFF	EFF	EFF
Date:			JAN	FEB	MAR	APR	MAY	JUN	JUL	AUG	SEP	OCT	NOV	DEC	
Analyte	MDL	Units													Avg
Aldrin	8	NG/L	ND	ND	ND	ND	ND	ND	ND	ND	ND	ND	ND	ND	ND
Dieldrin	10	NG/L	ND	ND	ND	ND	ND	ND	ND	ND	ND	ND	ND	ND	ND
BHC, Alpha isomer	15	NG/L	ND	ND	ND	ND	ND	ND	ND	ND	ND	ND	ND	ND	ND
BHC, Beta isomer	20	NG/L	ND	ND	ND	ND	ND	ND	ND	ND	ND	ND	ND	ND	ND
BHC, Gamma isomer	15	NG/L	ND	ND	ND	ND	ND	ND	ND	ND	ND	ND	ND	ND	ND
BHC, Delta isomer	18	NG/L	ND	ND	ND	ND	ND	ND	ND	ND	ND	ND	ND	ND	ND
p,p-DDD	20	NG/L	ND	ND	ND	ND	ND	ND	ND	ND	ND	ND	ND	ND	ND
p,p-DDE	15	NG/L	ND	ND	ND	ND	ND	ND	ND	ND	ND	ND	ND	ND	ND
p,p-DDT	20	NG/L	ND	ND	ND	ND	ND	ND	ND	ND	ND	ND	ND	ND	ND
o,p-DDD	100	NG/L	ND	ND	ND	ND	ND	ND	ND	ND	ND	ND	ND	ND	ND
o,p-DDE	100	NG/L	ND	ND	ND	ND	ND	ND	ND	ND	ND	ND	ND	ND	ND
o,p-DDT	100	NG/L	ND	ND	ND	ND	ND	ND	ND	ND	ND	ND	ND	ND	ND
Heptachlor	15	NG/L	ND	ND	ND	ND	ND	ND	ND	ND	ND	ND	ND	ND	ND
Heptachlor epoxide	13	NG/L	ND	ND	ND	ND	ND	ND	ND	ND	ND	ND	ND	ND	ND
Alpha (cis) Chlordane	2	NG/L	ND	ND	ND	ND	ND	ND	ND	ND	ND	ND	ND	ND	ND
Gamma (trans) Chlordane	2	NG/L	ND	ND	ND	ND	ND	ND	ND	ND	ND	ND	ND	ND	ND
Alpha Chlordene		NG/L	NA	NA	NA	NA	NA	NA	NA	NA	NA	NA	NA	NA	NA
Gamma Chlordene		NG/L	NA	NA	NA	NA	NA	NA	NA	NA	NA	NA	NA	NA	NA
Oxychlordane	3	NG/L	ND	ND	ND	ND	ND	ND	ND	NA	ND	ND	ND	ND	ND
Trans Nonachlor	3	NG/L	ND	ND	ND	ND	ND	ND	ND	NA	ND	ND	ND	ND	ND
Cis Nonachlor	5	NG/L	ND	ND	ND	ND	ND	ND	ND	NA	ND	ND	ND	ND	ND
Alpha Endosulfan	15	NG/L	ND	ND	ND	ND	ND	ND	ND	ND	ND	ND	ND	ND	ND
Beta Endosulfan	10	NG/L	ND	ND	ND	ND	ND	ND	ND	ND	ND	ND	ND	8	1
Endosulfan Sulfate	15	NG/L	ND	ND	ND	ND	ND	ND	ND	ND	ND	ND	ND	ND	ND
Endrin	10	NG/L	ND	ND	ND	ND	ND	ND	ND	ND	ND	ND	ND	ND	ND
Endrin aldehyde	10	NG/L	ND	ND	ND	ND	ND	ND	ND	ND	ND	ND	ND	ND	ND
Mirex	10	NG/L	ND	ND	ND	ND	ND	ND	ND	ND	ND	ND	ND	ND	ND
Methoxychlor	18	NG/L	ND	ND	ND	ND	ND	ND	ND	ND	ND	ND	ND	ND	ND
Toxaphene	1300	NG/L	ND	ND	ND	ND	ND	ND	ND	ND	ND	ND	ND	ND	ND
PCB 1016	1300	NG/L	ND	ND	ND	ND	ND	ND	ND	ND	ND	ND	ND	ND	ND
PCB 1221	1300	NG/L	ND	ND	ND	ND	ND	ND	ND	ND	ND	ND	ND	ND	ND
PCB 1232	1300	NG/L	ND	ND	ND	ND	ND	ND	ND	ND	ND	ND	ND	ND	ND
PCB 1242	1300	NG/L	ND	ND	ND	ND	ND	ND	ND	ND	ND	ND	ND	ND	ND
PCB 1248	1300	NG/L	ND	ND	ND	ND	ND	ND	ND	ND	ND	ND	ND	ND	ND
PCB 1254	1300	NG/L	ND	ND	ND	ND	ND	ND	ND	ND	ND	ND	ND	ND	ND
PCB 1260	1300	NG/L	ND	ND	ND	ND	ND	ND	ND	ND	ND	ND	ND	ND	ND
PCB 1262	1300	NG/L	ND	ND	ND	ND	ND	ND	ND	ND	ND	ND	ND	ND	ND
Aldrin + Dieldrin	10	NG/L	0	0	0	0	0	0	0	0	0	0	0	0	0
Hexachlorocyclohexanes	20	NG/L	0	0	0	0	0	0	0	0	0	0	0	0	0
DDT and derivatives	100	NG/L	0	0	0	0	0	0	0	0	0	0	0	0	0
Chlordane + related cmpds.	3	NG/L	0	0	0	0	0	0	0	0	0	0	0	0	0
Polychlorinated biphenyls	1300	NG/L	0	0	0	0	0	0	0	0	0	0	0	0	0
Endosulfans	15	NG/L	0	0	0	0	0	0	0	0	0	0	0	8	1
Heptachlors	15	NG/L	0	0	0	0	0	0	0	0	0	0	0	0	0
Chlorinated Hydrocarbons	1300	NG/L	0	0	0	0	0	0	0	0	0	0	0	8	1

ND=not detected  
NA=not analyzed

Standards for alpha and gamma chlordene are no longer available in the U.S. for the analysis of these compounds.

SOUTH BAY WATER RECLAMATION PLANT  
SEWAGE ANNUAL - Chlorinated Pesticide Analysis

Annual 2013

Source:			INF	INF	INF	INF	INF
Date:			FEB	MAY	AUG	OCT	
Analyte	MDL	Units					Avg
=====	=====	=====	=====	=====	=====	=====	=====
Aldrin	8	NG/L	ND	ND	ND	ND	ND
Dieldrin	10	NG/L	ND	ND	ND	ND	ND
BHC, Alpha isomer	15	NG/L	ND	ND	ND	ND	ND
BHC, Beta isomer	20	NG/L	ND	ND	ND	ND	ND
BHC, Gamma isomer	15	NG/L	ND	ND	ND	ND	ND
BHC, Delta isomer	18	NG/L	ND	ND	ND	ND	ND
p,p-DDD	20	NG/L	ND	ND	ND	ND	ND
p,p-DDE	15	NG/L	DNQ3	ND	ND	DNQ4	2
p,p-DDT	20	NG/L	ND	ND	ND	ND	ND
o,p-DDD	100	NG/L	ND	ND	ND	ND	ND
o,p-DDE	100	NG/L	ND	ND	ND	ND	ND
o,p-DDT	100	NG/L	ND	ND	ND	ND	ND
Heptachlor	15	NG/L	ND	ND	ND	ND	ND
Heptachlor epoxide	13	NG/L	ND	ND	ND	ND	ND
Alpha (cis) Chlordane	2	NG/L	ND	ND	ND	ND	ND
Gamma (trans) Chlordane	2	NG/L	ND	ND	ND	ND	ND
Alpha Chlordene		NG/L	NA	NA	NA	NA	NA
Gamma Chlordene		NG/L	NA	NA	NA	NA	NA
Oxychlordane	3	NG/L	ND	ND	NA	ND	ND
Trans Nonachlor	3	NG/L	ND	ND	NA	ND	ND
Cis Nonachlor	5	NG/L	ND	ND	NA	ND	ND
Alpha Endosulfan	15	NG/L	ND	ND	ND	ND	ND
Beta Endosulfan	10	NG/L	ND	ND	ND	ND	ND
Endosulfan Sulfate	15	NG/L	ND	ND	ND	ND	ND
Endrin	10	NG/L	ND	ND	ND	ND	ND
Endrin aldehyde	10	NG/L	ND	ND	ND	ND	ND
Mirex	10	NG/L	ND	ND	ND	ND	ND
Methoxychlor	18	NG/L	ND	ND	ND	ND	ND
Toxaphene	1300	NG/L	ND	ND	ND	ND	ND
PCB 1016	1300	NG/L	ND	ND	ND	ND	ND
PCB 1221	1300	NG/L	ND	ND	ND	ND	ND
PCB 1232	1300	NG/L	ND	ND	ND	ND	ND
PCB 1242	1300	NG/L	ND	ND	ND	ND	ND
PCB 1248	1300	NG/L	ND	ND	ND	ND	ND
PCB 1254	1300	NG/L	ND	ND	ND	ND	ND
PCB 1260	1300	NG/L	ND	ND	ND	ND	ND
PCB 1262	1300	NG/L	ND	ND	ND	ND	ND
=====	=====	=====	=====	=====	=====	=====	=====
Aldrin + Dieldrin	10	NG/L	0	0	0	0	0
Hexachlorocyclohexanes	20	NG/L	0	0	0	0	0
DDT and derivatives	100	NG/L	3	0	0	4	2
Chlordane + related cmpds.	3	NG/L	0	0	0	0	0
Polychlorinated biphenyls	1300	NG/L	0	0	0	0	0
Endosulfans	15	NG/L	0	0	0	0	0
=====	=====	=====	=====	=====	=====	=====	=====
Heptachlors	15	NG/L	0	0	0	0	0
=====	=====	=====	=====	=====	=====	=====	=====
Chlorinated Hydrocarbons	1300	NG/L	3	0	0	4	2

ND=not detected

NA=not analyzed

DNQ= Detected not quantifiable, result value less than minimum level (ML) but greater or equal MDL.

Standards for alpha and gamma chlordene are no longer available in the U.S. for the analysis of these compounds.

SOUTH BAY WATER RECLAMATION PLANT  
Organophosphorus Pesticides EPA Method 614/622 (with additions)

INFLUENT(SB\_INF\_02) & EFFLUENT(SB\_OUTFALL\_01)

Annual 2013

Source:		Effluent	Effluent	Effluent	Influent	Influent
Date:		07-MAY-2013	09-MAY-2013	01-OCT-2013	07-MAY-2013	01-OCT-2013
Analyte	MDL Units	P661196	P661379	P677743	P661191	P677738
Demeton O	.15 UG/L	ND	ND	ND	ND	ND
Demeton S	.08 UG/L	ND	ND	ND	ND	ND
Diazinon	.03 UG/L	ND	ND	ND	ND	ND
Guthion	.15 UG/L	ND	ND	ND	ND	ND
Malathion	.03 UG/L	ND	ND	ND	DNQ0.1	ND
Parathion	.03 UG/L	ND	ND	ND	ND	ND
Dichlorvos	.05 UG/L	ND	ND	ND	ND	ND
Disulfoton	.02 UG/L	ND	ND	ND	ND	ND
Dimethoate	.04 UG/L	ND	ND	ND	ND	ND
Stirophos	.03 UG/L	ND	ND	ND	ND	ND
Coumaphos	.15 UG/L	ND	ND	ND	ND	ND
Chlorpyrifos	.03 UG/L	ND	ND	ND	ND	ND
Thiophosphorus Pesticides	.15 UG/L	0.0	0.0	0.0	0.0	0.0
Demeton -O, -S	.15 UG/L	0.0	0.0	0.0	0.0	0.0
Total Organophosphorus Pesticides	.15 UG/L	0.0	0.0	0.0	0.0	0.0

ND=not detected

DNQ= Detected not quantifiable, result value less than minimum level (ML) but greater or equal MDL.

SOUTH BAY WATER RECLAMATION PLANT  
ANNUAL SEWAGE - Tributyl Tin Analysis

Annual 2013

Source:			EFF	EFF	EFF	EFF	
Date:			FEB	MAY	AUG	OCT	
Analyte	MDL	Units					Average
=====	===	=====	=====	=====	=====	=====	=====
Dibutyltin	7	UG/L	ND	ND	ND	ND	ND
Monobutyltin	16	UG/L	ND	ND	ND	ND	ND
Tributyltin	2	UG/L	ND	ND	ND	ND	ND

Source:			INF	INF	INF	INF	
Date:			FEB	MAY	AUG	OCT	
Analyte	MDL	Units					Average
=====	===	=====	=====	=====	=====	=====	=====
Dibutyltin	7	UG/L	ND	ND	ND	ND	ND
Monobutyltin	16	UG/L	ND	ND	ND	ND	ND
Tributyltin	2	UG/L	ND	ND	ND	ND	ND

ND=not detected

SOUTH BAY WATER RECLAMATION PLANT  
SEWAGE ANNUAL - Acid Extractables

Annual 2013

Source:

EFFLUENT

Analyte	MDL	Units	JAN	FEB	MAR	APR	MAY	JUN	JUL	AUG	SEP	OCT	NOV	DEC	AVG
2-Chlorophenol	1.32	UG/L	ND	ND	ND	ND	ND	ND	ND	ND	ND	ND	ND	ND	ND
2,4-Dichlorophenol	1.01	UG/L	ND	ND	ND	ND	ND	ND	ND	ND	ND	ND	ND	ND	ND
4-Chloro-3-methylphenol	1.67	UG/L	ND	ND	ND	ND	ND	ND	ND	ND	ND	ND	ND	ND	ND
2,4,6-Trichlorophenol	1.65	UG/L	ND	ND	ND	ND	ND	ND	ND	ND	ND	ND	ND	ND	ND
Pentachlorophenol	1.12	UG/L	ND	ND	ND	ND	ND	ND	ND	ND	ND	ND	ND	ND	ND
Phenol	1.76	UG/L	ND	ND	ND	ND	ND	ND	ND	ND	ND	ND	ND	ND	ND
2-Nitrophenol	1.55	UG/L	ND	ND	ND	ND	ND	ND	ND	ND	ND	ND	ND	ND	ND
2,4-Dimethylphenol	2.01	UG/L	ND	ND	ND	ND	ND	ND	ND	ND	ND	ND	ND	ND	ND
2,4-Dinitrophenol	2.16	UG/L	ND	ND	ND	ND	ND	ND	ND	ND	ND	ND	ND	ND	ND
4-Nitrophenol	1.14	UG/L	ND	ND	ND	ND	ND	ND	ND	ND	ND	ND	ND	ND	ND
2-Methyl-4,6-dinitrophenol	1.52	UG/L	ND	ND	ND	ND	ND	ND	ND	ND	ND	ND	ND	ND	ND
Total Chlorinated Phenols	1.67	UG/L	0.0	0.0	0.0	0.0	0.0	0.0	0.0	0.0	0.0	0.0	0.0	0.0	0.0
Total Non-Chlorinated Phenols	2.16	UG/L	0.0	0.0	0.0	0.0	0.0	0.0	0.0	0.0	0.0	0.0	0.0	0.0	0.0
Total Phenols	2.16	UG/L	0.0	0.0	0.0	0.0	0.0	0.0	0.0	0.0	0.0	0.0	0.0	0.0	0.0

Additional analytes determined

2-Methylphenol	2.15	UG/L	ND	ND	ND	ND	ND	ND	ND	ND	ND	ND	ND	ND	ND
3-Methylphenol(4-MP is unresolved)		UG/L	NA	NA	NA	NA	NA	NA	NA	NA	NA	NA	NA	NA	NA
4-Methylphenol(3-MP is unresolved)	2.11	UG/L	ND	ND	ND	ND	ND	ND	ND	ND	ND	ND	ND	ND	ND
2,4,5-Trichlorophenol	1.66	UG/L	ND	ND	ND	ND	ND	ND	ND	ND	ND	ND	ND	ND	ND

Source:

INFLUENT

Analyte	MDL	Units	FEB	MAY	AUG	OCT	AVG
2-Chlorophenol	1.32	UG/L	ND	ND	ND	ND	ND
2,4-Dichlorophenol	1.01	UG/L	ND	ND	ND	ND	ND
4-Chloro-3-methylphenol	1.67	UG/L	ND	ND	ND	ND	ND
2,4,6-Trichlorophenol	1.65	UG/L	ND	ND	ND	ND	ND
Pentachlorophenol	1.12	UG/L	ND	ND	ND	ND	ND
Phenol	1.76	UG/L	28.3	46.9	51.2	59.5	46.5
2-Nitrophenol	1.55	UG/L	ND	ND	ND	ND	ND
2,4-Dimethylphenol	2.01	UG/L	ND	ND	ND	ND	ND
2,4-Dinitrophenol	2.16	UG/L	ND	ND	ND	ND	ND
4-Nitrophenol	1.14	UG/L	ND	ND	ND	ND	ND
2-Methyl-4,6-dinitrophenol	1.52	UG/L	ND	ND	ND	ND	ND
Total Chlorinated Phenols	1.67	UG/L	0.0	0.0	0.0	0.0	0.0
Total Non-Chlorinated Phenols	2.16	UG/L	28.3	46.9	51.2	59.5	46.5
Total Phenols	2.16	UG/L	28.3	46.9	51.2	59.5	46.5

Additional analytes determined

2-Methylphenol	2.15	UG/L	ND	ND	ND	ND	ND
3-Methylphenol(4-MP is unresolved)		UG/L	NA	NA	NA	NA	NA
4-Methylphenol(3-MP is unresolved)	2.11	UG/L	87.6	116.0	113.0	126.0	110.7
2,4,5-Trichlorophenol	1.66	UG/L	ND	ND	ND	ND	ND

ND=not detected  
NA=not analyzed

SOUTH BAY WATER RECLAMATION PLANT  
SEWAGE ANNUAL Priority Pollutants Base/Neutrals

Annual 2013

Source:	EFFLUENT						
Analyte	MDL	Units	FEB	MAY	AUG	OCT	AVG
=====							
Bis-(2-chloroethyl) ether	1.38	UG/L	ND	ND	ND	ND	ND
Bis-(2-chloroisopropyl) ether	1.16	UG/L	ND	ND	ND	ND	ND
N-nitrosodi-n-propylamine	1.16	UG/L	ND	ND	ND	ND	ND
Nitrobenzene	1.6	UG/L	ND	ND	ND	ND	ND
Hexachloroethane	1.32	UG/L	ND	ND	ND	ND	ND
Isophorone	1.53	UG/L	ND	ND	ND	ND	ND
Bis-(2-chloroethoxy) methane	1.01	UG/L	ND	ND	ND	ND	ND
1,2,4-Trichlorobenzene	1.52	UG/L	ND	ND	ND	ND	ND
Naphthalene	1.65	UG/L	ND	ND	ND	ND	ND
Hexachlorobutadiene	1.64	UG/L	ND	ND	ND	ND	ND
Hexachlorocyclopentadiene	1.25	UG/L	ND	ND	ND	ND	ND
Acenaphthylene	1.77	UG/L	ND	ND	ND	ND	ND
Dimethyl phthalate	1.44	UG/L	ND	ND	ND	ND	ND
2,6-Dinitrotoluene	1.53	UG/L	ND	ND	ND	ND	ND
Acenaphthene	1.8	UG/L	ND	ND	ND	ND	ND
2,4-Dinitrotoluene	1.36	UG/L	ND	ND	ND	ND	ND
Fluorene	1.61	UG/L	ND	ND	ND	ND	ND
4-Chlorophenyl phenyl ether	1.57	UG/L	ND	ND	ND	ND	ND
Diethyl phthalate	3.05	UG/L	ND	ND	ND	ND	ND
N-nitrosodiphenylamine	3.48	UG/L	ND	ND	ND	ND	ND
4-Bromophenyl phenyl ether	1.4	UG/L	ND	ND	ND	ND	ND
Hexachlorobenzene	1.48	UG/L	ND	ND	ND	ND	ND
Phenanthrene	1.34	UG/L	ND	ND	ND	ND	ND
Anthracene	1.29	UG/L	ND	ND	ND	ND	ND
Di-n-butyl phthalate	3.96	UG/L	ND	ND	ND	ND	ND
N-nitrosodimethylamine	1.27	UG/L	ND	ND	ND	ND	ND
Fluoranthene	1.33	UG/L	ND	ND	ND	ND	ND
Pyrene	1.43	UG/L	ND	ND	ND	ND	ND
Benzidine	1.52	UG/L	ND	ND	ND	ND	ND
Butyl benzyl phthalate	2.84	UG/L	ND	ND	ND	ND	ND
Chrysene	1.16	UG/L	ND	ND	ND	ND	ND
Benzo[a]anthracene	1.1	UG/L	ND	ND	ND	ND	ND
Bis-(2-ethylhexyl) phthalate	8.96	UG/L	ND	ND	ND	ND	ND
Di-n-octyl phthalate	1	UG/L	ND	ND	ND	ND	ND
3,3-Dichlorobenzidine	2.44	UG/L	ND	ND	ND	ND	ND
Benzo[k]fluoranthene	1.49	UG/L	ND	ND	ND	ND	ND
3,4-Benzo(b)fluoranthene	1.35	UG/L	ND	ND	ND	ND	ND
Benzo[a]pyrene	1.25	UG/L	ND	ND	ND	ND	ND
Indeno(1,2,3-CD)pyrene	1.14	UG/L	ND	ND	ND	ND	ND
Dibenzo(a,h)anthracene	1.01	UG/L	ND	ND	ND	ND	ND
Benzo[g,h,i]perylene	1.09	UG/L	ND	ND	ND	ND	ND
1,2-Diphenylhydrazine	1.37	UG/L	ND	ND	ND	ND	ND
=====							
Polynuc. Aromatic Hydrocarbons	1.77	UG/L	0.0	0.0	0.0	0.0	0.0
=====							
Base/Neutral Compounds	8.96	UG/L	0.0	0.0	0.0	0.0	0.0

Additional analytes determined

Analyte	MDL	Units	FEB	MAY	AUG	OCT	AVG
=====							
1-Methylnaphthalene	2.18	UG/L	ND	ND	ND	ND	ND
2-Methylnaphthalene	2.14	UG/L	ND	ND	ND	ND	ND
2,6-Dimethylnaphthalene	2.16	UG/L	ND	ND	ND	ND	ND
2,3,5-Trimethylnaphthalene	2.18	UG/L	ND	ND	ND	ND	ND
1-Methylphenanthrene	1.46	UG/L	ND	ND	ND	ND	ND
Benzo[e]pyrene	1.44	UG/L	ND	ND	ND	ND	ND
Perylene	1.41	UG/L	ND	ND	ND	ND	ND
Biphenyl	2.29	UG/L	ND	ND	ND	ND	ND

ND=not detected

SOUTH BAY WATER RECLAMATION PLANT  
SEWAGE ANNUAL Priority Pollutants Base/Neutrals

Annual 2013

Source:	INFLUENT						
Analyte	MDL	Units	FEB	MAY	AUG	OCT	AVG
Bis-(2-chloroethyl) ether	1.38	UG/L	ND	ND	ND	ND	ND
Bis-(2-chloroisopropyl) ether	1.16	UG/L	ND	ND	ND	ND	ND
N-nitrosodi-n-propylamine	1.16	UG/L	ND	ND	ND	ND	ND
Nitrobenzene	1.6	UG/L	ND	ND	ND	ND	ND
Hexachloroethane	1.32	UG/L	ND	ND	ND	ND	ND
Isophorone	1.53	UG/L	ND	ND	ND	ND	ND
Bis-(2-chloroethoxy) methane	1.01	UG/L	ND	ND	ND	ND	ND
1,2,4-Trichlorobenzene	1.52	UG/L	ND	ND	ND	ND	ND
Naphthalene	1.65	UG/L	ND	ND	ND	ND	ND
Hexachlorobutadiene	1.64	UG/L	ND	ND	ND	ND	ND
Hexachlorocyclopentadiene	1.25	UG/L	ND	ND	ND	ND	ND
Acenaphthylene	1.77	UG/L	ND	ND	ND	ND	ND
Dimethyl phthalate	1.44	UG/L	ND	ND	ND	ND	ND
2,6-Dinitrotoluene	1.53	UG/L	ND	ND	ND	ND	ND
Acenaphthene	1.8	UG/L	ND	ND	ND	ND	ND
2,4-Dinitrotoluene	1.36	UG/L	ND	ND	ND	ND	ND
Fluorene	1.61	UG/L	ND	ND	ND	ND	ND
4-Chlorophenyl phenyl ether	1.57	UG/L	ND	ND	ND	ND	ND
Diethyl phthalate	3.05	UG/L	5.2	5.2	5.2	7.0	5.7
N-nitrosodiphenylamine	3.48	UG/L	ND	ND	ND	ND	ND
4-Bromophenyl phenyl ether	1.4	UG/L	ND	ND	ND	ND	ND
Hexachlorobenzene	1.48	UG/L	ND	ND	ND	ND	ND
Phenanthrene	1.34	UG/L	ND	ND	ND	ND	ND
Anthracene	1.29	UG/L	ND	ND	ND	ND	ND
Di-n-butyl phthalate	3.96	UG/L	ND	ND	ND	ND	ND
N-nitrosodimethylamine	1.27	UG/L	ND	ND	ND	ND	ND
Fluoranthene	1.33	UG/L	ND	ND	ND	ND	ND
Pyrene	1.43	UG/L	ND	ND	ND	ND	ND
Benzidine	1.52	UG/L	ND	ND	ND	ND	ND
Butyl benzyl phthalate	2.84	UG/L	ND	ND	2.9	4.9	2.0
Chrysene	1.16	UG/L	ND	ND	ND	ND	ND
Benzo[a]anthracene	1.1	UG/L	ND	ND	ND	ND	ND
Bis-(2-ethylhexyl) phthalate	8.96	UG/L	10.2	16.3	ND	11.3	9.5
Di-n-octyl phthalate	1	UG/L	ND	ND	ND	ND	ND
3,3-Dichlorobenzidine	2.44	UG/L	ND	ND	ND	ND	ND
Benzo[k]fluoranthene	1.49	UG/L	ND	ND	ND	ND	ND
3,4-Benzo(b)fluoranthene	1.35	UG/L	ND	ND	ND	ND	ND
Benzo[a]pyrene	1.25	UG/L	ND	ND	ND	ND	ND
Indeno(1,2,3-CD)pyrene	1.14	UG/L	ND	ND	ND	ND	ND
Dibenzo(a,h)anthracene	1.01	UG/L	ND	ND	ND	ND	ND
Benzo[g,h,i]perylene	1.09	UG/L	ND	ND	ND	ND	ND
1,2-Diphenylhydrazine	1.37	UG/L	ND	ND	ND	ND	ND
Polynuc. Aromatic Hydrocarbons	1.77	UG/L	0.0	0.0	0.0	0.0	0.0
Base/Neutral Compounds	8.96	UG/L	15.4	21.5	8.1	23.2	17.1

Additional analytes determined

1-Methylnaphthalene	2.18	UG/L	ND	ND	ND	ND	ND
2-Methylnaphthalene	2.14	UG/L	ND	ND	ND	ND	ND
2,6-Dimethylnaphthalene	2.16	UG/L	ND	ND	ND	ND	ND
2,3,5-Trimethylnaphthalene	2.18	UG/L	ND	ND	ND	ND	ND
1-Methylphenanthrene	1.46	UG/L	ND	ND	ND	ND	ND
Benzo[e]pyrene	1.44	UG/L	ND	ND	ND	ND	ND
Perylene	1.41	UG/L	ND	ND	ND	ND	ND
Biphenyl	2.29	UG/L	ND	ND	ND	ND	ND

ND=not detected

SOUTH BAY WATER RECLAMATION PLANT  
SEWAGE ANNUAL Priority Pollutants Purgeables

Annual 2013

Source:	EFFLUENT						
Analyte	MDL	Units	FEB	MAY	AUG	OCT	AVG
Dichlorodifluoromethane	.66	UG/L	ND	ND	ND	ND	ND
Chloromethane	.5	UG/L	ND	ND	ND	ND	ND
Vinyl chloride	.4	UG/L	ND	ND	ND	ND	ND
Bromomethane	.7	UG/L	ND	ND	ND	ND	ND
Chloroethane	.9	UG/L	ND	ND	ND	ND	ND
Trichlorofluoromethane	.3	UG/L	ND	ND	ND	ND	ND
Acrolein	1.3	UG/L	ND	ND	ND	ND	ND
1,1-Dichloroethane	.4	UG/L	ND	ND	ND	ND	ND
Methylene chloride	.3	UG/L	ND	ND	ND	ND	ND
trans-1,2-dichloroethene	.6	UG/L	ND	ND	ND	ND	ND
1,1-Dichloroethene	.4	UG/L	ND	ND	ND	ND	ND
Acrylonitrile	.7	UG/L	ND	ND	ND	ND	ND
Chloroform	.2	UG/L	ND	ND	ND	DNQ <sup>0.8</sup>	0.2
1,1,1-Trichloroethane	.4	UG/L	ND	ND	ND	ND	ND
Carbon tetrachloride	.4	UG/L	ND	ND	ND	ND	ND
Benzene	.4	UG/L	ND	ND	ND	ND	ND
1,2-Dichloroethane	.5	UG/L	ND	ND	ND	ND	ND
Trichloroethene	.7	UG/L	ND	ND	ND	ND	ND
1,2-Dichloropropane	.3	UG/L	ND	ND	ND	ND	ND
Bromodichloromethane	.5	UG/L	ND	ND	ND	ND	ND
2-Chloroethylvinyl ether	1.1	UG/L	ND	ND	ND	ND	ND
cis-1,3-dichloropropene	.3	UG/L	ND	ND	ND	ND	ND
Toluene	.4	UG/L	ND	ND	ND	ND	ND
trans-1,3-dichloropropene	.5	UG/L	ND	ND	ND	ND	ND
1,1,2-Trichloroethane	.5	UG/L	ND	ND	ND	ND	ND
Tetrachloroethene	1.1	UG/L	ND	ND	ND	ND	ND
Dibromochloromethane	.6	UG/L	ND	ND	ND	ND	ND
Chlorobenzene	.4	UG/L	ND	ND	ND	ND	ND
Ethylbenzene	.3	UG/L	ND	ND	ND	ND	ND
Bromoform	.5	UG/L	ND	ND	ND	ND	ND
1,1,2,2-Tetrachloroethane	.5	UG/L	ND	ND	ND	ND	ND
1,3-Dichlorobenzene	.5	UG/L	ND	ND	ND	ND	ND
1,4-Dichlorobenzene	.4	UG/L	0.49*	ND	ND	ND	ND
1,2-Dichlorobenzene	.4	UG/L	ND	ND	ND	ND	ND
1,2,4-Trichlorobenzene	1.52	UG/L	ND	ND	ND	ND	ND
Halomethane Purgeable Cmpnds	.7	UG/L	0.0	0.0	0.0	0.0	0.0
Total Dichlorobenzenes	.5	UG/L	0.0	0.0	0.0	0.0	0.0
Total Chloromethanes	.5	UG/L	0.0	0.0	0.0	0.0	0.2
Purgeable Compounds	1.3	UG/L	0.0	0.0	0.0	0.0	0.2

Additional analytes determined

Methyl Iodide	.6	UG/L	ND	ND	ND	ND	ND
Carbon disulfide	.6	UG/L	ND	ND	ND	ND	ND
Acetone	4.5	UG/L	ND	ND	ND	ND	ND
Allyl chloride	.6	UG/L	ND	ND	ND	ND	ND
Methyl tert-butyl ether	.4	UG/L	ND	ND	ND	ND	ND
Chloroprene	.4	UG/L	ND	ND	ND	ND	ND
1,2-Dibromoethane	.3	UG/L	ND	ND	ND	ND	ND
2-Butanone	6.3	UG/L	ND	ND	ND	ND	ND
Methyl methacrylate	.8	UG/L	ND	ND	ND	ND	ND
2-Nitropropane	12	UG/L	ND	ND	ND	ND	ND
4-Methyl-2-pentanone	1.3	UG/L	ND	ND	ND	ND	ND
meta,para xylenes	.6	UG/L	ND	ND	ND	ND	ND
ortho-xylene	.4	UG/L	ND	ND	ND	ND	ND
Isopropylbenzene	.3	UG/L	ND	ND	ND	ND	ND
Styrene	.3	UG/L	ND	ND	ND	ND	ND
Benzyl chloride	1.1	UG/L	ND	ND	ND	ND	ND

ND= not detected

\*= Blank did not meet QC criteria for this analyte due to contamination. Result is not used in computations.  
DNQ= (Detected but not quantified). Estimated analyte concentration below calibration range.



SOUTH BAY WATER RECLAMATION PLANT  
SEWAGE ANNUAL Priority Pollutants Purgeables

Annual 2013

Source:	INFLUENT						
Analyte	MDL	Units	FEB	MAY	AUG	OCT	AVG
Dichlorodifluoromethane	.66	UG/L	ND	ND	ND	ND	ND
Chloromethane	.5	UG/L	ND	ND	ND	ND	ND
Vinyl chloride	.4	UG/L	ND	ND	ND	ND	ND
Bromomethane	.7	UG/L	ND	ND	ND	ND	ND
Chloroethane	.9	UG/L	ND	ND	ND	ND	ND
Trichlorofluoromethane	.3	UG/L	ND	ND	ND	ND	ND
Acrolein	1.3	UG/L	ND	ND	ND	ND	ND
1,1-Dichloroethane	.4	UG/L	ND	ND	ND	ND	ND
Methylene chloride	.3	UG/L	ND	ND	2.5	ND	0.6
trans-1,2-dichloroethene	.6	UG/L	ND	ND	ND	ND	ND
1,1-Dichloroethene	.4	UG/L	ND	ND	ND	ND	ND
Acrylonitrile	.7	UG/L	ND	ND	ND	ND	ND
Chloroform	.2	UG/L	2.9	7.0	1.7	1.2	3.2
1,1,1-Trichloroethane	.4	UG/L	ND	ND	ND	ND	ND
Carbon tetrachloride	.4	UG/L	ND	ND	ND	ND	ND
Benzene	.4	UG/L	ND	ND	ND	ND	ND
1,2-Dichloroethane	.5	UG/L	ND	ND	ND	ND	ND
Trichloroethene	.7	UG/L	ND	ND	ND	ND	ND
1,2-Dichloropropane	.3	UG/L	ND	ND	ND	ND	ND
Bromodichloromethane	.5	UG/L	ND	ND	ND	ND	ND
2-Chloroethylvinyl ether	1.1	UG/L	ND	ND	ND	ND	ND
cis-1,3-dichloropropene	.3	UG/L	ND	ND	ND	ND	ND
Toluene	.4	UG/L	DNQ	0.6DNQ	1.0DNQ	0.6	2.8
trans-1,3-dichloropropene	.5	UG/L	ND	ND	ND	ND	ND
1,1,2-Trichloroethane	.5	UG/L	ND	ND	ND	ND	ND
Tetrachloroethene	1.1	UG/L	ND	ND	ND	ND	ND
Dibromochloromethane	.6	UG/L	ND	ND	ND	ND	ND
Chlorobenzene	.4	UG/L	ND	ND	ND	ND	ND
Ethylbenzene	.3	UG/L	ND	ND	ND	ND	ND
Bromoform	.5	UG/L	ND	ND	ND	ND	ND
1,1,2,2-Tetrachloroethane	.5	UG/L	ND	ND	ND	ND	ND
1,3-Dichlorobenzene	.5	UG/L	ND	ND	ND	ND	ND
1,4-Dichlorobenzene	.4	UG/L	0.43*DNQ	0.7DNQ	0.5DNQ	0.5	0.6
1,2-Dichlorobenzene	.4	UG/L	ND	ND	ND	ND	ND
1,2,4-Trichlorobenzene	1.52	UG/L	ND	ND	ND	ND	ND
Halomethane Purgeable Cmpnds	.7	UG/L	0.0	0.0	0.0	0.0	0.0
Total Dichlorobenzenes	.5	UG/L	0.0	0.0	0.0	0.0	0.0
Total Chloromethanes	.5	UG/L	2.9	7.0	4.2	1.2	3.8
Purgeable Compounds	1.3	UG/L	2.9	7.0	4.2	4.5	3.8

Additional analytes determined

Methyl Iodide	.6	UG/L	ND	ND	ND	ND	ND
Carbon disulfide	.6	UG/L	1.5	1.6	1.2	1.7	1.5
Acetone	4.5	UG/L	135	175	196	290	199
Allyl chloride	.6	UG/L	ND	ND	ND	ND	ND
Methyl tert-butyl ether	.4	UG/L	ND	ND	ND	ND	ND
Chloroprene	.4	UG/L	ND	ND	ND	ND	ND
1,2-Dibromoethane	.3	UG/L	ND	ND	ND	ND	ND
2-Butanone	6.3	UG/L	ND	ND	ND	ND	ND
Methyl methacrylate	.8	UG/L	ND	ND	ND	ND	ND
2-Nitropropane	12	UG/L	ND	ND	ND	ND	ND
4-Methyl-2-pentanone	1.3	UG/L	ND	ND	ND	ND	ND
meta,para xylenes	.6	UG/L	ND	ND	ND	ND	ND
ortho-xylene	.4	UG/L	ND	ND	ND	ND	ND
Isopropylbenzene	.3	UG/L	ND	ND	ND	ND	ND
Styrene	.3	UG/L	ND	ND	DNQ	0.9	ND
Benzyl chloride	1.1	UG/L	ND	ND	ND	ND	ND

ND= not detected

\*= Blank did not meet QC criteria for this analyte due to contamination. Result is not used in computations.  
DNQ= (Detected but not quantified). Estimated analyte concentration below calibration range.

SOUTH BAY WATER RECLAMATION PLANT  
Annual Sewage Dioxin and Furan Analysis

Annual 2013

Source:				INF	INF	INF	INF
Date:				JAN	FEB	MAR	APR
Analyte	MDL	Units	Equiv	P645024	P649723	P653745	P657281
2,3,7,8-tetra CDD	.26	PG/L	1.000	ND	ND	ND	ND
1,2,3,7,8-penta CDD	.277	PG/L	0.500	ND	ND	ND	ND
1,2,3,4,7,8_hexa_CDD	.482	PG/L	0.100	ND	ND	ND	ND
1,2,3,6,7,8-hexa CDD	.484	PG/L	0.100	ND	DNQ3.26	ND	ND
1,2,3,7,8,9-hexa CDD	.479	PG/L	0.100	ND	ND	ND	ND
1,2,3,4,6,7,8-hepta CDD	.53	PG/L	0.010	DNQ17	29.2	DNQ13.5	DNQ24.8
octa CDD	1.4	PG/L	0.001	170	130	140	170
2,3,7,8-tetra CDF	.257	PG/L	0.100	ND	ND	ND	ND
1,2,3,7,8-penta CDF	.335	PG/L	0.050	ND	ND	ND	ND
2,3,4,7,8-penta CDF	.34	PG/L	0.500	ND	ND	ND	ND
1,2,3,4,7,8-hexa CDF	.284	PG/L	0.100	ND	ND	ND	ND
1,2,3,6,7,8-hexa CDF	.281	PG/L	0.100	ND	ND	ND	DNQ2.29
1,2,3,7,8,9-hexa CDF	.348	PG/L	0.100	ND	ND	ND	ND
2,3,4,6,7,8-hexa CDF	.294	PG/L	0.100	ND	ND	ND	ND
1,2,3,4,6,7,8-hepta CDF	.295	PG/L	0.010	DNQ3.2	DNQ2.08	ND	DNQ3.95
1,2,3,4,7,8,9-hepta CDF	.397	PG/L	0.010	ND	ND	ND	ND
octa CDF	.738	PG/L	0.001	DNQ9.5	DNQ5.77	DNQ5.86	DNQ7.85

Source:				INF	INF	INF	INF
Date:				MAY	JUN	JUL	AUG
Analyte	MDL	Units	Equiv	P661191	P664260	P667869	P671198
2,3,7,8-tetra CDD	.26	PG/L	1.000	ND	ND	ND	ND
1,2,3,7,8-penta CDD	.277	PG/L	0.500	ND	ND	ND	ND
1,2,3,4,7,8_hexa_CDD	.482	PG/L	0.100	ND	ND	ND	ND
1,2,3,6,7,8-hexa CDD	.484	PG/L	0.100	ND	ND	DNQ6.14	ND
1,2,3,7,8,9-hexa CDD	.479	PG/L	0.100	ND	ND	ND	ND
1,2,3,4,6,7,8-hepta CDD	.53	PG/L	0.010	24.3	DNQ13.1	39.6	DNQ23
octa CDD	1.4	PG/L	0.001	210	130	180	130
2,3,7,8-tetra CDF	.257	PG/L	0.100	ND	ND	DNQ0.484	ND
1,2,3,7,8-penta CDF	.335	PG/L	0.050	ND	ND	DNQ1.37	ND
2,3,4,7,8-penta CDF	.34	PG/L	0.500	ND	ND	ND	ND
1,2,3,4,7,8-hexa CDF	.284	PG/L	0.100	ND	ND	ND	ND
1,2,3,6,7,8-hexa CDF	.281	PG/L	0.100	ND	DNQ1.61	DNQ2.18	ND
1,2,3,7,8,9-hexa CDF	.348	PG/L	0.100	ND	ND	ND	ND
2,3,4,6,7,8-hexa CDF	.294	PG/L	0.100	ND	ND	ND	ND
1,2,3,4,6,7,8-hepta CDF	.295	PG/L	0.010	ND	DNQ3.34	DNQ3.81	DNQ3.54
1,2,3,4,7,8,9-hepta CDF	.397	PG/L	0.010	ND	ND	ND	ND
octa CDF	.738	PG/L	0.001	DNQ8.2	DNQ8.7	DNQ9.13	DNQ6.93

Source:				INF	INF	INF	INF
Date:				SEP	OCT	NOV	DEC
Analyte	MDL	Units	Equiv	P674733	P677738	P682966	P686553
2,3,7,8-tetra CDD	.26	PG/L	1.000	ND	ND	ND	ND
1,2,3,7,8-penta CDD	.277	PG/L	0.500	ND	ND	ND	ND
1,2,3,4,7,8_hexa_CDD	.482	PG/L	0.100	ND	ND	ND	ND
1,2,3,6,7,8-hexa CDD	.484	PG/L	0.100	ND	ND	ND	ND
1,2,3,7,8,9-hexa CDD	.479	PG/L	0.100	ND	ND	ND	ND
1,2,3,4,6,7,8-hepta CDD	.53	PG/L	0.010	DNQ14	DNQ14.8	DNQ19.9	DNQ21.3
octa CDD	1.4	PG/L	0.001	DNQ142	120	130	150
2,3,7,8-tetra CDF	.257	PG/L	0.100	ND	ND	ND	ND
1,2,3,7,8-penta CDF	.335	PG/L	0.050	ND	ND	ND	ND
2,3,4,7,8-penta CDF	.34	PG/L	0.500	ND	ND	ND	ND
1,2,3,4,7,8-hexa CDF	.284	PG/L	0.100	ND	ND	ND	ND
1,2,3,6,7,8-hexa CDF	.281	PG/L	0.100	DNQ1.87	ND	ND	DNQ3.55
1,2,3,7,8,9-hexa CDF	.348	PG/L	0.100	ND	ND	ND	ND
2,3,4,6,7,8-hexa CDF	.294	PG/L	0.100	ND	ND	ND	ND
1,2,3,4,6,7,8-hepta CDF	.295	PG/L	0.010	DNQ2.48	DNQ2.35	DNQ2.65	DNQ4.57
1,2,3,4,7,8,9-hepta CDF	.397	PG/L	0.010	ND	ND	ND	ND
octa CDF	.738	PG/L	0.001	DNQ5.84	DNQ6.87	DNQ4.86	DNQ8.58

ND= not detected  
DNQ= (Detected but not quantified). Estimated analyte concentration below calibration range.

SOUTH BAY WATER RECLAMATION PLANT  
Annual Sewage Dioxin and Furan Analysis

Annual 2013

Analyte	MDL	Units	Equiv	EFF	EFF	EFF	EFF
				JAN P645028	FEB P649728	MAR P653749	APR P657285
2,3,7,8-tetra CDD	.26	PG/L	1.000	ND	ND	ND	ND
1,2,3,7,8-penta CDD	.277	PG/L	0.500	ND	ND	ND	ND
1,2,3,4,7,8-hexa_CDD	.482	PG/L	0.100	ND	ND	ND	ND
1,2,3,6,7,8-hexa CDD	.484	PG/L	0.100	ND	ND	ND	ND
1,2,3,7,8,9-hexa CDD	.479	PG/L	0.100	ND	ND	ND	ND
1,2,3,4,6,7,8-hepta CDD	.53	PG/L	0.010	ND	ND	ND	ND
octa CDD	1.4	PG/L	0.001	ND	DNQ5.19	ND	DNQ6.8
2,3,7,8-tetra CDF	.257	PG/L	0.100	ND	ND	ND	ND
1,2,3,7,8-penta CDF	.335	PG/L	0.050	ND	ND	ND	ND
2,3,4,7,8-penta CDF	.34	PG/L	0.500	ND	ND	ND	ND
1,2,3,4,7,8-hexa CDF	.284	PG/L	0.100	ND	ND	ND	ND
1,2,3,6,7,8-hexa CDF	.281	PG/L	0.100	ND	ND	ND	ND
1,2,3,7,8,9-hexa CDF	.348	PG/L	0.100	ND	ND	ND	ND
2,3,4,6,7,8-hexa CDF	.294	PG/L	0.100	ND	ND	ND	ND
1,2,3,4,6,7,8-hepta CDF	.295	PG/L	0.010	ND	ND	ND	ND
1,2,3,4,7,8,9-hepta CDF	.397	PG/L	0.010	ND	ND	ND	ND
octa CDF	.738	PG/L	0.001	ND	ND	ND	ND

Analyte	MDL	Units	Equiv	EFF	EFF	EFF	EFF
				MAY	JUN P664264	JUL P667873	AUG P671203
2,3,7,8-tetra CDD	.26	PG/L	1.000	ND	ND	ND	ND
1,2,3,7,8-penta CDD	.277	PG/L	0.500	ND	ND	ND	ND
1,2,3,4,7,8-hexa_CDD	.482	PG/L	0.100	ND	ND	ND	ND
1,2,3,6,7,8-hexa CDD	.484	PG/L	0.100	ND	ND	ND	ND
1,2,3,7,8,9-hexa CDD	.479	PG/L	0.100	ND	ND	ND	ND
1,2,3,4,6,7,8-hepta CDD	.53	PG/L	0.010	ND	ND	ND	ND
octa CDD	1.4	PG/L	0.001	ND	DNQ9.77	ND	ND
2,3,7,8-tetra CDF	.257	PG/L	0.100	ND	ND	ND	ND
1,2,3,7,8-penta CDF	.335	PG/L	0.050	ND	ND	ND	ND
2,3,4,7,8-penta CDF	.34	PG/L	0.500	ND	ND	ND	ND
1,2,3,4,7,8-hexa CDF	.284	PG/L	0.100	ND	ND	ND	ND
1,2,3,6,7,8-hexa CDF	.281	PG/L	0.100	ND	ND	ND	ND
1,2,3,7,8,9-hexa CDF	.348	PG/L	0.100	ND	ND	ND	ND
2,3,4,6,7,8-hexa CDF	.294	PG/L	0.100	ND	ND	ND	ND
1,2,3,4,6,7,8-hepta CDF	.295	PG/L	0.010	ND	ND	ND	ND
1,2,3,4,7,8,9-hepta CDF	.397	PG/L	0.010	ND	ND	ND	ND
octa CDF	.738	PG/L	0.001	ND	ND	ND	ND

Analyte	MDL	Units	Equiv	EFF	EFF	EFF	EFF
				SEP P674737	OCT P677743	NOV P682970	DEC P686557
2,3,7,8-tetra CDD	.26	PG/L	1.000	ND	ND	ND	ND
1,2,3,7,8-penta CDD	.277	PG/L	0.500	ND	ND	ND	ND
1,2,3,4,7,8-hexa_CDD	.482	PG/L	0.100	ND	ND	ND	ND
1,2,3,6,7,8-hexa CDD	.484	PG/L	0.100	ND	ND	ND	ND
1,2,3,7,8,9-hexa CDD	.479	PG/L	0.100	ND	ND	ND	ND
1,2,3,4,6,7,8-hepta CDD	.53	PG/L	0.010	DNQ1.13	ND	ND	ND
octa CDD	1.4	PG/L	0.001	DNQ5.2	DNQ5.44	ND	ND
2,3,7,8-tetra CDF	.257	PG/L	0.100	ND	ND	ND	ND
1,2,3,7,8-penta CDF	.335	PG/L	0.050	ND	ND	ND	ND
2,3,4,7,8-penta CDF	.34	PG/L	0.500	ND	ND	ND	ND
1,2,3,4,7,8-hexa CDF	.284	PG/L	0.100	ND	ND	ND	ND
1,2,3,6,7,8-hexa CDF	.281	PG/L	0.100	ND	ND	ND	ND
1,2,3,7,8,9-hexa CDF	.348	PG/L	0.100	ND	ND	ND	ND
2,3,4,6,7,8-hexa CDF	.294	PG/L	0.100	ND	ND	ND	ND
1,2,3,4,6,7,8-hepta CDF	.295	PG/L	0.010	ND	ND	ND	ND
1,2,3,4,7,8,9-hepta CDF	.397	PG/L	0.010	ND	ND	ND	ND
octa CDF	.738	PG/L	0.001	ND	ND	ND	ND

ND= not detected

DNQ= (Detected but not quantified). Estimated analyte concentration below calibration range.

SOUTH BAY WATER RECLAMATION PLANT  
Annual Sewage Dioxin and Furan Analysis

Annual 2013

Source:				INF	INF	INF	INF
Date:				TCCD	TCCD	TCCD	TCCD
Analyte	MDL	Units	Equiv	JAN P645024	FEB P649723	MAR P653745	APR P657281
2,3,7,8-tetra CDD	.26	PG/L	1.000	ND	ND	ND	ND
1,2,3,7,8-penta CDD	.277	PG/L	0.500	ND	ND	ND	ND
1,2,3,4,7,8_hexa_CDD	.482	PG/L	0.100	ND	ND	ND	ND
1,2,3,6,7,8-hexa CDD	.484	PG/L	0.100	ND	DNQ0.326	ND	ND
1,2,3,7,8,9-hexa CDD	.479	PG/L	0.100	ND	ND	ND	ND
1,2,3,4,6,7,8-hepta CDD	.53	PG/L	0.010	DNQ0.17	0.292	DNQ0.135	DNQ0.248
octa CDD	1.4	PG/L	0.001	0.17	0.13	0.14	0.17
2,3,7,8-tetra CDF	.257	PG/L	0.100	ND	ND	ND	ND
1,2,3,7,8-penta CDF	.335	PG/L	0.050	ND	ND	ND	ND
2,3,4,7,8-penta CDF	.34	PG/L	0.500	ND	ND	ND	ND
1,2,3,4,7,8-hexa CDF	.284	PG/L	0.100	ND	ND	ND	ND
1,2,3,6,7,8-hexa CDF	.281	PG/L	0.100	ND	ND	ND	DNQ0.229
1,2,3,7,8,9-hexa CDF	.348	PG/L	0.100	ND	ND	ND	ND
2,3,4,6,7,8-hexa CDF	.294	PG/L	0.100	ND	ND	ND	ND
1,2,3,4,6,7,8-hepta CDF	.295	PG/L	0.010	DNQ0.032	DNQ0.021	ND	DNQ0.04
1,2,3,4,7,8,9-hepta CDF	.397	PG/L	0.010	ND	ND	ND	ND
octa CDF	.738	PG/L	0.001	DNQ0.01	DNQ0.006	DNQ0.006	DNQ0.008

Source:				INF	INF	INF	INF
Date:				TCCD	TCCD	TCCD	TCCD
Analyte	MDL	Units	Equiv	MAY P661191	JUN P664260	JUL P667869	AUG P671198
2,3,7,8-tetra CDD	.26	PG/L	1.000	ND	ND	ND	ND
1,2,3,7,8-penta CDD	.277	PG/L	0.500	ND	ND	ND	ND
1,2,3,4,7,8_hexa_CDD	.482	PG/L	0.100	ND	ND	ND	ND
1,2,3,6,7,8-hexa CDD	.484	PG/L	0.100	ND	ND	DNQ0.614	ND
1,2,3,7,8,9-hexa CDD	.479	PG/L	0.100	ND	ND	ND	ND
1,2,3,4,6,7,8-hepta CDD	.53	PG/L	0.010	0.243	DNQ0.131	0.396	DNQ0.23
octa CDD	1.4	PG/L	0.001	0.21	0.13	0.18	0.13
2,3,7,8-tetra CDF	.257	PG/L	0.100	ND	ND	DNQ0.048	ND
1,2,3,7,8-penta CDF	.335	PG/L	0.050	ND	ND	DNQ0.069	ND
2,3,4,7,8-penta CDF	.34	PG/L	0.500	ND	ND	ND	ND
1,2,3,4,7,8-hexa CDF	.284	PG/L	0.100	ND	ND	ND	ND
1,2,3,6,7,8-hexa CDF	.281	PG/L	0.100	ND	DNQ0.161	DNQ0.218	ND
1,2,3,7,8,9-hexa CDF	.348	PG/L	0.100	ND	ND	ND	ND
2,3,4,6,7,8-hexa CDF	.294	PG/L	0.100	ND	ND	ND	ND
1,2,3,4,6,7,8-hepta CDF	.295	PG/L	0.010	ND	DNQ0.033	DNQ0.038	DNQ0.035
1,2,3,4,7,8,9-hepta CDF	.397	PG/L	0.010	ND	ND	ND	ND
octa CDF	.738	PG/L	0.001	DNQ0.008	DNQ0.009	DNQ0.009	DNQ0.007

Source:				INF	INF	INF	INF
Date:				TCCD	TCCD	TCCD	TCCD
Analyte	MDL	Units	Equiv	SEP P674733	OCT P677738	NOV P682966	DEC P686553
2,3,7,8-tetra CDD	.26	PG/L	1.000	ND	ND	ND	ND
1,2,3,7,8-penta CDD	.277	PG/L	0.500	ND	ND	ND	ND
1,2,3,4,7,8_hexa_CDD	.482	PG/L	0.100	ND	ND	ND	ND
1,2,3,6,7,8-hexa CDD	.484	PG/L	0.100	ND	ND	ND	ND
1,2,3,7,8,9-hexa CDD	.479	PG/L	0.100	ND	ND	ND	ND
1,2,3,4,6,7,8-hepta CDD	.53	PG/L	0.010	DNQ0.14	DNQ0.148	DNQ0.199	DNQ0.213
octa CDD	1.4	PG/L	0.001	DNQ0.142	0.12	0.13	0.15
2,3,7,8-tetra CDF	.257	PG/L	0.100	ND	ND	ND	ND
1,2,3,7,8-penta CDF	.335	PG/L	0.050	ND	ND	ND	ND
2,3,4,7,8-penta CDF	.34	PG/L	0.500	ND	ND	ND	ND
1,2,3,4,7,8-hexa CDF	.284	PG/L	0.100	ND	ND	ND	ND
1,2,3,6,7,8-hexa CDF	.281	PG/L	0.100	DNQ0.187	ND	ND	DNQ0.355
1,2,3,7,8,9-hexa CDF	.348	PG/L	0.100	ND	ND	ND	ND
2,3,4,6,7,8-hexa CDF	.294	PG/L	0.100	ND	ND	ND	ND
1,2,3,4,6,7,8-hepta CDF	.295	PG/L	0.010	DNQ0.025	DNQ0.024	DNQ0.027	DNQ0.046
1,2,3,4,7,8,9-hepta CDF	.397	PG/L	0.010	ND	ND	ND	ND
octa CDF	.738	PG/L	0.001	DNQ0.006	DNQ0.007	DNQ0.005	DNQ0.009

ND= not detected  
DNQ= (Detected but not quantified). Estimated analyte concentration below calibration range.

SOUTH BAY WATER RECLAMATION PLANT  
Annual Sewage Dioxin and Furan Analysis

Annual 2013

Source:				EFF	EFF	EFF	EFF
Date:				TCCD	TCCD	TCCD	TCCD
Analyte	MDL	Units	Equiv	JAN	FEB	MAR	APR
				P645028	P649728	P653749	P657285
2,3,7,8-tetra CDD	.26	PG/L	1.000	ND	ND	ND	ND
1,2,3,7,8-penta CDD	.277	PG/L	0.500	ND	ND	ND	ND
1,2,3,4,7,8_hexa_CDD	.482	PG/L	0.100	ND	ND	ND	ND
1,2,3,6,7,8-hexa CDD	.484	PG/L	0.100	ND	ND	ND	ND
1,2,3,7,8,9-hexa CDD	.479	PG/L	0.100	ND	ND	ND	ND
1,2,3,4,6,7,8-hepta CDD	.53	PG/L	0.010	ND	ND	ND	ND
octa CDD	1.4	PG/L	0.001	ND	DNQ0.005	ND	DNQ0.007
2,3,7,8-tetra CDF	.257	PG/L	0.100	ND	ND	ND	ND
1,2,3,7,8-penta CDF	.335	PG/L	0.050	ND	ND	ND	ND
2,3,4,7,8-penta CDF	.34	PG/L	0.500	ND	ND	ND	ND
1,2,3,4,7,8-hexa CDF	.284	PG/L	0.100	ND	ND	ND	ND
1,2,3,6,7,8-hexa CDF	.281	PG/L	0.100	ND	ND	ND	ND
1,2,3,7,8,9-hexa CDF	.348	PG/L	0.100	ND	ND	ND	ND
2,3,4,6,7,8-hexa CDF	.294	PG/L	0.100	ND	ND	ND	ND
1,2,3,4,6,7,8-hepta CDF	.295	PG/L	0.010	ND	ND	ND	ND
1,2,3,4,7,8,9-hepta CDF	.397	PG/L	0.010	ND	ND	ND	ND
octa CDF	.738	PG/L	0.001	ND	ND	ND	ND

Source:				EFF	EFF	EFF	EFF
Date:				TCCD	TCCD	TCCD	TCCD
Analyte	MDL	Units	Equiv	MAY	JUN	JUL	AUG
					P664264	P667873	P671203
2,3,7,8-tetra CDD	.26	PG/L	1.000	ND	ND	ND	ND
1,2,3,7,8-penta CDD	.277	PG/L	0.500	ND	ND	ND	ND
1,2,3,4,7,8_hexa_CDD	.482	PG/L	0.100	ND	ND	ND	ND
1,2,3,6,7,8-hexa CDD	.484	PG/L	0.100	ND	ND	ND	ND
1,2,3,7,8,9-hexa CDD	.479	PG/L	0.100	ND	ND	ND	ND
1,2,3,4,6,7,8-hepta CDD	.53	PG/L	0.010	ND	ND	ND	ND
octa CDD	1.4	PG/L	0.001	ND	DNQ0.01	ND	ND
2,3,7,8-tetra CDF	.257	PG/L	0.100	ND	ND	ND	ND
1,2,3,7,8-penta CDF	.335	PG/L	0.050	ND	ND	ND	ND
2,3,4,7,8-penta CDF	.34	PG/L	0.500	ND	ND	ND	ND
1,2,3,4,7,8-hexa CDF	.284	PG/L	0.100	ND	ND	ND	ND
1,2,3,6,7,8-hexa CDF	.281	PG/L	0.100	ND	ND	ND	ND
1,2,3,7,8,9-hexa CDF	.348	PG/L	0.100	ND	ND	ND	ND
2,3,4,6,7,8-hexa CDF	.294	PG/L	0.100	ND	ND	ND	ND
1,2,3,4,6,7,8-hepta CDF	.295	PG/L	0.010	ND	ND	ND	ND
1,2,3,4,7,8,9-hepta CDF	.397	PG/L	0.010	ND	ND	ND	ND
octa CDF	.738	PG/L	0.001	ND	ND	ND	ND

Source:				EFF	EFF	EFF	EFF
Date:				TCCD	TCCD	TCCD	TCCD
Analyte	MDL	Units	Equiv	SEP	OCT	NOV	DEC
				P674737	P677743	P682970	P686557
2,3,7,8-tetra CDD	.26	PG/L	1.000	ND	ND	ND	ND
1,2,3,7,8-penta CDD	.277	PG/L	0.500	ND	ND	ND	ND
1,2,3,4,7,8_hexa_CDD	.482	PG/L	0.100	ND	ND	ND	ND
1,2,3,6,7,8-hexa CDD	.484	PG/L	0.100	ND	ND	ND	ND
1,2,3,7,8,9-hexa CDD	.479	PG/L	0.100	ND	ND	ND	ND
1,2,3,4,6,7,8-hepta CDD	.53	PG/L	0.010	DNQ0.011	ND	ND	ND
octa CDD	1.4	PG/L	0.001	DNQ0.005	DNQ0.005	ND	ND
2,3,7,8-tetra CDF	.257	PG/L	0.100	ND	ND	ND	ND
1,2,3,7,8-penta CDF	.335	PG/L	0.050	ND	ND	ND	ND
2,3,4,7,8-penta CDF	.34	PG/L	0.500	ND	ND	ND	ND
1,2,3,4,7,8-hexa CDF	.284	PG/L	0.100	ND	ND	ND	ND
1,2,3,6,7,8-hexa CDF	.281	PG/L	0.100	ND	ND	ND	ND
1,2,3,7,8,9-hexa CDF	.348	PG/L	0.100	ND	ND	ND	ND
2,3,4,6,7,8-hexa CDF	.294	PG/L	0.100	ND	ND	ND	ND
1,2,3,4,6,7,8-hepta CDF	.295	PG/L	0.010	ND	ND	ND	ND
1,2,3,4,7,8,9-hepta CDF	.397	PG/L	0.010	ND	ND	ND	ND
octa CDF	.738	PG/L	0.001	ND	ND	ND	ND

ND= not detected

DNQ= (Detected but not quantified). Estimated analyte concentration below calibration range.

## **D. Influent and Effluent Graphs**

Graphs of monthly averages for permit parameters with measurable concentration averages.

Where possible, the influent and effluent values of a given parameter have been included on the same graph so that removals and other relationships are readily apparent. Please note that many of the graphs are on expanded scales. Please note that many of the graphs are on expanded scales where the y-axes (concentration) do not start at zero, but instead are scaled to highlight the range of concentrations where variation takes place. These expanded scales make differences and some trends obvious that might normally not be noticed; however, they also may inadvertently place more weight on relatively minor changes or trends than deserved. Frequent reference to the scales and the actual differences in concentrations is therefore necessary.

## 2013 South Bay Water Reclamation Plant Monthly Averages

### Flows

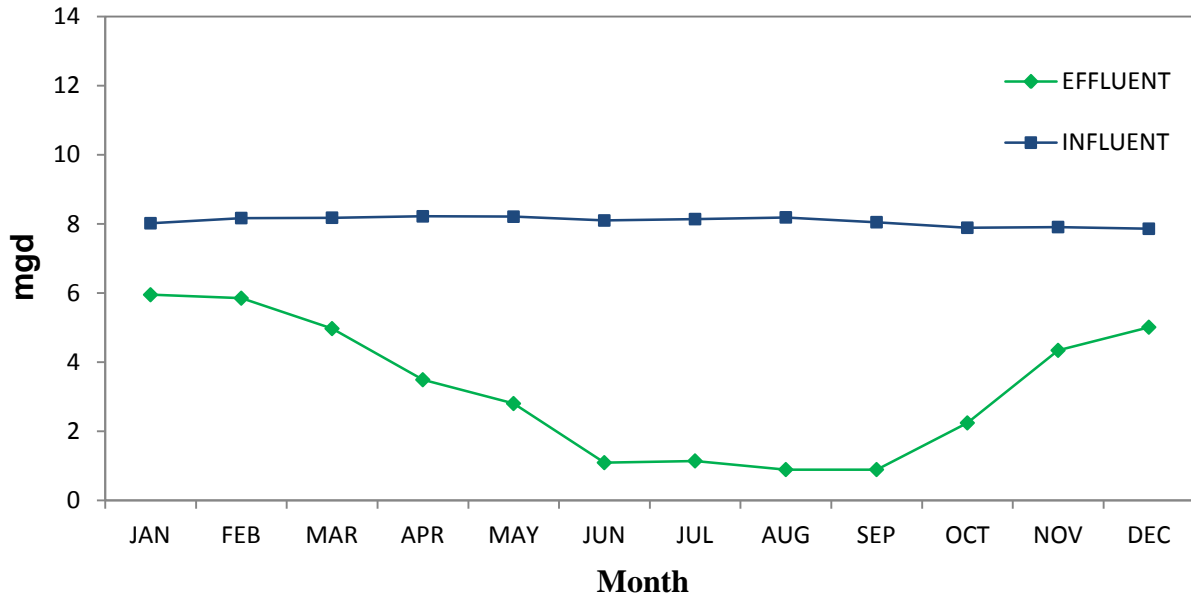

### Settleables Solids

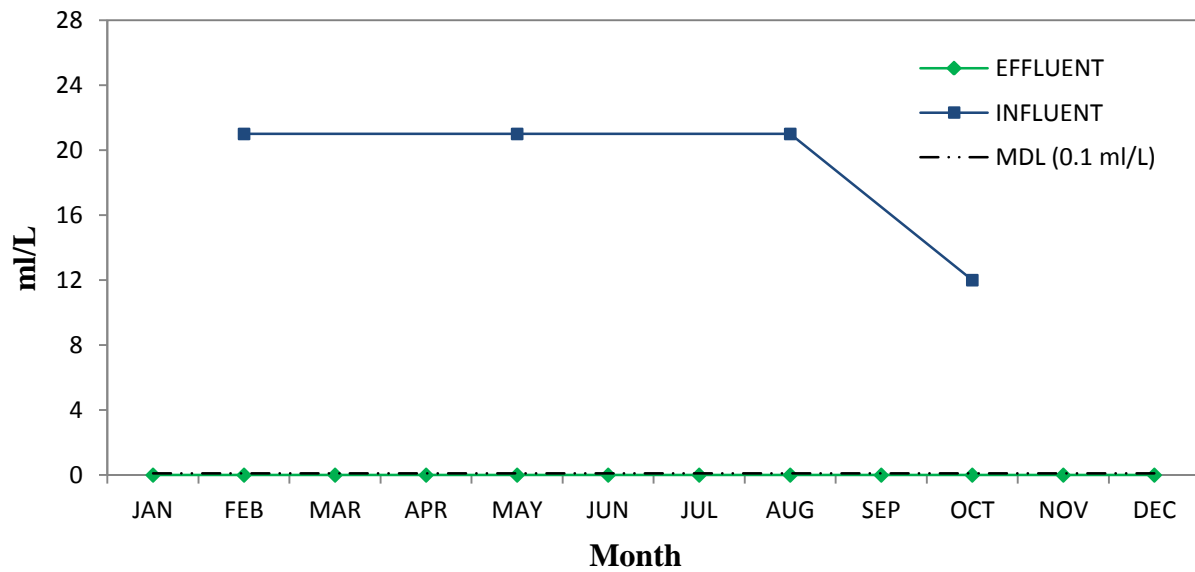

## 2013 South Bay Water Reclamation Plant Monthly Averages

### BOD

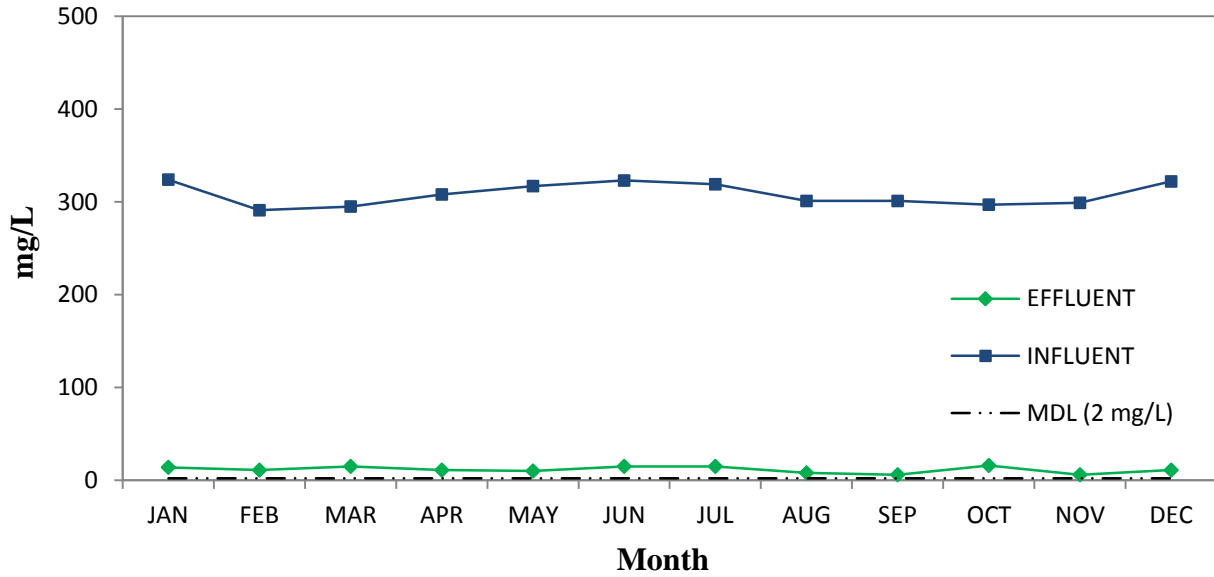

### BOD Removals

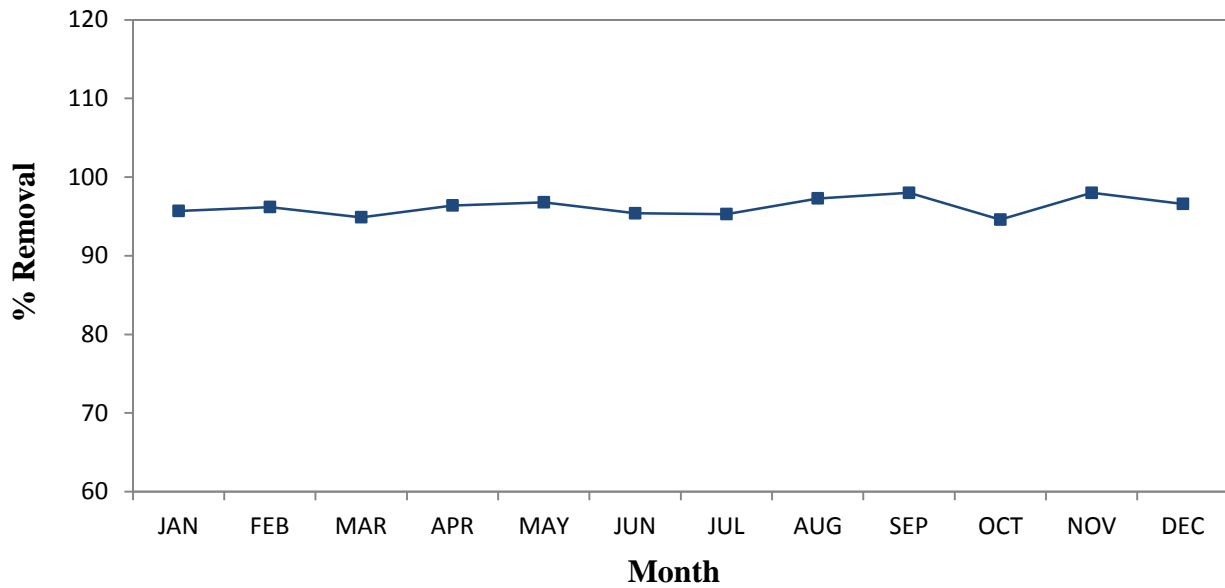



## 2013 South Bay Water Reclamation Plant Monthly Averages

### TSS

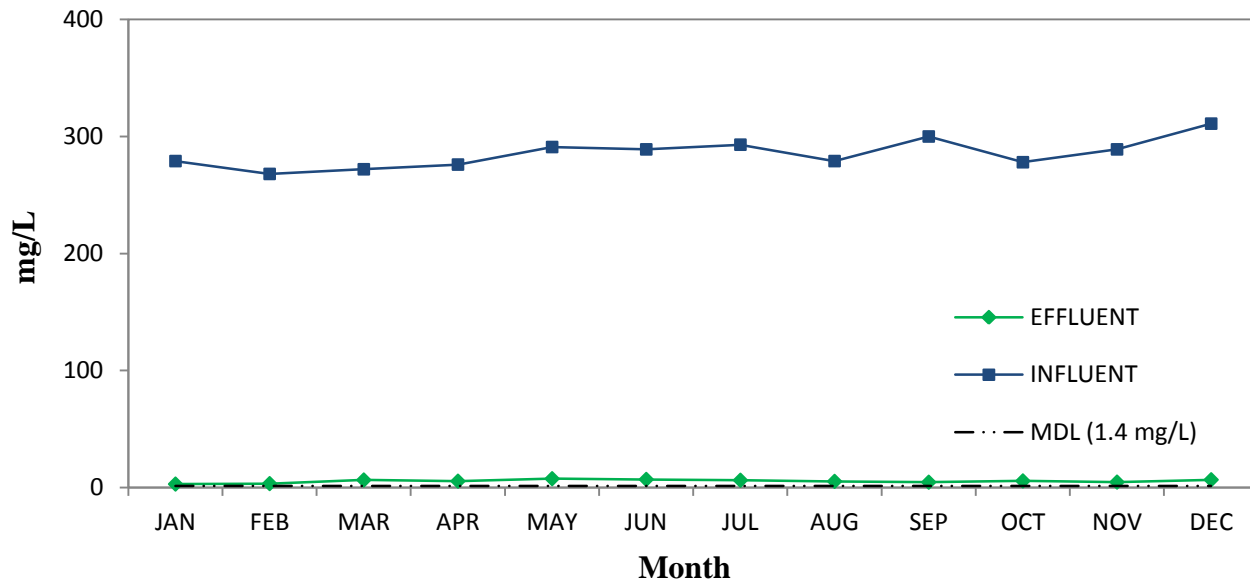

### TSS Removals

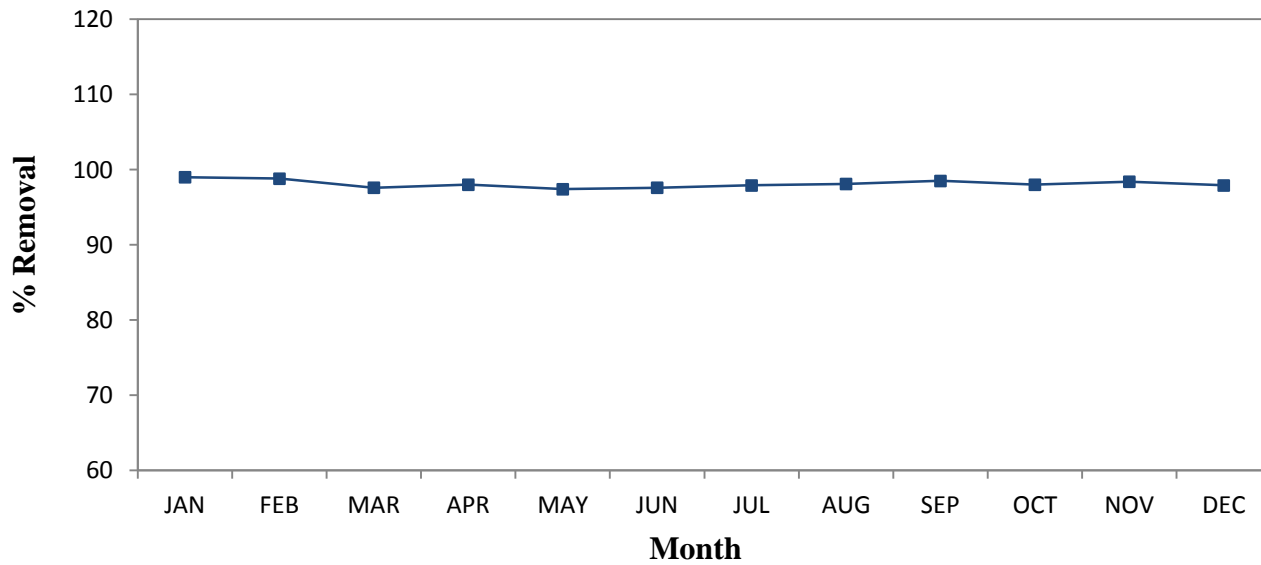

## 2013 South Bay Water Reclamation Plant Monthly Averages

### VSS

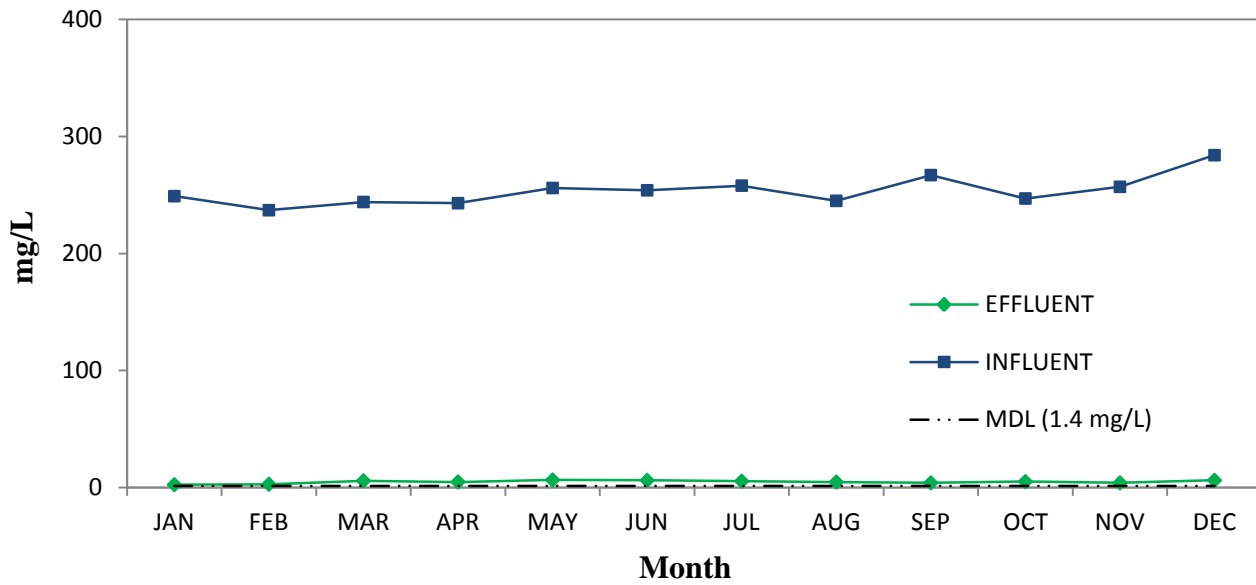

### Turbidity

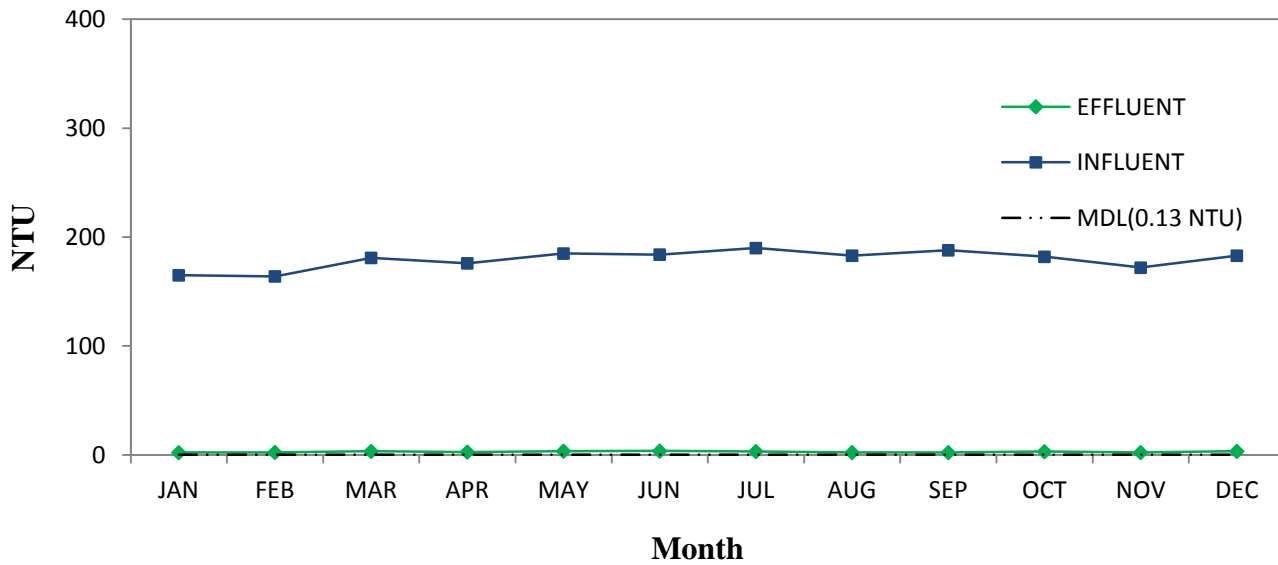

## 2013 South Bay Water Reclamation Plant Monthly Averages

### TDS

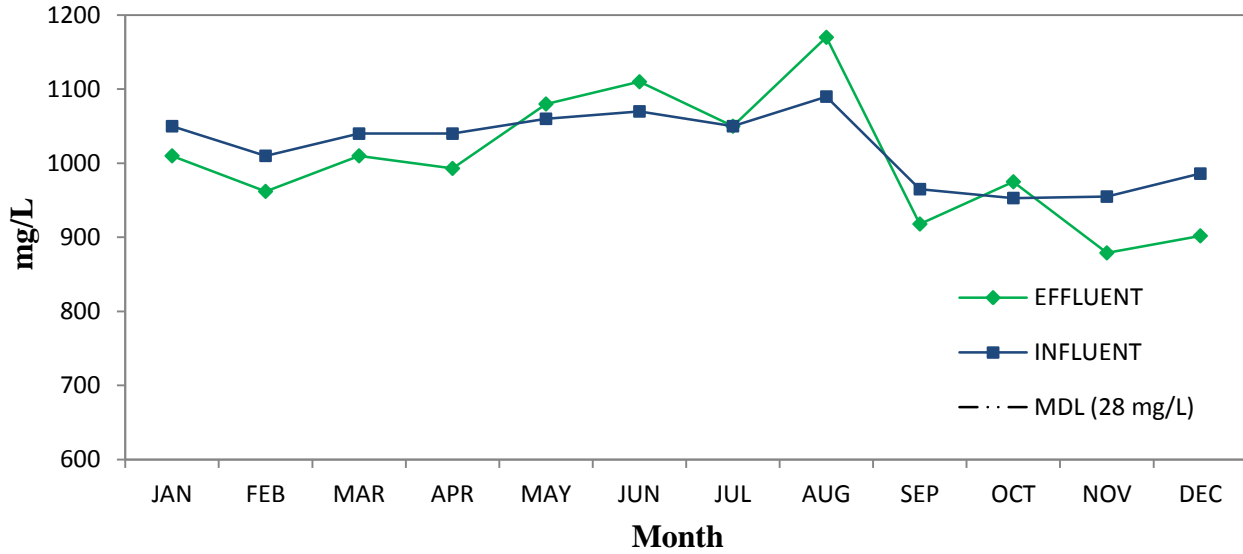

### Oil & Grease

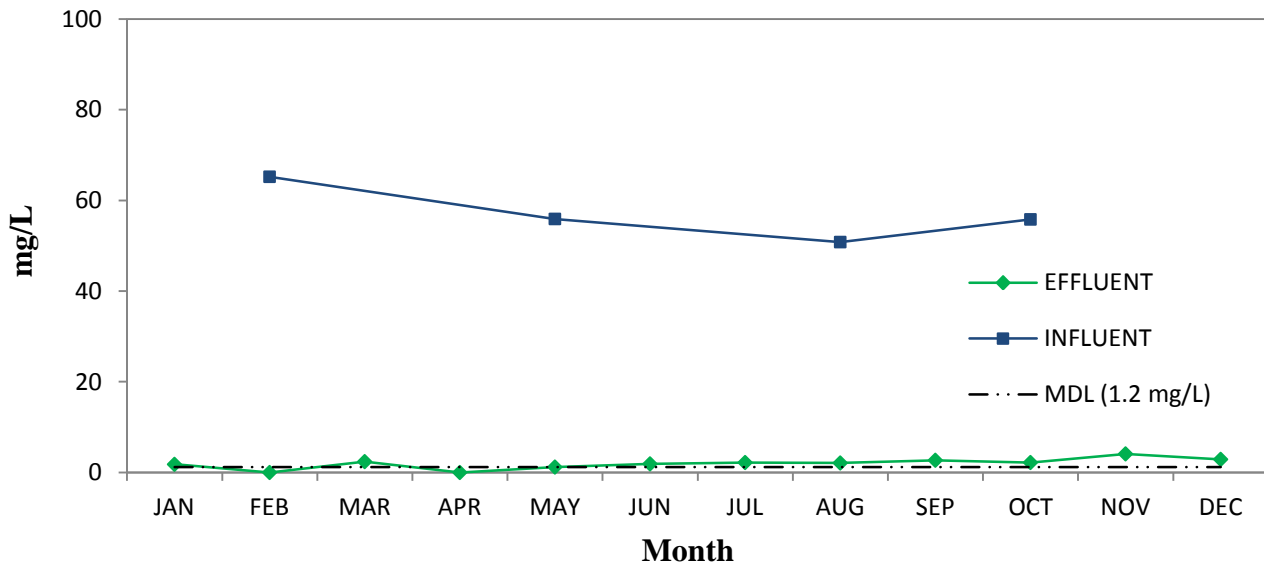

# 2013 South Bay Water Reclamation Plant Monthly Averages

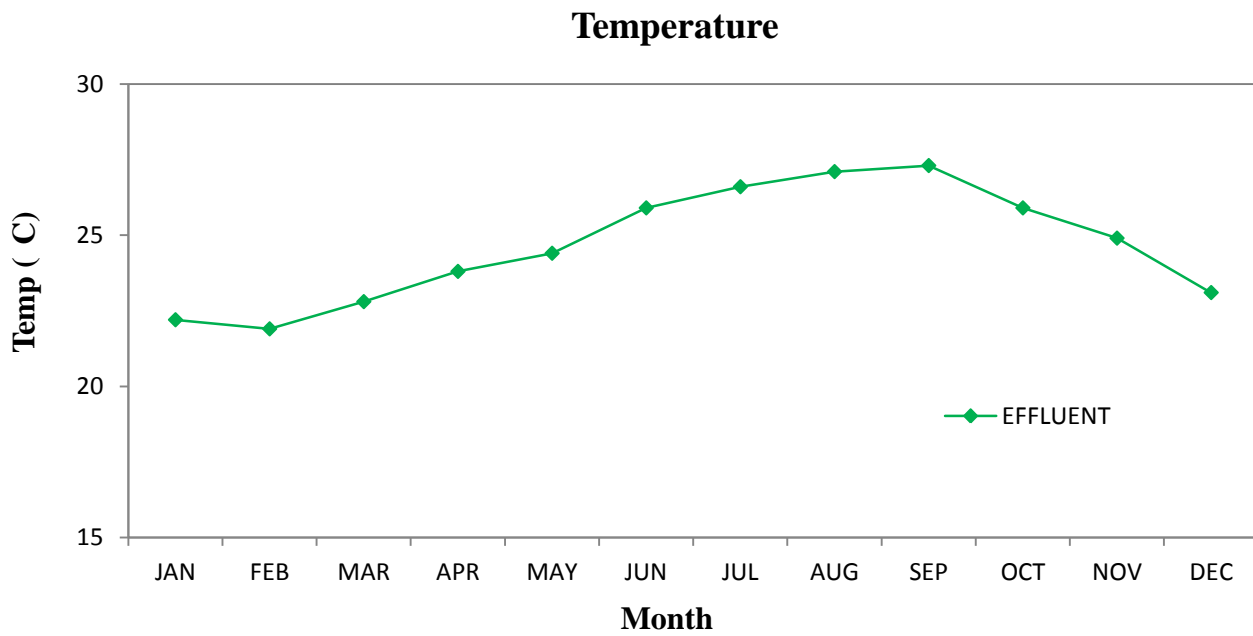
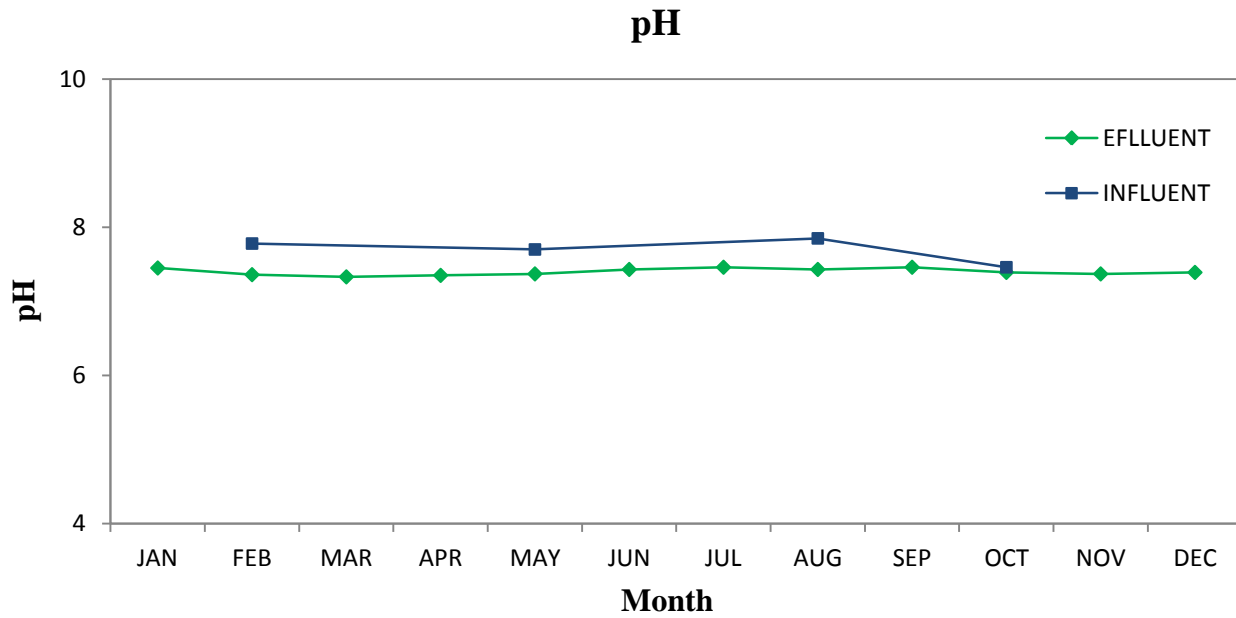

# 2013 South Bay Water Reclamation Plant Monthly Averages

## Dissolved Oxygen

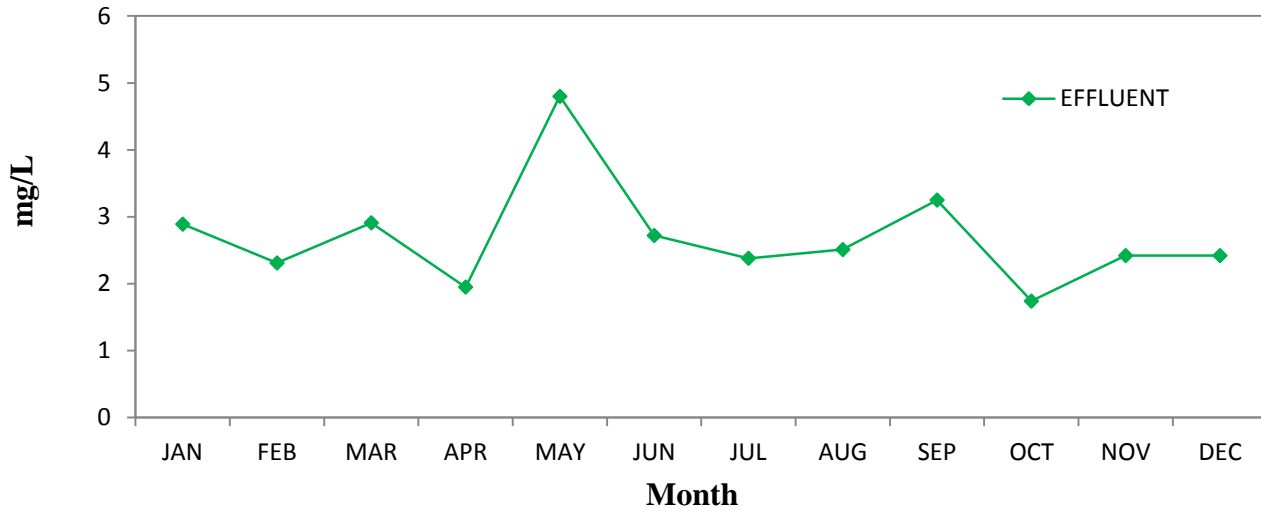

## Ammonia-N

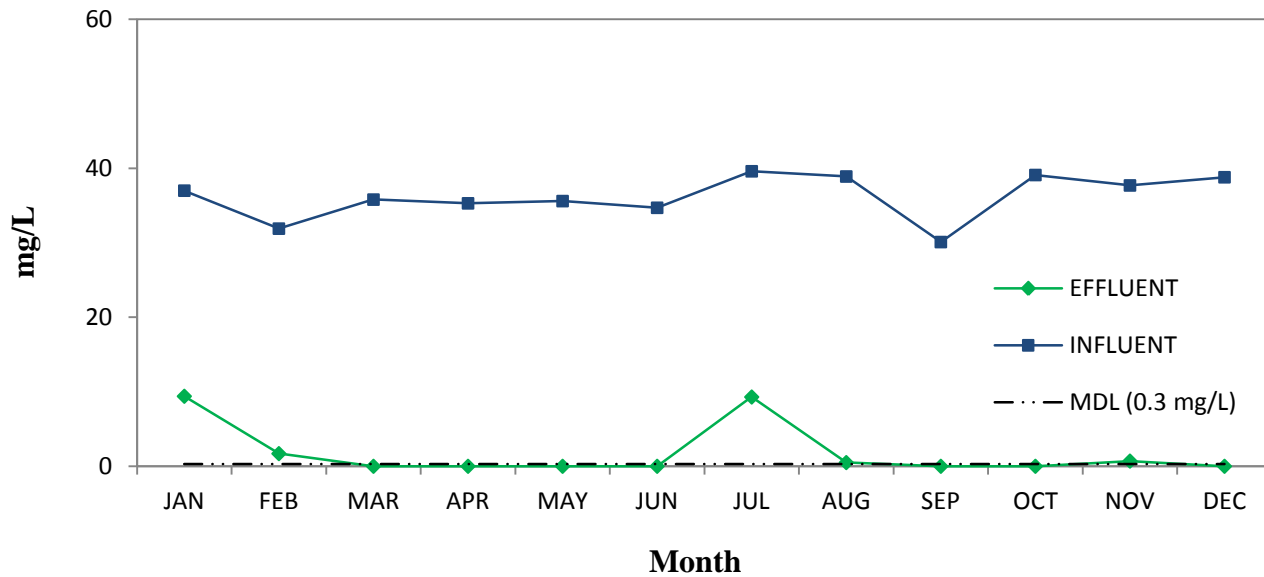

2013 South Bay Water Reclamation Plant  
Monthly Averages

Residual Chlorine

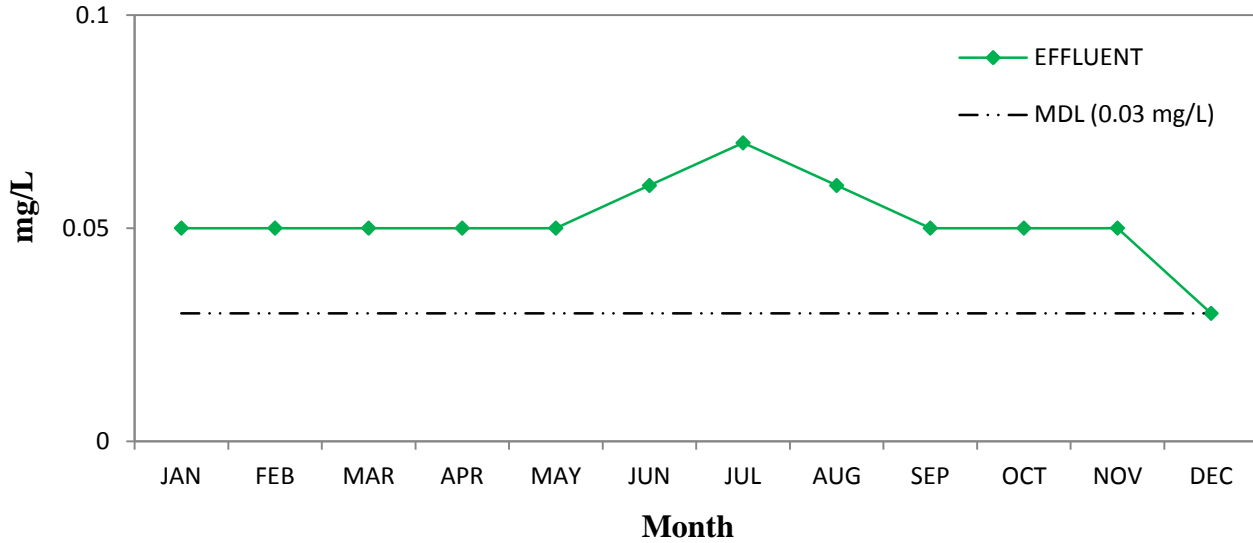

Total Cyanides

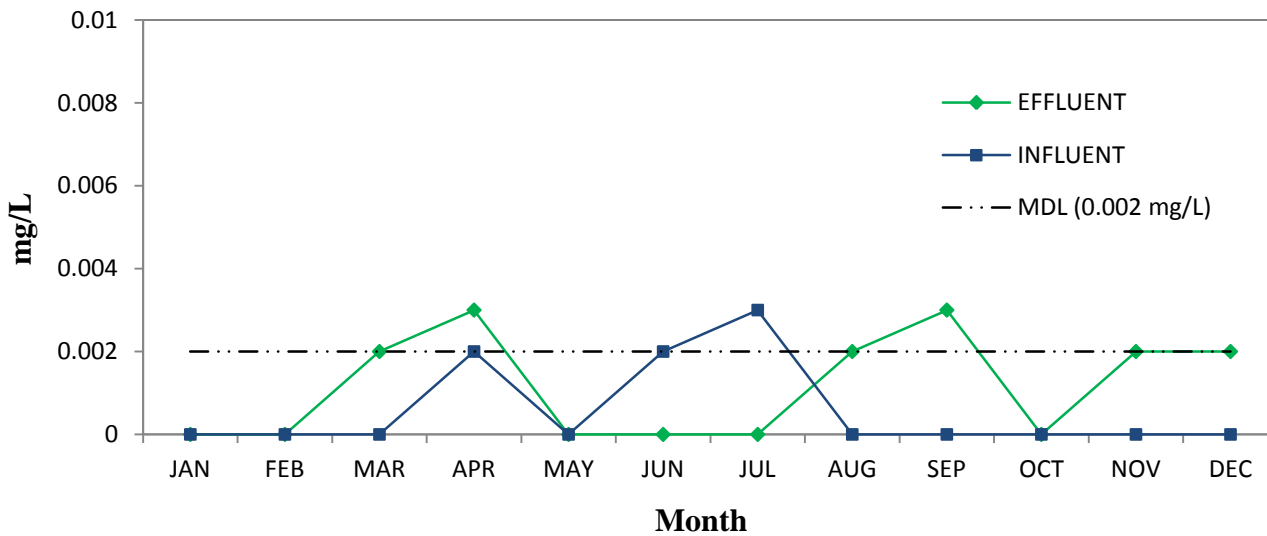

2013 South Bay Water Reclamation Plant  
Monthly Averages

Alpha Radiation

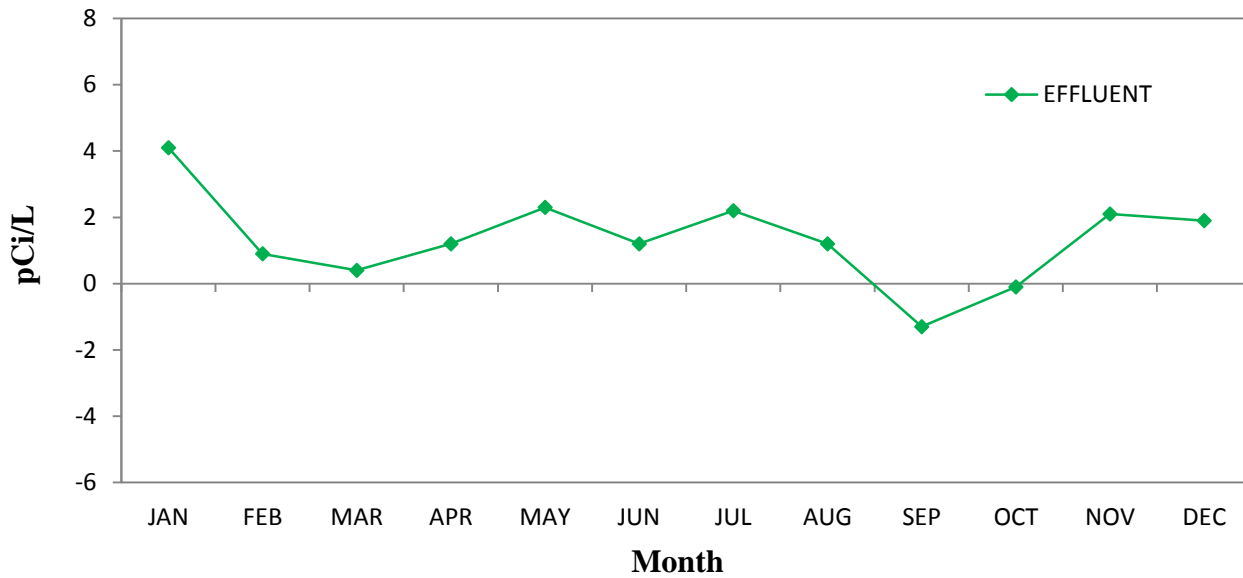

Beta Radiation

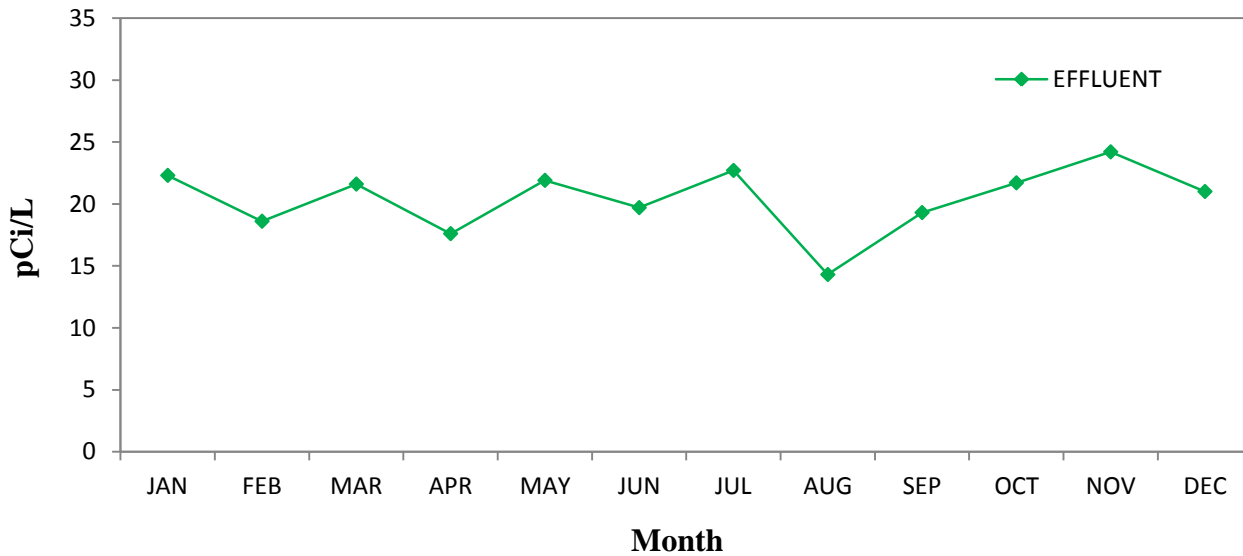

2013 South Bay Water Reclamation Plant  
Monthly Averages

Total Chlorinated Hydrocarbons

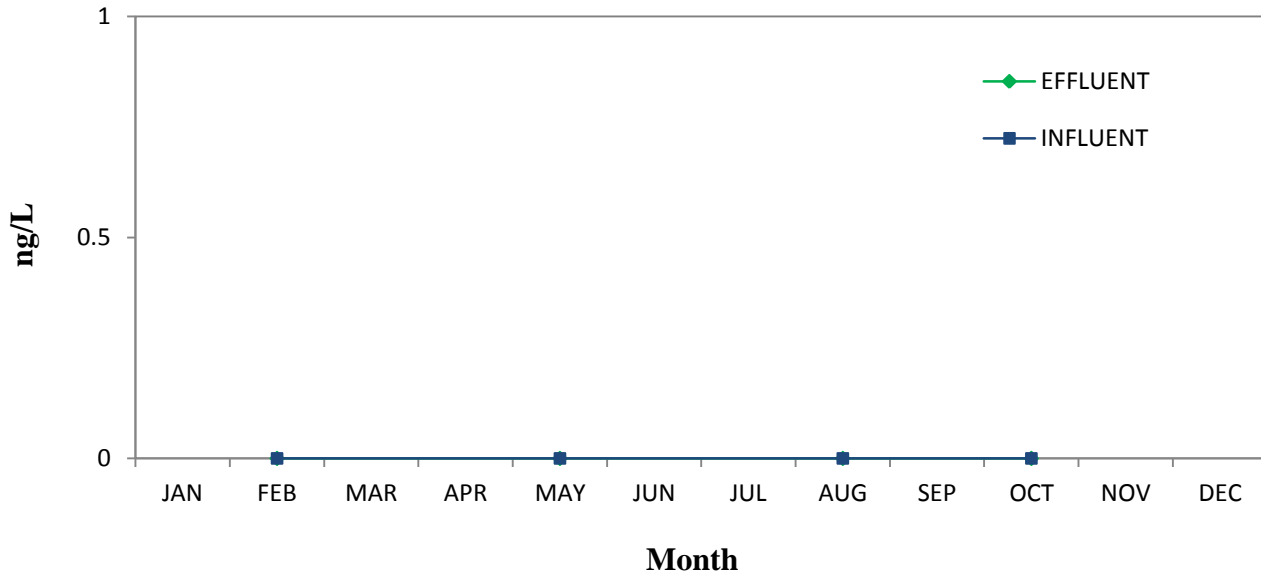

Antimony

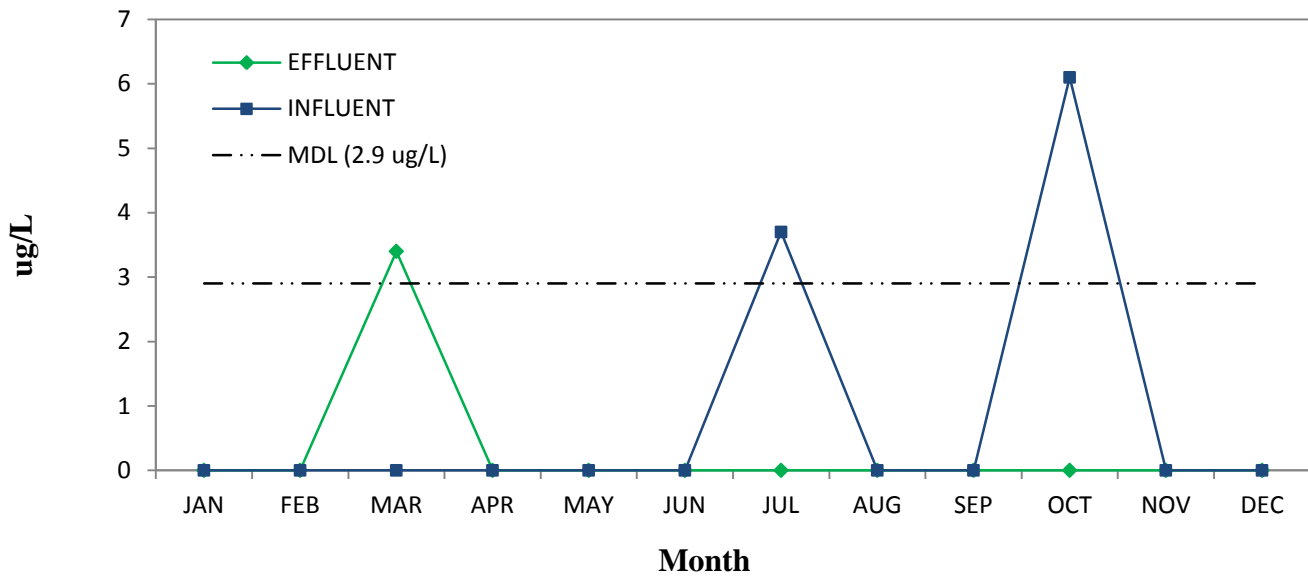



## 2013 South Bay Water Reclamation Plant Monthly Averages

### Arsenic

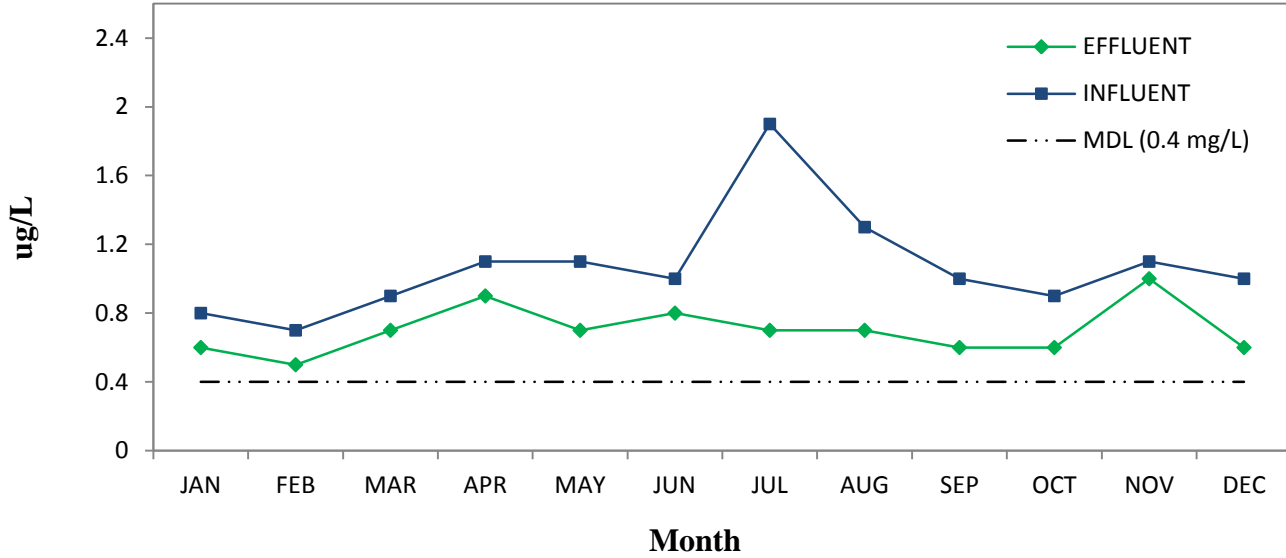

### Beryllium

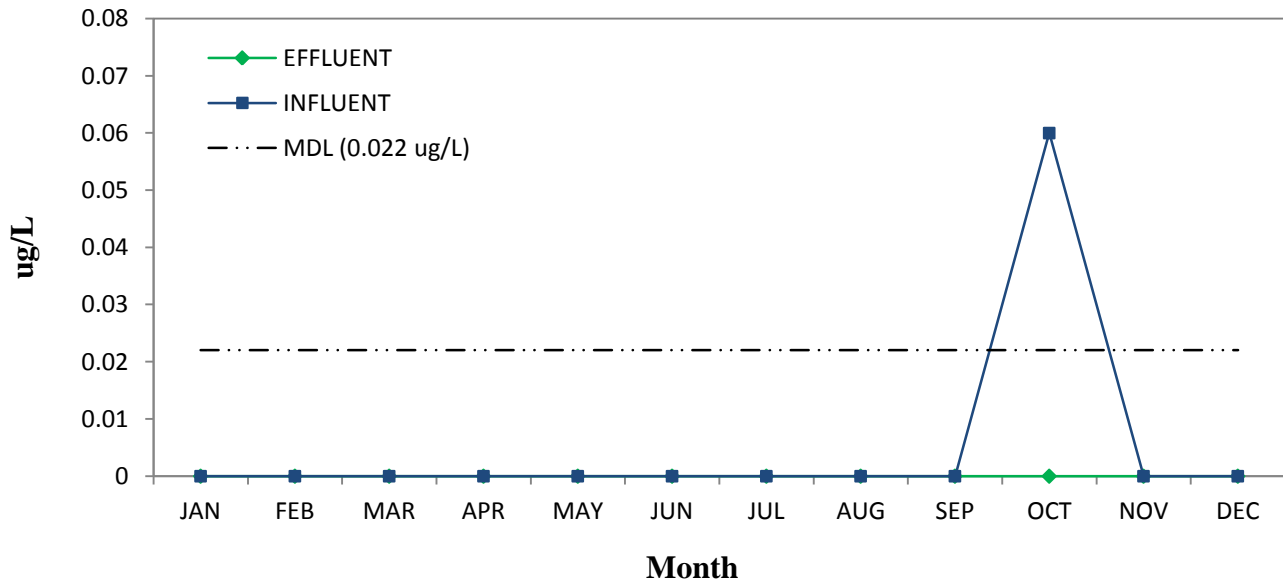

**2013 South Bay Water Reclamation Plant  
Monthly Averages**

**Cadmium**

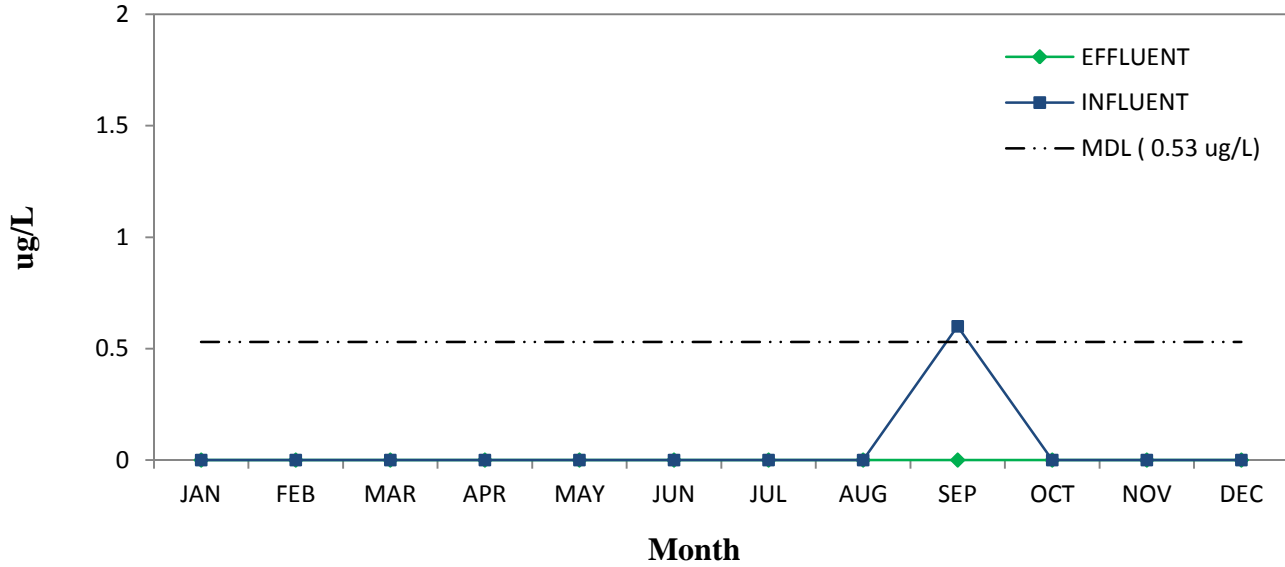

**Chromium**

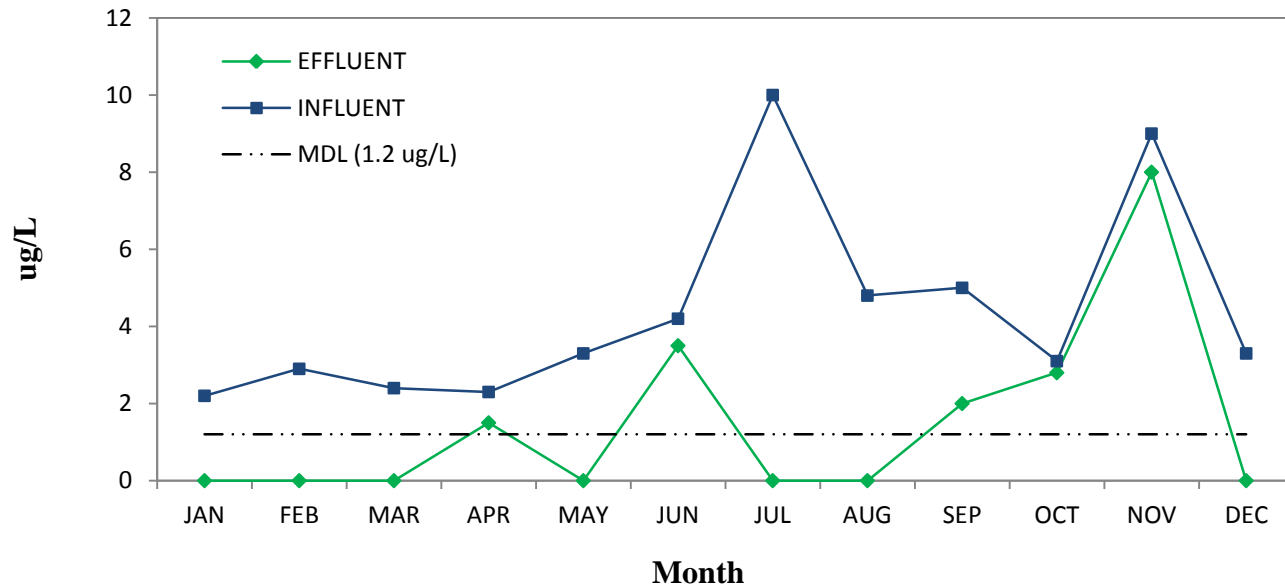

## 2013 South Bay Water Reclamation Plant Monthly Averages

### Copper

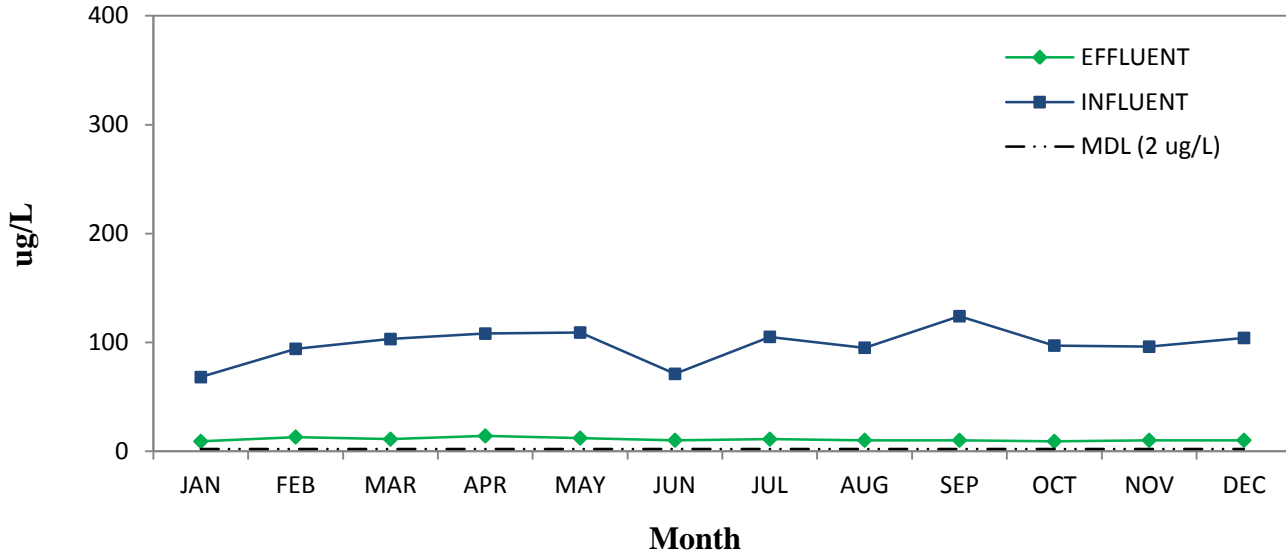

### Iron

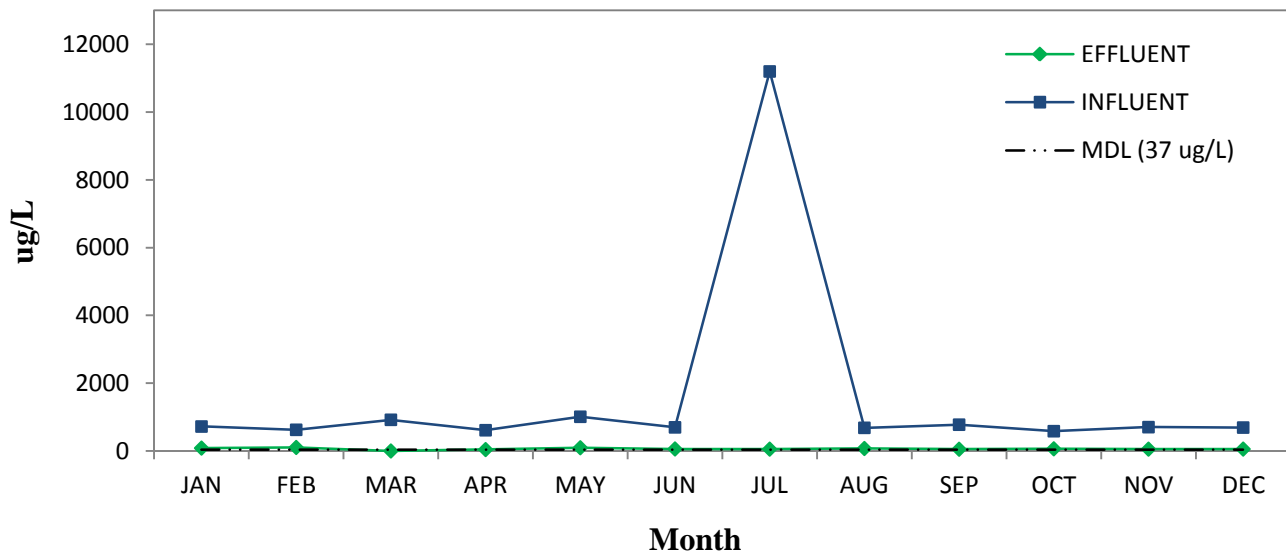

**2013 South Bay Water Reclamation Plant  
Monthly Averages**

**Lead**

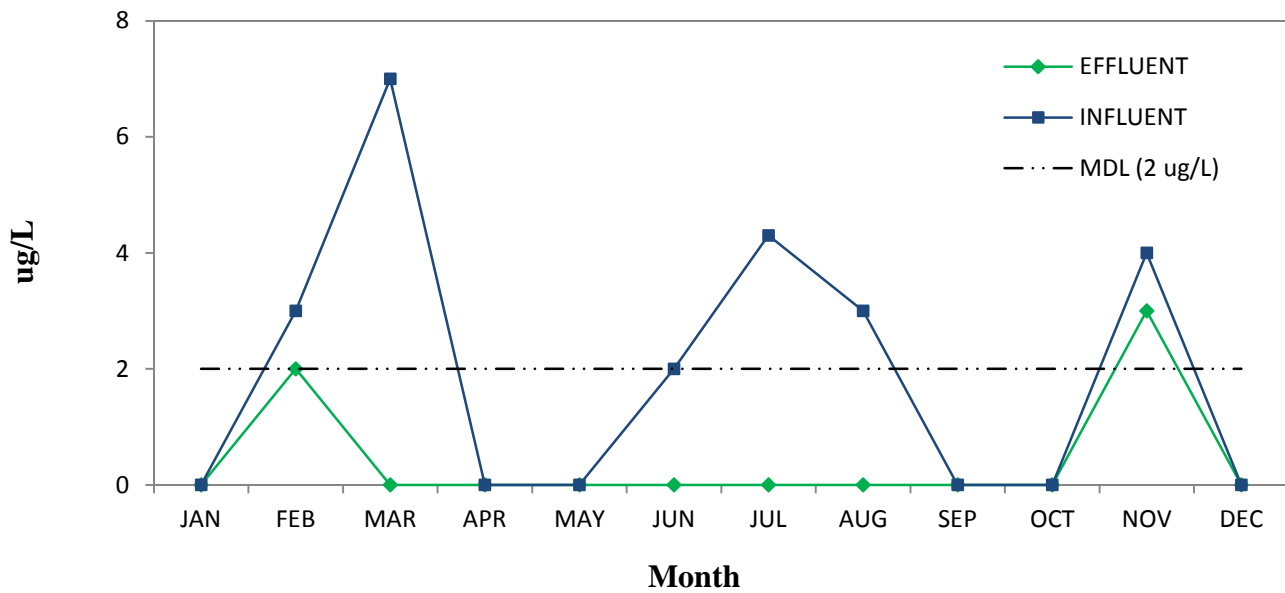

**Mercury**

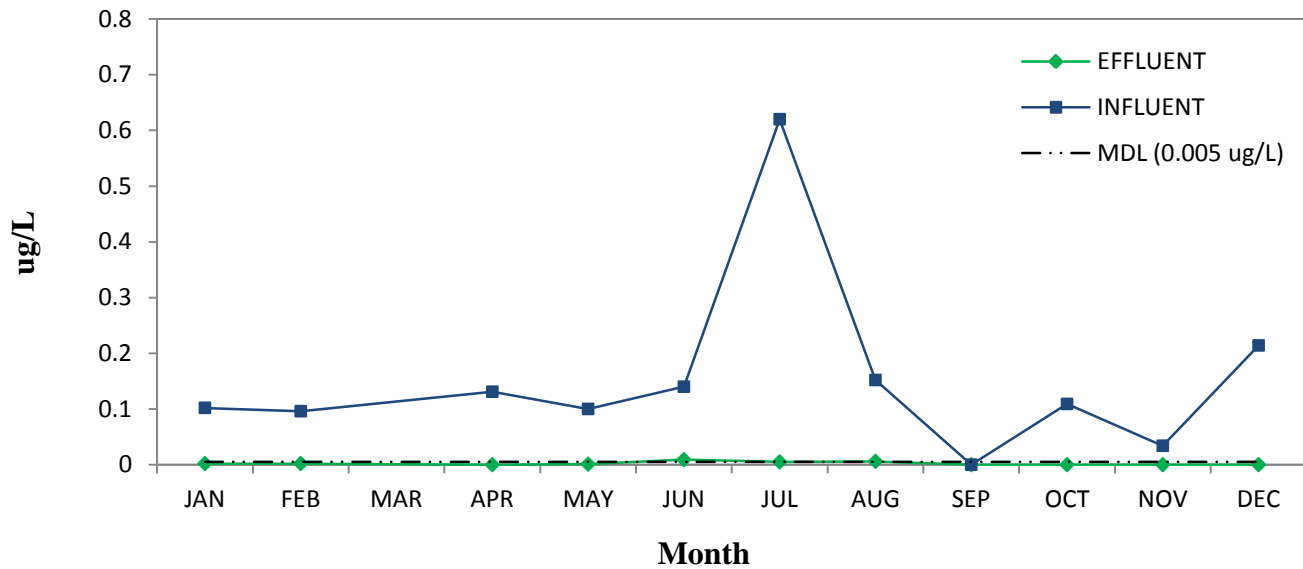

## 2013 South Bay Water Reclamation Plant Monthly Averages

### Nickel

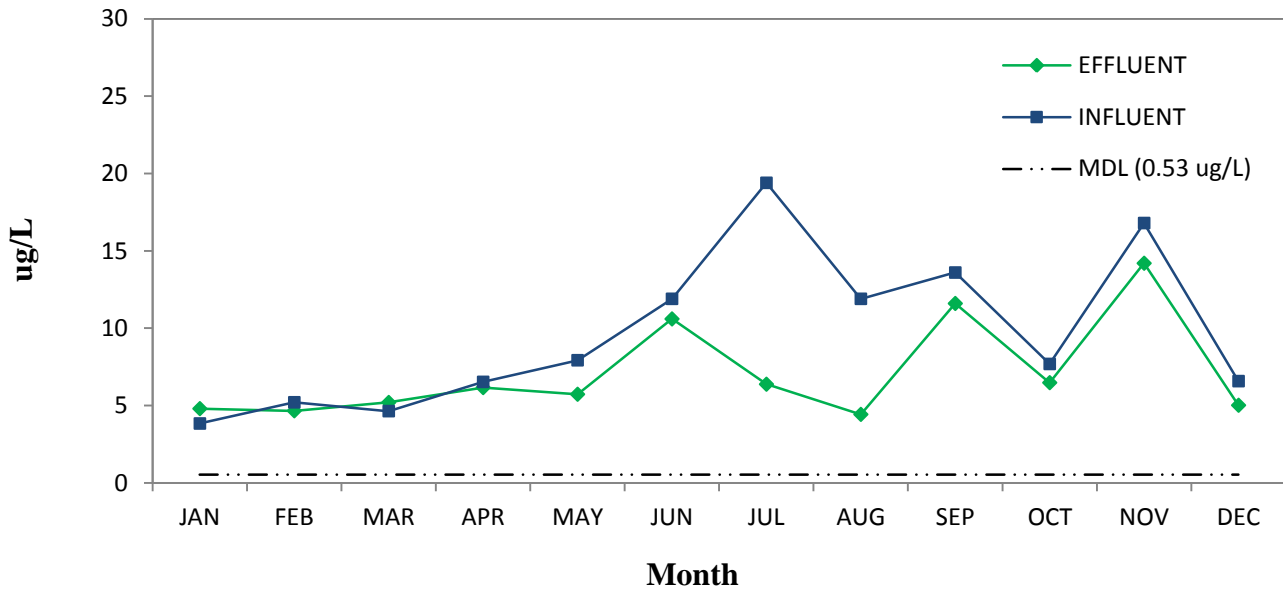

### Selenium

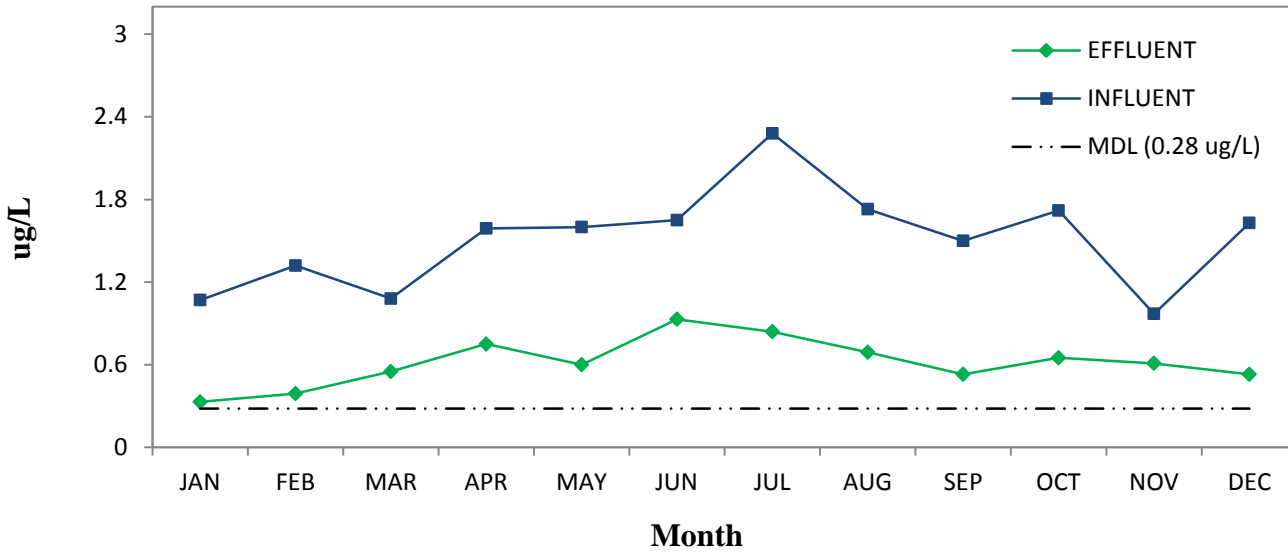

# 2013 South Bay Water Reclamation Plant Monthly Averages

## Silver

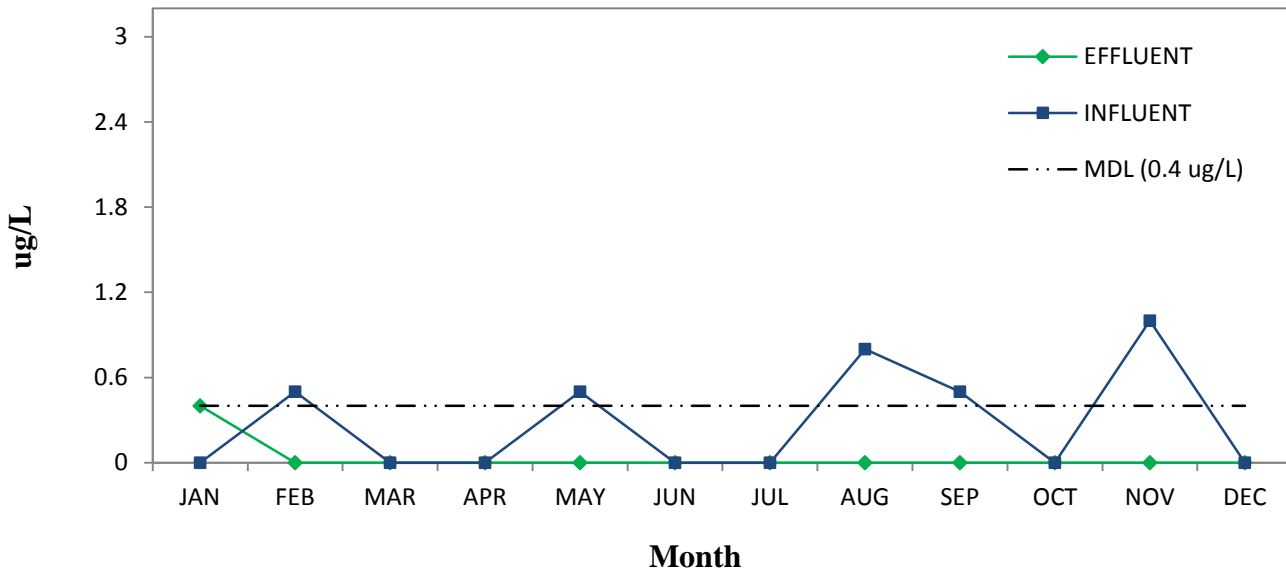

## Thallium

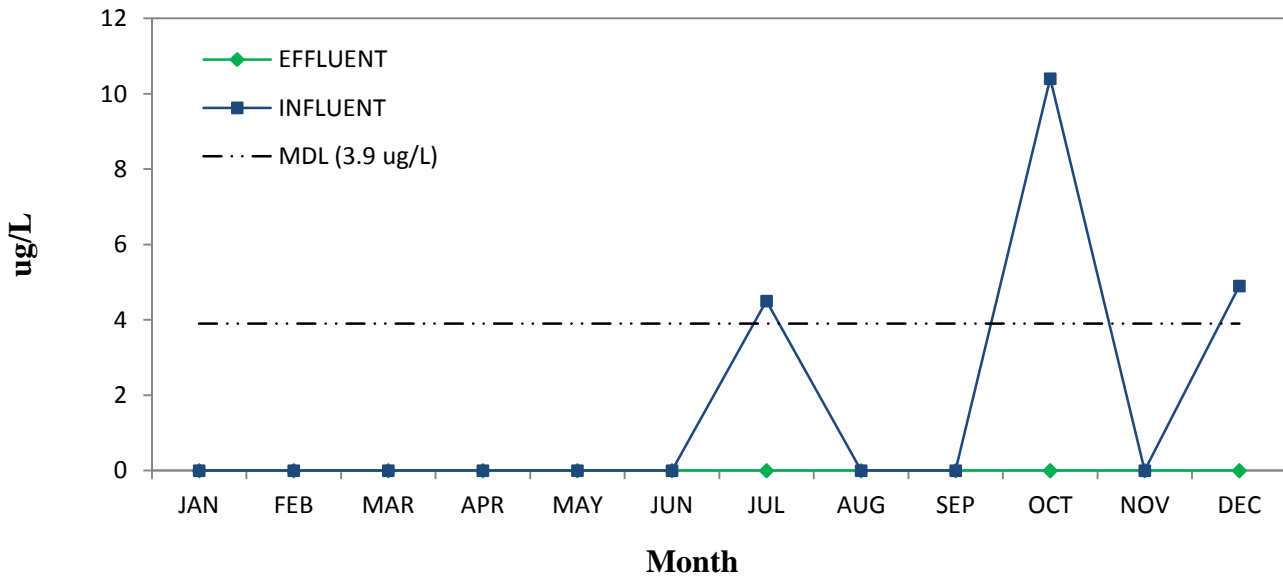

## 2013 South Bay Water Reclamation Plant Monthly Averages

### Zinc

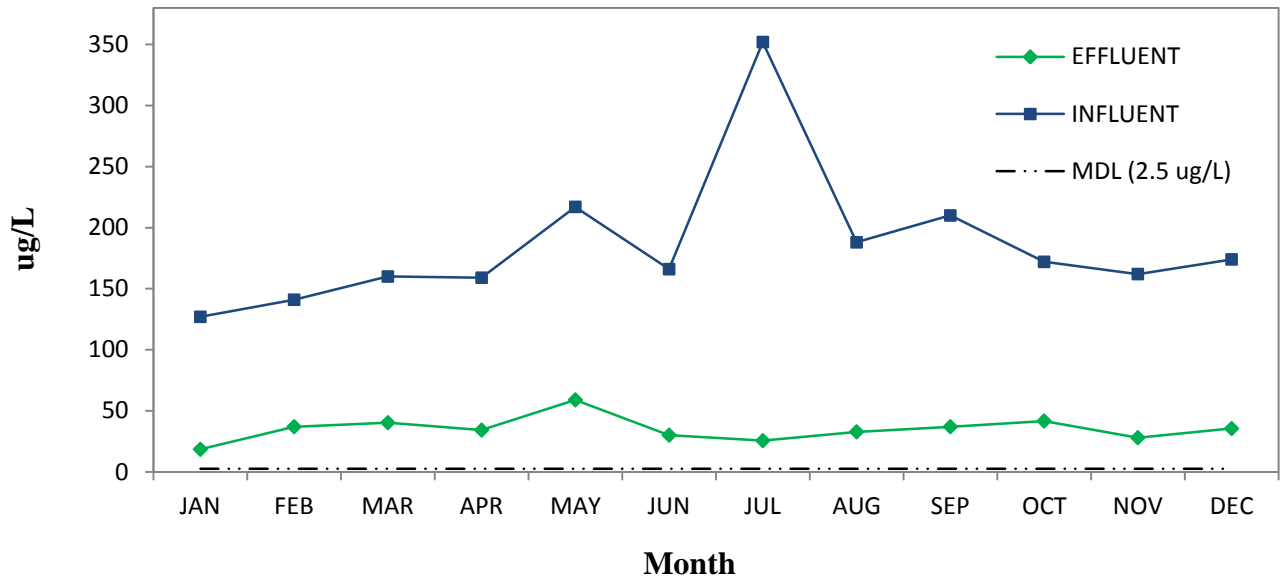

### Aluminum

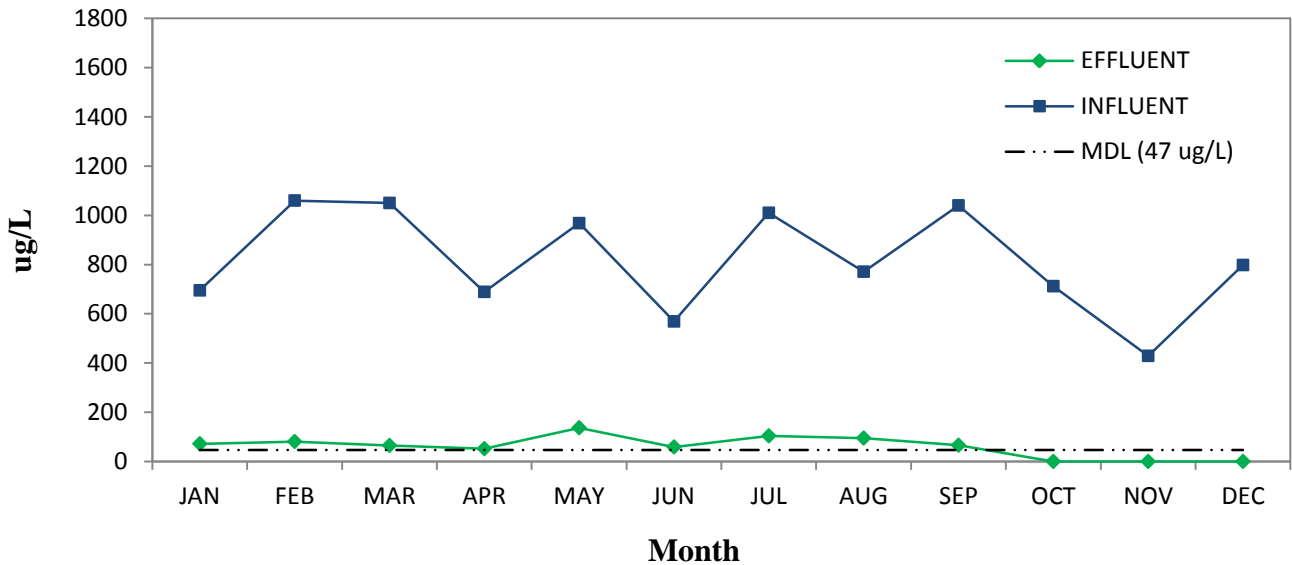

## 2013 South Bay Water Reclamation Plant Monthly Averages

### Barium

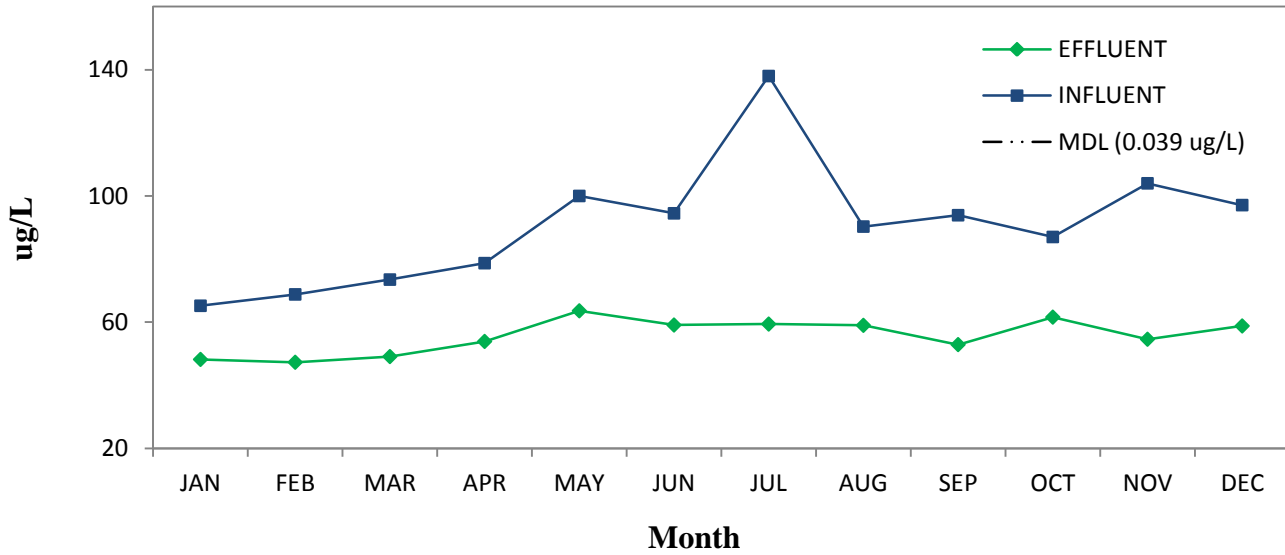

### Manganese

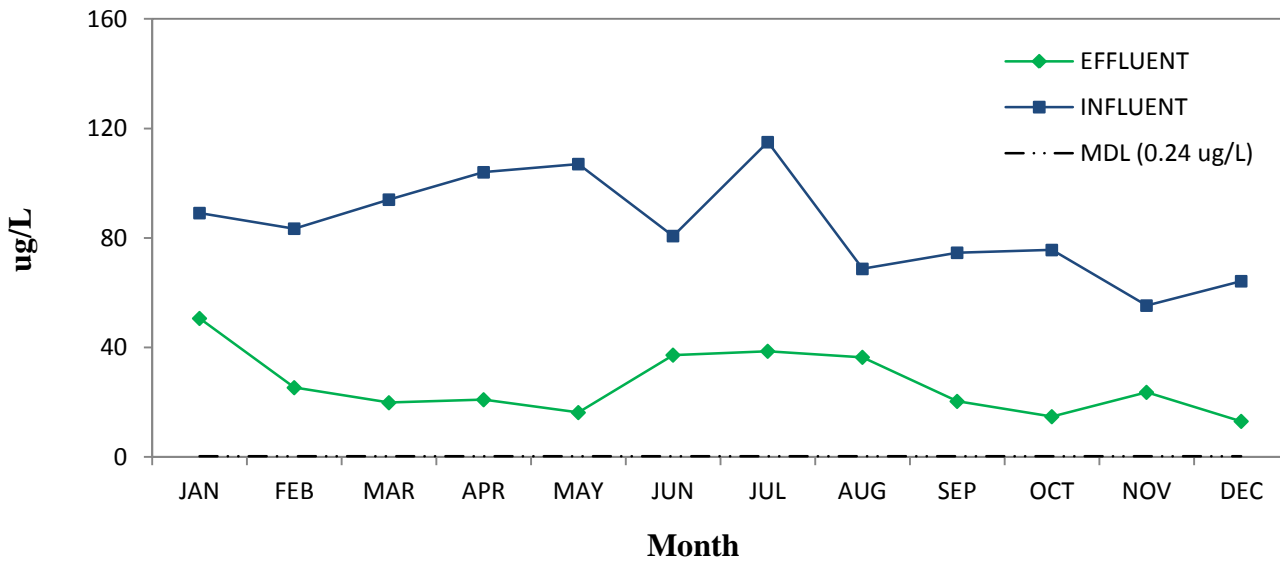



**2013 South Bay Water Reclamation Plant  
Monthly Averages**

**Vanadium**

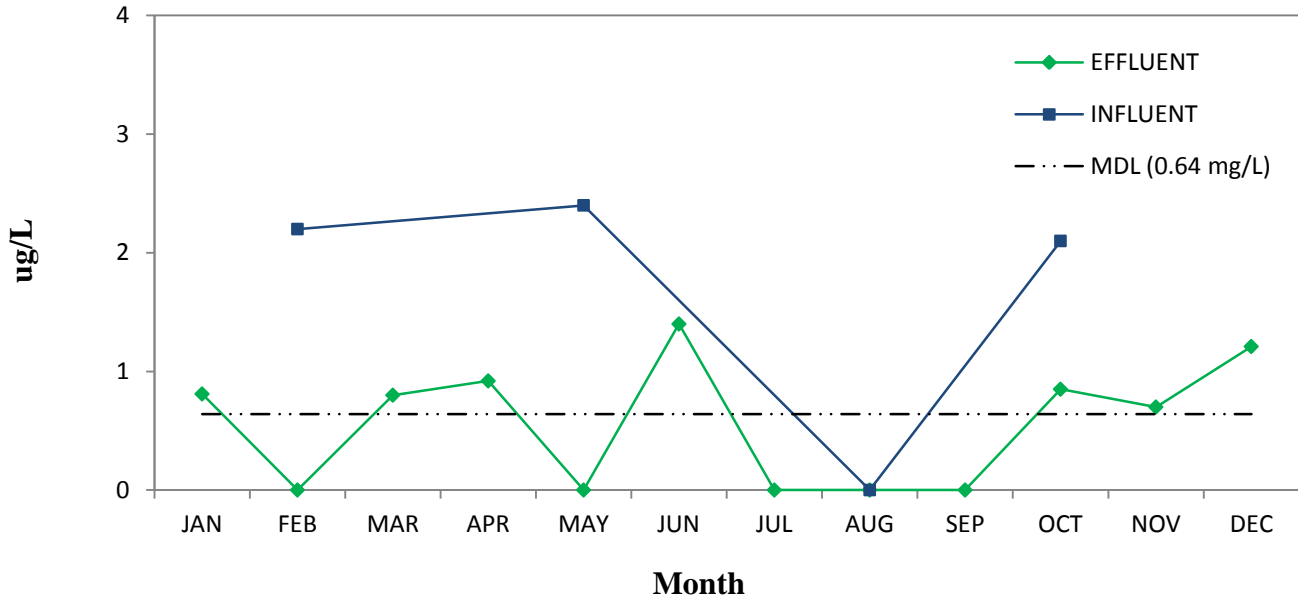

**Boron**

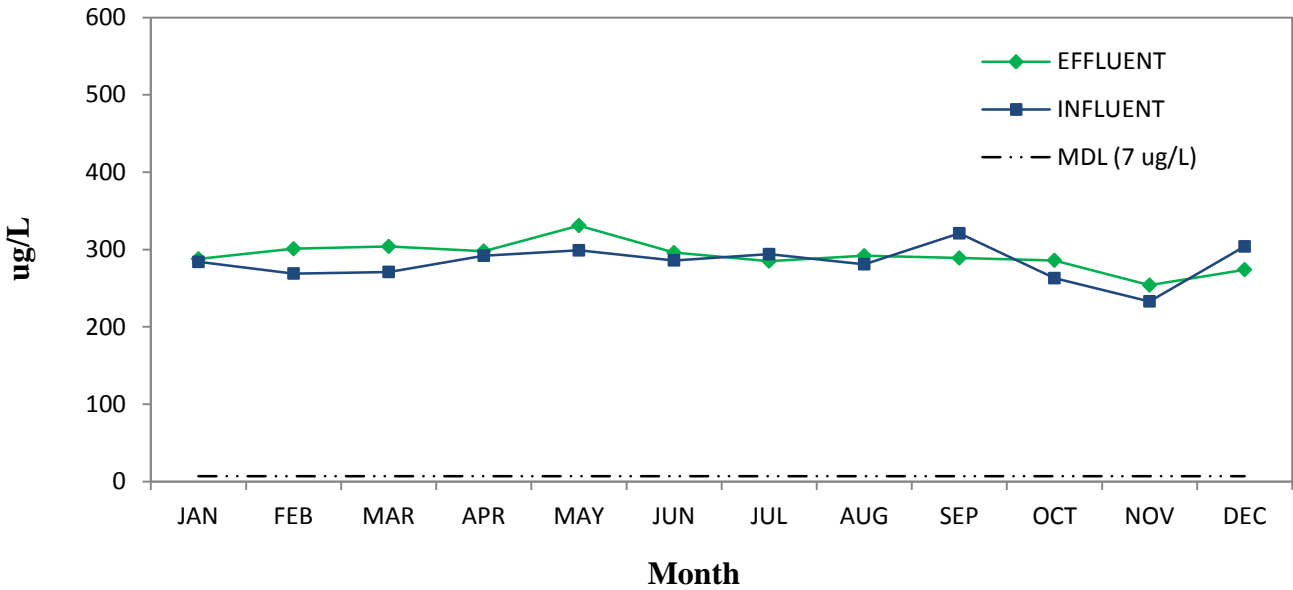

# 2013 South Bay Water Reclamation Plant Monthly Averages

## Cobalt

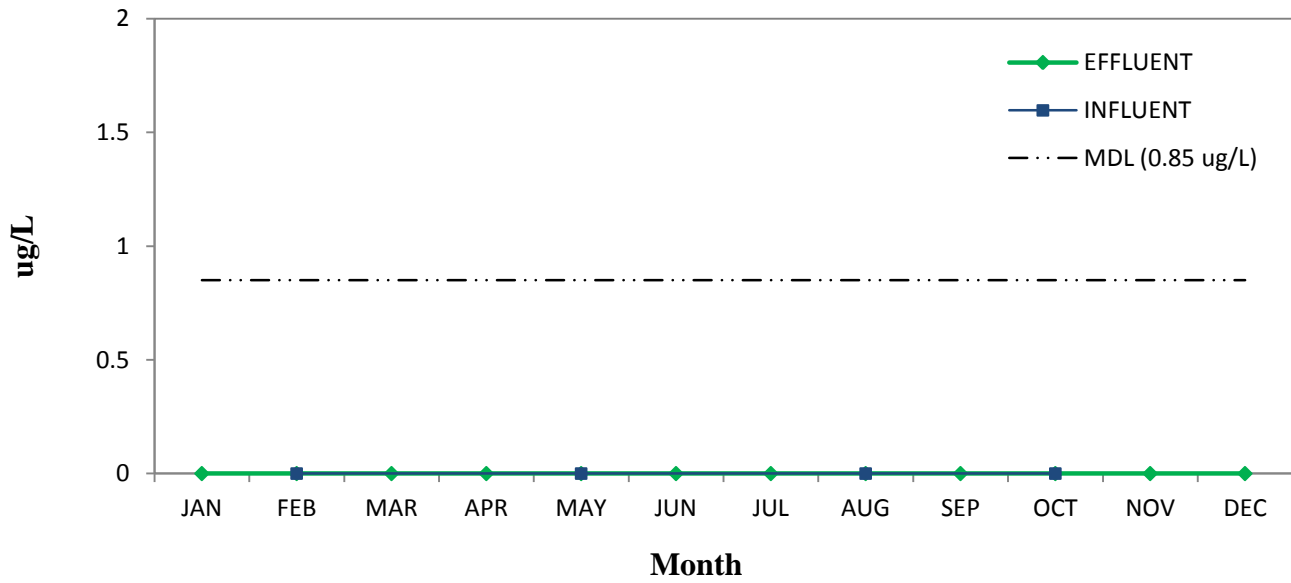

## Molybdenum

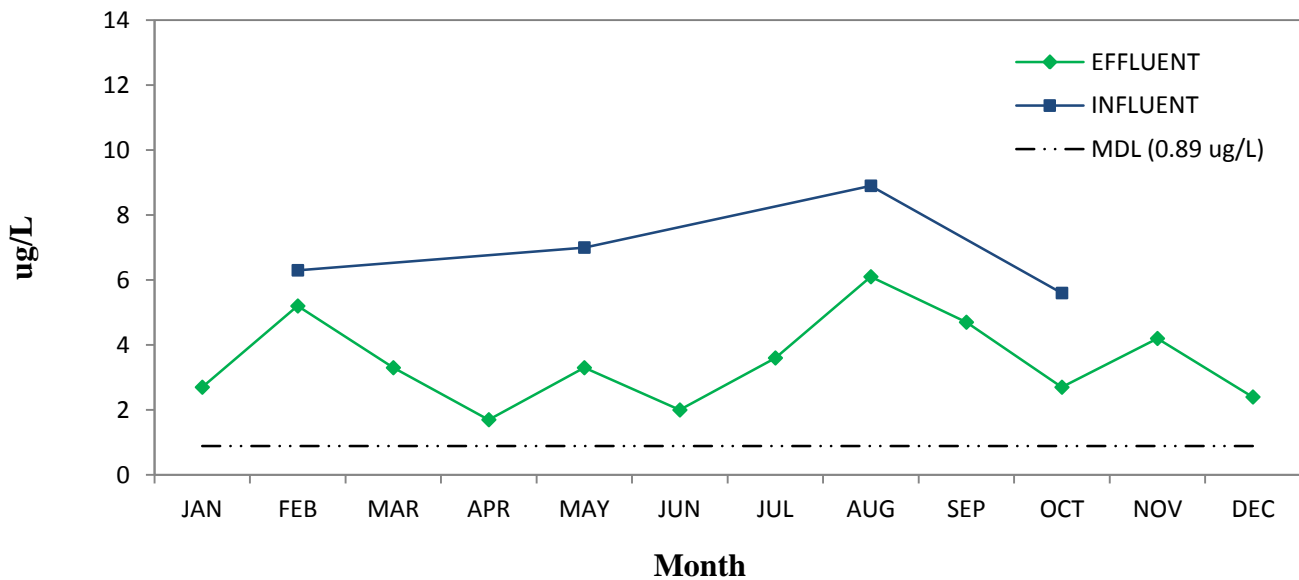

## 2013 South Bay Water Reclamation Plant Monthly Averages

### Potassium

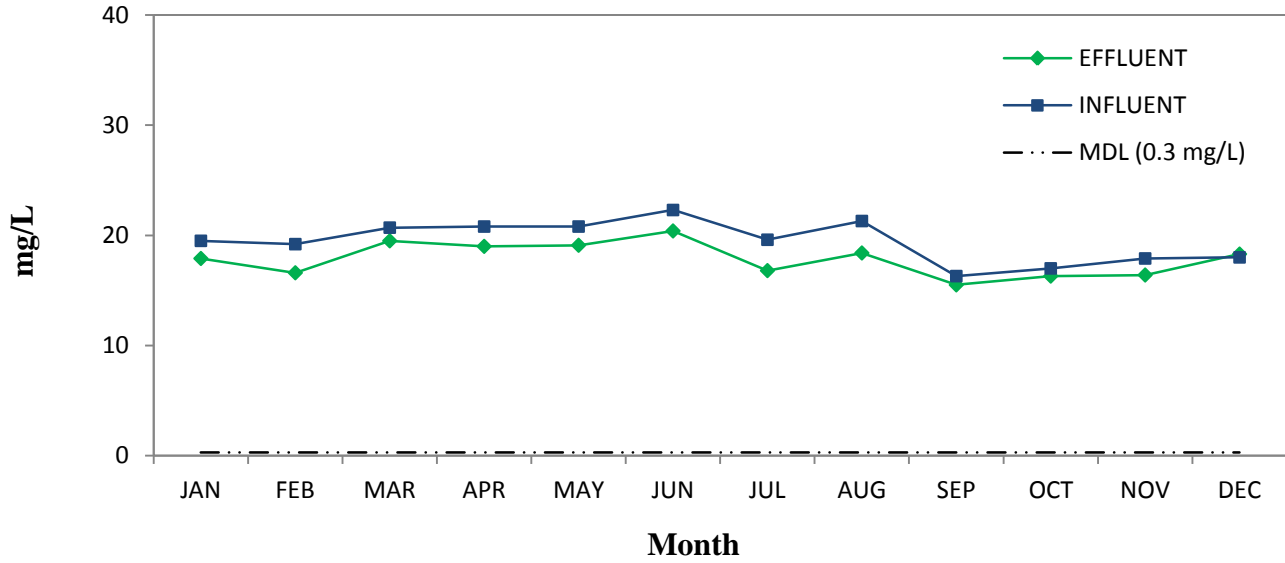

### Calcium

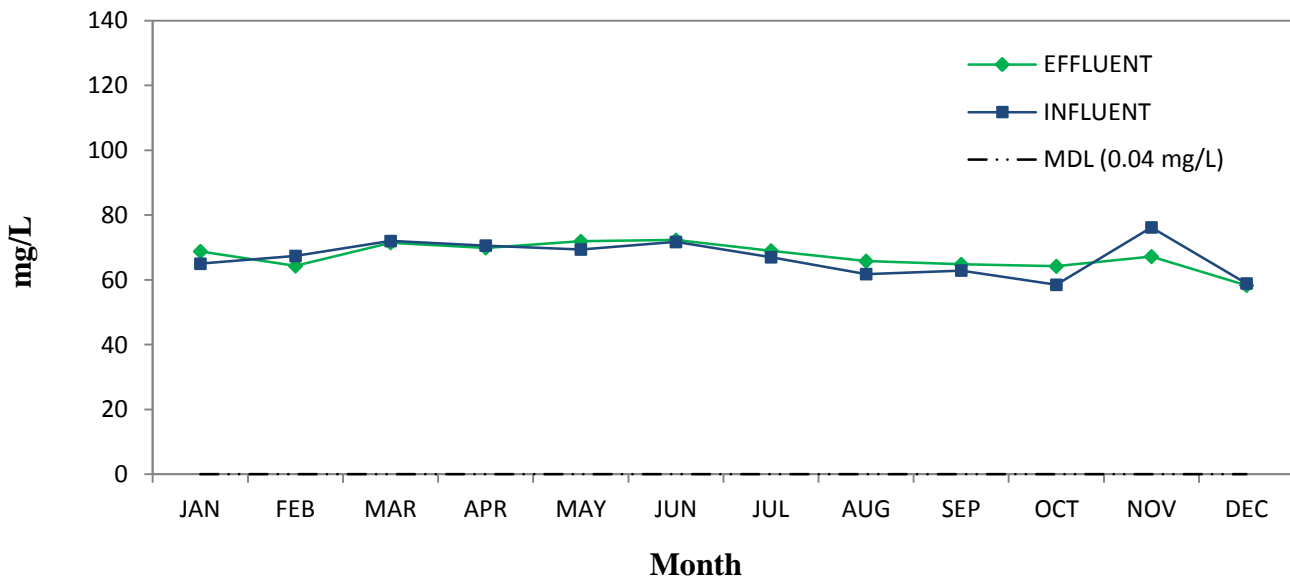

**2013 South Bay Water Reclamation Plant  
Monthly Averages**

**Magnesium**

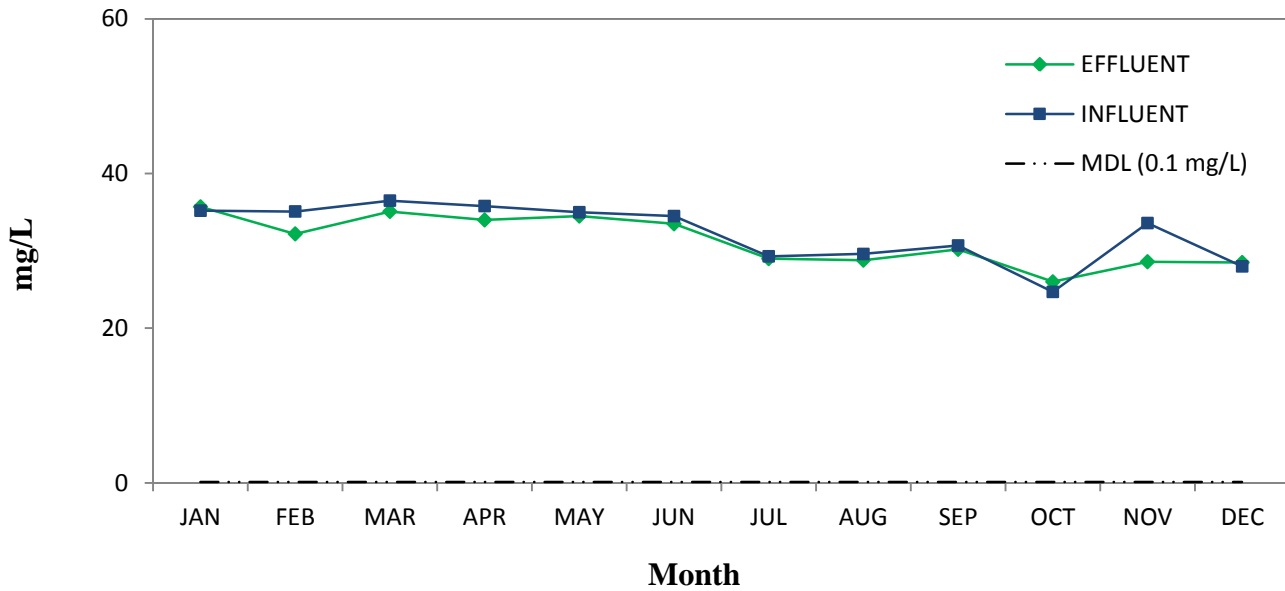

**Lithium**

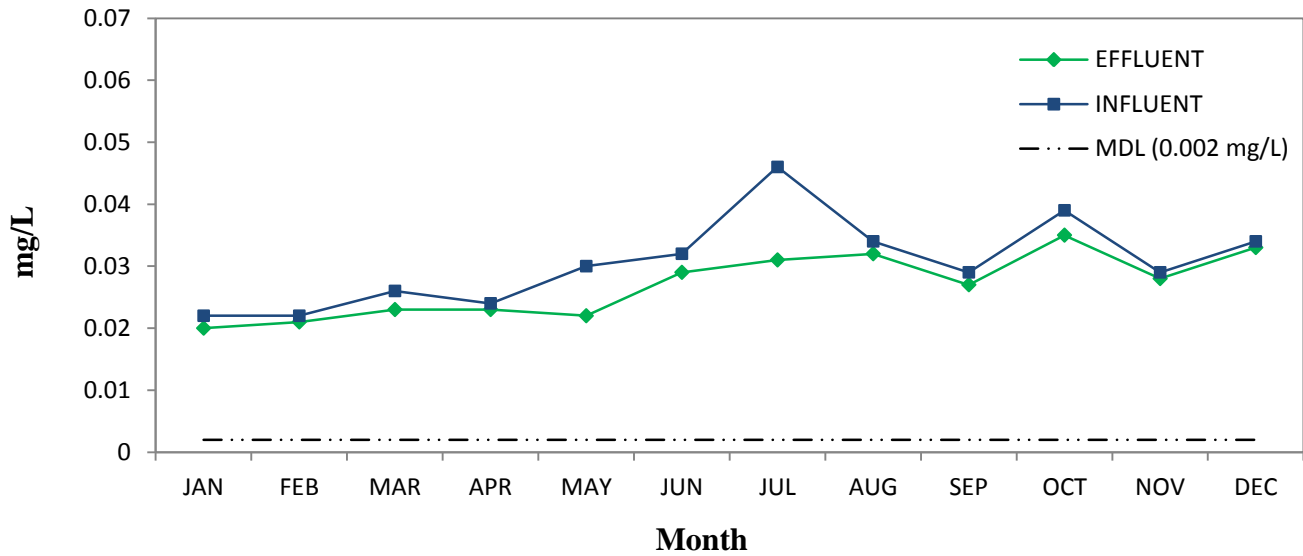

**2013 South Bay Water Reclamation Plant  
Monthly Averages**

**Sodium**

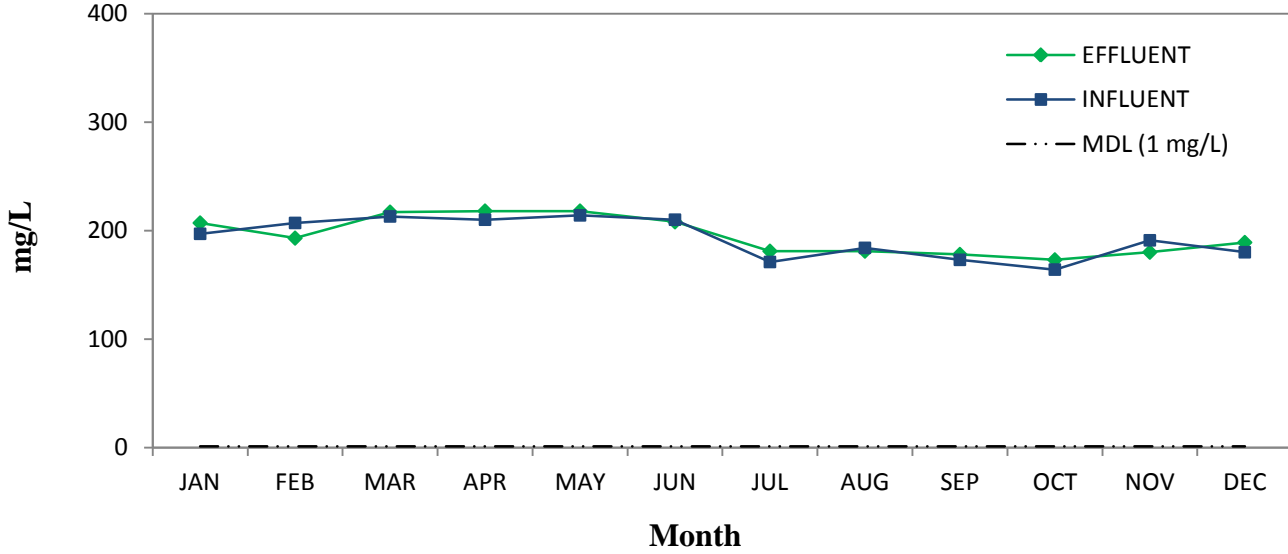

**Bromide**

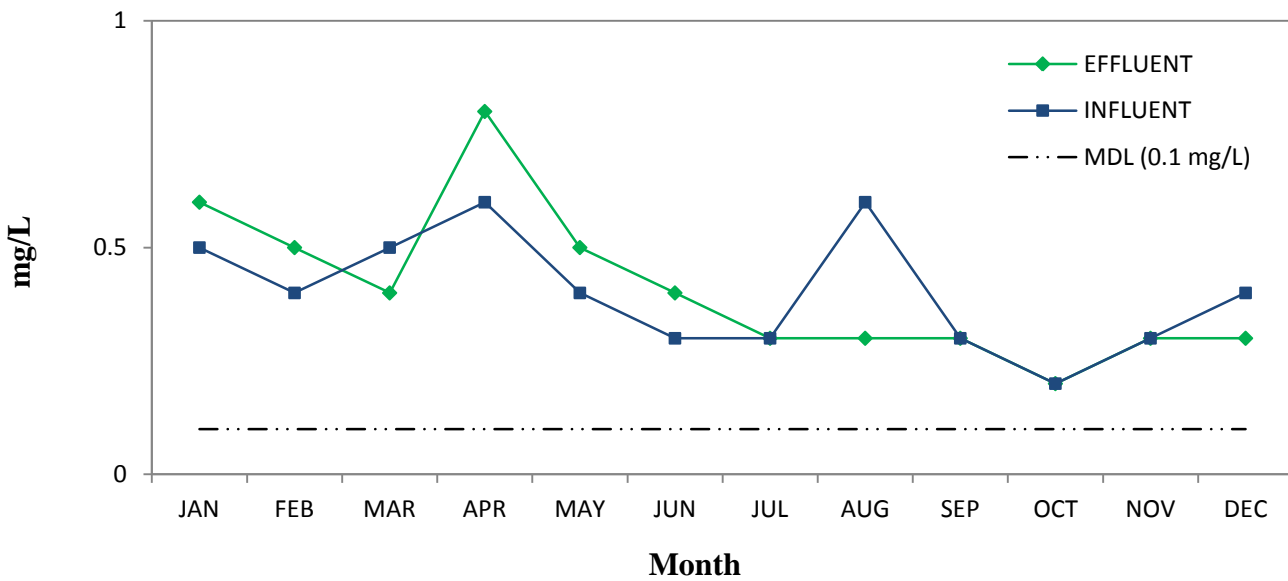

**2013 South Bay Water Reclamation Plant  
Monthly Averages**

**Chloride**

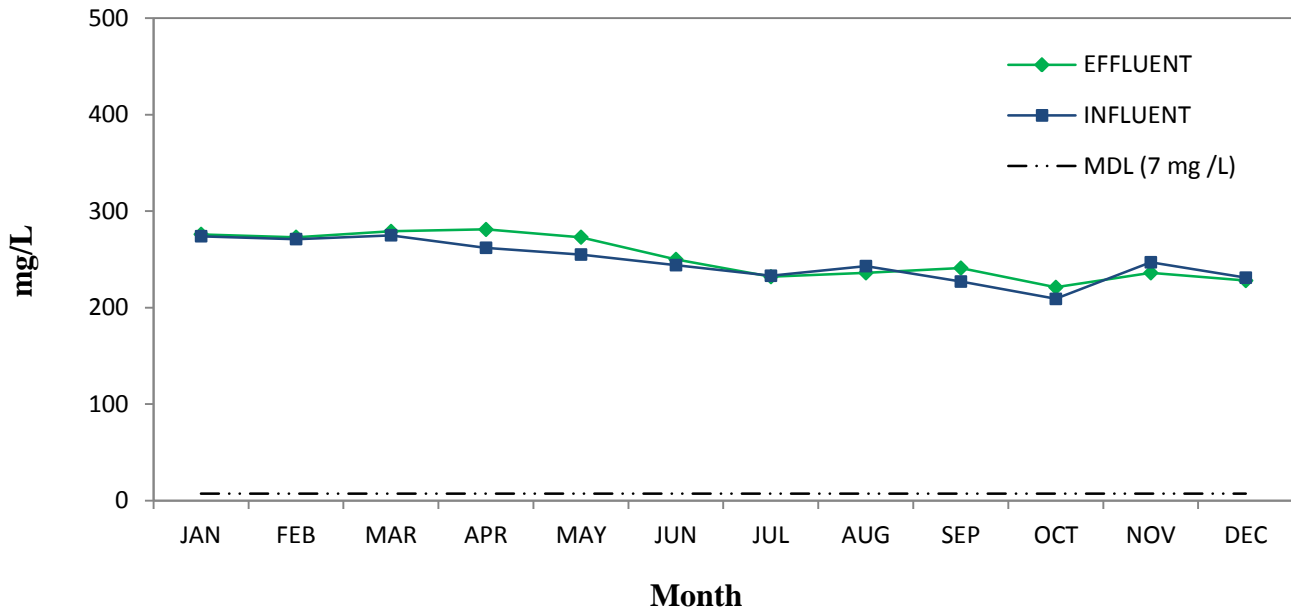

**Fluoride**

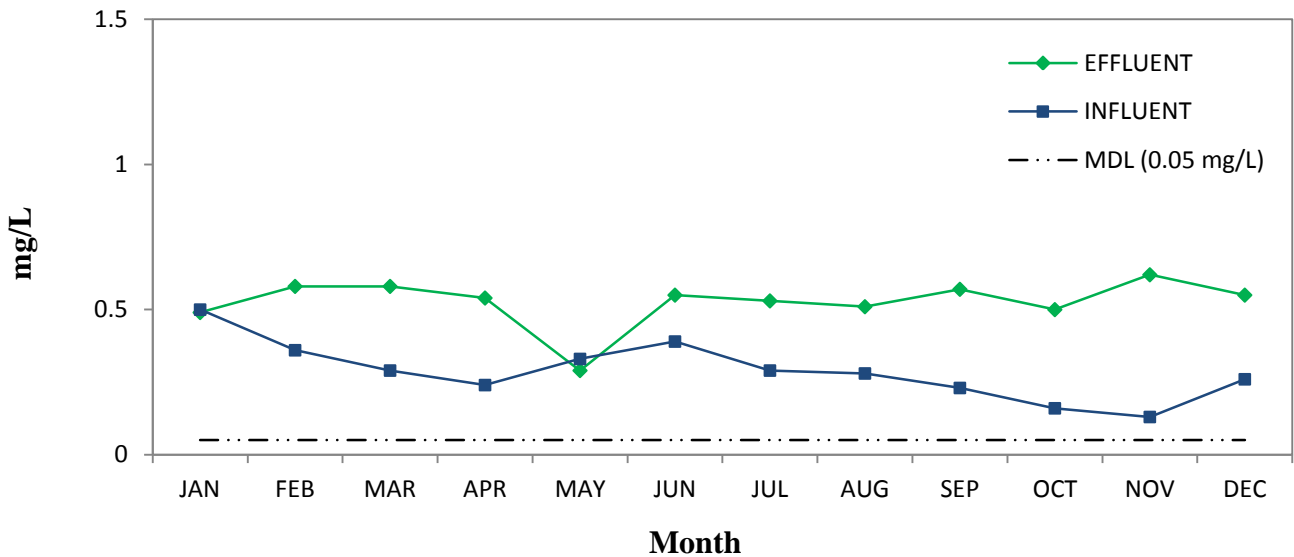

**2013 South Bay Water Reclamation Plant  
Monthly Averages**

**Nitrate**

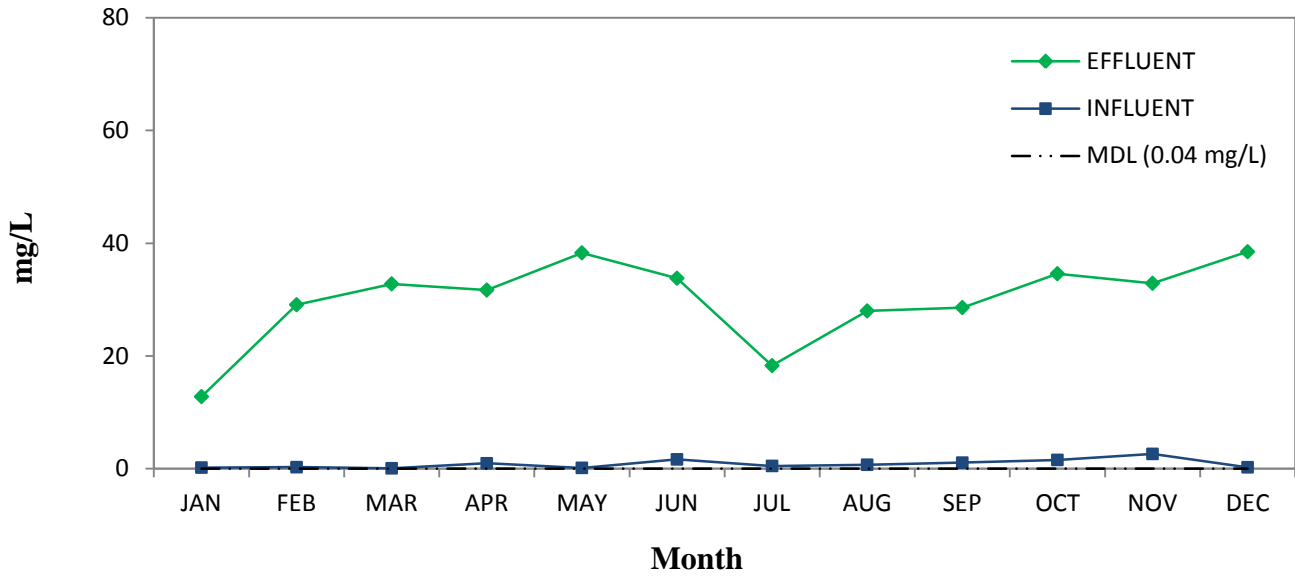

**O-Phosphate**

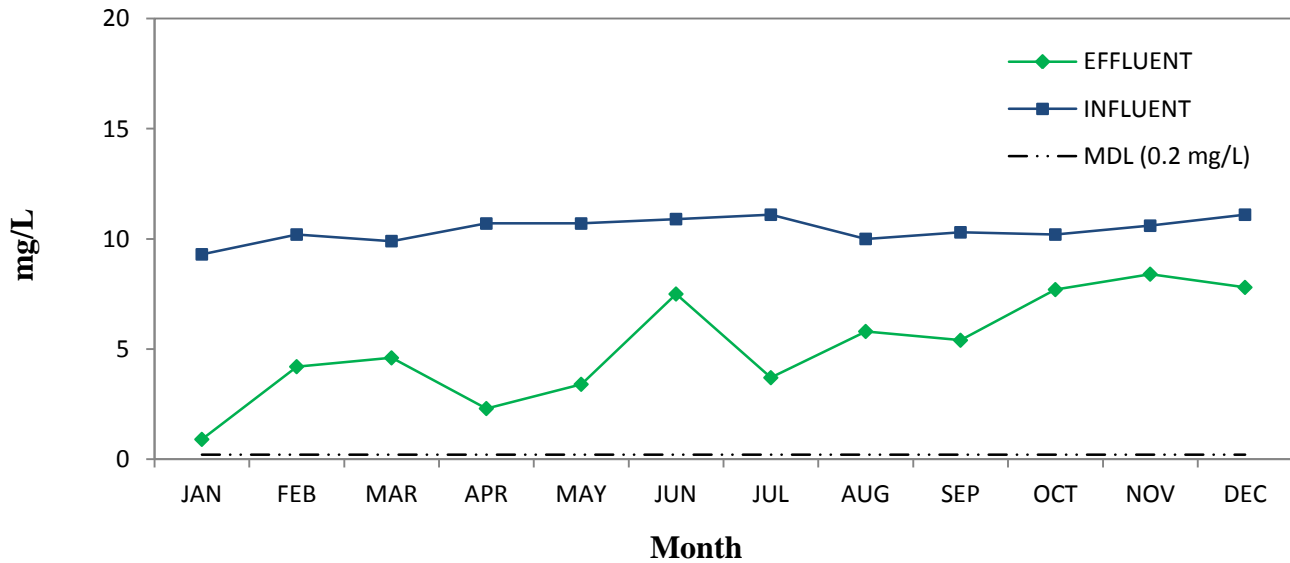

2013 South Bay Water Reclamation Plant  
Monthly Averages

Sulfate

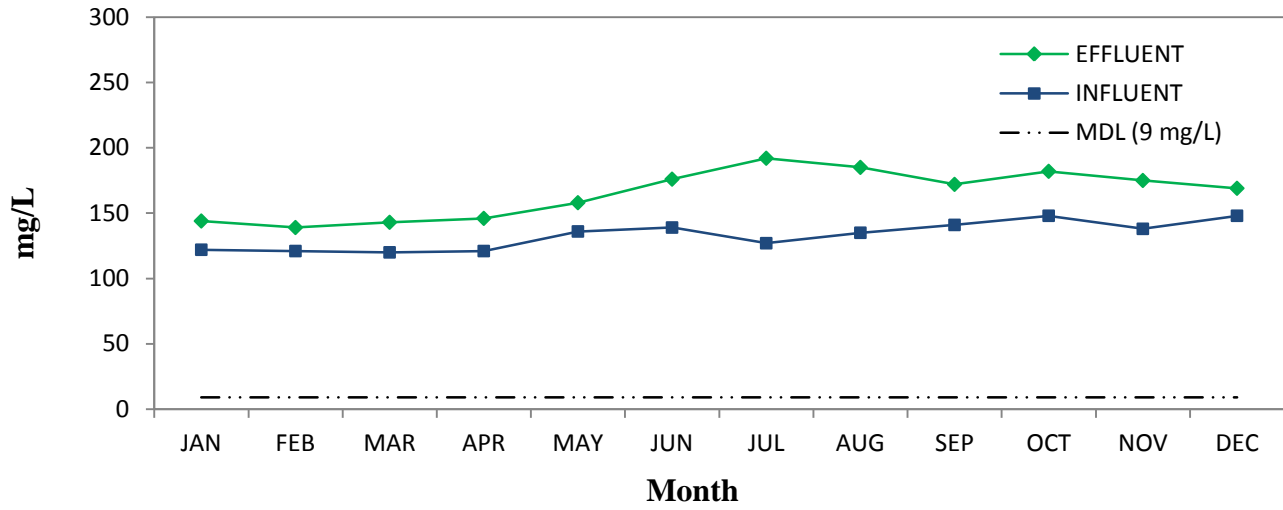



E. Daily Values of Selected Parameters.

Daily values of selected parameters (e.g., TSS, Flow, TSS Removals, etc.) are tabulated and presented graphically; statistical summary information is provided.

# South Bay Wastewater Reclamation Plant 2013 Total Suspended Solids

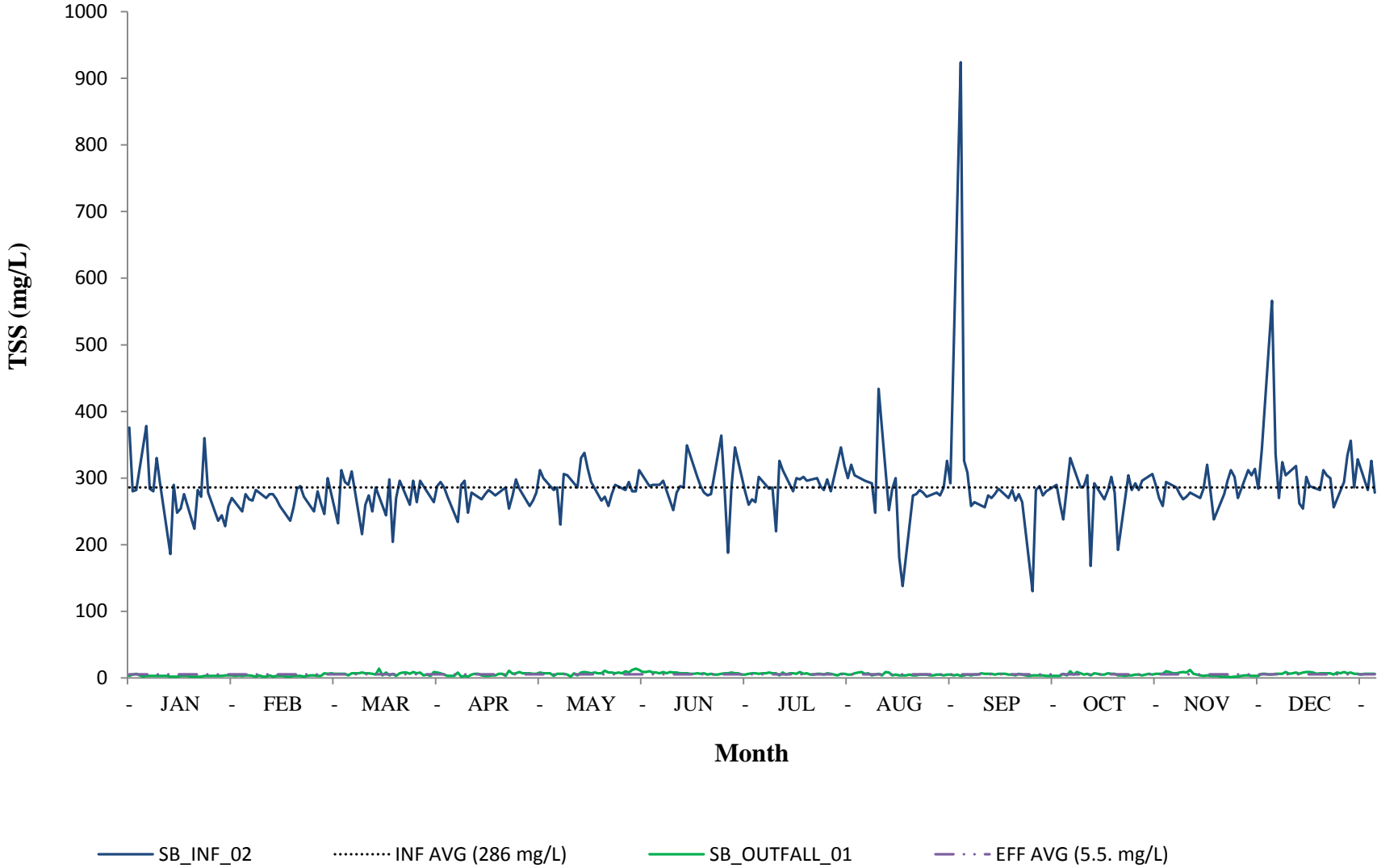

## 2013 Total Suspended Solids

Day	Jan		Feb		Mar		Apr		May		Jun		Jul		Aug		Sep		Oct		Nov		Dec			
	INF	EFF	INF	EFF	INF	EFF	INF	EFF	INF	EFF	INF	EFF	INF	EFF	INF	EFF	INF	EFF	INF	EFF	INF	EFF	INF	EFF		
1	376	3.0		3.0		7.0	288	8.0	312	8.0		9.0	260	6.0	304	7.0	924	3.0	238	6.0		9.0	566	5.0		
2	280	5.0		4.0		6.0	294	7.0	300	7.0	288	10.0	268	7.0		8.0	326	4.0	286	4.0		7.0	336	6.0		
3	282	6.0	250	3.0	232	6.0	286	5.0		7.0	290	8.0	264	7.0		9.0	308	5.0	330	10.0	286	7.0	270	6.0		
4		4.0	276	4.0	312	6.0	272	3.0		7.0	290	8.0	302	6.0	296	6.0	258	4.0		5.0	276	8.0	324	6.0		
5		2.0	268	4.0	294	6.0		3.0	282	3.0	290	7.0		7.0	294	7.0	264	5.0		9.0	268	9.0	304	9.0		
6	378	3.0	266	3.0	290	4.0		3.0	286	6.0	296	9.0		7.0	292	4.0		5.0	286	7.0	272	8.0		6.0		
7	284	3.0	282	2.0	310	7.0	234	8.0	230	6.0		7.0	284	8.0	248	5.0		7.0	288	5.0	278	12.0		7.0		
8	280	3.0		4.0		7.0	290	2.0	306	6.0		9.0	286	7.0	434	6.0	256	6.0	304	6.0		6.0	318	8.0		
9	330	3.0		2.0		7.0	296	3.0	304	5.0	252	8.0	220	7.0		4.0	274	6.0	168	4.0		5.0	262	6.0		
10	292	3.0	270	2.0	216	8.0	248	2.0		2.0	278	8.0	326	4.0		9.0	270	6.0	292	7.0	270	4.0	254	8.0		
11		3.0	276	4.0	260	7.0	278	5.0		7.0	288	7.0	312	8.0	252	8.0	276	5.0		6.0	284	3.0	302	9.0		
12		3.0	276	2.0	274	7.0		6.0	286	4.0	286	7.0		5.0	284	4.0	284	6.0		5.0	320	4.0	288	9.0		
13	186	2.0	268	3.0	250	6.0		6.0	330	8.0	349	7.0		7.0	300	5.0		6.0	268	5.0	280	3.0		8.0		
14	290	2.0	258	3.0	286	5.0	268	4.0	338	9.0		6.0	280	7.0	180	4.0		6.0	282	7.0	238	3.0		6.0		
15	248	2.0		3.0		14.0	276	3.0	314	8.0		6.0	300	6.0	138	4.0	270	5.0	302	6.0		3.0	282	7.0		
16	254	3.0		2.0		4.0	282	3.0	294	7.0	302	7.0	298	9.0		4.0	282	5.0	278	6.0		2.0	312	7.0		
17	276	3.0	236	2.0	244	8.0	278	4.0		8.0	288	6.0	302	6.0		5.0	266	4.0	192	4.0	276	2.0	304	7.0		
18		3.0	256	3.0	298	4.0	274	4.0		7.0	278	7.0	296	7.0	274	4.0	276	6.0		4.0	296	2.0	300	7.0		
19		2.0	284	3.0	204	6.0		6.0	266	7.0	274	5.0		5.0	276	4.0	264	5.0		3.0	312	1.0	256	5.0		
20	224	2.0	288	3.0	270	3.0		6.0	272	11.0	276	6.0		5.0	282	5.0		4.0	304	4.0	302	2.0		8.0		
21	282	2.0	272	2.0	296	7.0	286	3.0	258	8.0		5.0	300	6.0	278	5.0		3.0	282	4.0	270	2.0		7.0		
22	272	2.0		3.0		8.0	254	11.0	276	8.0		5.0	288	6.0	272	5.0	130	4.0	292	5.0		3.0	294	9.0		
23	360	3.0		4.0		8.0	274	6.0	290	7.0	364	6.0	282	5.0		4.0	282	4.0	282	5.0		4.0	334	7.0		
24	278	3.0	250	4.0	260	6.0	298	7.0		8.0	282	7.0	298	7.0		4.0	288	4.0	296	4.0	312	4.0	356	8.0		
25		3.0	280	3.0	296	9.0	284	9.0		7.0	188	7.0	280	6.0	278	5.0	274	4.0		5.0	304	3.0	286	6.0		
26		3.0	262	3.0	264	7.0		7.0	282	10.0	284	8.0		5.0	274	5.0	280	3.0		6.0	314	3.0	328	6.0		
27	236	3.0	246	7.0	296	8.0		7.0	294	8.0	346	7.0		4.0	286	4.0		3.0	306	5.0	284	3.0		5.0		
28	244	3.0	300	6.0	288	4.0	258	7.0	280	12.0		7.0	346	6.0	326	5.0		3.0	290	6.0	344	6.0		6.0		
29	228	4.0				5.0	266	6.0	280	14.0		5.0	318	6.0	292	5.0	290	3.0	270	6.0		6.0	282	6.0		
30	258	4.0				3.0	278	6.0	312	12.0	280	5.0	300	5.0		4.0	262	3.0	258	6.0		5.0	326	6.0		
31	270	4.0			264	9.0				9.0			320	5.0		5.0			294	10.0			278	6.0		
Ave	279	3.0	268	3.3	272	6.5	276	5.3	291	7.6	289	7.0	293	6.2	279	5.3	300	4.6	278	5.6	289	4.6	311	6.8	286	5.5
Min	186	2.0	236	2.0	204	3.0	234	2.0	230	2.0	188	5.0	220	4.0	138	4.0	130	3.0	168	3.0	238	1.0	254	5.0	130	1.0
Max	378	6.0	300	7.0	312	14.0	298	11.0	338	14.0	364	10.0	346	9.0	434	9.0	924	7.0	330	10.0	344	12.0	566	9.0	924	14.0

# South Bay Wastewater Reclamation Plant 2013 TSS Percent Removal

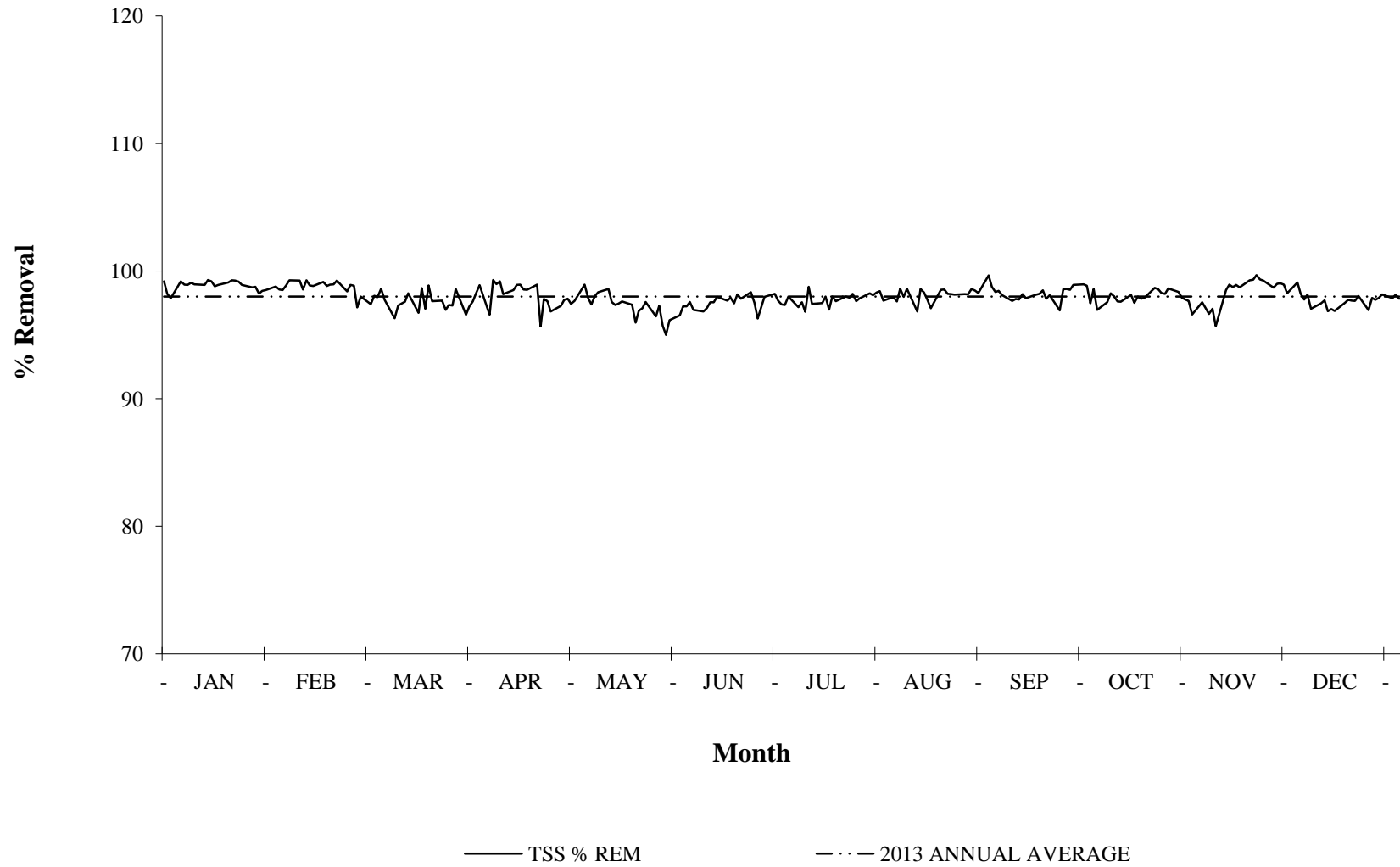

## 2013 TSS Percent Removals

Day	Jan	Feb	Mar	Apr	May	Jun	Jul	Aug	Sep	Oct	Nov	Dec	
1	99.2			97.2	97.4		97.7	97.7	99.7	97.5		99.1	
2	98.2			97.6	97.7	96.5	97.4		98.8	98.6		98.2	
3	97.9	98.8	97.4	98.3		97.2	97.3		98.4	97.0	97.6	97.8	
4		98.6	98.1	98.9		97.2	98.0	98.0	98.4		97.1	98.1	
5		98.5	98.0		98.9	97.6		97.6	98.1		96.6	97.0	
6	99.2	98.9	98.6		97.9	97.0		98.6		97.6	97.1		
7	98.9	99.3	97.7	96.6	97.4		97.2	98.0		98.3	95.7		
8	98.9			99.3	98.0		97.6	98.6	97.7	98.0		97.5	
9	99.1			99.0	98.4	96.8	96.8		97.8	97.6		97.7	
10	99.0	99.3	96.3	99.2		97.1	98.8		97.8	97.6	98.5	96.9	
11		98.6	97.3	98.2		97.6	97.4	96.8	98.2		98.9	97.0	
12		99.3	97.4		98.6	97.6		98.6	97.9		98.8	96.9	
13	98.9	98.9	97.6		97.6	98.0		98.3		98.1	98.9		
14	99.3	98.8	98.3	98.5	97.3		97.5	97.8		97.5	98.7		
16	99.2			98.9	97.5		98.0	97.1	98.1	98.0		97.5	
16	98.8			98.9	97.6	97.7	97.0		98.2	97.8		97.8	
17	98.9	99.2	96.7	98.6		97.9	98.0		98.5	97.9	99.3	97.7	
18		98.8	98.7	98.5		97.5	97.6	98.5	97.8		99.3	97.7	
19		98.9	97.1		97.4	98.2		98.6	98.1		99.7	98.0	
20	99.1	99.0	98.9		96.0	97.8		98.2		98.7	99.3		
21	99.3	99.3	97.6	99.0	96.9		98.0	98.2		98.6	99.3		
22	99.3			95.7	97.1		97.9	98.2	96.9	98.3		96.9	
23	99.2			97.8	97.6	98.4	98.2		98.6	98.2		97.9	
24	98.9	98.4	97.7	97.7		97.5	97.7		98.6	98.6	98.7	97.8	
25		98.9	97.0	96.8		96.3	97.9	98.2	98.5		99.0	97.9	
26		98.9	97.3		96.5	97.2		98.2	98.9		99.0	98.2	
27	98.7	97.2	97.3		97.3	98.0		98.6		98.4	98.9		
28	98.8	98.0	98.6	97.3	95.7		98.3	98.5		97.9	98.3		
29	98.2			97.7	95.0		98.1	98.3	99.0	97.8		97.9	
30	98.4			97.8	96.2	98.2	98.3		98.9	97.7		98.2	
31	98.5		96.6				98.4			96.6		97.8	Annual Summary
<b>Average</b>	98.9	98.8	97.6	98.1	97.3	97.5	97.8	98.1	98.3	97.9	98.4	97.7	98.0
<b>Minimum</b>	97.9	97.2	96.3	95.7	95.0	96.3	96.8	96.8	96.9	96.6	95.7	96.9	95.0
<b>Maximum</b>	99.3	99.3	98.9	99.3	98.9	98.4	98.8	98.6	99.7	98.7	99.7	99.1	99.7

## South Bay Wastewater Reclamation Plant 2013 Biochemical Oxygen Demand

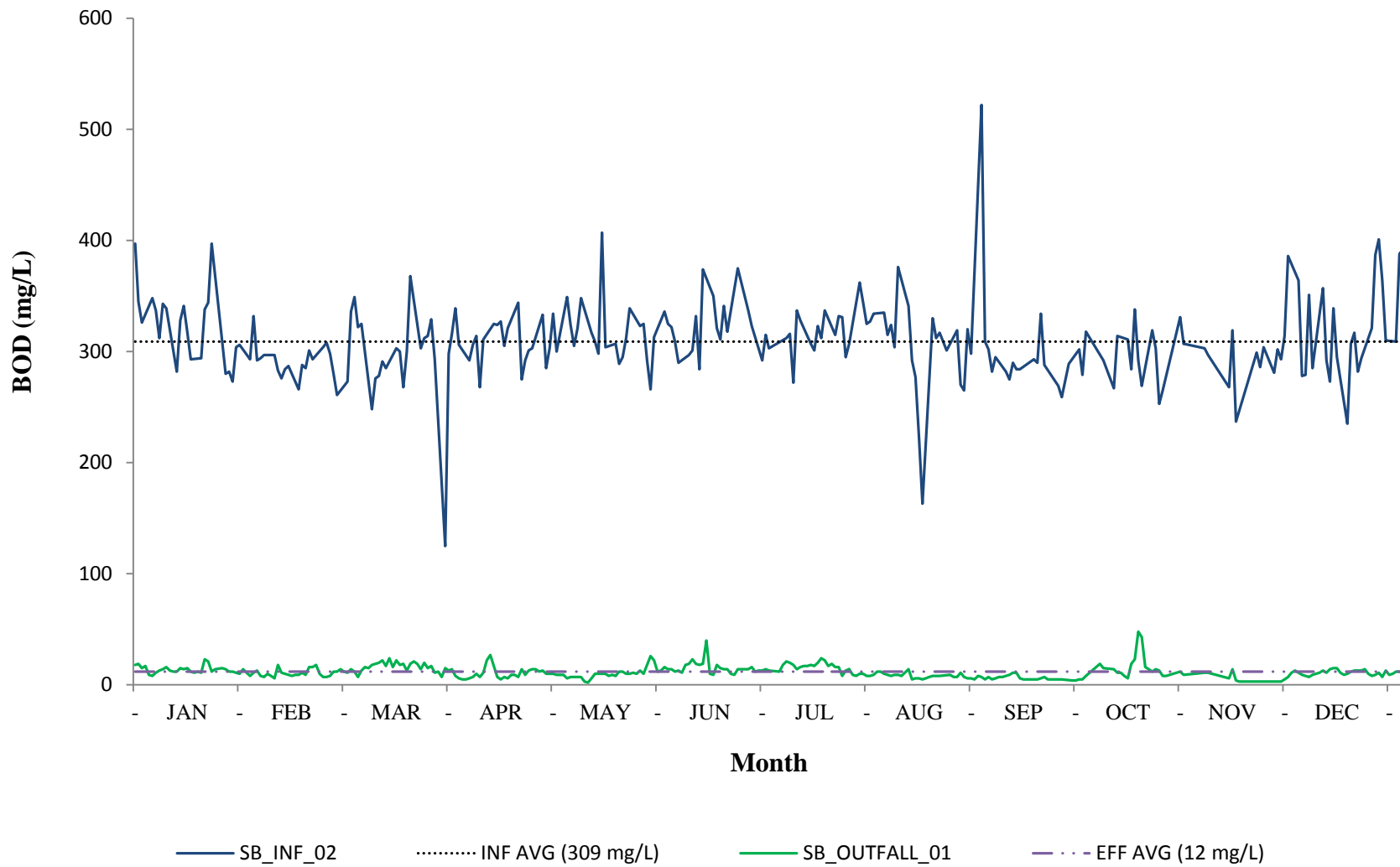

## 2013 Biochemical Oxygen Demand

Day	Jan		Feb		Mar		Apr		May		Jun		Jul		Aug		Sep		Oct		Nov		Dec			
	INF	EFF	INF	EFF	INF	EFF	INF	EFF	INF	EFF	INF	EFF	INF	EFF	INF	EFF	INF	EFF	INF	EFF	INF	EFF	INF	EFF		
1	397	18		14		14	298	13	334	10		13	315	14	334	9	522	7	318	8			364	11		
2	345	19		11		12	316	14	300	9		16	303	13		12	309	5					278	9		
3	326	15	293	8	273	11	339	8		9		14				12	302	7					279	8		
4		17	332	11	336	14	306	6		9		14			335	10	282	5			303	11	351	7		
5		9	292	13	349	12		5	349	6	309	12		12	315	9	295	6		19	297	11	285	9		
6	348	8	294	8	322	7		5	324	7	290	13		18	324	8		7	292	15						
7	337	11	297	7	325	13	292	6	305	7		11	312	21	304	9		7						11		
8	312	13		10		16	306	7	321	7		18	316	20	376	9	282	8					357	13		
9	343	14		8		15	314	10	348	7	297	19	272	18		8	275	9	267	14			292	11		
10	339	16	297	6	248	18	268	7		3	301	23	337	14			290	11	314	11			273	14		
11		13	283	18	276	19	311	11		2	332	19	328	16	341	14	284	11		11	268	6	339	15		
12		12	276	11	278	20		22	317	6	284	18		17	292	5	284	6		8	319	14	295	15		
13	282	12	284	10	291	22		27	309	10	374	19		17	277	6		5	311	6	237	4		11		
14	328	15	287	9	285	17	325	17	298	10		40	307	18	223	6			284	19		3		9		
15	341	14		8		24	324	7	407	10		10	301	17	163	5			338	23			235	10		
16	318	15		9		16	327	5	304	10	350	9	323	20		6	293	5	292	48			307	12		
17	293	12	266	9	303	22	305	7		8	321	18	312	24		7	290	5	269	43			317	13		
18		11	288	11	300	18	321	6		9	311	15	337	22	330	8	334	6		16			282	13		
19		12	285	9	268	19		9	307	8	341	14		17	312	8	288	7		14	299		294	13		
20	294	11	301	16	300	13		9	289	12	318	14		19	317	8		5	319	12	286			14		
21	338	23	293	16	368	19	344	7	295	12		10	315	16					303	14	304			10		
22	344	21		18		21	275	14	312	10		9	332	16	301				253	13			321	8		
23	397	12		10		19	292	9	339	10	375	14	331	8		9	269	5	265	8			387	9		
24		14	304	7	303	14	301	13		11			295	13		7	259	5		8	281	3	401	11		
25			308	7	312	20	303	14		10			307	14	319	7					302	3	364	7		
26		15	298	8	314	15		14	323	13	337	14		9	270	11	289				293	3	310	13		
27	280	14	280	12	329	17		12	325	10	323	16		8	265	7		4			314	5		9		
28	282	12	261	12	293	11	333	13	292	18		12	362	10	320	6		4	331	12	386	7		10		
29	273	12				12	285	10	266	26		13	344	10	298	6	302	5	307	9			309	12		
30	304	11				7	303	10	313	22	292	13	325	8		5	279	5				13	388	12		
31	306	10			125	15				12			327	8		8							392	11		
<b>Avg</b>	324	14	291	11	295	16	309	11	317	10	323	15	319	15	301	8	301	6	292	16	299	7	323	11	309	12
<b>Min</b>	273	8	261	6	125	7	268	5	266	2	284	9	272	8	163	5	259	4	253	6	237	3	235	7	125	2
<b>Max</b>	397	23	332	18	368	24	344	27	407	26	375	40	362	24	376	14	522	11	338	48	386	14	401	15	522	48

Annual Summary  
INF EFF

# South Bay Wastewater Reclamation Plant 2013 BOD Percent Removal

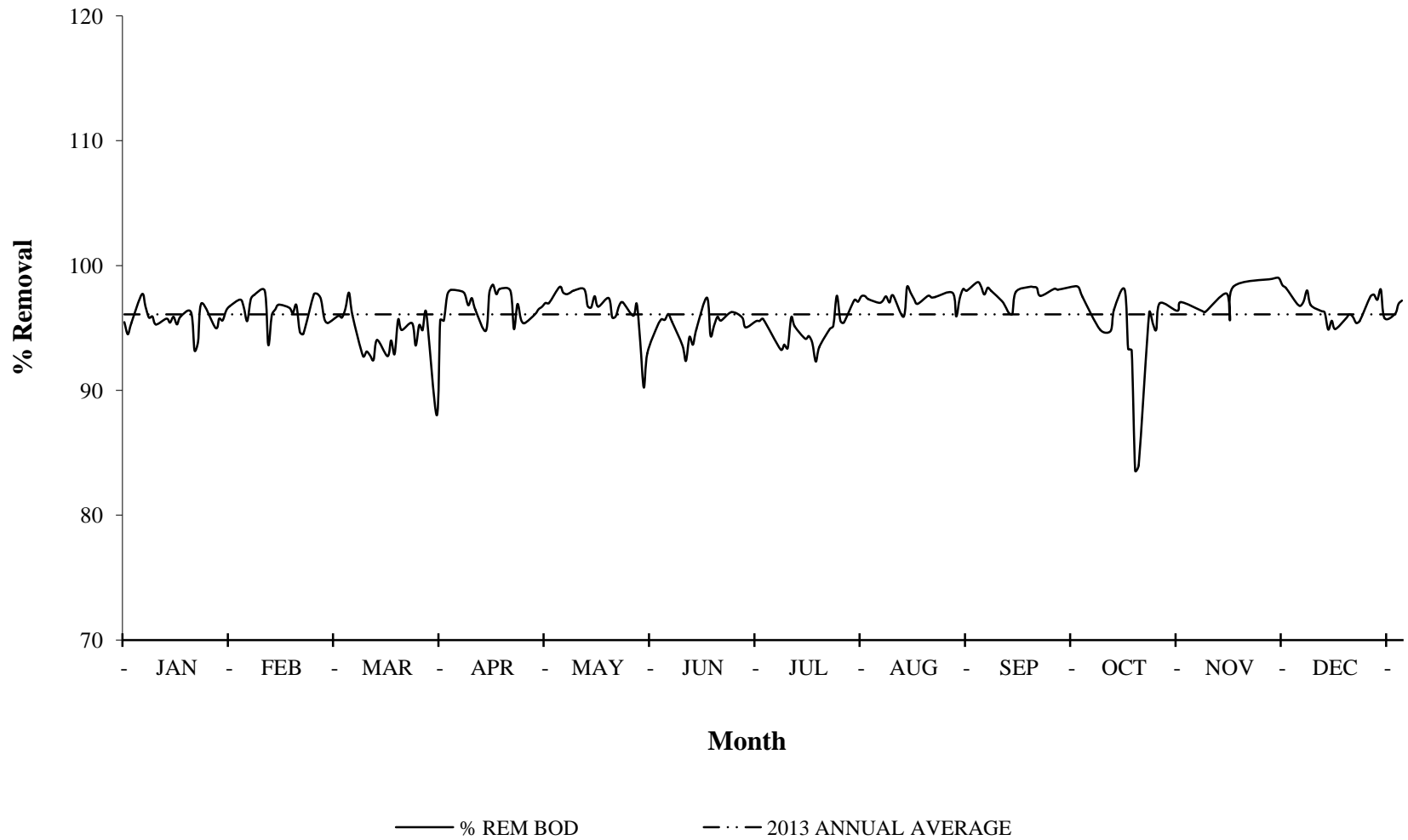



## 2013 BOD Percent Removals

Day	Jan	Feb	Mar	Apr	May	Jun	Jul	Aug	Sep	Oct	Nov	Dec	
1	95.5			95.6	97.0		95.6	97.3	98.7	97.5		97.0	
2	94.5			95.6	97.0	95.2	95.7		98.4			96.8	
3	95.4	97.3	96.0	97.6		95.7			97.7			97.1	
4		96.7	95.8	98.0		95.7		97.0	98.2		96.4	98.0	
5		95.5	96.6		98.3	96.1		97.1	98.0		96.3	96.8	
6	97.7	97.3	97.8		97.8	95.5		97.5		94.9			
7	96.7	97.6	96.0	97.9	97.7		93.3	97.0					
8	95.8			97.7	97.8		93.7	97.6	97.2			96.4	
9	95.9			96.8	98.0	93.6	93.4		96.7	94.8		96.2	
10	95.3	98.0	92.7	97.4		92.4	95.8		96.2	96.5		94.9	
11		93.6	93.1	96.5		94.3	95.1	95.9	96.1		97.8	95.6	
12		96.0	92.8		98.1	93.7		98.3	97.9		95.6	94.9	
13	95.7	96.5	92.4		96.8	94.9		97.8		98.1	98.3		
14	95.4	96.9	94.0	94.8	96.6		94.1	97.3		93.3			
15	95.9			97.8	97.5		94.4	96.9		93.2		95.7	
16	95.3			98.5	96.7	97.4	93.8		98.3	83.6		96.1	
17	95.9	96.6	92.7	97.7		94.4	92.3		98.3	84.0		95.9	
18		96.2	94.0	98.1		95.2	93.5	97.6	98.2			95.4	
19		96.8	92.9		97.4	95.9		97.4	97.6			95.6	
20	96.3	94.7	95.7		95.8	95.6		97.5		96.2			
21	93.2	94.5	94.8	98.0	95.9		94.9			95.4			
22	93.9			94.9	96.8		95.2			94.9		97.5	
23	97.0			96.9	97.1	96.3	97.6		98.1	97.0		97.7	
24		97.7	95.4	95.7			95.6		98.1		98.9	97.3	
25		97.7	93.6	95.4			95.4	97.8			99.0	98.1	
26		97.3	95.2		96.0	95.8		95.9			99.0	95.8	
27	95.0	95.7	94.8		96.9	95.0		97.4			98.4		
28	95.7	95.4	96.2	96.1	93.8		97.2	98.1		96.4	98.2		
29	95.6			96.5	90.2		97.1	98.0	98.3	97.1		96.1	
30	96.4			96.7	93.0	95.5	97.5		98.2			96.9	
31	96.7		88.0				97.6					97.2	Annual Summary
<b>Average</b>	95.7	96.41	94.3	96.8	96.5	95.2	95.2	97.3	97.8	94.2	97.8	96.5	96.1
<b>Minimum</b>	93.2	93.64	88.0	94.8	90.2	92.4	92.3	95.9	96.1	83.6	95.6	94.9	83.6
<b>Maximum</b>	97.7	98.0	97.8	98.5	98.3	97.4	97.6	98.3	98.7	98.1	99.0	98.1	99.0

## F. Toxicity Testing: South Bay Water Reclamation Plant 2013

### INTRODUCTION

The City of San Diego's Toxicology Laboratory (CSDTL) conducted aquatic toxicity tests (bioassays) for the South Bay Water Reclamation Plant (SBWRP) as required by Order No. R9-2006-0067 from Jan 1–April 3, 2013 and by Order No. R9-2013-0006 thereafter (NPDES Permit No. CA0109045). The testing requirements are designed to determine the acute and chronic toxicity of effluent samples collected from the SBWRP. In accordance with the above Orders, the City also conducted toxicity tests of the combined effluent samples for the SBWRP and adjacent International Wastewater Treatment Plant (IWTP). This chapter presents summaries and discussion of all toxicity tests conducted in calendar year 2013.

Toxicity testing of wastewater effluent measures the bioavailability of toxicants in a complex mixture, accounts for interactions among potential toxicants, and integrates the effects of all constituents. Acute and chronic bioassays are characterized by the duration of exposure of test organisms to a toxicant as well as the adverse effect (measured response) produced as the result of exposure to a toxicant.

Acute toxicity testing consists of a short-term exposure period, usually 96 hours or less, and the acute effect refers to mortality of the test animals. In 2013, acute toxicity test frequencies were updated in accordance with permit requirements.

#### Acute Toxicity Test Frequency

	<u>SBWRP</u>	<u>IWTP/SBWRP Combined Effluent</u>
Order No. R9-2006-0067	Quarterly	Quarterly
Order No. R9-2013-0006	Monthly	Quarterly

Chronic toxicity testing, in the classic sense, refers to long-term exposure of the test organism to a potential toxicant. This may involve exposing the test organism for its entire reproductive life cycle, which may exceed 12 months for organisms such as fish. In general, chronic tests are inherently more sensitive to toxicants than acute tests in that adverse effects are detected at lower toxicant concentrations. In 2013, chronic toxicity test frequencies were updated in accordance with permit requirements.

#### Chronic Toxicity Test Frequency

	<u>SBWRP</u>	<u>IWTP/SBWRP Combined Effluent</u>
Order No. R9-2006-0067	Not Required	Annual
Order No. R9-2013-0006	Quarterly	Quarterly

# MATERIALS & METHODS

## Test Materials

### *SBWRP Effluent*

Twenty-four hour, flow-weighted, effluent composite samples were collected at the in-stream sampling site (designated SB\_Outfall\_00) for the SBWRP and stored at 4 °C until test initiation. All tests were initiated within 36 hours of sample collection. The effluent exposure series consisted of 3.88, 7.75, 15.5, 31.0, and 62.0% (nominal) for the acute tests, and 0.26, 0.53, 1.05, 2.10, and 4.20% for the chronic tests. Dilution water for all tests (effluent and reference toxicant) was obtained from the Scripps Institution of Oceanography (SIO), filtered, held at 15 °C, and used within 96 hours of collection or frozen to produce hypersaline brine. Detailed descriptions for all toxicity tests are provided in the City of San Diego Toxicology Laboratory Quality Assurance Manual (City of San Diego 2012).

### *Combined Effluent*

Composite samples for these bioassays were collected during overlapping 24-hour sampling period by SBWRP and IWTP personnel at their respective facilities and combined in the laboratory in accordance with a ratio that is proportional to the flow from each treatment plant at the time of sample collection. The comingled effluent samples are hereinafter referred to as “Combined Effluent.”

The Combined Effluent samples were stored at 4°C and testing was initiated within 36 hours of sample collection. The effluent exposure series consisted of 3.88, 7.75, 15.5, 31.0, and 62.0% (nominal) for the acute tests and 0.26, 0.53, 1.05, 2.10, and 4.20% for the chronic tests. Dilution water for all tests (effluent and reference toxicant) was obtained from SIO, filtered, held at 15 °C, and used within 96 hours of collection or frozen to produce hypersaline brine. Detailed descriptions for all toxicity tests are provided in the City of San Diego Toxicology Laboratory Quality Assurance Manual (City of San Diego 2012).

## Acute Bioassays

### **Topsmelt Survival Bioassay**

During the current reporting period (January–December 2013), acute bioassays using the topsmelt, *Atherinops affinis*, were conducted once for the SBWRP effluent and twice for the Combined Effluent. For the SBWRP effluent, these tests were performed as the last of the routine monitoring program under No. R9-2006-0067. For the Combined Effluent, the first test was performed to fulfill the routine monitoring program under No. R9-2006-0067, and the second test was performed as a part of the multiple-species screening effort under Order No. R9-2013-0006. All tests were conducted in accordance with USEPA protocol EPA-821-R-02-012 (USEPA 2002).

Larval topsmelt (9–14 days old) were purchased from Aquatic Bio Systems (Fort Collins, CO), and acclimated to test temperature and salinity for at least 24 hours. Upon test initiation, the topsmelt (10 per replicate) were exposed for 96 hours in a static-renewal system to the effluent exposure series. Dilution water and brine controls were also tested. The test solutions were renewed at 48 hours and the organisms were fed once daily.

Simultaneous reference toxicant testing was performed using reagent grade copper chloride plus a negative control (i.e., SIO seawater). Test concentrations consisted of 56, 100, 180, 320, and 560 µg/L copper. Dilution water was obtained from SIO, filtered, held at 15 °C, and used within 96 hours of collection. Upon conclusion of the exposure period, percent survival was recorded. Tests were declared valid if control mortality did not exceed 10%. Data were analyzed using a multiple comparison and point estimation methods prescribed by USEPA (2002). ToxCalc (Tidepool Scientific Software 2002) and CETIS (Tidepool Scientific Software 2010) were used for all statistical analyses. In addition, all multi-concentration tests conducted according to EPA-821-R02-012 were subjected to an evaluation of the concentration-response relationship.

## **Mysid Survival Bioassay**

During the current reporting period (January–December 2013), acute bioassays using the mysid shrimp, *Mysidopsis bahia*, were conducted once for the Combined Effluent as a part of the multiple-species screening effort under Order No. R9-2013-0006. All tests were conducted in accordance with USEPA protocol EPA-821-R-02-012 (USEPA 2002).

Larval mysids (4–5 days old) were purchased from Aquatic Bio Systems (Fort Collins, CO), and acclimated to test temperature and salinity for at least 24 hours. Upon test initiation, the mysids (10 per replicate) were exposed for 96 hours in a static-renewal system to the effluent exposure series. Dilution water and brine controls were also tested. The test solutions were renewed at 48 hours and the organisms were fed once daily.

Simultaneous reference toxicant testing was performed using reagent grade copper chloride plus a negative control (i.e., SIO seawater). Test concentrations consisted of 56, 100, 180, 320, and 560 µg/L copper. Dilution water was obtained from SIO, filtered, held at 15 °C, and used within 96 hours of collection. Upon conclusion of the exposure period, percent survival was recorded. Tests were declared valid if control mortality did not exceed 10%. Data were analyzed using a combination of multiple comparison and point estimation methods prescribed by USEPA (2002). ToxCalc (Tidepool Scientific Software 2002) and CETIS (Tidepool Scientific Software 2010) were used for all statistical analyses. In addition, all multi-concentration tests conducted according to EPA-821-R02-012 were subjected to an evaluation of the concentration-response relationship.

## Chronic Bioassays

### ***Kelp Germination and Growth Tests***

During the current reporting period (January–December 2013), chronic bioassays using the giant kelp, *Macrocystis pyrifera*, were conducted for the Combined Effluent on a quarterly basis in accordance with USEPA protocol EPA/600/R-95/136 (USEPA 1995).

Kelp zoospores were obtained from the reproductive blades (sporophylls) of adult *Macrocystis* plants at the kelp beds near La Jolla, California one day prior to test initiation. The zoospores were exposed in a static system for 48 hours to the effluent exposure series. A SIO water control was also tested.

Simultaneous reference toxicant testing was performed using reagent grade copper chloride. The exposure series consisted of 5.6, 10, 18, 32, 100, and 180 µg/L copper. A SIO seawater control was also tested.

At the end of the exposure period, 100 randomly-selected zoospores from each replicate were examined and the percent germination was recorded. In addition, germ-tube length was measured and recorded for 10 of the germinated zoospores.

Data were analyzed in accordance with “Flowchart for statistical analysis of giant kelp, *Macrocystis pyrifera*, germination data” and “Flowchart for statistical analysis of giant kelp, *Macrocystis pyrifera*, growth data” (see USEPA 1995). ToxCalc (Tidepool Scientific Software 2002) and CETIS (Tidepool Scientific Software 2010) were used for all statistical analyses.

In accordance with USEPA guidelines on method variability, the lower “Percent MSD” (PMSD) bound was also evaluated in order to minimize Type 1 error (i.e., false positive). If the relative difference between an exposure concentration and the control was smaller than the 10<sup>th</sup> percentile PMSD value listed for the test method in the USEPA guidance document (i.e., 6.5 for germination and 7.9 for growth), then the exposure concentration was treated as if it did not differ significantly from control for the purpose of determining the NOEC (USEPA, 2000).

### ***Red Abalone Development Bioassay***

During the current reporting period (January–December 2013), chronic bioassays using the red abalone *Haliotis rufescens* were conducted for the SBWRP effluent on a monthly and quarterly basis under Order Nos. R9-2006-0067 and R9-2013-0006, respectively, in accordance with USEPA protocol EPA/600/R-95/136 (USEPA 1995).

Test organisms were purchased from Cultured Abalone (Goleta, California), and/or American Abalone Farm (Davenport, California), and shipped via overnight delivery to the CSDTL. Mature male and female abalones were placed in gender-specific natural seawater tanks and held at 15 °C. For each test event, spawning was induced in 6–10 abalones in gender-specific vessels. Eggs and sperm were retained and examined under magnification to ensure good quality. Once deemed acceptable, the sperm stock was used to fertilize the eggs, and a specific quantity of fertilized embryos was added to each test replicate and exposed to the effluent series for 48 hours. A SIO water control was also tested.

Simultaneous reference toxicant testing was performed using reagent grade zinc sulfate. The exposure series consisted of 10, 18, 32, 56, and 100 µg/L zinc. A SIO seawater control was also tested.

At the end of the exposure period, 100 randomly-selected embryos were examined and the number of normally and abnormally developed embryos was recorded. The percentage of normally developed embryos for each replicate was arcsine square root transformed. Data were analyzed in accordance with “Flowchart for statistical analysis of red abalone *Haliotis rufescens*, development data” (USEPA 1995). ToxCalc (Tidepool Scientific Software 2002) and CETIS (Tidepool Scientific Software 2010) were used for all statistical analyses.

The red abalone tests were scored both inclusive and exclusive of unicellular embryos, which can be indicative of poor animal quality. As shown in previous studies, the inclusive scoring method induced greater variability and reduced test sensitivity. Moreover, data from past and present studies showed no association between the distribution of unicellular embryos and exposure to the reference toxicant, which further support the use of the exclusive method in scoring the red abalone tests.

In accordance with USEPA guidelines on method variability, the lower “Percent MSD” (PMSD) bound was also evaluated in order to minimize Type 1 error (i.e., false positive). If the relative difference between an exposure concentration and the control was smaller than the 10<sup>th</sup> percentile PMSD value listed for the test method in the USEPA guidance document (i.e., 3.8), then the exposure concentration was treated as if it did not differ significantly from control for the purpose of determining the NOEC (USEPA, 2000).

### ***Purple Sea Urchin Fertilization Bioassay***

During the current reporting period (January–December 2013), chronic bioassays using the purple sea urchin, *Strongylocentrotus purpuratus*, were conducted for the SBWRP effluent as an alternate to the red abalone development bioassay during months in which gravid red abalones were potentially unavailable or of questionable quality. All tests were conducted in accordance with USEPA protocol EPA/600/R-95/136 (USEPA 1995).

Test organisms were obtained from the La Jolla kelp beds by City of San Diego personnel and delivered to the CSDTL immediately following collection. The urchins were evaluated for health and evidence of spawning prior to being placed in natural seawater tanks and held at 15 °C. For each test event, spawning was induced in at least six urchins and gametes from each animal were examined for quantity and quality. Whenever possible, eggs from at least two females and sperm from at least two males were used to create separate egg and sperm stocks. Density of the sperm and egg stocks were separately determine using a hemacytometer and a well slide, respectively.

Test initiation began upon delivery of 90,000 sperm into each test replicate. Following a 20-minute sperm-only exposure, 2,000 eggs were delivered into each test replicate and incubated for an additional 20 minutes to allow fertilization. A SIO seawater control was also tested.

Simultaneous reference toxicant testing was performed using reagent grade copper chloride. The exposure series consisted 10, 18, 32, 56, 100, and 180 µg/L copper. A SIO seawater control was also tested.

At the end of the test period, 100 randomly-selected eggs were examined and the number of fertilized and unfertilized eggs was recorded. The percentage of fertilized eggs for each replicate was arcsine square root transformed. Data were analyzed in accordance with “Flowchart for statistical analysis of sea urchin and sand dollar fertilization data” (USEPA 1995). ToxCalc (Tidepool Scientific Software 2002) and CETIS (Tidepool Scientific Software 2010) were used for all statistical analyses.

In accordance with USEPA guidelines on method variability, the lower “Percent MSD” (PMSD) bound was also evaluated in order to minimize Type 1 error (i.e., false positive). If the relative difference between an exposure concentration and the control was smaller than the 10<sup>th</sup> percentile PMSD value listed for the test method in the USEPA guidance document (i.e., 5.1), then the exposure concentration was treated as if it did not differ significantly from control for the purpose of determining the NOEC.

## **RESULTS & DISCUSSION**

### **Acute Toxicity of SBWRP Effluent**

In 2013, the City conducted acute bioassays of the SBWRP effluent using the topsmelt in accordance with Order No. R9-2006-0067. All valid tests met the test acceptability criterion and the NPDES permit’s acute toxicity performance goal (Table T.1).

### **Chronic Toxicity of SBWRP Effluent**

In 2013, the City conducted chronic bioassays of the SBWRP effluent using the red abalone and the purple sea urchin. All tests were conducted in accordance with the monthly and quarterly requirements under Order Nos. R9-2006-0067 and R9-2013-0006, respectively. All valid tests met the test acceptability criteria and the NPDES permit’s chronic toxicity performance goal (Table T.2).

### **Combined Effluent Toxicity**

The City also conducted quarterly acute and chronic bioassays for the Combined Effluent in 2013. Acute tests were conducted using the topsmelt and mysid shrimp and met the acceptability criterion (Table T.3). Chronic tests were conducted using the giant kelp. All tests met the acceptability criteria (Table T.4).

Although this combined effluent testing is a requirement of the SBWRP monitoring program, there are no compliance limits or performance goals for these data.

## REFERENCES

City of San Diego. 2012. Quality Assurance Manual. City of San Diego Ocean Monitoring Program, Metropolitan Wastewater Department, Environmental Monitoring and Technical Services Division, San Diego, CA

Tidepool Scientific Software. 2002. ToxCalc Toxicity Information Management System Database Software.

Tidepool Scientific Software. 2010. Comprehensive Environmental Toxicity Information System Software.

USEPA. 1995. Short-Term Methods for Estimating the Chronic Toxicity of Effluents and Receiving Waters to West Coast Marine and Estuarine Organisms. U.S. Environmental Protection Agency, Environmental Monitoring and Support Laboratory, Cincinnati, OH, EPA/600/R-95/136.

USEPA. 2000. Understanding and Accounting for Method Variability in Whole Effluent Toxicity Applications Under the National Pollutant Discharge Elimination System Program. U.S. Environmental Protection Agency, Office of Water (4203), EPA 833-R-00-003.

USEPA. 2002. Methods for measuring the acute toxicity of effluents and receiving waters to freshwater and marine organisms. Fifth Edition. U.S. Environmental Protection Agency, Office of Water (4303T), Washington, DC, EPA-821-R-02-012.



---

**Table T.1**

Results of SBWRP effluent acute toxicity tests conducted in 2013. Data are presented as acute toxic units (TUa).

Sample Date	Topsmelt 96-Hour Survival
03/18/2013	<1.52
N	1
No. in compliance	1
Mean TUa	<1.52

---

NPDES permit performance goal: 3.1 TUa.

**Table T.2**

Results of SBWRP effluent chronic toxicity tests conducted in 2013. Data are presented as chronic toxic units (TUc).

Sample Date	Red Abalone Development		Purple Urchin Fertilization
	Exclusive	Inclusive	
01/07/2013 <sup>a</sup>	23.8	23.8	-
01/14/2013 <sup>a</sup>	-	-	23.8
02/19/2013 <sup>a</sup>	23.8	23.8	23.8
03/11/2013 <sup>b</sup>	23.8	23.8	23.8
04/21/2013 <sup>b</sup>	23.8	23.8	23.8
06/10/2013 <sup>b</sup>	23.8	23.8	-
08/12/2013 <sup>b</sup>	23.8	23.8	-
10/15/2013 <sup>b</sup>	23.8	23.8	23.8
N	7	7	5
No. in compliance	7	7	5
Mean TUc	23.8	23.8	23.8

NPDES permit performance goals

<sup>a</sup> 95.6 TUc under Order No. R9-2006-0067 (Expired April 3, 2013)

<sup>b</sup> 96 TUc under Order No. R9-2013-0006 (Effective April 4, 2013)

---

**Table T.3**

Results of SBWRP/IWTP combined effluent acute toxicity tests conducted in 2013. Data are presented as acute toxic units (TUa).

Sample Date	Topsmelt 96-Hour Survival	Mysid 96-Hour Survival
02/11/2013	<1.50	-
05/20/2013	<1.52	<1.52

---

---

**Table T.4**

Results of SBWRP/IWTP combined effluent chronic toxicity tests conducted in 2013. Data are presented as chronic toxic units (TUc).

Sample Date	Giant Kelp	
	Germination	Growth
03/05/2013	23.8	23.8
06/04/2013	23.8	N.V.
06/25/2013	23.8	23.8
08/06/2013	23.8	23.8
10/23/2013	23.8	23.8

---

N.V.: Test not valid

### III. Plant Operations Summary

- A. Flows
- B. Rain Days
- C. Chemical Report
- D. Facilities Out of Service Report

This page is left blank intentionally.

# South Bay Water Reclamation Plant Treatment Process From Original Use to Ultimate Reuse

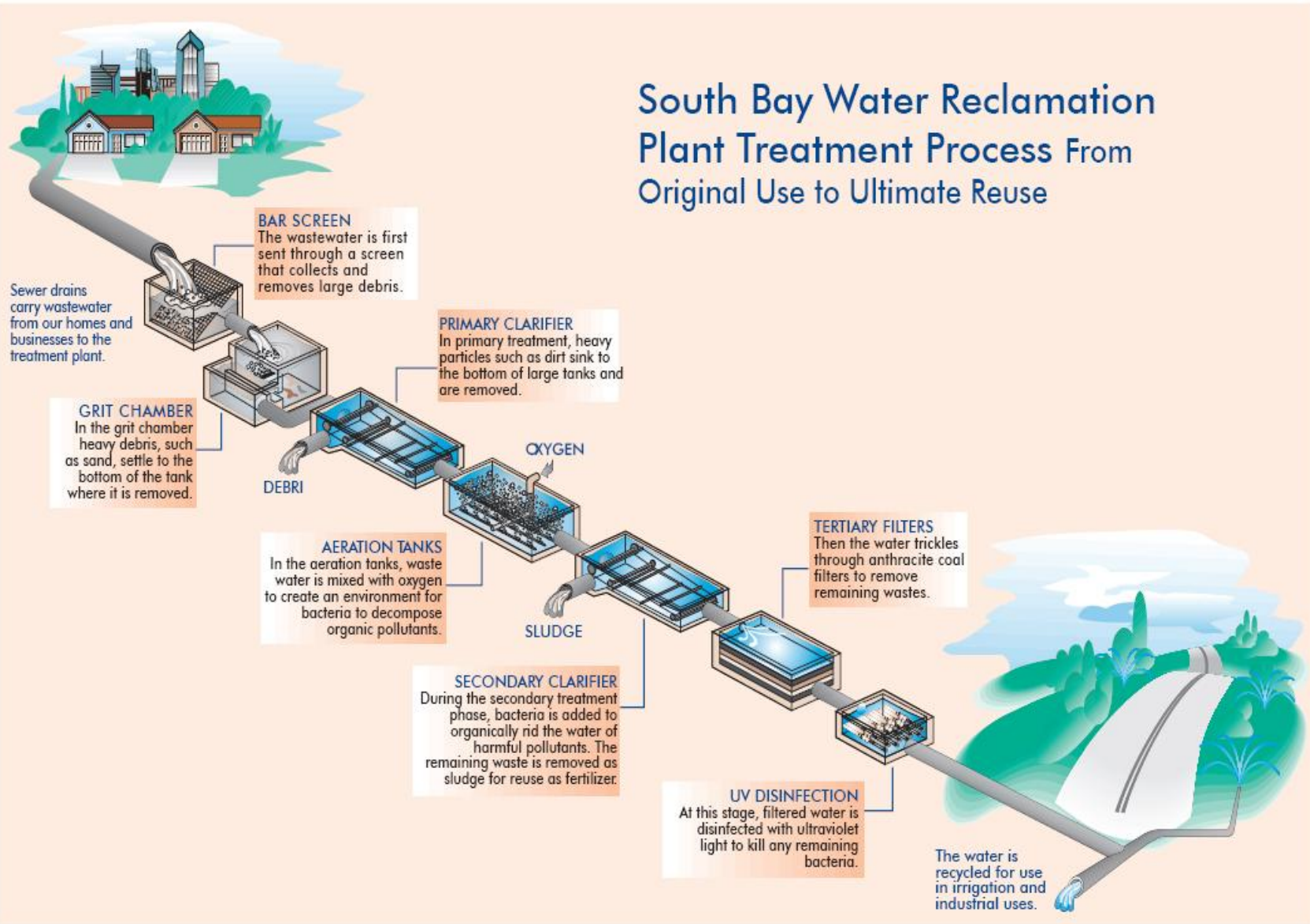

## Overview of the Wastewater Treatment Process

*Please see the treatment process flow diagram on the preceding page.*

Debris, large particulates, and sand are removed in the headworks by mechanical bar-screens and aerated grit removal systems. The process then consists of classical primary sedimentation and secondary treatment by activated sludge. While secondary effluent may be discharged directly to the ocean outfall the usual process directs the treated secondary effluent to reclamation and beneficial reuse by tertiary treatment and disinfection. Even if not beneficially reused, most of the flow goes through tertiary treatment. Tertiary treatment consists of filtration through Anthracite Coal Beds followed by disinfection with high intensity UV (ultraviolet) light. At this stage the "reclaimed" water meets California Title 22 full body contact requirements.

Untreated wastewater (Influent) enters the plant's Headworks from the South Bay region. In the Headworks, the wastewater passes through large, rake-like Bar Screens to remove solid debris and floating material (called "Rags") such as cloth, wood, and plastic material. These "rags" are dewatered and trucked to a landfill.

Following the headworks, the screened wastewater then passes through aerated Grit Chambers where heavier solids such as sand, gravel, coffee grounds and eggshells settle out and are removed. The grit is then dewatered and taken to landfills.

Wastewater then flows into the Primary Sedimentation Basins where the sedimentation process starts. Solids sink to the bottom of the tanks and "scum" (grease and cooking oils) float to the surface. "Raw Sludge" which has settled to the bottom of the basins is returned to the sewer system and sent to the Point Loma Wastewater Treatment Plant. Similarly, the scum is skimmed from the surface and returned to the sewer system.

The wastewater then enters Anoxic Zone Chambers that are oxygen depleted. The wastewater mixes with bacteria ("Bugs") that eat soluble organic material. The wastewater then flows into Aeration Basins where diffused air is pumped into the water. Here, the bugs begin to ingest and digest the organic solids while increasing in number and density.

Wastewater flows from the Aeration Basin into the Secondary Clarifiers where the bacteria and digested solids settle to the bottom as "Secondary Sludge." Some of this Sludge and any remaining scum are removed and returned to the sewer system for treatment at the Point Loma Wastewater Treatment Plant. The remaining sludge is returned to the Anoxic Basins and again mixed with the wastewater.

The water, now treated to a Secondary Treatment level, can either be discharged into the ocean through the South Bay Ocean Outfall or moved on to Tertiary Treatment for reclaimed water applications and beneficial reuse<sup>5</sup>.

In Tertiary Treatment, the treated wastewater (effluent) flows into Anthracite Coal Beds where it is filtered of remaining solids as it passes through the coal medium. The filtered water then passes through chambers where it is disinfected through exposure to high-intensity UV (ultraviolet) light.

---

<sup>5</sup> The Recycled Water Users Summary Report as described in Permit No. 2000-203 is submitted separately.



SBWRP Annual Monitoring Report  
2013 Flow Report

SBWRP FLOWS

(Million Gallons / Day)

Mon	Influent	Outfall	Secondary Effluent	Interceptor Return	South Metro Recycled Production	Distributed Recycled	Dilution Water Added Recycled	Recycled Plant Internal use
01	8.02	5.95	2.03	1.52	5.04	.46	.00	.67
02	8.17	5.85	1.88	1.54	5.30	.72	.00	.61
03	8.18	4.97	1.84	1.60	5.38	1.54	.00	.71
04	8.22	3.49	1.89	1.62	5.37	3.05	.00	.73
05	8.21	2.80	1.26	1.56	6.11	3.84	.00	.74
06	8.10	1.09	.46	1.72	6.76	5.29	.00	.84
07	8.14	1.14	.05	1.76	7.19	5.19	.00	.91
08	8.19	.89	.55	1.67	6.81	5.63	.00	.83
09	8.05	.89	.04	1.63	7.20	5.51	.00	.85
10	7.89	2.24	.12	1.75	6.94	3.95	.00	.88
11	7.91	4.34	1.70	1.51	5.37	1.97	.00	.76
12	7.86	5.01	2.99	1.52	4.00	1.24	.00	.75
avg	8.08	3.22	1.23	1.62	5.96	3.20	.00	.77

(Million Gallons / Month)

Mon	Influent	Outfall	Secondary Effluent	Interceptor Return	South Metro Recycled Production	Distributed Recycled	Dilution Water Added Recycled	Recycled Plant Internal use
01	248.68	184.33	62.86	47.24	156.39	14.18	.01	20.67
02	228.83	163.87	52.76	43.06	148.44	20.19	.03	17.16
03	253.59	154.18	56.93	49.57	166.82	47.62	.00	21.95
04	246.58	104.66	56.70	48.57	161.24	91.56	.01	21.79
05	254.49	86.67	39.11	48.51	189.43	119.11	.01	22.79
06	242.99	32.70	13.87	51.57	202.83	158.81	.00	25.27
07	252.31	35.43	1.69	54.60	222.97	160.92	.00	28.34
08	253.92	27.69	16.90	51.78	211.03	174.54	.00	25.71
09	241.49	26.64	1.27	48.83	216.05	165.22	.00	25.63
10	244.49	69.35	3.75	54.13	215.27	122.58	.00	27.15
11	237.40	130.15	51.03	45.19	161.05	59.10	.00	22.81
12	243.61	155.22	92.77	47.12	124.06	38.37	.00	23.16
avg	245.70	97.57	37.47	49.18	181.30	97.68	.01	23.54
sum	2948.38	1170.89	449.64	590.17	2175.58	1172.20	.06	282.43

A. Flows

<b>Effluent flows (mgd) 2013</b>													
Day	Jan	Feb	Mar	Apr	May	Jun	Jul	Aug	Sep	Oct	Nov	Dec	
1	6.27	6.80	4.13	3.07	2.44	0.82	0.34	0.36	3.49	0.94	6.26	6.13	
2	6.06	6.50	6.18	4.13	1.67	1.49	0.45	0.44	1.52	0.41	6.01	6.69	
3	6.44	6.28	6.17	3.24	1.64	0.79	0.18	0.29	0.15	0.04	5.70	6.51	
4	6.67	6.34	4.70	4.23	3.62	0.79	0.06	1.39	0.24	0.04	2.66	4.97	
5	5.97	5.10	2.93	4.20	5.78	0.64	0.08	2.59	0.15	0.04	1.58	6.56	
6	5.42	2.87	3.85	5.41	3.52	0.75	1.07	1.72	0.09	0.92	2.30	4.02	
7	6.82	4.93	3.83	6.20	5.98	0.65	5.65	2.35	0.05	1.18	2.38	3.03	
8	6.71	6.87	6.17	2.42	5.65	0.84	0.09	2.05	2.32	0.57	2.41	3.73	
9	6.44	6.29	6.54	2.53	4.13	6.09	0.35	0.93	2.04	1.45	2.35	6.55	
10	6.63	6.07	6.55	5.43	3.50	1.82	0.16	0.54	0.70	4.39	4.30	6.57	
11	6.43	6.51	6.64	5.05	4.27	0.54	0.13	0.77	0.16	4.63	4.00	6.49	
12	6.55	6.71	5.83	5.23	3.26	0.55	0.06	0.98	0.16	4.25	1.91	5.54	
13	6.12	6.79	6.83	5.63	2.15	1.30	2.13	0.76	0.07	5.68	2.60	5.53	
14	6.46	6.76	7.04	6.08	2.47	0.43	5.30	0.52	0.08	3.05	2.10	5.41	
15	5.80	6.15	7.04	3.42	4.70	0.47	0.11	0.57	3.15	1.58	1.15	5.73	
16	6.45	4.09	6.49	1.87	5.69	2.58	0.34	0.23	2.84	0.84	3.14	3.41	
17	6.39	3.83	6.15	1.61	2.87	2.08	0.05	0.34	0.74	0.70	6.01	3.28	
18	6.48	5.60	3.60	1.61	2.38	0.66	6.65	0.71	0.36	0.89	2.44	3.24	
19	6.37	5.62	2.29	2.51	1.47	0.55	3.16	1.72	0.10	0.67	6.58	3.37	
20	5.85	6.64	5.05	1.50	1.67	0.63	0.96	0.91	0.08	1.76	6.54	3.74	
21	5.58	6.64	6.15	3.81	1.78	0.42	0.34	1.02	0.08	2.43	3.03	6.31	
22	6.68	6.87	4.12	1.88	1.24	0.20	0.05	1.14	0.45	1.54	4.23	6.36	
23	3.91	6.86	1.79	4.59	0.76	2.21	0.10	1.24	1.42	4.24	6.34	6.58	
24	2.88	6.52	5.11	2.03	0.74	1.78	1.53	0.25	0.12	4.52	6.27	6.34	
25	2.93	6.63	3.70	5.31	0.70	0.58	0.07	0.06	0.32	0.64	6.28	6.01	
26	3.17	6.86	6.28	4.79	5.03	0.41	0.07	1.11	0.06	0.08	6.48	5.45	
27	6.56	3.86	4.01	1.50	2.92	1.22	0.13	1.36	0.06	2.24	6.56	4.28	
28	6.41	2.88	2.02	2.24	1.52	0.50	0.36	0.60	0.74	2.93	6.48	3.33	
29	6.37		3.15	1.52	1.27	0.49	1.43	0.54	2.85	6.52	6.06	3.17	
30	6.62		5.87	1.62	1.02	0.42	2.77	0.11	2.05	3.83	6.00	3.28	
31	6.89		3.97		0.83		1.26	0.09		6.35		3.61	
<b>Average</b>	5.95	5.85	4.97	3.49	2.80	1.09	1.14	0.89	0.89	2.24	4.34	5.01	3.21
<b>Minimum</b>	2.88	2.87	1.79	1.50	0.70	0.20	0.05	0.06	0.05	0.04	1.15	3.03	0.04
<b>Maximum</b>	6.89	6.87	7.04	6.20	5.98	6.09	6.65	2.59	3.49	6.52	6.58	6.69	7.04
<b>Total</b>	184.33	163.87	154.18	104.66	86.67	32.70	35.43	27.69	26.64	69.35	130.15	155.22	1,171

## Influent Flows (mgd) 2013

Day	Jan	Feb	Mar	Apr	May	Jun	Jul	Aug	Sep	Oct	Nov	Dec	
1	7.33	8.07	8.09	8.41	8.21	8.01	8.10	7.90	7.66	7.97	7.90	7.95	
2	8.10	8.06	7.99	8.45	8.55	7.97	8.45	8.37	8.24	7.87	7.48	8.11	
3	7.96	7.72	7.99	8.56	8.35	8.32	8.36	7.93	8.37	7.92	7.50	8.16	
4	8.11	8.32	8.27	8.61	8.11	8.41	7.65	7.93	8.40	7.91	8.08	8.16	
5	6.44	8.27	8.38	8.48	8.05	8.38	7.94	8.27	8.45	7.75	8.30	7.97	
6	7.64	8.44	8.5	8.03	8.15	8.43	7.75	8.29	8.27	7.57	8.26	7.90	
7	8.27	8.31	7.43	8.12	8.42	8.38	7.77	8.14	8.18	8.18	8.31	7.89	
8	8.19	8.23	8.86	7.86	8.44	8.04	8.29	8.70	7.94	8.16	8.19	8.09	
9	8.07	7.77	8.32	8.05	8.48	7.88	8.34	8.24	8.17	8.01	7.56	8.20	
10	7.92	7.88	8.32	8.51	8.27	8.15	8.34	7.71	8.24	8.05	6.31	8.12	
11	8.06	8.32	8.46	8.12	7.88	7.89	8.32	7.92	8.26	8.08	8.38	8.14	
12	7.77	8.38	8.55	8.08	7.85	8.38	8.36	8.28	8.21	7.71	7.93	7.98	
13	7.58	8.38	8.57	7.97	8.44	7.55	8.02	8.24	8.15	7.77	8.21	6.54	
14	7.85	8.05	8.55	8.10	8.59	8.11	8.02	8.28	7.87	8.11	8.51	7.42	
15	8.36	8.23	8.43	8.23	8.47	7.80	8.14	8.27	7.94	8.10	7.97	7.09	
16	8.35	7.71	7.98	8.43	8.41	7.69	7.82	8.30	7.95	8.08	7.76	7.79	
17	7.29	5.79	7.93	8.57	8.31	8.25	8.40	7.83	8.19	7.32	7.43	8.20	
18	8.08	8.03	8.38	8.45	7.94	8.17	8.19	8.03	8.24	7.86	8.07	8.13	
19	7.85	8.31	8.35	8.13	8.14	8.32	8.35	8.19	8.25	6.70	8.00	8.19	
20	7.43	8.60	8.5	8.02	8.33	8.34	7.90	8.27	8.16	7.86	8.09	8.03	
21	8.25	8.47	7.75	7.87	8.35	8.27	7.79	8.36	7.80	7.78	8.06	7.99	
22	8.32	8.37	8.36	8.27	8.45	7.78	8.20	8.38	7.64	8.06	8.13	7.89	
23	8.28	8.31	7.75	8.27	8.00	7.65	8.50	8.31	8.01	8.06	7.89	8.11	
24	8.29	8.11	7.54	8.15	8.35	8.14	8.54	7.86	7.99	8.01	7.65	7.97	
25	8.43	8.27	7.74	8.26	7.98	8.27	8.40	8.00	7.98	7.90	8.08	6.70	
26	8.33	7.95	8.46	8.27	6.94	8.05	7.86	8.25	8.02	7.58	8.07	7.83	
27	8.39	8.42	8.39	7.76	8.03	7.89	7.97	8.34	7.91	7.65	8.21	7.90	
28	8.30	8.17	8.21	7.87	8.31	8.39	8.00	8.39	7.62	8.03	7.89	7.71	
29	8.28		8.29	8.30	8.54	8.23	8.36	8.39	7.40	8.25	7.39	7.58	
30	8.36		7.48	8.38	7.85	7.85	7.87	8.50	7.98	8.17	7.79	7.97	
31	7.84		7.77		8.30		8.31	8.05		8.02		7.90	Annual Summary
<b>Average</b>	7.99	8.11	8.18	8.22	8.21	8.10	8.14	8.19	8.05	7.89	7.91	7.86	8.07
<b>Minimum</b>	6.44	5.79	7.43	7.76	6.94	7.55	7.65	7.71	7.40	6.70	6.31	6.54	5.79
<b>Maximum</b>	8.43	8.60	8.86	8.61	8.59	8.43	8.54	8.70	8.45	8.25	8.51	8.20	8.86
<b>Total</b>	247.72	226.94	253.59	246.58	254.49	242.99	252.31	253.92	241.49	244.49	237.40	243.61	2,946

## Blended Sludge Discharge to South Metro Interceptor (mgd) 2013

Day	Jan	Feb	Mar	Apr	May	Jun	Jul	Aug	Sep	Oct	Nov	Dec	
1	1.33	1.48	1.41	1.65	1.51	1.75	1.71	1.71	1.61	1.67	1.74	1.61	
2	1.43	1.36	1.66	1.60	1.64	1.67	1.93	1.73	1.60	1.69	1.65	1.36	
3	1.46	1.45	1.52	1.74	1.53	1.82	1.84	1.71	1.55	1.65	1.59	1.57	
4	1.40	1.55	1.44	1.65	1.46	1.76	1.71	1.70	1.70	1.77	1.64	1.41	
5	1.37	1.65	1.51	1.58	1.71	1.66	1.79	1.56	1.66	1.69	1.78	1.36	
6	1.56	1.54	1.53	1.52	1.64	1.55	1.68	1.78	1.71	1.69	1.79	1.64	
7	1.46	1.53	1.68	1.71	1.56	1.66	1.80	1.48	1.58	1.72	1.61	1.35	
8	1.37	1.56	1.43	1.62	1.57	1.70	1.70	1.79	1.68	1.61	1.59	1.46	
9	1.54	1.75	1.76	1.51	1.56	1.72	1.79	1.70	1.62	1.75	1.45	1.52	
10	1.42	1.35	1.56	1.62	1.79	1.59	2.02	1.87	1.63	1.68	1.64	1.39	
11	1.56	1.70	1.68	1.64	1.39	1.68	1.79	1.59	1.60	1.69	1.31	1.58	
12	1.46	1.52	1.48	1.58	1.45	1.65	1.86	1.61	1.61	1.81	1.52	1.46	
13	1.56	1.57	1.76	1.56	1.62	1.75	1.64	1.82	1.59	1.76	1.42	1.78	
14	1.37	1.56	1.59	1.63	1.51	1.60	1.84	1.63	1.57	1.76	1.00	1.44	
15	0.77	1.74	1.62	1.61	1.55	1.76	1.64	1.66	1.41	3.69	1.40	1.62	
16	1.65	1.39	1.59	1.50	1.50	1.69	1.58	1.65	1.72	1.80	1.38	1.46	
17	1.57	1.50	1.57	1.71	1.63	1.82	1.80	1.70	1.66	1.67	1.54	1.58	
18	1.56	1.61	1.64	1.60	1.44	1.69	1.66	1.77	1.65	1.67	1.45	1.57	
19	1.84	1.44	1.63	1.62	1.45	1.76	1.94	1.61	1.77	1.57	1.46	1.66	
20	1.71	1.55	1.66	1.62	1.75	1.67	1.79	1.65	1.78	1.60	1.50	1.56	
21	1.82	1.74	1.65	1.66	1.48	1.87	1.69	1.79	1.60	1.60	1.34	1.61	
22	1.68	1.44	1.54	1.63	1.58	1.73	1.79	1.67	1.61	1.66	1.53	1.52	
23	1.71	1.43	1.68	1.67	1.62	1.75	1.87	1.74	1.60	1.72	1.47	1.42	
24	1.57	1.62	1.59	1.67	1.51	1.74	1.89	1.71	1.70	1.63	1.49	1.54	
25	1.44	1.41	1.60	1.72	1.52	1.74	1.85	1.61	1.55	1.67	1.43	1.61	
26	1.34	1.58	1.61	1.65	1.63	1.83	1.67	1.57	1.67	1.59	1.51	1.36	
27	1.55	1.53	1.58	1.61	1.42	1.65	1.69	1.61	1.72	1.69	1.49	1.55	
28	1.82	1.51	1.53	1.60	1.55	1.85	1.68	1.41	1.55	1.68	1.60	1.46	
29	1.84		1.64	1.59	1.73	1.64	1.62	1.67	1.52	1.62	1.44	1.61	
30	1.81		1.66	1.50	1.48	1.82	1.75	1.68	1.61	1.60	1.43	1.45	
31	1.27		1.77		1.73		1.59	1.60		1.73		1.61	Annual Summary
<b>Average</b>	1.52	1.54	1.60	1.62	1.56	1.72	1.76	1.67	1.63	1.75	1.51	1.52	1.62
<b>Minimum</b>	0.77	1.35	1.41	1.50	1.39	1.55	1.58	1.41	1.41	1.57	1.00	1.35	0.77
<b>Maximum</b>	1.84	1.75	1.77	1.74	1.79	1.87	2.02	1.87	1.78	3.69	1.79	1.78	3.69
<b>Total</b>	47.24	43.06	49.57	48.57	48.51	51.57	54.60	51.78	48.83	54.13	45.19	47.12	590

# South Bay Wastewater Reclamation Plant 2013 Daily Flows

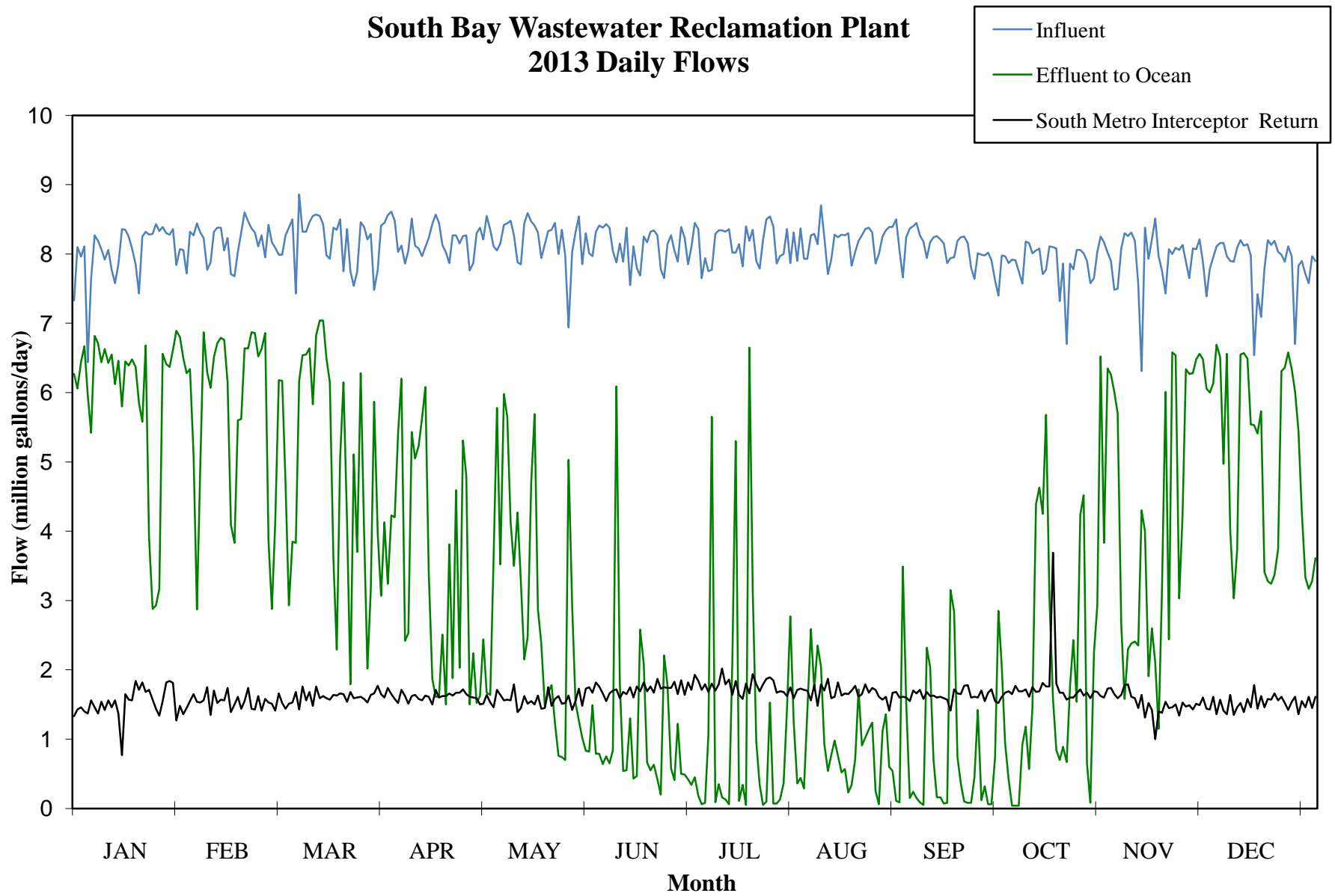

# South Bay Water Reclamation Plant

## Influent Dry Weather Flows (mgd) 2013

Day	Jan	Feb	Mar	Apr	May	Jun	Jul	Aug	Sep	Oct	Nov	Dec	
1	7.33	8.07	8.09	8.41	8.21	8.01	8.10	7.90	7.66	7.97	7.90	7.95	
2	8.10		7.99	8.45	8.55	7.97	8.45	8.37	8.24	7.87	7.48	8.11	
3	7.96		7.99	8.56	8.35	8.32	8.36	7.93	8.37	7.92	7.50		
4	8.11	8.32	8.27	8.61	8.11	8.41	7.65	7.93	8.40	7.91		8.16	
5	6.44	8.27	8.38			8.38	7.94	8.27	8.45	7.75	8.30		
6		8.44	8.50	8.03		8.43	7.75	8.29		7.57	8.26	7.90	
7		8.31		8.12		8.38	7.77	8.14	8.18	8.18	8.31		
8	8.19				8.44	8.04	8.29	8.70	7.94	8.16	8.19	8.09	
9	8.07			8.05	8.48	7.88	8.34	8.24	8.17		7.56	8.20	
10			8.32	8.51	8.27	8.15		7.71	8.24		6.31	8.12	
11	8.06	8.32	8.46	8.12	7.88	7.89		7.92	8.26	8.08	8.38	8.14	
12	7.77	8.38	8.55	8.08	7.85	8.38	8.36	8.28	8.21	7.71	7.93	7.98	
13	7.58	8.38	8.57	7.97	8.44	7.55	8.02	8.24	8.15	7.77	8.21	6.54	
14	7.85	8.05	8.55		8.59	8.11	8.02	8.28	7.87	8.11	8.51	7.42	
15	8.36	8.23	8.43		8.47	7.80	8.14	8.27	7.94	8.10		7.09	
16	8.35	7.71	7.98	8.43	8.41	7.69	7.82	8.30	7.95	8.08	7.76	7.79	
17	8.25	7.68	7.93	8.57	8.31	8.25	8.40	7.83	8.19	7.32	7.43	8.20	
18	8.08	8.03	8.38	8.45	7.94	8.17	8.19	8.03	8.24	7.86	8.07	8.13	
19	7.85		8.35	8.13	8.14	8.32	8.35	8.19	8.25	6.70	8.00		
20	7.43		8.50	8.02	8.33	8.34	7.90	8.27	8.16	7.86		8.03	
21	8.25		7.75	7.87	8.35	8.27		8.36	7.80	7.78		7.99	
22	8.32	8.37	8.36	8.27	8.45	7.78	8.20	8.38	7.64	8.06		7.89	
23	8.28	8.31	7.75	8.27	8.00	7.65	8.50	8.31	8.01	8.06	7.89	8.11	
24		8.11	7.54	8.15	8.35	8.14	8.54	7.86	7.99	8.01	7.65	7.97	
25		8.27	7.74		7.98	8.27		8.00	7.98	7.90	8.08	6.70	
26		7.95	8.46	8.27	6.94	8.05			8.02	7.58	8.07	7.83	
27		8.42	8.39	7.76	8.03	7.89	7.97	8.34	7.91	7.65	8.21	7.90	
28	8.30	8.17	8.21	7.87	8.31	8.39	8.00	8.39	7.62			7.71	
29	8.28		8.29	8.30	8.54	8.23	8.36	8.39	7.40		7.39	7.58	
30	8.36		7.48	8.38	7.85	7.85	7.87	8.50	7.98	8.17	7.79	7.97	
31	7.84		7.77		8.30		8.31	8.05		8.02		7.90	
<b>Average</b>	7.98	8.19	8.18	8.23	8.21	8.10	8.14	8.19	8.04	7.86	7.88	7.83	8.07
<b>Minimum</b>	6.44	7.68	7.48	7.76	6.94	7.55	7.65	7.71	7.40	6.70	6.31	6.54	6.31
<b>Maximum</b>	8.36	8.44	8.57	8.61	8.59	8.43	8.54	8.70	8.45	8.18	8.51	8.20	8.70
<b>Total</b>	191	164	229	206	230	243	212	246	233	212	189	211	2566
													Annual Summary

# South Bay Wastewater Reclamation Plant 2013 Daily Influent Weather Flows

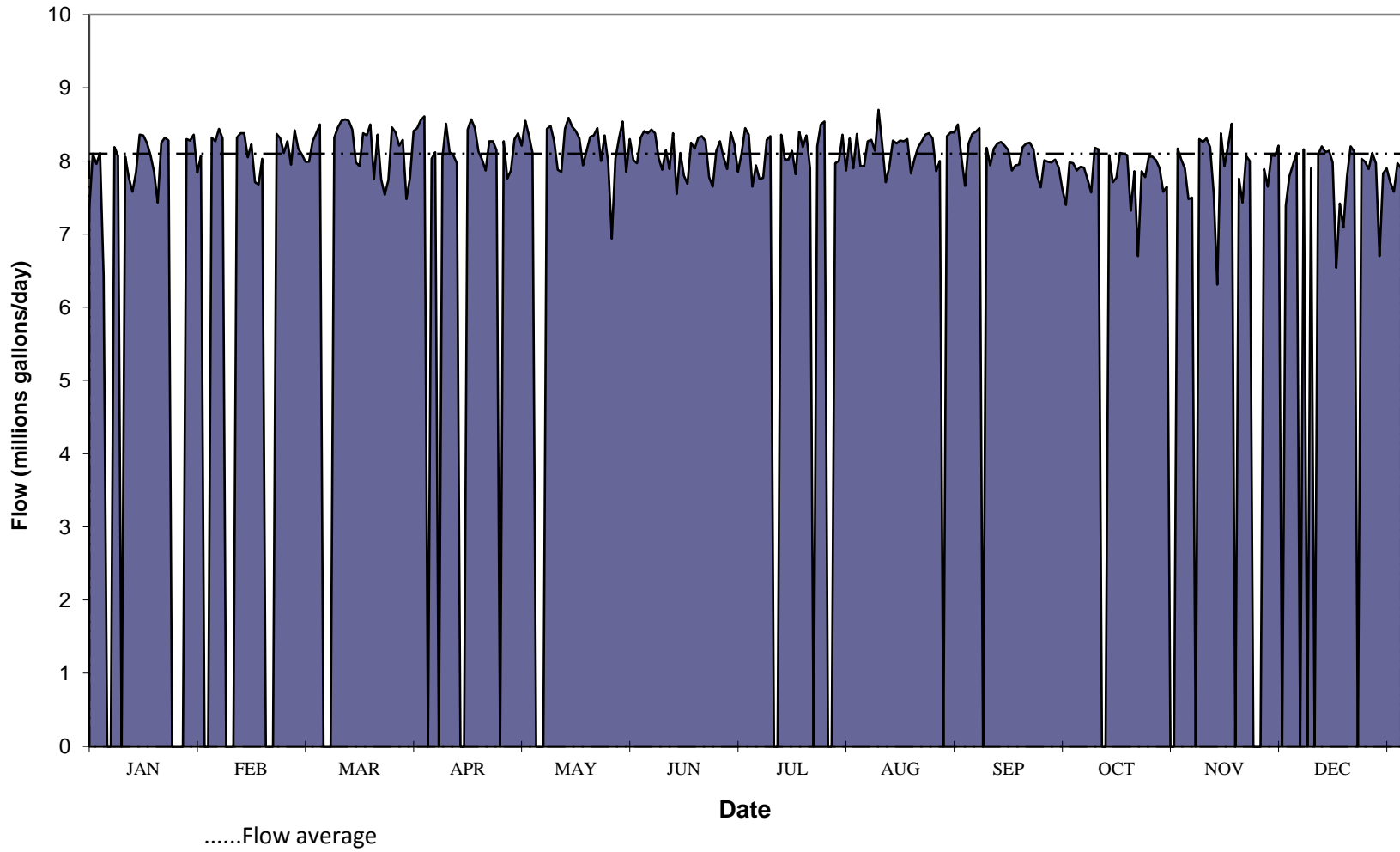

# South Bay Water Reclamation Plant

## Effluent Dry Weather Flows (mgd) 2013

Day	Jan	Feb	Mar	Apr	May	Jun	Jul	Aug	Sep	Oct	Nov	Dec	
1	6.27	6.80	4.13	3.07	2.44	0.82	0.34	0.36	3.49	0.94	6.26	6.13	
2	6.06		6.18	4.13	1.67	1.49	0.45	0.44	1.52	0.41	6.01	6.69	
3	6.44		6.17	3.24	1.64	0.79	0.18	0.29	0.15	0.04	5.70		
4	6.67	6.34	4.70	4.23	3.62	0.79	0.06	1.39	0.24	0.04		4.97	
5	5.97	5.10	2.93			0.64	0.08	2.59	0.15	0.04	1.58		
6		2.87	3.85	5.41		0.75	1.07	1.72		0.92	2.30	4.02	
7		4.93		6.20		0.65	5.65	2.35	0.05	1.18	2.38		
8	6.71				5.65	0.84	0.09	2.05	2.32	0.57	2.41	3.73	
9	6.44			2.53	4.13	6.09	0.35	0.93	2.04		2.35	6.55	
10			6.55	5.43	3.50	1.82		0.54	0.70		4.30	6.57	
11	6.43	6.51	6.64	5.05	4.27	0.54		0.77	0.16	4.63	4.00	6.49	
12	6.55	6.71	5.83	5.23	3.26	0.55	0.06	0.98	0.16	4.25	1.91	5.54	
13	6.12	6.79	6.83	5.63	2.15	1.30	2.13	0.76	0.07	5.68	2.60	5.53	
14	6.46	6.76	7.04		2.47	0.43	5.30	0.52	0.08	3.05	2.10	5.41	
15	5.80	6.15	7.04		4.70	0.47	0.11	0.57	3.15	1.58		5.73	
16	6.45	4.09	6.49	1.87	5.69	2.58	0.34	0.23	2.84	0.84	3.14	3.41	
17	6.39	3.83	6.15	1.61	2.87	2.08	0.05	0.34	0.74	0.70	6.01	3.28	
18	6.48	5.60	3.60	1.61	2.38	0.66	6.65	0.71	0.36	0.89	2.44	3.24	
19	6.37		2.29	2.51	1.47	0.55	3.16	1.72	0.10	0.67	6.58		
20	5.85		5.05	1.50	1.67	0.63	0.96	0.91	0.08	1.76		3.74	
21	5.58		6.15	3.81	1.78	0.42		1.02	0.08	2.43		6.31	
22	6.68	6.87	4.12	1.88	1.24	0.20	0.05	1.14	0.45	1.54		6.36	
23	3.91	6.86	1.79	4.59	0.76	2.21	0.10	1.24	1.42	4.24	6.34	6.58	
24		6.52	5.11	2.03	0.74	1.78	1.53	0.25	0.12	4.52	6.27	6.34	
25		6.63	3.70		0.70	0.58		0.06	0.32	0.64	6.28	6.01	
26		6.86	6.28	4.79	5.03	0.41			0.06	0.08	6.48	5.45	
27	0.00	3.86	4.01	1.50	2.92	1.22	0.13	1.36	0.06	2.24	6.56	4.28	
28	6.41	2.88	2.02	2.24	1.52	0.50	0.36	0.60	0.74			3.33	
29	6.37		3.15	1.52	1.27	0.49	1.43	0.54	2.85		6.06	3.17	
30	6.62		5.87	1.62	1.02	0.42	2.77	0.11	2.05	3.83	6.00	3.28	
31	6.89		3.97		0.83		1.26	0.09		6.35		3.61	Annual Summary
<b>Average</b>	6.00	5.65	4.92	3.33	2.55	1.09	1.33	0.89	0.92	2.00	4.42	5.03	3.05
<b>Minimum</b>	0.00	2.87	1.79	1.50	0.70	0.20	0.05	0.06	0.05	0.04	1.58	3.17	0.00
<b>Maximum</b>	6.89	6.87	7.04	6.20	5.69	6.09	6.65	2.59	3.49	6.35	6.58	6.69	7.04
<b>Total</b>	149.9	113.0	138	83	71.4	32.7	34.7	26.6	26.6	54.1	106.1	135.8	972



# South Bay Wastewater Reclamation Plant 2013 Daily Effluent to Ocean Dry Weather Flows

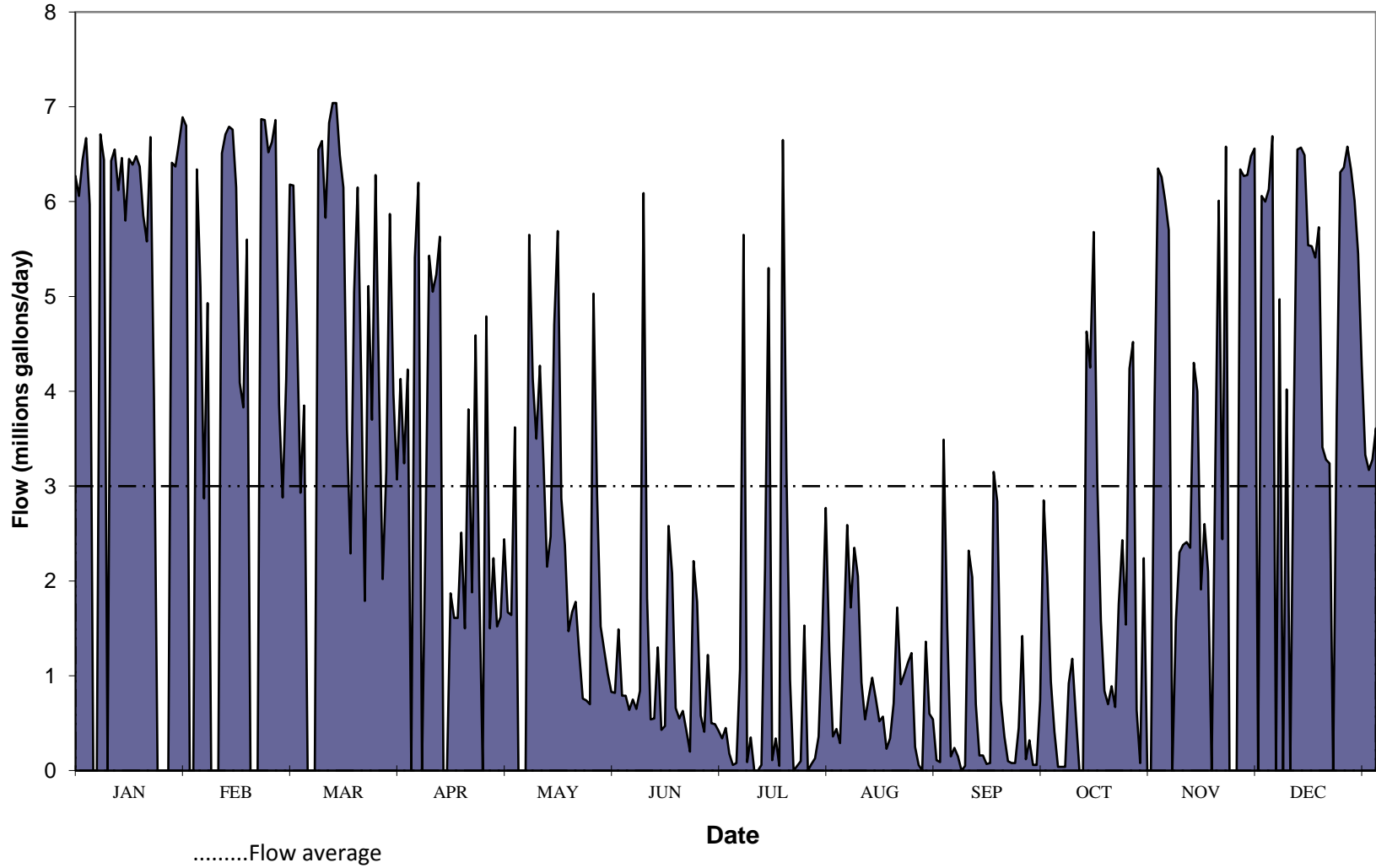

B. Rain Days

**San Diego Precipitation -2013  
Daily Rainfall - Lindbergh Field**

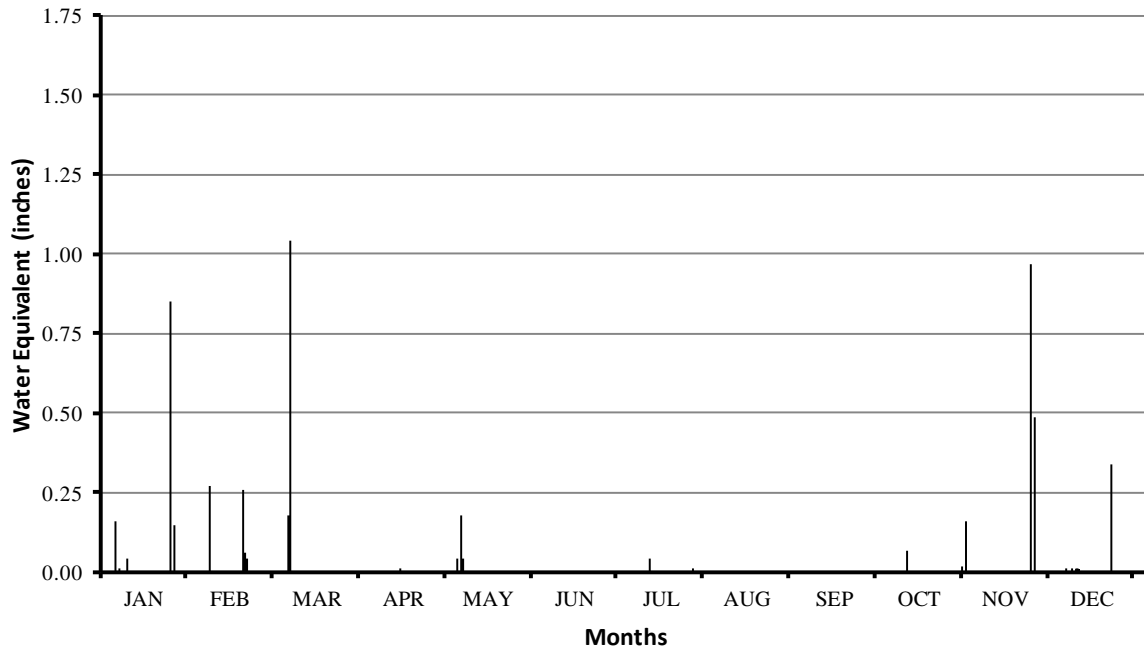

## San Diego Precipitation – 2013 Daily Rainfall – Lindbergh Field

**Total Annual Precipitation=5.46**

**Maximum=1.04**

**Trace=0**

First Quarter		Second Quarter		Third Quarter		Fourth Quarter	
Date	Rain	Date	Rain	Date	Rain	Date	Rain
6-Jan-13	0.16	5-Apr-13	T	10-Jul-13	T	9-Oct-13	0.07
7-Jan-13	0.01	8-Apr-13	T	11-Jul-13	0.04	10-Oct-13	T
10-Jan-13	0.04	14-Apr-13	T	21-Jul-13	T	28-Oct-13	0.02
24-Jan-13	T	15-Apr-13	0.01	25-Jul-13	T	29-Oct-13	0.16
25-Jan-13	0.85	25-Apr-13	T	26-Jul-13	0.01	4-Nov-13	T
26-Jan-13	0.15	5-May-13	0.04	26-Aug-13	T	15-Nov-13	T
27-Jan-13	T	6-May-13	0.18	6-Sep-13	T	20-Nov-13	T
2-Feb-13	T	7-May-13	0.04			21-Nov-13	0.97
3-Feb-13	T					22-Nov-13	0.49
8-Feb-13	0.27					28-Nov-13	T
9-Feb-13	T					3-Dec-13	0.01
10-Feb-13	T					5-Dec-13	0.01
19-Feb-13	0.26					7-Dec-13	0.01
20-Feb-13	0.06					19-Dec-13	0.34
21-Feb-13	0.04						
7-Mar-13	0.18						
8-Mar-13	1.04						
9-Mar-13	T						
<b>TOTALS</b>	<b>3.06</b>		<b>0.27</b>		<b>0.05</b>		<b>2.08</b>

C. Chemical Report

South Bay Water Reclamation Plant - Annual Chemical Usage Report

2013

Date	Hypochlorite Gallons	Alum Chloride Gallons	Polymer Cationic Gallons	Sodium Hydroxide Gallons
Jan-13	10,916	73	675	1,223
Feb-13	12,647	39	660	1,074
Mar-13	18,461	28	244	4,907
Apr-13	14,577	27	97	1,064
May-13	28,304	31	26	2,941
Jun-13	24,727	20	144	1,915
Jul-13	19,417	433	14	1,602
Aug-13	20,388	434	0	2,084
Sep-13	22,430	22	0	1,431
Oct-13	22,315	61	15	1,765
Nov-13	17,268	28	43	1,360
Dec-13	9,585	54	41	828
<b>avg</b>	<b>18,420</b>	<b>104</b>	<b>163</b>	<b>1,850</b>
<b>sum</b>	<b>221,037</b>	<b>1250</b>	<b>1959</b>	<b>22,196</b>

**South Bay Water Reclamation Plant  
2013 Monthly Chemical Usage**

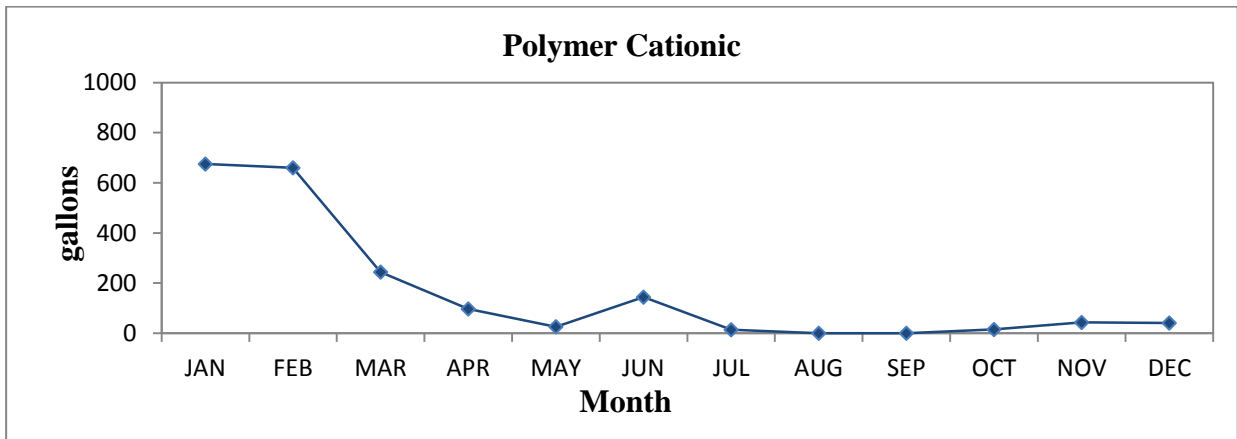
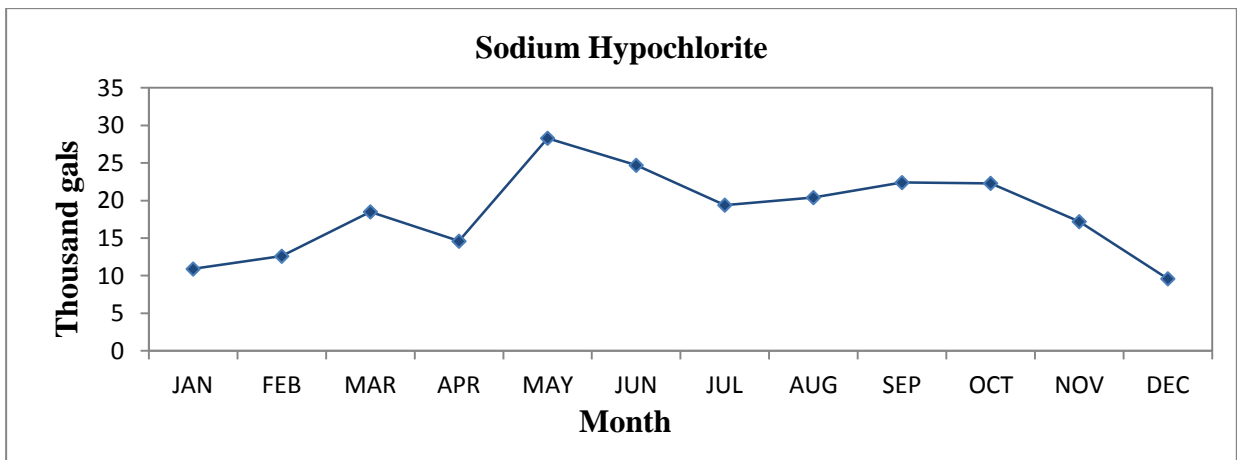
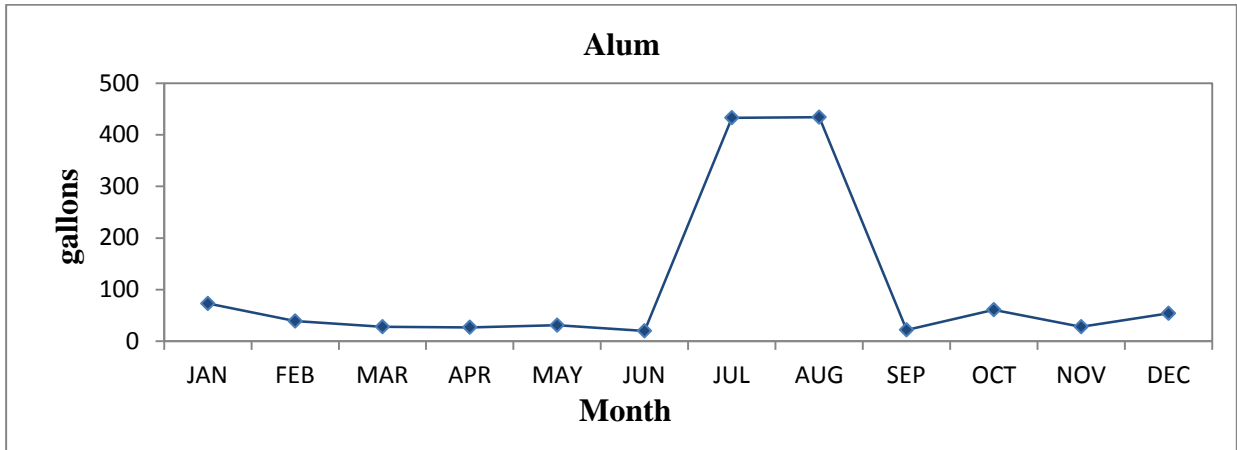

**South Bay Water Reclamation Plant  
2013 Monthly Chemical Usage**

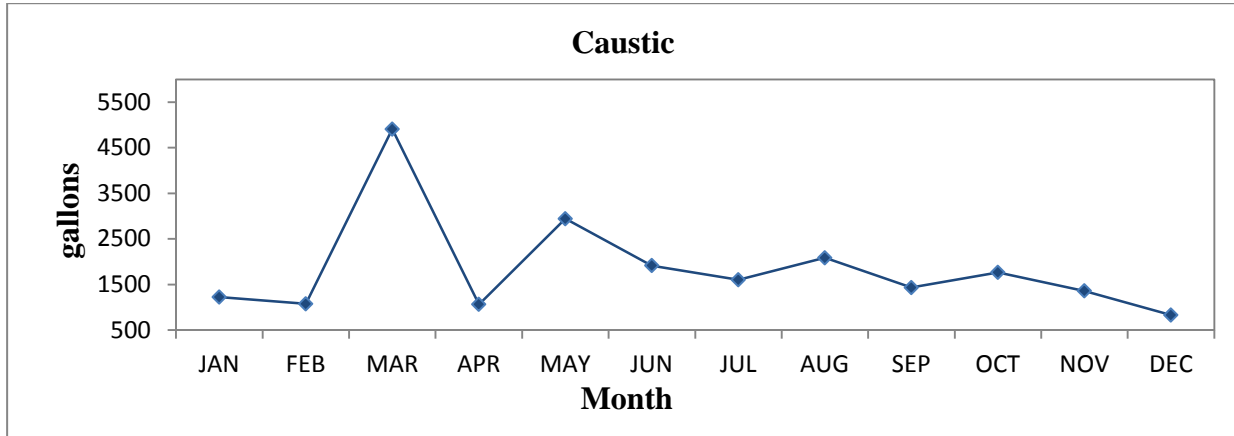

D. Facilities Out of Service Report

**FACILITIES OOS BY DATE**

**Barscreens**

	FROM	TO	REASON
Barscreen 1	4/9/2013	4/9/2013	#1 Barscreen repeatedly fail to park. Please investigate and repair as necessary
Barscreen 2	3/22/2013	3/22/2013	Breaker tripped on screen, Call Out I & C Group.
Barscreen 2	3/25/2013	4/26/2013	#2 Bar Screen tripping just shows Fail alarm on DCS. Please repair as needed.
Barscreen 2	7/22/2013	7/22/2013	#2 Barscreen, tripped, ran manually and making grinding noise needs fixed.
Barscreen 2	12/17/2013	3/18/2014	#2 Barscreen, please lower the local differential level set point to rake at 2.8 PSI which is the DCS set point.

**Primary Sedimentation**

	FROM	TO	REASON
Pri Sed Tank 1	3/5/2013	3/28/2013	#1 Pri Sed Tank, replace solenoid valve for sprayers.
Pri Sed Tank 1	3/5/2013	4/11/2013	#1 Pri Sed Tank, PT to replace solenoid valve for sprayers. Disconnect/reconnect electrical wires as requested by the PT.
Pri Sed Tank 1	9/30/2013	10/1/2013	#1 Pri Sed Tank, draw off valve keeps alarming on TORQ. Electrician checked electrical side to be okay. Need PT to check valve for binding and repair as needed.
Pri Sed Tank 2	5/6/2013	5/9/2013	#2 Pri Sed Tank, drawoff valve for #2 Tank (10-MOV-7041) keeps trying to open when it's not supposed to. Please troubleshoot.
Pri Sed Tank 2	5/13/2013	5/23/2013	#2 Pri Sed Tank, drawoff valve for #2 Tank (10-MOV-7041), this valve still has issues. Just got a fail to close alarm and there is no reason it should have opened in the first place. T. shoot and repair as needed.
Pri Sed Tank 2	10/14/2013	10/15/2013	#2 Pri Sed Tank, Suction Valve 10 MOV 7041 is failing on "Fail to Close" alarm. Please repair.
Pri Sed Tank 3	1/28/2013	2/1/2013	#3 Pri. Sed. Tank, Draw Off Valve (VALVE 10-MOV-7051) fail to open...gen fail...seq fail. Reset and resume. This is happening a lot. Please investigate and repair as needed.
Pri Sed Tank 3	3/5/2013	3/28/2013	#3 Pri Sed Tank, replace solenoid valve for sprayers.
Pri Sed Tank 3	3/5/2013	4/11/2013	#3 Pri Sed Tank, PT to replace solenoid valve for sprayers. Disconnect/reconnect electrical wires as requested by the PT.
Pri Sed Tank 3	3/12/2013	3/14/2013	#3 Pri Sed Tank, draw-off valve (10-MOV-7051) repeatedly fail to open. Please investigate and repair as necessary.

Pri Sed Tank 3	3/25/2013	4/10/2013	#3 Pri Sed Tank, draw-off valve (10-MOV-7051) repeatedly fail to open. Problem is still occurring per Teresa Gardiner's E-Mail on 3/25/13. It causes the strategy to skip pumping the sludge in that tank. Please investigate/ repair problem and test as needed. Please invite Teresa to witness test.
Pri Sed Tank 3	4/17/2013	5/2/2013	#3 Pri Sed Tank, draw off valve (10 MOV 7051) getting GEN FAIL then resets itself each cycle. Trips strategy with fail to close alarm. Please repair.
Pri Sed Tank 4	3/5/2013	3/28/2013	#4 Pri Sed Tank, replace solenoid valve for sprayers.
Pri Sed Tank 4	3/5/2013	6/6/2013	#4 Pri Sed Tank, PT to replace solenoid valve for sprayers. Disconnect/reconnect electrical wires as requested by the PT.
Pri Sed Tank 4	11/18/2013	11/27/2013	#4 Pri Sed Tank, please remove and replace the free spinning sprockets and sleeves.
Pri Sed Tank 5	3/5/2013	3/28/2013	#5 Pri Sed Tank, replace solenoid valve for sprayers.
Pri Sed Tank 5	3/5/2013	8/2/2013	#5 Pri Sed Tank, PT to replace solenoid valve for sprayers. Disconnect/reconnect electrical wires as requested by the PT.
Pri Sed Tank 5	7/15/2013	7/16/2013	#5 Primary Sed. Tank Scum Collector, every time it cycle the strategy fails. Pls. check and repair as needed.
Pri Sed Tank 5	12/30/2013	12/31/2013	#5 Primary Sed Tank, scum lid will not close. Investigate and repair as necessary.

### Aeration Basins

	FROM	TO	REASON
Aer Basin 1	12/12/2013	12/12/2013	Please remove Actuator from FCV valve in Aeration Basin 1 and install in Aeration Basin 3. Then install actuator from 3 into Basin 1's valve to complete loop.
Aer Basin 2	6/24/2013	6/26/2013	Aeration Basin #2, Zone 2, reading low DO. Repeatedly clean still no change. Please investigate and repair as necessary.
Aer Basin 2	12/10/2013	12/10/2013	#2 Aeration Basin, Air Flow Control Valve (15-FCV-320) keeps going into Gen Fail. Clears itself. Check and repair as needed.
Aer Basin 2	12/11/2013	12/11/2013	#2 Aeration Basin Air Flow Control Valve (15-FCV-320), checked valve actuator and operated with Ops permission, both locally and remotely with satisfactory results. Noticed a lot of grease coming out of the reduction gearbox. Cleaned grease and inspected the area. Air is also coming out of the gearbox together with the grease. Showed the status of the Flow Control Valve to Ops Supervisor, Teresa Gardiner. Need PT to check out and repair this problem as necessary.



Aer Basin 3	4/11/2013	4/11/2013	#3 Aeration Basin, Zone 4 DO is low. Please investigate and repair as necessary.
Aer Basin 3	8/15/2013	12/12/2013	#3 Aeration Basin, air valve 15 FCV 330 is tripping on Gen Fail, please repair. Remove actuator from valve and install actuator from Basin #1. Use this actuator in 'Basin #1 to complete loop. See Doyle
Aer Basin 3	12/12/2013	12/12/2013	#3 Aeration Basin, air valve 15 FCV 330 is tripping on Gen Fail, please repair. Remove actuator from valve and install actuator from Basin #1. Use this actuator in 'Basin #1 to complete loop. See Doyle
Aer Basin 4	7/15/2013	7/16/2013	#4 Aeration Basin, install DO probes so we can put tank in service.
Aer Basin 5	4/11/2013	4/11/2013	#5 Aeration Basin, Zone 2 DO is low. Please investigate and repair as necessary.
Aer Basin 5	11/7/2013	11/8/2013	#5 Aeration Basin, Zone #2, D/O probe reading very high. Check and repair as needed.
Aer Basin 6	8/15/2013	8/15/2013	#6 Aeration Basin Tank, air valve going to Gen-Fail, please inspect/repair.

### Secondary Clarifiers

	FROM	TO	REASON
Sec Clar 1	11/25/2013	12/6/2013	#1 Sec Scum Collector, position indicator moving around and trips scum sequence. Please adjust.
Sec Clar 1	12/3/2013	12/3/2013	#1 Sec Clarifier Scum Collector Actuator, replace new saddle gear, worm gear and fabricate stainless steel shaft.
Sec Clar 2	6/6/2013	10/7/2013	#2 Sec Clarifier Sludge Drive, when performing quarterly PM, found discrepancy on slip drive unit. Drive unit did not slip, test was unsatisfactory. Repair as needed.
Sec Clar 3	7/9/2013	7/10/2013	#3 Sec Clarifier Scum Collector, high torque on scum trough. It won't go to center position. Please investigate and repair as needed.
Sec Clar 3	6/12/2013	6/12/2013	SECONDARY TANK #3 - Collector Shear Pin Fail. We are currently placing this tank into service. Please advise operator as soon as possible if we should stop filling and take this tank OOS.
Sec Clar 4	3/5/2013	4/26/2013	#4 Sec Clarifier Sludge Drive, shear pin hub does not rotate freely from drive sprocket when pin is removed. Repair as needed.
Sec Clar 5	10/31/2013	11/4/2013	#5 Sec Clarifier Sludge Drive, chain is popping. Please investigate and repair as necessary. Problem is with drive chain, see Vic Diaz for details.
Sec Clar 5	5/21/2013	5/21/2013	#5 Secondary Scum Collector, does not rotate far enough in the reverse position. Please adjust.
Sec Clar 5	7/25/2013	10/14/2013	#5 Sec Clarifier Scum Collector Actuator, ring gear reportedly needs replaced.

Sec Clar 5	9/9/2013	10/3/2013	Need new S/S drive shaft and new ring gear on saddle.
Sec Clar 5	10/31/2013	11/6/2013	#5 Sec Clarifier Scum Collector (trough) is not rotating. Investigate and repair as necessary.
Sec Clar 6	8/27/2013	12/2/2013	#6 Sec Clarifier Scum Collector, trough is rotating. Please investigate and repair as necessary.
Sec Clar 6	9/9/2013	10/7/2013	Need new S/S drive shaft and new ring gear on saddle.
Sec Clar 6	10/1/2013	10/4/2013	Prep prime and paint new ring gear on saddle.
Sec Clar 7	11/19/2013	11/21/2013	#7 Sec Clarifier Scum Collector, actuator repeatedly fails up. Trough is in the wrong position. Please investigate and repair as necessary.
Sec Clar 8	7/15/2013	7/18/2013	#8 Sec Clarifier Scum Collector Actuator, failed, no power, failed forward, sticking and hard to move manually. Please assist Electrician in troubleshooting / repair as needed.
Sec Clar 9	11/12/2013	11/22/2013	#9 Sec Clarifier, scum actuator moving on its own in local. Check and repair as needed.
Sec Clar 10	11/25/2013	12/6/2013	#1 Sec Scum Collector, position indicator moving around and trips scum sequence. Please adjust.
Sec Clar 10	12/3/2013	12/3/2013	#1 Sec Clarifier Scum Collector Actuator, replace new saddle gear, worm gear and fabricate stainless steel shaft.

### Tertiary Filters

	FROM	TO	REASON
Ter Filter 1	1/17/2013	1/17/2013	#1 Influent Valve (25-MOV-212) on Filter #1 leaks by at the seat. Investigate and repair as necessary. Thank You.
Ter Filter 1	6/3/2013	6/4/2013	#1 Tertiary Filter, differential pressure is staying high. It is causing the filter to backwash much too frequently. Please confirm if it is a true value/ repair as needed.
Ter Filter 4	6/4/2013	10/8/2013	Solitax probe for turbidity needs to be installed and placed in sedimentary associated with Filter #4. See Kip for details.
Ter Filter 4	6/4/2013	6/19/2013	Need to fabricate flexi-glass board to mount sedimentary to in the RAS gallery to Filter #4. See Kip for details.
Ter Filter 5	10/31/2013	10/31/2013	#5 Tertiary Filter, Gen Fail alarms on FLI valve (25 MOV 252) and waste valve (25 MOV 255). Ops tried to reset, no luck. Check and repair as needed.
Ter Filter 5	11/23/2013	11/23/2013	Lost power to FLI valve, drain valve and waste valve. Call out.
Ter Filter 5	11/25/2013	11/27/2013	#5 Tertiary Filter Tank, lost power to FLI valve, drain valve and waste valve. Continue t. shooting / repair.
Ter Filter 7	10/31/2013	10/31/2013	#7 Tertiary Filter, Gen Fail on Waste valve (25 MOV 275), Ops tried reset, no luck. Check and repair as needed.

Ter Filter 7	11/23/2013	11/23/2013	Lost power to FLI valve, drain valve and waste valve. Call out.
Ter Filter 7	11/25/2013	11/27/2013	#7 Tertiary Filter Tank, lost power to FLI valve, drain valve and waste valve. Continue troubleshooting / repair.

## FACILITIES OOS BY PROCESS

### Bar Screens

	FROM	TO
Barscreen 1	4/9/2013	4/9/2013
Barscreen 2	3/22/2013	3/22/2013
	3/25/2013	4/26/2013
	7/22/2013	7/22/2013
	12/17/2013	3/18/2014

### Primary Sedimentation

	FROM	TO
Pri Sed Tank 1	3/5/2013	3/28/2013
	3/5/2013	4/11/2013
	9/30/2013	10/1/2013
Pri Sed Tank 2	5/6/2013	5/9/2013
	5/13/2013	5/23/2013
	10/14/2013	10/15/2013
Pri Sed Tank 3	1/28/2013	2/1/2013
	3/5/2013	3/28/2013
	3/5/2013	4/11/2013
	3/12/2013	3/14/2013
	3/25/2013	4/10/2013
	4/17/2013	5/2/2013
Pri Sed Tank 4	3/5/2013	3/28/2013
	3/5/2013	6/6/2013
	11/18/2013	11/27/2013
Pri Sed Tank 5	3/5/2013	3/28/2013
	3/5/2013	8/2/2013
	7/15/2013	7/16/2013
	12/30/2013	12/31/2013

### Aeration Basins

	FROM	TO
Aer Basin 1	12/12/2013	12/12/2013
Aer Basin 2	6/24/2013	6/26/2013
	12/10/2013	12/10/2013
	12/11/2013	12/11/2013

Aer Basin 3	4/11/2013	4/11/2013
	8/15/2013	12/12/2013
	12/12/2013	12/12/2013
Aer Basin 4	7/15/2013	7/16/2013
Aer Basin 5	4/11/2013	4/11/2013
	11/7/2013	11/8/2013
Aer Basin 6	8/15/2013	8/15/2013

### Secondary Clarifiers

	FROM	TO
Sec Clar 1	11/25/2013	12/6/2013
	12/3/2013	12/3/2013
Sec Clar 2	6/6/2013	10/7/2013
Sec Clar 3	7/9/2013	7/10/2013
	6/12/2013	6/12/2013
Sec Clar 4	3/5/2013	4/26/2013
Sec Clar 5	10/31/2013	11/4/2013
	5/21/2013	5/21/2013
	7/25/2013	10/14/2013
	9/9/2013	10/3/2013
	10/31/2013	11/6/2013
Sec Clar 6	8/27/2013	12/2/2013
	9/9/2013	10/7/2013
	10/1/2013	10/4/2013
Sec Clar 7	11/19/2013	11/21/2013
Sec Clar 8	7/15/2013	7/18/2013
Sec Clar 9	11/12/2013	11/22/2013
Sec Clar 10	11/25/2013	12/6/2013
	12/3/2013	12/3/2013

### Tertiary Filter

	FROM	TO
Ter Filter 1	1/17/2013	1/17/2013
	6/3/2013	6/4/2013
Ter Filter 4	6/4/2013	10/8/2013
	6/4/2013	6/19/2013
Ter Filter 5	10/31/2013	10/31/2013
	11/23/2013	11/23/2013
	11/25/2013	11/27/2013
Ter Filter 7	10/31/2013	10/31/2013
	11/23/2013	11/23/2013
	11/25/2013	11/27/2013

#### IV. Combined Ocean Outfall Data

##### Data Summaries

This section presents the results of analyses of the combined or mixed effluent stream being discharged to the South Bay Ocean Outfall from the South Bay Wastewater Reclamation and International Wastewater Treatment Plant for 2013.

SB\_ITP\_COMB\_EFF designates a composite sample taken at a point downstream of the discharges of both plants where the wastewater stream is a mixture of both effluents (the secondary or tertiary effluent from SBWRP and the primary effluent from the IWTP).

Sampling and monitoring analyses occurred quarterly in February, May, August and October.

Discharge limits do not apply to this combined flow; but quarterly monitoring is required.

---

This page left blank intentionally

SOUTH BAY WATER RECLAMATION PLANT  
ANNUAL SEWAGE: COMBINED OUTFALL (SB\_ITP\_COMB\_EFF)

Annual 2013

Source: SB\_ITP\_COMB\_EFF

Date:		05-FEB-2013	09-MAY-2013	06-AUG-2013	25-AUG-2013	01-OCT-2013
Sample ID:	MDL Units	P649733	P661201	P671208	P674614	P677748
Aluminum	47 UG/L	118	171	106		ND
Antimony	2.9 UG/L	ND	3	ND		7
Arsenic	.4 UG/L	1.2	1.0	1.8		2.5
Barium	.039 UG/L	22.7	28.9	24.2		21.2
Beryllium	.022 UG/L	ND	ND	ND		0.03
Boron	7 UG/L	300	531	456		463
Cadmium	.53 UG/L	ND	ND	ND		ND
Chromium	1.2 UG/L	1.3	1.7	ND		2.6
Cobalt	.85 UG/L	1.0	ND	ND		ND
Copper	2 UG/L	11	7	7		4
Iron	37 UG/L	302	258	181		192
Lead	2 UG/L	3	ND	ND		ND
Manganese	.24 UG/L	52.7	144	57.3		36
Mercury	.005 UG/L	ND	ND	0.015		ND
Molybdenum	.89 UG/L	6.6	9.8	8.3		7.2
Nickel	.53 UG/L	11.6	22.1	12.3		31.5
Selenium	.28 UG/L	1.27	1.59	1.16		1.76
Silver	.4 UG/L	ND	ND	ND		ND
Thallium	3.9 UG/L	ND	ND	ND		ND
Vanadium	.64 UG/L	1.2	0.8	1.1		2.1
Zinc	2.5 UG/L	43.1	48.0	21.2		25.7
Calcium Hardness	.1 MG/L	241	290	211		201
Magnesium Hardness	.4 MG/L	171	150	154		152
Total Hardness	.4 MG/L	411	330	365		353
Total Alkalinity (bicarbonate)	20 MG/L	188	162	177		147
Calcium	.04 MG/L	96	95	85		81
Lithium	.002 MG/L	0.06	0.06	0.07		0.07
Magnesium	.1 MG/L	41	41	37		37
Potassium	.3 MG/L	24	27	24		22
Sodium	1 MG/L	281	290	280		273
Bromide	.1 MG/L	0.4	0.4	0.3		0.2
Chloride	7 MG/L	316	355	338		347
Fluoride	.05 MG/L	0.48	0.57	0.59		0.65
Nitrate	.04 MG/L	34.8	53.6	18.8		69.6
Ortho Phosphate	.2 MG/L	11.7	7.6	8.1		13.9
Sulfate	9 MG/L	313	306	339		359
Cyanide, Total	.002 MG/L	0.004	0.006	0.004		0.003
Sulfides-Total	.4 MG/L	ND	ND	ND		ND
BOD (Biochemical Oxygen Demand)	2 MG/L	35	12	9		6
Total Suspended Solids	1.4 MG/L	10.5	5.3	5.1		5.3
Volatile Suspended Solids	1.6 MG/L	8.8	4.7	3.9		4.5
Total Dissolved Solids	28 MG/L	1330	1630	1600		1520
Settleable Solids (Grab)	.1 ML/L	ND	0.3^	ND		ND
pH (Grab)	PH	7.31	7.46^	7.62		7.69
Turbidity	.13 NTU	3.8	2.1	2.5		1.9
Chlorine Residual, Total (Grab)	.03 MG/L	ND	0.05^	0.07		0.26
Ammonia-N	.3 MG/L	1.4	0.6	3.2	2.5	ND
Total Kjeldahl Nitrogen	1.6 MG/L	7.4	2.7		4.4	2.4

^= This is a grab sample collected on May 7, 2013

ND= Not Detected

Chromium results are for Total Chromium.

SOUTH BAY WATER RECLAMATION PLANT  
ANNUAL SEWAGE: COMBINED OUTFALL (SB\_ITP\_COMB\_EFF)  
Temperature

Annual 2013

Analyte:	Temperature
	GRAB
Units:	(°C)
=====	=====
05-FEB-2013	18.6
07-MAY-2013	25.0
06-AUG-2013	27.9
01-OCT-2013	26.3
=====	=====
Average:	24.5
Maximum:	27.9
Minimum:	18.6

ND= Not Detected



SOUTH BAY WATER RECLAMATION PLANT  
ANNUAL SEWAGE: COMBINED EFFLUENT (SB\_ITP\_COMB\_EFF)

Ammonia-Nitrogen and Total Cyanides

Annual 2013

Source:	COMB EFF	COMB EFF
Analyte:	Ammonia-N	Cyanides, Total
MDL/ Units:	.3 MG/L	.002 MG/L
=====	=====	=====
FEBRUARY -2013	1.4	0.004
MAY -2013	0.6	0.006
AUGUST -2013	2.9	0.004
OCTOBER -2013	ND	0.003
=====	=====	=====
Average:	1.2	0.004

ND= not detected

SOUTH BAY WATER RECLAMATION PLANT  
ANNUAL SEWAGE: COMBINED OUTFALL (SB\_ITP\_COMB\_EFF)

Radioactivity

Annual 2013

Source	Month	Gross Alpha Radiation
SB_ITP_COMB_EFF	FEBRUARY -2013	2.8 ± 6.4
SB_ITP_COMB_EFF	MAY -2013	5.6 ± 8.3
SB_ITP_COMB_EFF	AUGUST -2013	1.6 ± 7.9
SB_ITP_COMB_EFF	OCTOBER -2013	-2.1 ± 5.9
AVERAGE		2.0 ± 7.1

Source	Month	Gross Beta Radiation
SB_ITP_COMB_EFF	FEBRUARY -2013	33.1 ± 7.8
SB_ITP_COMB_EFF	MAY -2013	23.9 ± 9.5
SB_ITP_COMB_EFF	AUGUST -2013	19.5 ± 8.9
SB_ITP_COMB_EFF	OCTOBER -2013	31.0 ± 8.1
AVERAGE		26.9 ± 8.6

Units in picocuries/liter (pCi/L)

SOUTH BAY WATER RECLAMATION PLANT  
SEWAGE ANNUAL: COMBINED EFFLUENT

Chlorinated Pesticide Analysis

Annual 2013

Source:	COMB_EFF					COMB_EFF	
Date:	05-FEB-2013	09-MAY-2013	06-AUG-2013	01-OCT-2013			
Analyte	MDL	Units				Avg	
Aldrin	3	NG/L	ND	ND	ND	ND	ND
Dieldrin	8	NG/L	ND	ND	ND	ND	ND
BHC, Alpha isomer	1	NG/L	ND	ND	ND	ND	ND
BHC, Beta isomer	6	NG/L	ND	ND	ND	ND	ND
BHC, Gamma isomer	3	NG/L	ND	ND	ND	ND	ND
BHC, Delta isomer	4	NG/L	ND	ND	ND	ND	ND
p,p-DDD	4	NG/L	ND	ND	ND	ND	ND
p,p-DDE	2	NG/L	ND	ND	ND	ND	ND
p,p-DDT	4	NG/L	ND	ND	ND	ND	ND
o,p-DDD	3	NG/L	ND	ND	ND	ND	ND
o,p-DDE	1	NG/L	ND	ND	ND	ND	ND
o,p-DDT	3	NG/L	ND	ND	ND	ND	ND
Heptachlor	2	NG/L	ND	ND	ND	ND	ND
Heptachlor epoxide	4	NG/L	ND	ND	ND	ND	ND
Alpha (cis) Chlordane	2	NG/L	ND	ND	ND	ND	ND
Gamma (trans) Chlordane	2	NG/L	ND	ND	ND	ND	ND
Alpha Chlordene		NG/L	NA	NA	NA	NA	NA
Gamma Chlordene		NG/L	NA	NA	NA	NA	NA
Oxychlordane	3	NG/L	ND	ND	NA	ND	ND
Trans Nonachlor	3	NG/L	ND	ND	NA	ND	ND
Cis Nonachlor	5	NG/L	ND	ND	NA	ND	ND
Alpha Endosulfan	3	NG/L	ND	ND	ND	ND	ND
Beta Endosulfan	5	NG/L	ND	ND	ND	ND	ND
Endosulfan Sulfate	5	NG/L	ND	ND	ND	ND	ND
Endrin	8	NG/L	ND	ND	ND	ND	ND
Endrin aldehyde	9	NG/L	ND	ND	ND	ND	ND
Mirex	1	NG/L	ND	ND	ND	ND	ND
Methoxychlor	1	NG/L	ND	ND	ND	ND	ND
Toxaphene	330	NG/L	ND	ND	ND	ND	ND
PCB 1016	12	NG/L	ND	ND	ND	ND	ND
PCB 1221	18	NG/L	ND	ND	ND	ND	ND
PCB 1232	12	NG/L	ND	ND	ND	ND	ND
PCB 1242	5	NG/L	ND	ND	ND	ND	ND
PCB 1248	5	NG/L	ND	ND	ND	ND	ND
PCB 1254	11	NG/L	ND	ND	ND	ND	ND
PCB 1260	9	NG/L	ND	ND	ND	ND	ND
PCB 1262	10	NG/L	ND	ND	ND	ND	ND
Aldrin + Dieldrin	8	NG/L	0	0	0	0	0
Hexachlorocyclohexanes	6	NG/L	0	0	0	0	0
DDT and derivatives	4	NG/L	0	0	0	0	0
Chlordane + related cmpds.	5	NG/L	0	0	0	0	0
Polychlorinated biphenyls	18	NG/L	0	0	0	0	0
Endosulfans	5	NG/L	0	0	0	0	0
Heptachlors	4	NG/L	0	0	0	0	0
Chlorinated Hydrocarbons	330	NG/L	0	0	0	0	0

ND=not detected  
NA=not analyzed

Standards for alpha and gamma chlordene are no longer available in the U.S. for the analysis of these compounds.

SOUTH BAY WATER RECLAMATION PLANT  
SEWAGE ANNUAL: COMBINED EFFLUENT

Acid Extractables

Annual 2013

Source: SB\_ITP\_COMB\_EFF

Date:

Analyte	MDL	Units	FEB	MAY	AUG	OCT	Avg
2-Chlorophenol	1.32	UG/L	ND	ND	ND	ND	ND
2,4-Dichlorophenol	1.01	UG/L	ND	ND	ND	ND	ND
4-Chloro-3-methylphenol	1.67	UG/L	ND	ND	ND	ND	ND
2,4,6-Trichlorophenol	1.65	UG/L	ND	ND	ND	ND	ND
Pentachlorophenol	1.12	UG/L	ND	ND	ND	ND	ND
Phenol	1.76	UG/L	ND	ND	ND	ND	ND
2-Nitrophenol	1.55	UG/L	ND	ND	ND	ND	ND
2,4-Dimethylphenol	2.01	UG/L	ND	ND	ND	ND	ND
2,4-Dinitrophenol	2.16	UG/L	ND	ND	ND	ND	ND
4-Nitrophenol	1.14	UG/L	ND	ND	ND	ND	ND
2-Methyl-4,6-dinitrophenol	1.52	UG/L	ND	ND	ND	ND	ND
Total Chlorinated Phenols	1.67	UG/L	0.0	0.0	0.0	0.0	0.0
Total Non-Chlorinated Phenols	2.16	UG/L	0.0	0.0	0.0	0.0	0.0
Total Phenols	2.16	UG/L	0.0	0.0	0.0	0.0	0.0

Additional analytes determined

2-Methylphenol	2.15	UG/L	ND	ND	ND	ND	ND
3-Methylphenol(4-MP is unresolved)		UG/L	NA	NA	NA	NA	NA
4-Methylphenol(3-MP is unresolved)	2.11	UG/L	ND	ND	ND	ND	ND
2,4,5-Trichlorophenol	1.66	UG/L	ND	ND	ND	ND	ND

ND=not detected

NA=not analyzed

SOUTH BAY WATER RECLAMATION PLANT  
SEWAGE ANNUAL Priority Pollutants Base/Neutrals  
COMBINED EFFLUENT

Annual 2013

Source: SB\_ITP\_COMB\_EFF

Date:

Analyte	MDL	Units	FEB	MAY	AUG	OCT	Avg
Acenaphthene	1.8	UG/L	ND	ND	ND	ND	ND
Acenaphthylene	1.77	UG/L	ND	ND	ND	ND	ND
Anthracene	1.29	UG/L	ND	ND	ND	ND	ND
Benzidine	1.52	UG/L	ND	ND	ND	ND	ND
Benzo[a]anthracene	1.1	UG/L	ND	ND	ND	ND	ND
3,4-Benzo(b)fluoranthene	1.35	UG/L	ND	ND	ND	ND	ND
Benzo[k]fluoranthene	1.49	UG/L	ND	ND	ND	ND	ND
Benzo[a]pyrene	1.25	UG/L	ND	ND	ND	ND	ND
Benzo[g,h,i]perylene	1.09	UG/L	ND	ND	ND	ND	ND
4-Bromophenyl phenyl ether	1.4	UG/L	ND	ND	ND	ND	ND
Bis-(2-chloroethoxy) methane	1.01	UG/L	ND	ND	ND	ND	ND
Bis-(2-chloroethyl) ether	1.38	UG/L	ND	ND	ND	ND	ND
Bis-(2-chloroisopropyl) ether	1.16	UG/L	ND	ND	ND	ND	ND
4-Chlorophenyl phenyl ether	1.57	UG/L	ND	ND	ND	ND	ND
2-Chloronaphthalene	1.87	UG/L	ND	ND	ND	ND	ND
Chrysene	1.16	UG/L	ND	ND	ND	ND	ND
Dibenzo(a,h)anthracene	1.01	UG/L	ND	ND	ND	ND	ND
Butyl benzyl phthalate	2.84	UG/L	ND	ND	ND	ND	ND
Di-n-butyl phthalate	3.96	UG/L	ND	ND	ND	ND	ND
Bis-(2-ethylhexyl) phthalate	8.96	UG/L	ND	ND	ND	ND	ND
Diethyl phthalate	3.05	UG/L	ND	ND	ND	ND	ND
Dimethyl phthalate	1.44	UG/L	ND	ND	ND	ND	ND
Di-n-octyl phthalate	1	UG/L	ND	ND	ND	ND	ND
3,3-Dichlorobenzidine	2.44	UG/L	ND	ND	ND	ND	ND
2,4-Dinitrotoluene	1.36	UG/L	ND	ND	ND	ND	ND
2,6-Dinitrotoluene	1.53	UG/L	ND	ND	ND	ND	ND
1,2-Diphenylhydrazine	1.37	UG/L	ND	ND	ND	ND	ND
Fluoranthene	1.33	UG/L	ND	ND	ND	ND	ND
Fluorene	1.61	UG/L	ND	ND	ND	ND	ND
Hexachlorobenzene	1.48	UG/L	ND	ND	ND	ND	ND
Hexachlorobutadiene	1.64	UG/L	ND	ND	ND	ND	ND
Hexachlorocyclopentadiene	1.25	UG/L	ND	ND	ND	ND	ND
Hexachloroethane	1.32	UG/L	ND	ND	ND	ND	ND
Indeno(1,2,3-CD)pyrene	1.14	UG/L	ND	ND	ND	ND	ND
Isophorone	1.53	UG/L	ND	ND	ND	ND	ND
Naphthalene	1.65	UG/L	ND	ND	ND	ND	ND
Nitrobenzene	1.6	UG/L	ND	ND	ND	ND	ND
N-nitrosodimethylamine	1.27	UG/L	ND	ND	ND	ND	ND
N-nitrosodi-n-propylamine	1.16	UG/L	ND	ND	ND	ND	ND
N-nitrosodiphenylamine	3.48	UG/L	ND	ND	ND	ND	ND
Phenanthrene	1.34	UG/L	ND	ND	ND	ND	ND
Pyrene	1.43	UG/L	ND	ND	ND	ND	ND
1,2,4-Trichlorobenzene	1.52	UG/L	ND	ND	ND	ND	ND
Polynuc. Aromatic Hydrocarbons	1.77	UG/L	0.0	0.0	0.0	0.0	0.0
Base/Neutral Compounds	8.96	UG/L	0.0	0.0	0.0	0.0	0.0

Additional analytes determined

Benzo[e]pyrene	1.44	UG/L	ND	ND	ND	ND	ND
Biphenyl	2.29	UG/L	ND	ND	ND	ND	ND
2,6-Dimethylnaphthalene	2.16	UG/L	ND	ND	ND	ND	ND
1-Methylnaphthalene	2.18	UG/L	ND	ND	ND	ND	ND
1-Methylphenanthrene	1.46	UG/L	ND	ND	ND	ND	ND
2-Methylnaphthalene	2.14	UG/L	ND	ND	ND	ND	ND
2,3,5-Trimethylnaphthalene	2.18	UG/L	ND	ND	ND	ND	ND
Perylene	1.41	UG/L	ND	ND	ND	ND	ND

ND=not detected

SOUTH BAY WATER RECLAMATION PLANT  
ANNUAL SEWAGE: COMBINED EFFLUENT

Tributyl Tin Analysis

Annual 2013

Source: SB\_ITP\_COMB\_EFF

DATE:			FEB	MAY	AUG	OCT	
Analyte	MDL	Units					Avg
=====	===	=====	=====	=====	=====	=====	=====
Dibutyltin	7	UG/L	ND	ND	ND	ND	ND
Monobutyltin	16	UG/L	ND	ND	ND	ND	ND
Tributyltin	2	UG/L	ND	ND	ND	ND	ND

ND=not detected

SOUTH BAY WATER RECLAMATION PLANT  
SEWAGE ANNUAL: COMBINED EFFLUENT  
Priority Pollutants Purgeables

Annual 2013

Source: SB\_ITP\_COMB\_EFF

Date:			FEB	MAY	AUG	OCT	
Analyte	MDL	Units					Avg
Dichlorodifluoromethane	.66	UG/L	ND	ND	ND	ND	ND
Chloromethane	.5	UG/L	ND	ND	ND	ND	ND
Vinyl chloride	.4	UG/L	ND	ND	ND	ND	ND
Bromomethane	.7	UG/L	ND	ND	ND	ND	ND
Chloroethane	.9	UG/L	ND	ND	ND	ND	ND
Trichlorofluoromethane	.3	UG/L	ND	ND	ND	ND	ND
Acrolein	1.3	UG/L	ND	ND	ND	ND	ND
1,1-Dichloroethane	.4	UG/L	ND	ND	ND	ND	ND
Methylene chloride	.3	UG/L	ND	ND	ND	ND	ND
trans-1,2-dichloroethene	.6	UG/L	ND	ND	ND	ND	ND
1,1-Dichloroethene	.4	UG/L	ND	ND	ND	ND	ND
Acrylonitrile	.7	UG/L	ND	ND	ND	ND	ND
Chloroform	.2	UG/L	3.4	2.0	ND	1.5	1.7
1,1,1-Trichloroethane	.4	UG/L	ND	ND	ND	ND	ND
Carbon tetrachloride	.4	UG/L	ND	ND	ND	ND	ND
Benzene	.4	UG/L	ND	ND	ND	ND	ND
1,2-Dichloroethane	.5	UG/L	ND	ND	ND	ND	ND
Trichloroethene	.7	UG/L	ND	ND	ND	ND	ND
1,2-Dichloropropane	.3	UG/L	ND	ND	ND	ND	ND
Bromodichloromethane	.5	UG/L	1.6	1.4	ND	ND	0.8
2-Chloroethylvinyl ether	1.1	UG/L	ND	ND	ND	ND	ND
cis-1,3-dichloropropene	.3	UG/L	ND	ND	ND	ND	ND
Toluene	.4	UG/L	ND	1.5	ND	ND	0.4
trans-1,3-dichloropropene	.5	UG/L	ND	ND	ND	ND	ND
1,1,2-Trichloroethane	.5	UG/L	ND	ND	ND	ND	ND
Tetrachloroethene	1.1	UG/L	ND	ND	ND	ND	ND
Dibromochloromethane	.6	UG/L	DNQ	0.9	1.0	ND	0.5
Chlorobenzene	.4	UG/L	ND	ND	ND	ND	ND
Ethylbenzene	.3	UG/L	ND	ND	ND	ND	ND
Bromoform	.5	UG/L	ND	ND	ND	ND	ND
1,1,2,2-Tetrachloroethane	.5	UG/L	ND	ND	ND	ND	ND
1,3-Dichlorobenzene	.5	UG/L	ND	ND	ND	ND	ND
1,4-Dichlorobenzene	.4	UG/L	1.2*	1.4	DNQ	1.0	1.2
1,2-Dichlorobenzene	.4	UG/L	ND	ND	ND	ND	ND
1,2,4-Trichlorobenzene	1.52	UG/L	ND	ND	ND	ND	ND
Halomethane Purgeable Cmpnds	.7	UG/L	0.0	0.0	0.0	0.0	0.0
Dichlorobenzenes	.5	UG/L	0.0	0.0	0.0	0.0	0.0
Total Chloromethanes	.5	UG/L	3.4	2.0	0.0	1.5	1.7
Purgeable Compounds	1.3	UG/L	5.0	7.3	0.0	1.5	4.2

Additional analytes determined

Methyl Iodide	.6	UG/L	ND	ND	ND	ND	ND
Carbon disulfide	.6	UG/L	ND	ND	ND	ND	ND
Acetone	4.5	UG/L	ND	ND	ND	ND	ND
Allyl chloride	.6	UG/L	ND	ND	ND	ND	ND
Methyl tert-butyl ether	.4	UG/L	ND	ND	ND	ND	ND
Chloroprene	.4	UG/L	ND	ND	ND	ND	ND
1,2-Dibromoethane	.3	UG/L	ND	ND	ND	ND	ND
2-Butanone	6.3	UG/L	ND	ND	ND	ND	ND
Methyl methacrylate	.8	UG/L	ND	ND	ND	ND	ND
2-Nitropropane	12	UG/L	ND	ND	ND	ND	ND
4-Methyl-2-pentanone	1.3	UG/L	ND	ND	ND	ND	ND
meta,para xylenes	.6	UG/L	ND	ND	ND	ND	ND
ortho-xylene	.4	UG/L	ND	ND	ND	ND	ND
Isopropylbenzene	.3	UG/L	ND	ND	ND	ND	ND
Styrene	.3	UG/L	ND	ND	ND	ND	ND
Benzyl chloride	1.1	UG/L	ND	ND	ND	ND	ND

\*= Blank did not meet QC criteria for this analyte due to contamination. Result is not used in computations.  
DNQ= (Detected but not quantified). Estimated analyte concentration below calibration range.  
ND= not detected

SOUTH BAY WATER RECLAMATION PLANT  
Organophosphorus Pesticides

COMBINED OUTFALL

Annual 2013

Source: SB_ITP_COMB_EFF		09-MAY-2013	01-OCT-2013
Date:		P661201	P677748
Analyte:	MDL Units		
Demeton O	.15 UG/L	ND	ND
Demeton S	.08 UG/L	ND	ND
Diazinon	.03 UG/L	DNQ0.05	DNQ0.06
Guthion	.15 UG/L	ND	ND
Malathion	.03 UG/L	ND	ND
Parathion	.03 UG/L	ND	ND
Dichlorvos	.05 UG/L	ND	ND
Disulfoton	.02 UG/L	ND	ND
Dimethoate	.04 UG/L	ND	ND
Stirophos	.03 UG/L	ND	ND
Coumaphos	.15 UG/L	ND	ND
Chlorpyrifos	.03 UG/L	ND	ND
Thiophosphorus Pesticides	.15 UG/L	0.0	0.0
Demeton -O, -S	.15 UG/L	0.0	0.0
Total Organophosphorus Pesticides	.15 UG/L	0.0	0.0

ND=not detected

DNQ=Detected not quantifiable, result value is below calibration range but greater or equal MDL.



SOUTH BAY WATER RECLAMATION PLANT  
Annual Sewage Dioxin and Furan Analysis

COMBINED OUTFALL

Annual 2013

Source:				COMB EFF	COMB EFF	COMB EFF	COMB EFF
Date:				FEB	MAY	AUG	OCT
Analyte:	MDL	Units	Equiv	P649733	P661201	P671208	P677748
=====	=====	=====	=====	=====	=====	=====	=====
2,3,7,8-tetra CDD	.26	PG/L	1.000	ND	ND	ND	ND
1,2,3,7,8-penta CDD	.277	PG/L	0.500	ND	ND	ND	ND
1,2,3,4,7,8_hexa_CDD	.482	PG/L	0.100	ND	ND	ND	ND
1,2,3,6,7,8-hexa CDD	.484	PG/L	0.100	ND	ND	ND	ND
1,2,3,7,8,9-hexa CDD	.479	PG/L	0.100	ND	ND	ND	ND
1,2,3,4,6,7,8-hepta CDD	.53	PG/L	0.010	ND	ND	ND	ND
octa CDD	1.4	PG/L	0.001	DNQ5.78	ND	ND	DNQ5.87
2,3,7,8-tetra CDF	.257	PG/L	0.100	ND	ND	ND	ND
1,2,3,7,8-penta CDF	.335	PG/L	0.050	ND	ND	ND	ND
2,3,4,7,8-penta CDF	.34	PG/L	0.500	ND	ND	ND	ND
1,2,3,4,7,8-hexa CDF	.284	PG/L	0.100	ND	ND	ND	ND
1,2,3,6,7,8-hexa CDF	.281	PG/L	0.100	ND	ND	ND	ND
1,2,3,7,8,9-hexa CDF	.348	PG/L	0.100	ND	ND	ND	ND
2,3,4,6,7,8-hexa CDF	.294	PG/L	0.100	ND	ND	ND	ND
1,2,3,4,6,7,8-hepta CDF	.295	PG/L	0.010	ND	ND	ND	ND
1,2,3,4,7,8,9-hepta CDF	.397	PG/L	0.010	ND	ND	ND	ND
octa CDF	.738	PG/L	0.001	ND	ND	ND	ND

Source:				COMB EFF	COMB EFF	COMB EFF	COMB EFF
Date:				TCCD	TCCD	TCCD	TCCD
Analyte:	MDL	Units	Equiv	FEB	MAY	AUG	OCT
=====	=====	=====	=====	P649733	P661201	P671208	P677748
=====	=====	=====	=====	=====	=====	=====	=====
2,3,7,8-tetra CDD	.26	PG/L	1.000	ND	ND	ND	ND
1,2,3,7,8-penta CDD	.277	PG/L	0.500	ND	ND	ND	ND
1,2,3,4,7,8_hexa_CDD	.482	PG/L	0.100	ND	ND	ND	ND
1,2,3,6,7,8-hexa CDD	.484	PG/L	0.100	ND	ND	ND	ND
1,2,3,7,8,9-hexa CDD	.479	PG/L	0.100	ND	ND	ND	ND
1,2,3,4,6,7,8-hepta CDD	.53	PG/L	0.010	ND	ND	ND	ND
octa CDD	1.4	PG/L	0.001	DNQ0.006	ND	ND	DNQ0.006
2,3,7,8-tetra CDF	.257	PG/L	0.100	ND	ND	ND	ND
1,2,3,7,8-penta CDF	.335	PG/L	0.050	ND	ND	ND	ND
2,3,4,7,8-penta CDF	.34	PG/L	0.500	ND	ND	ND	ND
1,2,3,4,7,8-hexa CDF	.284	PG/L	0.100	ND	ND	ND	ND
1,2,3,6,7,8-hexa CDF	.281	PG/L	0.100	ND	ND	ND	ND
1,2,3,7,8,9-hexa CDF	.348	PG/L	0.100	ND	ND	ND	ND
2,3,4,6,7,8-hexa CDF	.294	PG/L	0.100	ND	ND	ND	ND
1,2,3,4,6,7,8-hepta CDF	.295	PG/L	0.010	ND	ND	ND	ND
1,2,3,4,7,8,9-hepta CDF	.397	PG/L	0.010	ND	ND	ND	ND
octa CDF	.738	PG/L	0.001	ND	ND	ND	ND

Above are permit required CDD/CDF isomers.

ND= not detected

DNQ=Detected not quantifiable, result value is below calibration range but greater or equal MDL.

This page left blank intentionally

## V. Ocean Monitoring Data Summary

- A. Ocean Sediment Chemistry Data Tables.
- B. Fish Tissue Chemistry Data Tables.
- C. Seawaters Chemistry Data Tables.

This page is left blank intentionally

Maps, with sampling sites labeled, are included in this section.

Summary of Sampling Technique<sup>6</sup>:

### Sediments

Benthic sediment is obtained using a 0.1m<sup>2</sup>, chain-rigged Tandem van Veen grab sampler deployed from a City ocean monitoring vessel. Sediment samples are collected from the top 2 cm of an undisturbed grab surface and then placed into an appropriately labeled sample container. Subsamples are placed on ice and subsequently shipped to the laboratory for chemical analysis. Preservatives are used in accordance with the requirements of 40 CFR and our Quality Assurance Plan. Sediment concentrations are based on the dry weight of a sample.

### Fish Tissue

Several species of flat fish and rock fish are taken by Otter trawls and/or rig fishing. The dissected muscle and liver tissues are frozen and delivered to the laboratory for analysis. Tissue samples are kept frozen until prepared for analyses.

---

<sup>6</sup> For complete description of the sampling protocols, dissections, equipment, vessels, etc. related to the sampling of ocean sediments and fish, please refer to the City of San Diego, Annual Receiving Waters Monitoring Report 2011

## A. Ocean Sediment Chemistries.

The data for Biochemical Oxygen Demand (BOD) and Total Volatile Solids (TVS), all measures of organic enrichment, as well as total sulfides and temperature, are all presented by quarter and averaged. The quarterly particle size analysis does not lend itself to summarization and each quarter's analysis is presented separately. For the data from all the metals, cyanide, radiation and all of the numerous organic priority pollutant analyses (except dioxin, presented by quarter) only the average of the four quarters is presented here; the values for each quarter has been reported in the Quarterly Monitoring Reports.

### Station

I-1	I-12	I-23
I-2	I-13	I-27
I-3	I-14	I-28
I-4	I-15	I-29
I-6	I-16	I-30
I-7	I-18	I-31
I-8	I-20	I-33
I-9	I-21	I-34
I-10	I-22	I-35

# SBWRP Regular Fixed Grid Ocean sediment (benthic) stations

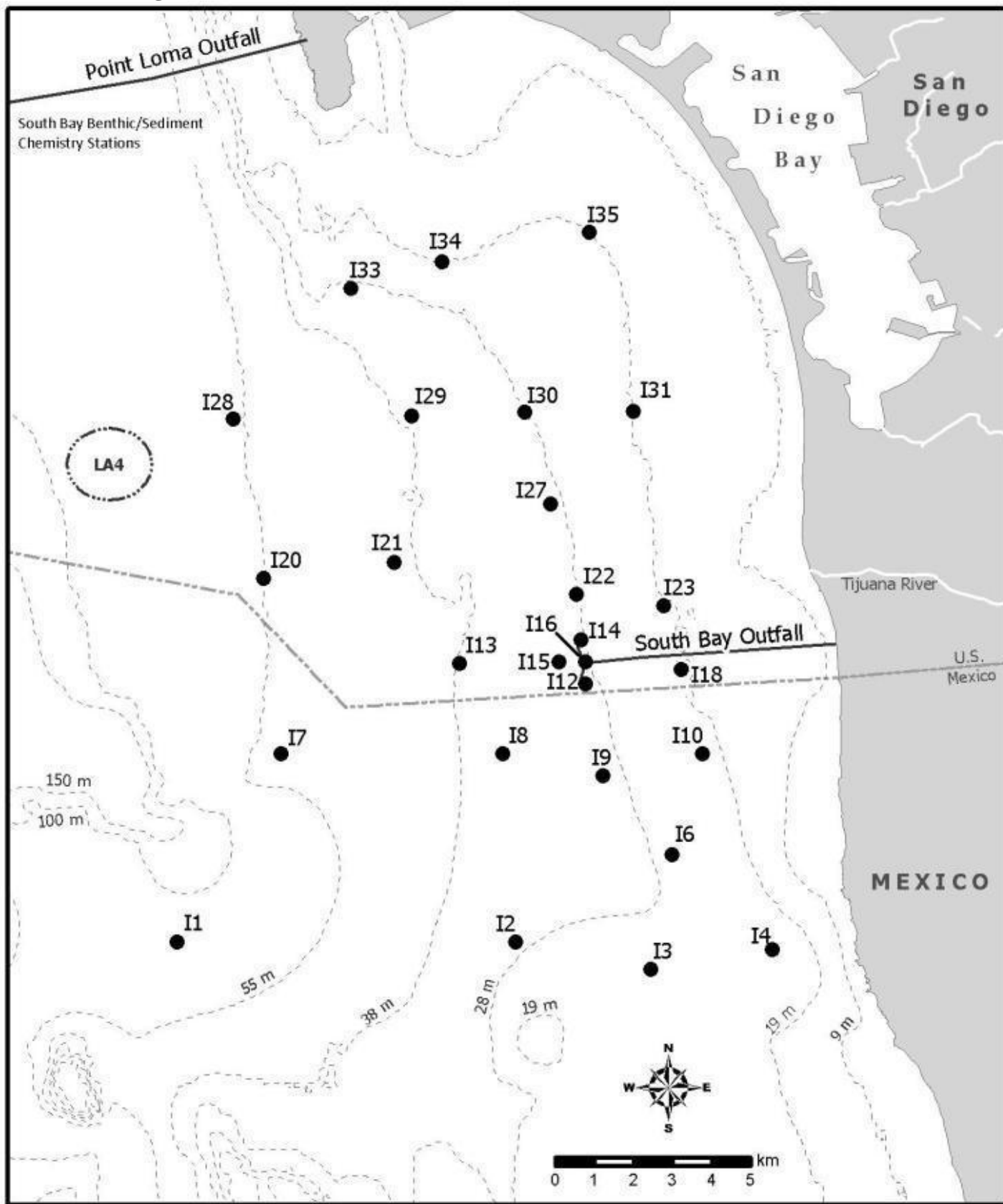

SOUTH BAY OCEAN OUTFALL MONITORING  
SEDIMENT ANNUAL - International Stations

Sulfide and Total Volatile Solids Analysis

Annual 2013

Source:		I-1	I-2	I-3	I-4	I-6	I-7	I-8	I-9	I-10
Date:		2013	2013	2013	2013	2013	2013	2013	2013	2013
Analyte	MDL Units	Avg	Avg	Avg	Avg	Avg	Avg	Avg	Avg	Avg
Sulfides-Total	.14 MG/KG	1.20	1.66	0.49	1.45	1.09	1.50	1.46	1.41	1.83
Total Volatile Solids	.11 WT%	0.99	0.43	0.31	0.70	0.72	0.57	0.45	1.18	0.85

Source:		I-12	I-13	I-14	I-15	I-16	I-18	I-20	I-21	I-22
Date:		2013	2013	2013	2013	2013	2013	2013	2013	2013
Analyte	MDL Units	Avg	Avg	Avg	Avg	Avg	Avg	Avg	Avg	Avg
Sulfides-Total	.14 MG/KG	2.91	0.79	2.01	0.43	3.16	4.12	0.24	0.28	1.52
Total Volatile Solids	.11 WT%	0.94	0.69	1.05	0.50	0.78	0.81	0.38	0.70	0.99

Source:		I-23	I-27	I-28	I-29	I-30	I-31	I-33	I-34	I-35
Date:		2013	2013	2013	2013	2013	2013	2013	2013	2013
Analyte	MDL Units	Avg	Avg	Avg	Avg	Avg	Avg	Avg	Avg	Avg
Sulfides-Total	.14 MG/KG	1.24	2.48	2.75	0.88	2.00	2.08	9.56	1.31	6.15
Total Volatile Solids	.11 WT%	0.84	1.03	1.73	1.11	1.09	0.67	1.49	0.58	1.34

ND=not detected



SOUTH BAY OCEAN OUTFALL MONITORING  
SEDIMENT ANNUAL - International Stations

Grain Size  
(all values are in percent distribution)

ANNUAL 2013

Source:		I-1	I-1	I-2	I-2	I-3	I-3	I-4
Sample ID:		P647312	P668516	P647327	P668530	P647331	P668538	P647337
Analyte	Units	02-JAN-2013	01-JUL-2013	02-JAN-2013	01-JUL-2013	02-JAN-2013	01-JUL-2013	02-JAN-2013
>0.5 to 1.0		0.000	0.000	0.000	0.000	0.000	0.000	0.000
>1.0 to 2.0		0.000	0.065	0.000	0.000	0.000	0.000	0.000
>2.0 to 3.9		0.587	0.909	0.000	0.000	0.000	0.000	0.108
>3.9 to 7.8		1.710	2.590	0.000	0.998	0.000	0.240	0.832
>7.8 to 15.6		2.630	4.150	0.476	1.840	0.000	0.723	1.260
>15.6 to 31		2.340	2.700	0.314	1.200	0.000	0.211	1.670
>31 to 62.5		4.600	5.660	0.165	0.916	0.000	0.000	10.300
>62.5 to 125		34.600	38.300	2.830	4.350	0.066	0.392	56.600
>125 to 250		46.100	39.500	31.000	41.800	4.460	7.300	25.400
>250 to 500		7.380	6.080	44.900	44.300	28.200	30.900	3.730
>500 to 1000		0.110	0.106	17.200	4.550	58.800	52.000	0.086
>1000 to 2000		0.000	0.000	3.090	0.000	8.430	8.200	0.000
>2000*		ND	ND	ND	ND	ND	ND	ND
Totals:		100.057	100.060	99.975	99.954	99.956	99.966	99.986

Source:		I-4	I-6	I-6	I-7	I-7	I-8	I-8
Sample ID:		P668541	P647345	P668547	P647347	P668552	P647354	P668557
Analyte	Units	01-JUL-2013	02-JAN-2013	01-JUL-2013	02-JAN-2013	01-JUL-2013	02-JAN-2013	01-JUL-2013
>0.5 to 1.0		0.000	0.000	0.000	0.000	0.000	0.000	0.000
>1.0 to 2.0		0.000	0.000	0.000	0.000	0.507	0.000	0.000
>2.0 to 3.9		0.363	0.000	0.000	0.129	2.440	0.000	0.000
>3.9 to 7.8		1.290	0.000	0.438	1.170	9.090	0.119	0.900
>7.8 to 15.6		2.230	0.341	1.070	1.740	16.400	0.623	1.410
>15.6 to 31		2.060	0.603	0.868	1.300	8.450	0.311	0.834
>31 to 62.5		10.400	1.550	1.010	0.851	4.370	0.349	0.861
>62.5 to 125		54.100	4.060	2.280	1.620	8.790	3.020	3.950
>125 to 250		24.600	16.700	19.300	6.440	32.100	23.200	23.400
>250 to 500		4.820	44.300	64.200	27.100	17.800	47.500	39.200
>500 to 1000		0.119	28.200	10.800	51.200	0.087	21.500	25.500
>1000 to 2000		0.000	4.270	0.052	8.440	0.000	3.420	3.960
>2000*		ND	ND	ND	ND	ND	ND	ND
Totals:		99.982	100.024	100.018	99.990	100.034	100.042	100.015

\*=A value in this field reflects a percentage of 30 grams remaining on a 2000 micron sieve. This value must be subtracted from the total percentage.

SOUTH BAY OCEAN OUTFALL MONITORING  
SEDIMENT ANNUAL - International Stations

Grain Size  
(all values are in percent distribution)

ANNUAL 2013

Source:		I-9	I-9	I-10	I-10	I-12	I-12	I-13
Sample ID:		P647360	P668561	P647316	P668525	P647407	P668649	P647324
Analyte	Units	02-JAN-2013	01-JUL-2013	02-JAN-2013	01-JUL-2013	03-JAN-2013	03-JUL-2013	02-JAN-2013
>0.5 to 1.0		0.000	0.000	0.000	0.000	0.000	0.000	0.000
>1.0 to 2.0		0.000	0.241	0.000	0.000	0.000	0.008	0.000
>2.0 to 3.9		0.508	0.931	0.114	0.244	0.428	0.753	0.000
>3.9 to 7.8		1.170	2.240	0.937	1.210	1.410	2.000	0.516
>7.8 to 15.6		1.720	3.700	1.450	2.100	2.150	3.350	0.821
>15.6 to 31		2.570	3.580	1.670	1.960	2.470	2.820	0.708
>31 to 62.5		17.500	18.300	7.750	9.300	9.740	10.600	0.900
>62.5 to 125		57.700	54.000	57.100	57.000	47.000	43.500	3.730
>125 to 250		16.800	14.500	28.500	25.000	32.800	28.100	17.200
>250 to 500		2.010	2.360	2.510	3.110	3.920	8.230	45.800
>500 to 1000		0.053	0.067	0.048	0.073	0.045	0.584	26.900
>1000 to 2000		0.000	0.000	0.000	0.000	0.000	0.000	3.410
>2000*		ND	ND	ND	ND	ND	ND	ND
Totals:		100.031	99.919	100.079	99.997	99.963	99.945	99.985

Source:		I-13	I-14	I-14	I-15	I-15	I-16	I-16
Sample ID:		P668658	P647416	P668661	P647421	P668666	P647426	P668669
Analyte	Units	03-JUL-2013	03-JAN-2013	03-JUL-2013	03-JAN-2013	03-JUL-2013	03-JAN-2013	03-JUL-2013
>0.5 to 1.0		0.000	0.000	0.000	0.000	0.000	0.000	0.000
>1.0 to 2.0		0.009	0.000	0.118	0.000	0.000	0.000	0.000
>2.0 to 3.9		0.971	0.576	0.850	0.000	0.261	0.107	0.408
>3.9 to 7.8		2.870	1.540	2.120	0.733	1.450	0.919	1.560
>7.8 to 15.6		4.340	2.380	3.540	1.110	2.480	1.460	2.740
>15.6 to 31		2.470	2.890	3.240	1.450	1.890	1.530	2.350
>31 to 62.5		3.140	13.700	15.200	5.410	3.610	3.610	8.500
>62.5 to 125		16.800	56.500	55.100	16.900	7.140	19.200	43.500
>125 to 250		39.200	20.400	17.100	37.300	22.700	40.300	33.200
>250 to 500		26.600	2.090	2.680	33.300	52.700	24.700	7.310
>500 to 1000		3.600	0.042	0.071	3.770	7.760	8.110	0.446
>1000 to 2000		0.000	0.000	0.000	0.000	0.000	0.057	0.000
>2000*		ND	ND	ND	ND	ND	ND	ND
Totals:		100.000	100.118	100.019	99.973	99.991	99.993	100.014

\*=A value in this field reflects a percentage of 30 grams remaining on a 2000 micron sieve. This value must be subtracted from the total percentage.

SOUTH BAY OCEAN OUTFALL MONITORING  
SEDIMENT ANNUAL - International Stations

Grain Size  
(all values are in percent distribution)

ANNUAL 2013

Source:		I-18	I-18	I-20	I-20	I-21	I-21	I-22
Sample ID:		P647428	P668677	P647434	P668535	P647441	P668683	P647444
Analyte	Units	03-JAN-2013	03-JUL-2013	03-JAN-2013	01-JUL-2013	03-JAN-2013	03-JUL-2013	03-JAN-2013
>0.5 to 1.0		0.000	0.000	0.000	0.000	0.000	0.000	0.000
>1.0 to 2.0		0.000	0.000	0.000	0.495	0.000	0.000	0.000
>2.0 to 3.9		0.110	0.238	0.000	2.270	0.000	0.122	0.654
>3.9 to 7.8		0.875	1.170	0.000	7.800	0.000	1.260	1.820
>7.8 to 15.6		1.280	1.990	0.000	13.100	0.000	2.140	2.950
>15.6 to 31		1.510	1.930	0.000	6.810	0.000	1.340	3.510
>31 to 62.5		8.770	10.900	0.000	3.650	0.047	0.982	12.100
>62.5 to 125		60.200	60.600	0.439	6.050	1.150	1.640	47.600
>125 to 250		24.900	21.000	5.990	37.900	9.090	7.430	26.900
>250 to 500		2.240	2.080	23.800	21.800	46.600	34.600	4.400
>500 to 1000		0.049	0.047	60.300	0.082	39.300	44.400	0.092
>1000 to 2000		0.000	0.000	9.480	0.000	3.800	6.110	0.000
>2000*		ND	ND	ND	ND	ND	ND	ND
Totals:		99.934	99.955	100.009	99.957	99.987	100.024	100.026

Source:		I-22	I-23	I-23	I-27	I-27	I-28	I-29
Sample ID:		P668686	P647450	P668689	P647454	P670528	P668791	P647541
Analyte	Units	03-JUL-2013	03-JAN-2013	03-JUL-2013	03-JAN-2013	12-JUL-2013	08-JUL-2013	04-JAN-2013
>0.5 to 1.0		0.000	0.000	0.000	0.000	0.000	0.105	0.000
>1.0 to 2.0		0.122	0.000	0.000	0.008	0.008	1.280	0.590
>2.0 to 3.9		0.895	0.387	0.505	0.760	0.729	3.620	1.840
>3.9 to 7.8		2.280	1.290	1.410	1.600	1.780	9.390	4.670
>7.8 to 15.6		3.850	2.090	2.530	2.400	2.940	13.500	7.600
>15.6 to 31		3.480	2.480	2.620	3.110	2.780	9.400	8.400
>31 to 62.5		14.000	9.760	12.400	15.200	15.400	18.500	12.200
>62.5 to 125		50.300	54.400	57.800	57.300	59.200	32.700	19.100
>125 to 250		21.400	26.000	20.200	17.800	15.300	10.300	33.300
>250 to 500		3.630	3.510	2.430	1.810	1.820	1.120	12.200
>500 to 1000		0.084	0.084	0.062	0.042	0.048	0.000	0.079
>1000 to 2000		0.000	0.000	0.000	0.000	0.000	0.000	0.000
>2000*		ND	ND	ND	ND	ND	1.680	ND
Totals:		100.041	100.001	99.957	100.030	100.005	101.595	99.979

\*=A value in this field reflects a percentage of 30 grams remaining on a 2000 micron sieve. This value must be subtracted from the total percentage.

SOUTH BAY OCEAN OUTFALL MONITORING  
SEDIMENT ANNUAL - International Stations

Grain Size  
(all values are in percent distribution)

ANNUAL 2013

Source:		I-29	I-30	I-30	I-31	I-31	I-33	I-33
Sample ID:		P668795	P647546	P670534	P647551	P668696	P647556	P670536
Analyte	Units	08-JUL-2013	04-JAN-2013	12-JUL-2013	04-JAN-2013	03-JUL-2013	04-JAN-2013	12-JUL-2013
>0.5 to 1.0		0.000	0.000	0.000	0.000	0.000	0.000	0.000
>1.0 to 2.0		0.480	0.000	0.257	0.000	0.000	0.112	0.125
>2.0 to 3.9		1.350	0.577	1.130	0.222	0.372	0.904	1.100
>3.9 to 7.8		3.230	1.470	2.970	1.000	1.380	2.260	3.210
>7.8 to 15.6		5.400	2.150	4.730	1.540	2.240	3.880	5.000
>15.6 to 31		6.000	2.700	3.860	1.660	1.730	4.190	3.130
>31 to 62.5		21.800	15.600	16.600	7.920	8.690	7.140	6.440
>62.5 to 125		44.600	60.500	54.300	60.500	62.000	41.100	43.900
>125 to 250		14.700	16.000	14.100	25.100	21.600	35.600	33.000
>250 to 500		2.330	1.040	1.950	1.960	1.950	4.670	4.010
>500 to 1000		0.054	0.000	0.052	0.042	0.046	0.091	0.076
>1000 to 2000		0.000	0.000	0.000	0.000	0.000	0.000	0.000
>2000*		ND	ND	ND	ND	ND	ND	ND
Totals:		99.944	100.037	99.949	99.944	100.008	99.947	99.991

Source:		I-34	I-35	I-35
Sample ID:		P670545	P647566	P670548
Analyte	Units	12-JUL-2013	04-JAN-2013	12-JUL-2013
>0.5 to 1.0		0.000	0.000	0.000
>1.0 to 2.0		0.000	0.568	0.407
>2.0 to 3.9		0.122	1.300	1.200
>3.9 to 7.8		1.280	2.730	2.890
>7.8 to 15.6		2.320	5.090	5.830
>15.6 to 31		1.550	9.560	8.180
>31 to 62.5		1.520	23.700	23.200
>62.5 to 125		7.320	38.100	40.800
>125 to 250		48.700	16.200	15.100
>250 to 500		33.800	2.750	2.340
>500 to 1000		3.350	0.062	0.048
>1000 to 2000		0.000	0.000	0.000
>2000*		ND	ND	ND
Totals:		99.962	100.060	99.995

\*=A value in this field reflects a percentage of 30 grams remaining on a 2000 micron sieve. This value must be subtracted from the total percentage.

SOUTH BAY WATER RECLAMATION PLANT  
 SEDIMENT ANNUAL - International Stations

Total Organic Carbon/Total Nitrogen

Annual 2013

Source:			I-1	I-2	I-3	I-4	I-6	I-7
Date:			2013	2013	2013	2013	2013	2013
Analyte	MDL	Units	Avg	Avg	Avg	Avg	Avg	Avg
Total Nitrogen	.005	WT%	0.025	0.012	0.006	0.020	0.010	0.012
Total Organic Carbon	.01	WT%	0.167	0.047	0.020	0.098	0.032	0.059

Source:			I-8	I-9	I-10	I-12	I-13	I-14
Date:			2013	2013	2013	2013	2013	2013
Analyte	MDL	Units	Avg	Avg	Avg	Avg	Avg	Avg
Total Nitrogen	.005	WT%	0.012	0.026	0.020	0.025	0.016	0.026
Total Organic Carbon	.01	WT%	0.055	0.171	0.110	0.147	0.084	0.170

Source:			I-15	I-16	I-18	I-20	I-21	I-22
Date:			2013	2013	2013	2013	2013	2013
Analyte	MDL	Units	Avg	Avg	Avg	Avg	Avg	Avg
Total Nitrogen	.005	WT%	0.013	0.022	0.018	0.011	0.011	0.024
Total Organic Carbon	.01	WT%	0.060	0.132	0.099	0.034	0.037	0.153

Source:			I-23	I-27	I-28	I-29	I-30	I-31
Date:			2013	2013	2013	2013	2013	2013
Analyte	MDL	Units	Avg	Avg	Avg	Avg	Avg	Avg
Total Nitrogen	.005	WT%	0.019	0.022	0.046	0.027	0.023	0.016
Total Organic Carbon	.01	WT%	0.113	0.148	0.398	0.200	0.152	0.095

Source:			I-33	I-34	I-35
Date:			2013	2013	2013
Analyte	MDL	Units	Avg	Avg	Avg
Total Nitrogen	.005	WT%	0.036	0.007	0.033
Total Organic Carbon	.01	WT%	0.275	0.878	0.244

ND=not detected

SOUTH BAY WASTEWATER RECLAMATION PLANT  
SEDIMENT ANNUAL - International Stations

Trace Metals

Annual 2013

Source:			I-1	I-2	I-3	I-4	I-6
Date:			2013	2013	2013	2013	2013
Analyte	MDL	Units	Average	Average	Average	Average	Average
=====	=====	=====	=====	=====	=====	=====	=====
Aluminum	2	MG/KG	4750	3960	1870	6380	2250
Antimony	.3	MG/KG	0.3	0.3	<0.3	0.4	0.4
Arsenic	.33	MG/KG	1.07	0.92	1.94	1.40	4.58
Beryllium	.01	MG/KG	0.08	0.06	0.03	0.07	0.05
Cadmium	.06	MG/KG	<0.06	0.07	ND	0.07	0.08
Chromium	.1	MG/KG	8.1	7.5	5.5	9.9	9.1
Copper	.2	MG/KG	1.2	1.3	0.5	2.3	0.7
Iron	9	MG/KG	5440	3590	1860	6420	4570
Lead	.8	MG/KG	2.8	1.8	1.0	1.6	1.8
Manganese	.08	MG/KG	120	56.2	17	119	39.7
Mercury	.004	MG/KG	0.006	ND	ND	ND	ND
Nickel	.1	MG/KG	3.2	2.7	1.5	3.5	1.5
Selenium	.24	MG/KG	0.31	0.34	0.43	<0.24	<0.24
Silver	.04	MG/KG	ND	ND	<0.04	ND	0.2
Thallium	.5	MG/KG	ND	ND	ND	1.6	ND
Tin	.3	MG/KG	0.6	1.2	1.1	0.8	1.1
Zinc	.25	MG/KG	9.2	7.2	2.8	12.3	4.8

Source:			I-7	I-8	I-9	I-10	I-12
Date:			2013	2013	2013	2013	2013
Analyte	MDL	Units	Average	Average	Average	Average	Average
=====	=====	=====	=====	=====	=====	=====	=====
Aluminum	2	MG/KG	2880	3580	14200	10900	10500
Antimony	.3	MG/KG	0.4	0.5	0.8	0.4	0.9
Arsenic	.33	MG/KG	6.03	2.64	1.86	1.45	1.79
Beryllium	.01	MG/KG	0.07	0.08	0.18	0.14	0.17
Cadmium	.06	MG/KG	0.15	0.20	0.29	<0.06	0.36
Chromium	.1	MG/KG	10.9	11.3	17.3	14.4	14.7
Copper	.2	MG/KG	1.0	0.9	5.4	3.1	3.9
Iron	9	MG/KG	7640	5320	11500	11300	10300
Lead	.8	MG/KG	3.2	2.7	6.0	4.2	5.2
Manganese	.08	MG/KG	50.5	55.4	164	225	170
Mercury	.004	MG/KG	ND	ND	<0.004	ND	0.004
Nickel	.1	MG/KG	2.1	2.4	7.2	4.7	5.1
Selenium	.24	MG/KG	ND	<0.24	0.28	0.34	0.38
Silver	.04	MG/KG	0.1	0.2	ND	ND	ND
Thallium	.5	MG/KG	ND	ND	ND	ND	ND
Tin	.3	MG/KG	1.4	1.7	1.8	0.5	1.5
Zinc	.25	MG/KG	7.5	8.7	27.5	21.9	23.8

ND= not detected

SOUTH BAY WASTEWATER RECLAMATION PLANT  
SEDIMENT ANNUAL - International Stations

Trace Metals

Annual 2013

Source:		I-13	I-14	I-15	I-16	I-18
Date:		2013	2013	2013	2013	2013
Analyte	MDL Units	Average	Average	Average	Average	Average
Aluminum	2 MG/KG	4290	12800	4610	8620	9730
Antimony	.3 MG/KG	0.4	1.0	1.1	1.1	0.6
Arsenic	.33 MG/KG	3.28	1.81	2.83	1.48	1.38
Beryllium	.01 MG/KG	0.09	0.20	0.11	0.16	0.16
Cadmium	.06 MG/KG	ND	0.46	0.50	0.48	<0.06
Chromium	.1 MG/KG	11.8	16.8	12.5	12.6	14.8
Copper	.2 MG/KG	1.3	4.8	1.6	3.4	2.9
Iron	9 MG/KG	7960	11100	6660	9080	11800
Lead	.8 MG/KG	3.3	6.3	3.7	4.4	3.7
Manganese	.08 MG/KG	141	194	91.5	184	248
Mercury	.004 MG/KG	<0.004	0.005	ND	ND	ND
Nickel	.1 MG/KG	2.3	6.2	3.0	4.3	4.2
Selenium	.24 MG/KG	0.42	0.43	<0.24	0.43	0.41
Silver	.04 MG/KG	ND	ND	ND	0.2	0.1
Thallium	.5 MG/KG	ND	ND	ND	ND	ND
Tin	.3 MG/KG	0.5	2.0	2.3	1.8	0.6
Zinc	.25 MG/KG	10.3	25.1	12.8	18.9	21.4

Source:		I-20	I-21	I-22	I-23	I-27
Date:		2013	2013	2013	2013	2013
Analyte	MDL Units	Average	Average	Average	Average	Average
Aluminum	2 MG/KG	2720	2660	9980	8580	10300
Antimony	.3 MG/KG	<0.3	<0.3	0.4	0.9	0.5
Arsenic	.33 MG/KG	3.86	10.4	1.55	1.48	1.55
Beryllium	.01 MG/KG	0.08	0.10	0.15	0.15	0.16
Cadmium	.06 MG/KG	ND	0.08	<0.06	0.08	0.08
Chromium	.1 MG/KG	5.7	12.4	13.1	11.6	11.9
Copper	.2 MG/KG	0.7	1.1	3.3	2.9	3.8
Iron	9 MG/KG	5510	8910	9470	9070	7960
Lead	.8 MG/KG	2.0	3.5	4.0	3.2	3.9
Manganese	.08 MG/KG	25.7	30.5	192	220	131
Mercury	.004 MG/KG	ND	ND	0.004	<0.004	0.07
Nickel	.1 MG/KG	1.6	1.6	4.6	4.9	5.9
Selenium	.24 MG/KG	0.47	0.33	0.40	0.43	0.35
Silver	.04 MG/KG	ND	ND	ND	5.6	1.3
Thallium	.5 MG/KG	ND	ND	ND	ND	ND
Tin	.3 MG/KG	1.4	1.2	0.8	0.7	1.0
Zinc	.25 MG/KG	6.4	7.4	19.2	19.6	20.4

ND= not detected

SOUTH BAY WASTEWATER RECLAMATION PLANT  
SEDIMENT ANNUAL - International Stations

Trace Metals

Annual 2013

Source:			I-28	I-29	I-30	I-31	I-33
Date:			2013	2013	2013	2013	2013
Analyte	MDL	Units	Average	Average	Average	Average	Average
=====	=====	=====	=====	=====	=====	=====	=====
Aluminum	2	MG/KG	9960	8090	10700	7580	9220
Antimony	.3	MG/KG	0.6	0.3	0.5	0.9	0.5
Arsenic	.33	MG/KG	2.32	3.28	1.77	1.24	1.70
Beryllium	.01	MG/KG	0.19	0.15	0.16	0.14	0.16
Cadmium	.06	MG/KG	0.12	<0.06	0.09	0.08	0.10
Chromium	.1	MG/KG	11.8	10.5	12.0	9.8	10.1
Copper	.2	MG/KG	7.0	3.7	3.9	2.0	4.5
Iron	9	MG/KG	9300	8810	7690	7840	8020
Lead	.8	MG/KG	5.5	4.0	4.2	3.0	5.3
Manganese	.08	MG/KG	144	130	116	226	153
Mercury	.004	MG/KG	0.021	0.008	0.006	ND	0.018
Nickel	.1	MG/KG	8.0	5.3	5.8	4.1	5.3
Selenium	.24	MG/KG	0.49	0.35	0.34	0.45	<0.24
Silver	.04	MG/KG	1.8	2.8	1.0	4.8	1.5
Thallium	.5	MG/KG	ND	ND	ND	ND	ND
Tin	.3	MG/KG	1.1	0.8	1.1	0.7	1.0
Zinc	.25	MG/KG	22.5	17.7	20.3	16.6	21.0

Source:			I-34	I-35
Date:			2013	2013
Analyte	MDL	Units	Average	Average
=====	=====	=====	=====	=====
Aluminum	2	MG/KG	4150	15000
Antimony	.3	MG/KG	ND	0.6
Arsenic	.33	MG/KG	2.34	2.57
Beryllium	.01	MG/KG	0.08	0.21
Cadmium	.06	MG/KG	ND	0.15
Chromium	.1	MG/KG	4.3	16
Copper	.2	MG/KG	1.4	7.1
Iron	9	MG/KG	4170	12700
Lead	.8	MG/KG	2.6	6.6
Manganese	.08	MG/KG	74.3	208
Mercury	.004	MG/KG	<0.004	0.022
Nickel	.1	MG/KG	3.1	7.8
Selenium	.24	MG/KG	<0.24	<0.24
Silver	.04	MG/KG	0.6	2.2
Thallium	.5	MG/KG	ND	ND
Tin	.3	MG/KG	1.0	1.0
Zinc	.25	MG/KG	8.9	34.0

ND= not detected



SOUTH BAY OCEAN OUTFALL MONITORING  
 SEDIMENT ANNUAL Chlorinated Pesticide Analysis - International Stations

Annual 2013

Source:			I-1	I-2	I-3	I-4	I-6	I-7	I-8	I-9
Date:			2013	2013	2013	2013	2013	2013	2013	2013
Analyte	MDL	Units	Avg	Avg	Avg	Avg	Avg	Avg	Avg	Avg
=====	=====	=====	=====	=====	=====	=====	=====	=====	=====	=====
Aldrin	430	NG/KG	ND	ND	ND	ND	ND	ND	ND	ND
Dieldrin	340	NG/KG	ND	ND	ND	ND	ND	ND	ND	ND
BHC, Alpha isomer	150	NG/KG	ND	ND	ND	ND	ND	ND	ND	ND
BHC, Beta isomer	310	NG/KG	ND	ND	ND	ND	ND	ND	ND	ND
BHC, Gamma isomer	260	NG/KG	ND	ND	ND	ND	ND	ND	ND	ND
BHC, Delta isomer	700	NG/KG	ND	ND	ND	ND	ND	ND	ND	ND
p,p-DDD	470	NG/KG	ND	ND	ND	ND	ND	ND	ND	ND
p,p-DDE	260	NG/KG	<260	ND	<260	ND	ND	ND	ND	<260
p,p-DDT	800	NG/KG	ND	ND	ND	ND	ND	ND	ND	ND
o,p-DDD	830	NG/KG	ND	ND	ND	ND	ND	ND	ND	ND
o,p-DDE	720	NG/KG	ND	ND	ND	ND	ND	ND	ND	ND
o,p-DDT	800	NG/KG	ND	ND	ND	ND	ND	ND	ND	ND
Heptachlor	1200	NG/KG	ND	ND	ND	ND	ND	ND	ND	ND
Heptachlor epoxide	300	NG/KG	ND	ND	ND	ND	ND	ND	ND	ND
Alpha (cis) Chlordane	240	NG/KG	ND	ND	ND	ND	ND	ND	ND	ND
Gamma (trans) Chlordane	350	NG/KG	ND	ND	ND	ND	ND	ND	ND	ND
Alpha Chlordene		NG/KG	NA	NA	NA	NA	NA	NA	NA	NA
Gamma Chlordene		NG/KG	NA	NA	NA	NA	NA	NA	NA	NA
Oxychlordane	1200	NG/KG	ND	ND	ND	ND	ND	ND	ND	ND
Trans Nonachlor	250	NG/KG	ND	ND	ND	ND	ND	ND	ND	ND
Cis Nonachlor	380	NG/KG	ND	ND	ND	ND	ND	ND	ND	ND
Alpha Endosulfan	720	NG/KG	ND	ND	ND	ND	ND	ND	ND	ND
Beta Endosulfan	780	NG/KG	ND	ND	ND	ND	ND	ND	ND	ND
Endosulfan Sulfate	1100	NG/KG	ND	ND	ND	ND	ND	ND	ND	ND
Endrin	830	NG/KG	ND	ND	ND	ND	ND	ND	ND	ND
Endrin aldehyde	2400	NG/KG	ND	ND	ND	ND	ND	ND	ND	ND
Mirex	500	NG/KG	ND	ND	ND	ND	ND	ND	ND	ND
Methoxychlor	1100	NG/KG	ND	ND	ND	ND	ND	ND	ND	ND
=====	=====	=====	=====	=====	=====	=====	=====	=====	=====	=====
Aldrin + Dieldrin	430	NG/KG	0	0	0	0	0	0	0	0
Hexachlorocyclohexanes	700	NG/KG	0	0	0	0	0	0	0	0
DDT and derivatives	830	NG/KG	0	0	0	0	0	0	0	0
Chlordane + related cmpds.	1200	NG/KG	0	0	0	0	0	0	0	0
=====	=====	=====	=====	=====	=====	=====	=====	=====	=====	=====
Chlorinated Hydrocarbons	2400	NG/KG	0	0	0	0	0	0	0	0

ND=not detected  
 NA=not analyzed

Standards for alpha and gamma chlordene are no longer available in the U.S. for the analysis of these compounds.

SOUTH BAY OCEAN OUTFALL MONITORING  
 SEDIMENT ANNUAL Chlorinated Pesticide Analysis - International Stations

Annual 2013

Source:			I-10	I-12	I-13	I-14	I-15	I-16	I-18	I-20
Date:			2013	2013	2013	2013	2013	2013	2013	2013
Analyte	MDL	Units	Avg	Avg	Avg	Avg	Avg	Avg	Avg	Avg
=====	=====	=====	=====	=====	=====	=====	=====	=====	=====	=====
Aldrin	430	NG/KG	ND	ND	ND	ND	ND	ND	ND	ND
Dieldrin	340	NG/KG	ND	ND	ND	ND	ND	ND	ND	ND
BHC, Alpha isomer	150	NG/KG	ND	ND	ND	ND	ND	ND	ND	395
BHC, Beta isomer	310	NG/KG	ND	ND	ND	ND	ND	ND	ND	<310
BHC, Gamma isomer	260	NG/KG	ND	ND	ND	ND	ND	ND	ND	ND
BHC, Delta isomer	700	NG/KG	ND	ND	ND	ND	ND	ND	ND	ND
p,p-DDD	470	NG/KG	ND	ND	ND	ND	ND	ND	ND	ND
p,p-DDE	260	NG/KG	ND	E160	ND	<260	ND	ND	ND	<260
p,p-DDT	800	NG/KG	ND	ND	ND	ND	ND	ND	ND	ND
o,p-DDD	830	NG/KG	ND	ND	ND	ND	ND	ND	ND	ND
o,p-DDE	720	NG/KG	ND	ND	ND	ND	ND	ND	ND	ND
o,p-DDT	800	NG/KG	ND	ND	ND	ND	ND	ND	ND	ND
Heptachlor	1200	NG/KG	ND	ND	ND	ND	ND	ND	ND	E205
Heptachlor epoxide	300	NG/KG	ND	ND	ND	ND	ND	ND	ND	ND
Alpha (cis) Chlordane	240	NG/KG	ND	ND	ND	ND	ND	ND	ND	ND
Gamma (trans) Chlordane	350	NG/KG	ND	ND	ND	ND	ND	ND	ND	ND
Alpha Chlordene		NG/KG	NA	NA	NA	NA	NA	NA	NA	NA
Gamma Chlordene		NG/KG	NA	NA	NA	NA	NA	NA	NA	NA
Oxychlordane	1200	NG/KG	ND	ND	ND	ND	ND	ND	ND	ND
Trans Nonachlor	250	NG/KG	ND	ND	ND	ND	ND	ND	ND	ND
Cis Nonachlor	380	NG/KG	ND	ND	ND	ND	ND	ND	ND	ND
Alpha Endosulfan	720	NG/KG	ND	ND	ND	ND	ND	ND	ND	ND
Beta Endosulfan	780	NG/KG	ND	ND	ND	ND	ND	ND	ND	ND
Endosulfan Sulfate	1100	NG/KG	ND	ND	ND	ND	ND	ND	ND	ND
Endrin	830	NG/KG	ND	ND	ND	ND	ND	ND	ND	ND
Endrin aldehyde	2400	NG/KG	ND	ND	ND	ND	ND	ND	ND	ND
Mirex	500	NG/KG	ND	ND	ND	ND	ND	ND	ND	ND
Methoxychlor	1100	NG/KG	ND	ND	ND	ND	ND	ND	ND	ND
=====	=====	=====	=====	=====	=====	=====	=====	=====	=====	=====
Aldrin + Dieldrin	430	NG/KG	0	0	0	0	0	0	0	0
Hexachlorocyclohexanes	700	NG/KG	0	0	0	0	0	0	0	395
DDT and derivatives	830	NG/KG	0	0	0	0	0	0	0	0
Chlordane + related cmpds.	1200	NG/KG	0	0	0	0	0	0	0	0
=====	=====	=====	=====	=====	=====	=====	=====	=====	=====	=====
Chlorinated Hydrocarbons	2400	NG/KG	0	0	0	0	0	0	0	395

ND=not detected

NA=not analyzed

E=estimated value, value is less than the Method Detection Limit but confirmed by GC/MS-MS.

Standards for alpha and gamma chlordene are no longer available in the U.S. for the analysis of these compounds.

SOUTH BAY OCEAN OUTFALL MONITORING  
 SEDIMENT ANNUAL Chlorinated Pesticide Analysis - International Stations

Annual 2013

Source:			I-21	I-22	I-23	I-27	I-28	I-29	I-30	I-31
Date:			2013	2013	2013	2013	2013	2013	2013	2013
Analyte	MDL	Units	Avg	Avg	Avg	Avg	Avg	Avg	Avg	Avg
=====	=====	=====	=====	=====	=====	=====	=====	=====	=====	=====
Aldrin	430	NG/KG	ND	ND	ND	ND	ND	ND	ND	ND
Dieldrin	340	NG/KG	ND	ND	ND	ND	ND	ND	ND	ND
BHC, Alpha isomer	150	NG/KG	ND	ND	ND	ND	ND	ND	ND	ND
BHC, Beta isomer	310	NG/KG	ND	ND	ND	ND	ND	ND	ND	ND
BHC, Gamma isomer	260	NG/KG	ND	ND	ND	ND	ND	ND	ND	ND
BHC, Delta isomer	700	NG/KG	ND	ND	ND	ND	ND	ND	ND	ND
p,p-DDD	470	NG/KG	ND	<470	ND	ND	ND	ND	ND	ND
p,p-DDE	260	NG/KG	ND	E260	<260	E106	975	E440	E125	ND
p,p-DDT	800	NG/KG	ND	<800	ND	ND	E375	ND	ND	ND
o,p-DDD	830	NG/KG	ND	ND	ND	ND	ND	ND	ND	ND
o,p-DDE	720	NG/KG	ND	ND	ND	ND	ND	ND	ND	ND
o,p-DDT	800	NG/KG	ND	ND	ND	ND	ND	ND	ND	ND
Heptachlor	1200	NG/KG	ND	<1200	ND	ND	ND	ND	ND	ND
Heptachlor epoxide	300	NG/KG	ND	ND	ND	ND	ND	ND	ND	ND
Alpha (cis) Chlordane	240	NG/KG	ND	ND	ND	ND	ND	ND	ND	ND
Gamma (trans) Chlordane	350	NG/KG	ND	ND	ND	ND	ND	ND	ND	ND
Alpha Chlordene		NG/KG	NA	NA	NA	NA	NA	NA	NA	NA
Gamma Chlordene		NG/KG	NA	NA	NA	NA	NA	NA	NA	NA
Oxychlordane	1200	NG/KG	ND	ND	ND	ND	ND	ND	ND	ND
Trans Nonachlor	250	NG/KG	ND	ND	ND	ND	ND	ND	ND	ND
Cis Nonachlor	380	NG/KG	ND	ND	ND	ND	ND	ND	ND	ND
Alpha Endosulfan	720	NG/KG	ND	ND	ND	ND	ND	ND	ND	ND
Beta Endosulfan	780	NG/KG	ND	ND	ND	ND	ND	ND	ND	ND
Endosulfan Sulfate	1100	NG/KG	ND	ND	ND	ND	ND	ND	ND	ND
Endrin	830	NG/KG	ND	ND	ND	ND	ND	ND	ND	ND
Endrin aldehyde	2400	NG/KG	ND	ND	ND	ND	ND	ND	ND	ND
Mirex	500	NG/KG	ND	ND	ND	ND	ND	ND	ND	ND
Methoxychlor	1100	NG/KG	ND	ND	ND	ND	ND	ND	ND	ND
=====	=====	=====	=====	=====	=====	=====	=====	=====	=====	=====
Aldrin + Dieldrin	430	NG/KG	0	0	0	0	0	0	0	0
Hexachlorocyclohexanes	700	NG/KG	0	0	0	0	0	0	0	0
DDT and derivatives	830	NG/KG	0	0	0	0	975	0	0	0
Chlordane + related cmpds.	1200	NG/KG	0	0	0	0	0	0	0	0
=====	=====	=====	=====	=====	=====	=====	=====	=====	=====	=====
Chlorinated Hydrocarbons	2400	NG/KG	0	0	0	0	975	0	0	0

ND=not detected

NA=not analyzed

E=estimated value, value is less than the Method Detection Limit but confirmed by GC/MS-MS.

Standards for alpha and gamma chlordene are no longer available in the U.S. for the analysis of these compounds.

SOUTH BAY OCEAN OUTFALL MONITORING  
 SEDIMENT ANNUAL Chlorinated Pesticide Analysis - International Stations

Annual 2013

Source:			I-33	I-34	I-35
Date:			2013	2013	2013
Analyte	MDL	Units	Avg	Avg	Avg
=====	=====	=====	=====	=====	=====
Aldrin	430	NG/KG	ND	ND	ND
Dieldrin	340	NG/KG	ND	ND	ND
BHC, Alpha isomer	150	NG/KG	ND	ND	ND
BHC, Beta isomer	310	NG/KG	ND	ND	ND
BHC, Gamma isomer	260	NG/KG	ND	ND	ND
BHC, Delta isomer	700	NG/KG	ND	ND	ND
p,p-DDD	470	NG/KG	ND	ND	ND
p,p-DDE	260	NG/KG	<260	<260	<260
p,p-DDT	800	NG/KG	ND	ND	ND
o,p-DDD	830	NG/KG	ND	ND	ND
o,p-DDE	720	NG/KG	ND	ND	ND
o,p-DDT	800	NG/KG	ND	ND	ND
Heptachlor	1200	NG/KG	ND	ND	ND
Heptachlor epoxide	300	NG/KG	ND	ND	ND
Alpha (cis) Chlordane	240	NG/KG	ND	ND	ND
Gamma (trans) Chlordane	350	NG/KG	ND	ND	ND
Alpha Chlordene		NG/KG	NA	NA	NA
Gamma Chlordene		NG/KG	NA	NA	NA
Oxychlordane	1200	NG/KG	ND	ND	ND
Trans Nonachlor	250	NG/KG	ND	ND	ND
Cis Nonachlor	380	NG/KG	ND	ND	ND
Alpha Endosulfan	720	NG/KG	ND	ND	ND
Beta Endosulfan	780	NG/KG	ND	ND	ND
Endosulfan Sulfate	1100	NG/KG	ND	ND	ND
Endrin	830	NG/KG	ND	ND	ND
Endrin aldehyde	2400	NG/KG	ND	ND	ND
Mirex	500	NG/KG	ND	ND	ND
Methoxychlor	1100	NG/KG	ND	ND	ND
=====	=====	=====	=====	=====	=====
Aldrin + Dieldrin	430	NG/KG	0	0	0
Hexachlorocyclohexanes	700	NG/KG	0	0	0
DDT and derivatives	830	NG/KG	0	0	0
Chlordane + related cmpds.	1200	NG/KG	0	0	0
=====	=====	=====	=====	=====	=====
Chlorinated Hydrocarbons	2400	NG/KG	0	0	0

ND=not detected  
 NA=not analyzed

Standards for alpha and gamma chlordene are no longer available in the U.S. for the analysis of these compounds.

SOUTH BAY OCEAN OUTFALL MONITORING  
 SEDIMENT ANNUAL - PCB Congeners (I-1 to I-40)

Annual 2013

Source:			I-1	I-2	I-3	I-4	I-6	I-7
Date:			2013	2013	2013	2013	2013	2013
Analyte	MDL	Units	Avg	Avg	Avg	Avg	Avg	Avg
PCB 18	540	NG/KG	ND	<540	ND	ND	ND	ND
PCB 28	660	NG/KG	ND	<660	ND	ND	ND	ND
PCB 52	1000	NG/KG	ND	ND	ND	ND	ND	ND
PCB 49	850	NG/KG	ND	ND	ND	ND	ND	ND
PCB 44	890	NG/KG	ND	ND	ND	ND	ND	ND
PCB 37	340	NG/KG	ND	<340	ND	ND	ND	ND
PCB 74	900	NG/KG	ND	<900	ND	ND	ND	ND
PCB 70	1100	NG/KG	ND	<1100	ND	ND	ND	ND
PCB 66	920	NG/KG	ND	<920	ND	ND	ND	ND
PCB 101	430	NG/KG	ND	ND	ND	ND	ND	ND
PCB 99	660	NG/KG	ND	ND	ND	ND	ND	ND
PCB 119	560	NG/KG	ND	ND	ND	ND	ND	ND
PCB 87	600	NG/KG	ND	ND	ND	ND	ND	ND
PCB 110	640	NG/KG	ND	ND	ND	ND	ND	ND
PCB 81	590	NG/KG	ND	ND	ND	ND	ND	ND
PCB 151	640	NG/KG	ND	ND	ND	ND	ND	ND
PCB 77	790	NG/KG	ND	ND	ND	ND	ND	ND
PCB 149	500	NG/KG	ND	ND	ND	ND	ND	ND
PCB 123	660	NG/KG	ND	ND	ND	ND	ND	ND
PCB 118	830	NG/KG	ND	ND	ND	ND	ND	ND
PCB 114	700	NG/KG	ND	ND	ND	ND	ND	ND
PCB 105	720	NG/KG	ND	ND	ND	ND	ND	ND
PCB 138	590	NG/KG	ND	ND	ND	ND	ND	ND
PCB 158	510	NG/KG	ND	ND	ND	ND	ND	ND
PCB 187	470	NG/KG	ND	ND	ND	ND	ND	ND
PCB 183	530	NG/KG	ND	ND	ND	ND	ND	ND
PCB 126	720	NG/KG	ND	ND	ND	ND	ND	ND
PCB 128	570	NG/KG	ND	ND	ND	ND	ND	ND
PCB 167	620	NG/KG	ND	ND	ND	ND	ND	ND
PCB 177	650	NG/KG	ND	ND	ND	ND	ND	ND
PCB 201	530	NG/KG	ND	ND	ND	ND	ND	ND
PCB 156	620	NG/KG	ND	ND	ND	ND	ND	ND
PCB 157	700	NG/KG	ND	ND	ND	ND	ND	ND
PCB 180	530	NG/KG	ND	ND	ND	ND	ND	ND
PCB 170	570	NG/KG	ND	ND	ND	ND	ND	ND
Total PCB's	1100	NG/KG	0	0	0	0	0	0

ND=not detected

SOUTH BAY OCEAN OUTFALL MONITORING  
 SEDIMENT ANNUAL - PCB Congeners (I-1 to I-40)

Annual 2013

Source:			I-8	I-9	I-10	I-12	I-13	I-14
Date:			2013	2013	2013	2013	2013	2013
Analyte	MDL	Units	Avg	Avg	Avg	Avg	Avg	Avg
PCB 18	540	NG/KG	ND	ND	ND	ND	ND	ND
PCB 28	660	NG/KG	ND	ND	ND	ND	ND	ND
PCB 52	1000	NG/KG	ND	ND	ND	ND	ND	ND
PCB 49	850	NG/KG	ND	ND	ND	ND	ND	ND
PCB 44	890	NG/KG	ND	ND	ND	ND	ND	ND
PCB 37	340	NG/KG	ND	ND	ND	ND	ND	ND
PCB 74	900	NG/KG	ND	ND	ND	ND	ND	ND
PCB 70	1100	NG/KG	ND	ND	ND	ND	ND	ND
PCB 66	920	NG/KG	ND	ND	ND	ND	ND	<920
PCB 101	430	NG/KG	ND	ND	ND	ND	ND	ND
PCB 99	660	NG/KG	ND	ND	ND	ND	ND	ND
PCB 119	560	NG/KG	ND	ND	ND	ND	ND	ND
PCB 87	600	NG/KG	ND	ND	ND	ND	ND	ND
PCB 110	640	NG/KG	ND	ND	ND	ND	ND	<640
PCB 81	590	NG/KG	ND	ND	ND	ND	ND	ND
PCB 151	640	NG/KG	ND	ND	ND	ND	ND	ND
PCB 77	790	NG/KG	ND	ND	ND	ND	ND	ND
PCB 149	500	NG/KG	ND	ND	ND	ND	ND	ND
PCB 123	660	NG/KG	ND	ND	ND	ND	ND	ND
PCB 118	830	NG/KG	ND	ND	ND	ND	ND	ND
PCB 114	700	NG/KG	ND	ND	ND	ND	ND	ND
PCB 105	720	NG/KG	ND	ND	ND	ND	ND	ND
PCB 138	590	NG/KG	ND	ND	ND	ND	ND	<590
PCB 158	510	NG/KG	ND	ND	ND	ND	ND	ND
PCB 187	470	NG/KG	ND	ND	ND	ND	ND	ND
PCB 183	530	NG/KG	ND	ND	ND	ND	ND	ND
PCB 126	720	NG/KG	ND	ND	ND	ND	ND	ND
PCB 128	570	NG/KG	ND	ND	ND	ND	ND	ND
PCB 167	620	NG/KG	ND	ND	ND	ND	ND	ND
PCB 177	650	NG/KG	ND	ND	ND	ND	ND	ND
PCB 201	530	NG/KG	ND	ND	ND	ND	ND	ND
PCB 156	620	NG/KG	ND	ND	ND	ND	ND	ND
PCB 157	700	NG/KG	ND	ND	ND	ND	ND	ND
PCB 180	530	NG/KG	ND	ND	ND	ND	ND	ND
PCB 170	570	NG/KG	ND	ND	ND	ND	ND	ND
Total PCB's	1100	NG/KG	0	0	0	0	0	0

ND=not detected

SOUTH BAY OCEAN OUTFALL MONITORING  
 SEDIMENT ANNUAL - PCB Congeners (I-1 to I-40)

Annual 2013

Source:			I-15	I-16	I-18	I-20	I-21	I-22
Date:			2013	2013	2013	2013	2013	2013
Analyte	MDL	Units	Avg	Avg	Avg	Avg	Avg	Avg
PCB 18	540	NG/KG	ND	ND	ND	ND	ND	ND
PCB 28	660	NG/KG	ND	ND	ND	ND	ND	<60
PCB 52	1000	NG/KG	ND	ND	ND	ND	ND	<90
PCB 49	850	NG/KG	ND	ND	ND	ND	ND	<70
PCB 44	890	NG/KG	ND	ND	ND	ND	ND	<100
PCB 37	340	NG/KG	ND	ND	ND	ND	ND	<90
PCB 74	900	NG/KG	ND	ND	ND	ND	ND	<100
PCB 70	1100	NG/KG	ND	ND	ND	ND	ND	<60
PCB 66	920	NG/KG	ND	ND	ND	ND	ND	<100
PCB 101	430	NG/KG	ND	ND	ND	ND	ND	ND
PCB 99	660	NG/KG	ND	ND	ND	ND	ND	ND
PCB 119	560	NG/KG	ND	ND	ND	ND	ND	ND
PCB 87	600	NG/KG	ND	ND	ND	ND	ND	ND
PCB 110	640	NG/KG	ND	ND	ND	ND	ND	ND
PCB 81	590	NG/KG	ND	ND	ND	ND	ND	ND
PCB 151	640	NG/KG	ND	ND	ND	ND	ND	ND
PCB 77	790	NG/KG	ND	ND	ND	ND	ND	ND
PCB 149	500	NG/KG	ND	ND	ND	ND	ND	ND
PCB 123	660	NG/KG	ND	ND	ND	ND	ND	ND
PCB 118	830	NG/KG	ND	ND	ND	ND	ND	ND
PCB 114	700	NG/KG	ND	ND	ND	ND	ND	ND
PCB 105	720	NG/KG	ND	ND	ND	ND	ND	ND
PCB 138	590	NG/KG	ND	ND	ND	ND	ND	ND
PCB 158	510	NG/KG	ND	ND	ND	ND	ND	ND
PCB 187	470	NG/KG	ND	ND	ND	ND	ND	ND
PCB 183	530	NG/KG	ND	ND	ND	ND	ND	ND
PCB 126	720	NG/KG	ND	ND	ND	ND	ND	ND
PCB 128	570	NG/KG	ND	ND	ND	ND	ND	ND
PCB 167	620	NG/KG	ND	ND	ND	ND	ND	ND
PCB 177	650	NG/KG	ND	ND	ND	ND	ND	ND
PCB 201	530	NG/KG	ND	ND	ND	ND	ND	ND
PCB 156	620	NG/KG	ND	ND	ND	ND	ND	ND
PCB 157	700	NG/KG	ND	ND	ND	ND	ND	ND
PCB 180	530	NG/KG	ND	ND	ND	ND	ND	ND
PCB 170	570	NG/KG	ND	ND	ND	ND	ND	ND
Total PCB's	1100	NG/KG	0	0	0	0	0	0

ND=not detected

SOUTH BAY OCEAN OUTFALL MONITORING  
 SEDIMENT ANNUAL - PCB Congeners (I-1 to I-40)

Annual 2013

Source:			I-23	I-27	I-28	I-29	I-30	I-31
Date:			2013	2013	2013	2013	2013	2013
Analyte	MDL	Units	Avg	Avg	Avg	Avg	Avg	Avg
PCB 18	540	NG/KG	ND	ND	ND	ND	ND	ND
PCB 28	660	NG/KG	ND	ND	ND	ND	ND	ND
PCB 52	1000	NG/KG	ND	ND	ND	ND	ND	ND
PCB 49	850	NG/KG	ND	ND	ND	ND	ND	ND
PCB 44	890	NG/KG	ND	ND	ND	ND	ND	ND
PCB 37	340	NG/KG	ND	ND	ND	ND	ND	ND
PCB 74	900	NG/KG	ND	ND	ND	ND	ND	ND
PCB 70	1100	NG/KG	ND	ND	<1100	ND	ND	ND
PCB 66	920	NG/KG	ND	ND	<920	ND	ND	ND
PCB 101	430	NG/KG	ND	ND	<430	ND	ND	ND
PCB 99	660	NG/KG	ND	ND	ND	ND	ND	ND
PCB 119	560	NG/KG	ND	ND	ND	ND	ND	ND
PCB 87	600	NG/KG	ND	ND	ND	ND	ND	ND
PCB 110	640	NG/KG	ND	ND	<640	ND	ND	ND
PCB 81	590	NG/KG	ND	ND	ND	ND	ND	ND
PCB 151	640	NG/KG	ND	ND	ND	ND	ND	ND
PCB 77	790	NG/KG	ND	ND	ND	ND	ND	ND
PCB 149	500	NG/KG	ND	ND	<500	ND	ND	ND
PCB 123	660	NG/KG	ND	ND	ND	ND	ND	ND
PCB 118	830	NG/KG	ND	ND	ND	ND	ND	ND
PCB 114	700	NG/KG	ND	ND	ND	ND	ND	ND
PCB 105	720	NG/KG	ND	ND	ND	ND	ND	ND
PCB 138	590	NG/KG	ND	ND	E160	ND	ND	ND
PCB 158	510	NG/KG	ND	ND	ND	ND	ND	ND
PCB 187	470	NG/KG	ND	ND	ND	ND	ND	ND
PCB 183	530	NG/KG	ND	ND	ND	ND	ND	ND
PCB 126	720	NG/KG	ND	ND	ND	ND	ND	ND
PCB 128	570	NG/KG	ND	ND	ND	ND	ND	ND
PCB 167	620	NG/KG	ND	ND	ND	ND	ND	ND
PCB 177	650	NG/KG	ND	ND	ND	ND	ND	ND
PCB 201	530	NG/KG	ND	ND	ND	ND	ND	ND
PCB 156	620	NG/KG	ND	ND	ND	ND	ND	ND
PCB 157	700	NG/KG	ND	ND	ND	ND	ND	ND
PCB 180	530	NG/KG	ND	ND	<530	ND	ND	ND
PCB 170	570	NG/KG	ND	ND	ND	ND	ND	ND
Total PCB's	1100	NG/KG	0	0	0	0	0	0

ND=not detected

E=estimated value, value is less than the Method Detection Limit but confirmed by GC/MS-MS.



SOUTH BAY OCEAN OUTFALL MONITORING  
 SEDIMENT ANNUAL - PCB Congeners (I-1 to I-40)

Annual 2013

Source:			I-33	I-34	I-35
Date:			2013	2013	2013
Analyte	MDL	Units	Avg	Avg	Avg
PCB 18	540	NG/KG	ND	ND	ND
PCB 28	660	NG/KG	ND	ND	ND
PCB 52	1000	NG/KG	ND	ND	ND
PCB 49	850	NG/KG	ND	ND	ND
PCB 44	890	NG/KG	ND	ND	ND
PCB 37	340	NG/KG	ND	ND	ND
PCB 74	900	NG/KG	ND	ND	ND
PCB 70	1100	NG/KG	ND	ND	ND
PCB 66	920	NG/KG	ND	ND	ND
PCB 101	430	NG/KG	ND	ND	ND
PCB 99	660	NG/KG	ND	ND	ND
PCB 119	560	NG/KG	ND	ND	ND
PCB 87	600	NG/KG	ND	ND	ND
PCB 110	640	NG/KG	ND	ND	ND
PCB 81	590	NG/KG	ND	ND	ND
PCB 151	640	NG/KG	ND	ND	ND
PCB 77	790	NG/KG	ND	ND	ND
PCB 149	500	NG/KG	ND	ND	ND
PCB 123	660	NG/KG	ND	ND	ND
PCB 118	830	NG/KG	ND	ND	ND
PCB 114	700	NG/KG	ND	ND	ND
PCB 105	720	NG/KG	ND	ND	ND
PCB 138	590	NG/KG	ND	ND	ND
PCB 158	510	NG/KG	ND	ND	ND
PCB 187	470	NG/KG	ND	ND	ND
PCB 183	530	NG/KG	ND	ND	ND
PCB 126	720	NG/KG	ND	ND	ND
PCB 128	570	NG/KG	ND	ND	ND
PCB 167	620	NG/KG	ND	ND	ND
PCB 177	650	NG/KG	ND	ND	ND
PCB 201	530	NG/KG	ND	ND	ND
PCB 156	620	NG/KG	ND	ND	ND
PCB 157	700	NG/KG	ND	ND	ND
PCB 180	530	NG/KG	ND	ND	ND
PCB 170	570	NG/KG	ND	ND	ND
Total PCB's	1100	NG/KG	0	0	0

ND=not detected

SOUTH BAY OCEAN OUTFALL MONITORING  
SEDIMENT ANNUAL Base/Neutrals - International Stations

Annual 2013

Source:		I-1	I-2	I-3	I-4	I-6	I-7	I-8
Date:		2013	2013	2013	2013	2013	2013	2013
Analyte	MDL Units	Avg	Avg	Avg	Avg	Avg	Avg	Avg
Acenaphthene	20 UG/KG	ND	ND	ND	ND	ND	ND	ND
Acenaphthylene	30 UG/KG	ND	ND	ND	ND	ND	ND	ND
Anthracene	20 UG/KG	ND	ND	ND	ND	ND	ND	ND
Benzo[a]anthracene	20 UG/KG	ND	ND	ND	ND	ND	ND	ND
Benzo[a]pyrene	20 UG/KG	ND	ND	ND	ND	ND	ND	ND
3,4-Benzo(b)fluoranthene	20 UG/KG	ND	ND	ND	ND	ND	ND	ND
Benzo[e]pyrene	20 UG/KG	ND	ND	ND	ND	ND	ND	ND
Benzo[g,h,i]perylene	20 UG/KG	ND	ND	ND	ND	ND	ND	ND
Benzo[k]fluoranthene	20 UG/KG	ND	ND	ND	ND	ND	ND	ND
Biphenyl	30 UG/KG	ND	ND	ND	ND	ND	ND	ND
Chrysene	40 UG/KG	ND	ND	ND	ND	ND	ND	ND
Dibenzo(a,h)anthracene	20 UG/KG	ND	ND	ND	ND	ND	ND	ND
2,6-Dimethylnaphthalene	20 UG/KG	ND	ND	ND	ND	ND	ND	ND
Fluoranthene	20 UG/KG	ND	ND	ND	ND	ND	ND	ND
Fluorene	20 UG/KG	ND	ND	ND	ND	ND	ND	ND
Indeno(1,2,3-CD)pyrene	20 UG/KG	ND	ND	ND	ND	ND	ND	ND
1-Methylphenanthrene	20 UG/KG	ND	ND	ND	ND	ND	ND	ND
2-Methylnaphthalene	20 UG/KG	ND	ND	ND	ND	ND	ND	ND
1-Methylnaphthalene	20 UG/KG	ND	ND	ND	ND	ND	ND	ND
Naphthalene	30 UG/KG	ND	ND	ND	ND	ND	ND	ND
Perylene	30 UG/KG	ND	ND	ND	ND	ND	ND	ND
Phenanthrene	30 UG/KG	ND	ND	ND	ND	ND	ND	ND
Pyrene	20 UG/KG	ND	ND	ND	ND	ND	ND	ND
2,3,5-Trimethylnaphthalene	20 UG/KG	ND	ND	ND	ND	ND	ND	ND
Base/Neutral Compounds		0	0	0	0	0	0	0

Source:		I-9	I-10	I-12	I-13	I-14	I-15	I-16
Date:		2013	2013	2013	2013	2013	2013	2013
Analyte	MDL Units	Avg	Avg	Avg	Avg	Avg	Avg	Avg
Acenaphthene	20 UG/KG	ND	ND	ND	ND	ND	ND	ND
Acenaphthylene	30 UG/KG	ND	ND	ND	ND	ND	ND	ND
Anthracene	20 UG/KG	ND	ND	ND	ND	ND	ND	ND
Benzo[a]anthracene	20 UG/KG	ND	ND	ND	ND	ND	ND	ND
Benzo[a]pyrene	20 UG/KG	ND	ND	ND	ND	ND	ND	ND
3,4-Benzo(b)fluoranthene	20 UG/KG	ND	ND	ND	ND	ND	ND	ND
Benzo[e]pyrene	20 UG/KG	ND	ND	ND	ND	ND	ND	ND
Benzo[g,h,i]perylene	20 UG/KG	ND	ND	ND	ND	ND	ND	ND
Benzo[k]fluoranthene	20 UG/KG	ND	ND	ND	ND	ND	ND	ND
Biphenyl	30 UG/KG	ND	ND	ND	ND	ND	ND	ND
Chrysene	40 UG/KG	ND	ND	ND	ND	ND	ND	ND
Dibenzo(a,h)anthracene	20 UG/KG	ND	ND	ND	ND	ND	ND	ND
2,6-Dimethylnaphthalene	20 UG/KG	ND	ND	ND	ND	ND	ND	<20
Fluoranthene	20 UG/KG	ND	ND	ND	ND	ND	ND	ND
Fluorene	20 UG/KG	ND	ND	ND	ND	ND	ND	ND
Indeno(1,2,3-CD)pyrene	20 UG/KG	ND	ND	ND	ND	ND	ND	ND
1-Methylphenanthrene	20 UG/KG	ND	ND	ND	ND	ND	ND	ND
2-Methylnaphthalene	20 UG/KG	ND	ND	ND	ND	ND	ND	ND
1-Methylnaphthalene	20 UG/KG	ND	ND	ND	ND	ND	ND	ND
Naphthalene	30 UG/KG	ND	ND	ND	ND	ND	ND	ND
Perylene	30 UG/KG	ND	ND	ND	ND	ND	ND	ND
Phenanthrene	30 UG/KG	ND	ND	ND	ND	ND	ND	ND
Pyrene	20 UG/KG	ND	ND	ND	ND	ND	ND	ND
2,3,5-Trimethylnaphthalene	20 UG/KG	ND	ND	ND	ND	ND	ND	ND
Base/Neutral Compounds		0	0	0	0	0	0	0

ND=not detected

SOUTH BAY OCEAN OUTFALL MONITORING  
SEDIMENT ANNUAL Base/Neutrals - International Stations

Annual 2013

Source:		I-18	I-20	I-21	I-22	I-23	I-27	I-28
Date:		2013	2013	2013	2013	2013	2013	2013
Analyte	MDL Units	Avg	Avg	Avg	Avg	Avg	Avg	Avg
Acenaphthene	20 UG/KG	ND	ND	ND	ND	ND	ND	ND
Acenaphthylene	30 UG/KG	ND	ND	ND	ND	ND	ND	ND
Anthracene	20 UG/KG	ND	ND	ND	ND	ND	ND	ND
Benzo[a]anthracene	20 UG/KG	ND	ND	ND	ND	ND	ND	ND
Benzo[a]pyrene	20 UG/KG	ND	ND	ND	ND	ND	ND	ND
3,4-Benzo(b)fluoranthene	20 UG/KG	ND	ND	ND	ND	ND	ND	ND
Benzo[e]pyrene	20 UG/KG	ND	ND	ND	ND	ND	ND	ND
Benzo[g,h,i]perylene	20 UG/KG	ND	ND	ND	ND	ND	ND	ND
Benzo[k]fluoranthene	20 UG/KG	ND	ND	ND	ND	ND	ND	ND
Biphenyl	30 UG/KG	ND	ND	ND	ND	ND	ND	ND
Chrysene	40 UG/KG	ND	ND	ND	ND	ND	ND	ND
Dibenzo(a,h)anthracene	20 UG/KG	ND	ND	ND	ND	ND	ND	ND
2,6-Dimethylnaphthalene	20 UG/KG	ND	ND	ND	ND	ND	ND	<20
Fluoranthene	20 UG/KG	ND	ND	ND	ND	ND	ND	ND
Fluorene	20 UG/KG	ND	ND	ND	ND	ND	ND	ND
Indeno(1,2,3-CD)pyrene	20 UG/KG	ND	ND	ND	ND	ND	ND	ND
1-Methylphenanthrene	20 UG/KG	ND	ND	ND	ND	ND	ND	ND
2-Methylnaphthalene	20 UG/KG	ND	ND	ND	ND	ND	ND	ND
1-Methylnaphthalene	20 UG/KG	ND	ND	ND	ND	ND	ND	ND
Naphthalene	30 UG/KG	ND	ND	ND	ND	ND	ND	ND
Perylene	30 UG/KG	ND	ND	ND	ND	ND	ND	ND
Phenanthrene	30 UG/KG	ND	ND	ND	ND	ND	ND	ND
Pyrene	20 UG/KG	ND	ND	ND	ND	ND	ND	ND
2,3,5-Trimethylnaphthalene	20 UG/KG	ND	ND	ND	ND	ND	ND	ND
Base/Neutral Compounds		0	0	0	0	0	0	0

Source:		I-29	I-30	I-31	I-33	I-34	I-35
Date:		2013	2013	2013	2013	2013	2013
Analyte	MDL Units	Avg	Avg	Avg	Avg	Avg	Avg
Acenaphthene	20 UG/KG	ND	ND	ND	ND	ND	ND
Acenaphthylene	30 UG/KG	ND	ND	ND	ND	ND	ND
Anthracene	20 UG/KG	ND	ND	ND	ND	ND	ND
Benzo[a]anthracene	20 UG/KG	ND	ND	ND	<20	ND	ND
Benzo[a]pyrene	20 UG/KG	<20	ND	ND	<20	ND	ND
3,4-Benzo(b)fluoranthene	20 UG/KG	ND	ND	ND	<20	ND	ND
Benzo[e]pyrene	20 UG/KG	ND	ND	ND	ND	ND	ND
Benzo[g,h,i]perylene	20 UG/KG	ND	ND	ND	ND	ND	ND
Benzo[k]fluoranthene	20 UG/KG	ND	ND	ND	ND	ND	ND
Biphenyl	30 UG/KG	ND	ND	ND	ND	ND	ND
Chrysene	40 UG/KG	ND	ND	ND	<40	ND	ND
Dibenzo(a,h)anthracene	20 UG/KG	ND	ND	ND	ND	ND	ND
2,6-Dimethylnaphthalene	20 UG/KG	<20	ND	ND	ND	ND	<20
Fluoranthene	20 UG/KG	ND	ND	ND	20	ND	ND
Fluorene	20 UG/KG	ND	ND	ND	ND	ND	ND
Indeno(1,2,3-CD)pyrene	20 UG/KG	ND	ND	ND	ND	ND	ND
1-Methylphenanthrene	20 UG/KG	ND	ND	ND	ND	ND	ND
2-Methylnaphthalene	20 UG/KG	ND	ND	ND	ND	ND	ND
1-Methylnaphthalene	20 UG/KG	ND	ND	ND	ND	ND	ND
Naphthalene	30 UG/KG	ND	ND	ND	ND	ND	ND
Perylene	30 UG/KG	ND	ND	ND	ND	ND	ND
Phenanthrene	30 UG/KG	ND	ND	ND	<30	ND	ND
Pyrene	20 UG/KG	<20	ND	ND	<20	ND	ND
2,3,5-Trimethylnaphthalene	20 UG/KG	ND	ND	ND	ND	ND	ND
Base/Neutral Compounds		0	0	0	20	0	0

ND=not detected

B. Fish Tissue Data.

Fish were taken from the following stations during 2013. The fish were dissected, preserved by freezing, and each sample analyzed for PAHs, trace metals, chlorinated pesticides and PCBs. Lipids and total solids were also determined for each sample.

The reported values are annual averages. Results for individual sampling events are contained in the previously published quarterly reports.

Station

RF-3

RF-4

Station

SD-15

SD-16

SD-17

SD-18

SD-19

SD-20

SD-21

# South Bay Rig Fishing and Trawl Stations

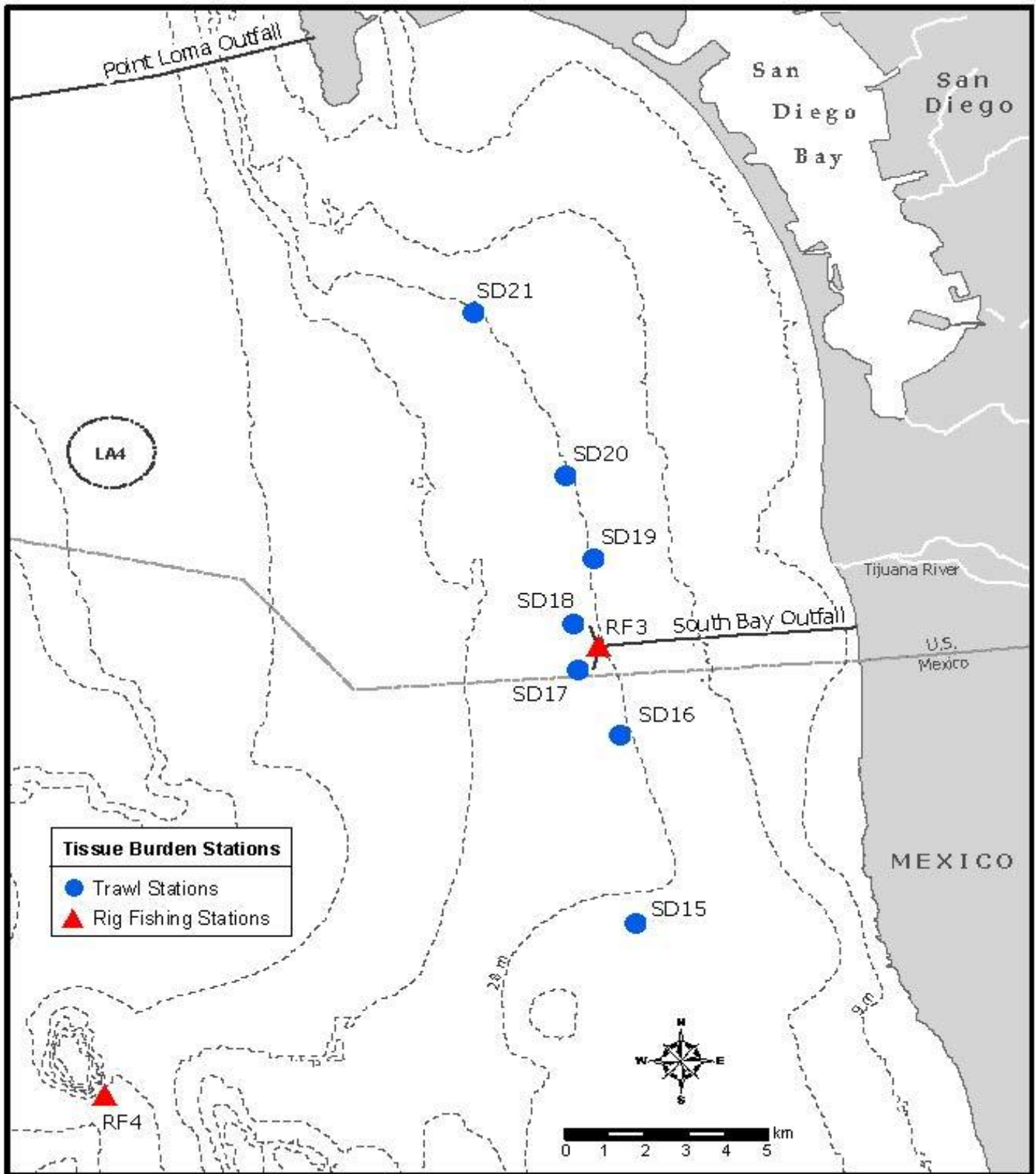

SOUTH BAY WATER RECLAMATION PLANT  
TISSUE

Annual 2013

FISH - Lipids & Total Solids

Source:			SD-15	SD-16	SD-17	SD-18	SD-19	SD-20
Date:			2013	2013	2013	2013	2013	2013
Tissue Analyte	MDL Units		Avg	Avg	Avg	Avg	Avg	Avg
Liver Lipids	.09 WT%		5.4	14.9	9.1	15.7	15.1	18.2
Liver Total Solids	.4 WT%		26.4	34.8	29.2	33.7	38.4	38.1

Source:			SD-21	RF-3	RF-4
Date:			2013	2013	2013
Tissue Analyte	MDL Units		Avg	Avg	Avg
Liver Lipids	.09 WT%		22.5		
Liver Total Solids	.4 WT%		37.2		
Muscle Lipids	.09 WT%			0.8	0.6
Muscle Total Solids	.4 WT%			21.0	21.0

ND= not detected

SOUTH BAY WATER RECLAMATION PLANT  
FISH TISSUE - MUSCLE

Trace Metals

Annual 2013

Source:		RF-3	RF-4
Date:		2013	2013
Analyte	MDL Units	Average	Average
=====	=====	=====	=====
Aluminum	3 MG/KG	<3	3
Antimony	.2 MG/KG	ND	ND
Arsenic	.24 MG/KG	2.69	1.95
Beryllium	.006 MG/KG	ND	ND
Cadmium	.06 MG/KG	ND	ND
Chromium	.1 MG/KG	0.1	0.2
Copper	.3 MG/KG	<0.3	ND
Iron	2 MG/KG	<2	<2
Lead	.2 MG/KG	<0.2	ND
Manganese	.1 MG/KG	<0.1	ND
Nickel	.2 MG/KG	ND	ND
Selenium	.06 MG/KG	0.35	0.32
Silver	.05 MG/KG	ND	ND
Thallium	.4 MG/KG	ND	<0.4
Tin	.2 MG/KG	0.6	0.4
Zinc	.15 MG/KG	3.6	4.5
=====	=====	=====	=====
Total Solids	.4 WT%	21.0	21.0

ND= not detected

SOUTH BAY WATER RECLAMATION PLANT  
FISH TISSUE - LIVER

Trace Metals

Annual 2013

Source:		SD-15	SD-16	SD-17	SD-18	SD-19
Date:		2013	2013	2013	2013	2013
Analyte	MDL Units	Average	Average	Average	Average	Average
=====	====	=====	=====	=====	=====	=====
Aluminum	3 MG/KG	4	3	<3	6	3
Antimony	.2 MG/KG	ND	ND	<0.2	ND	<0.2
Arsenic	.24 MG/KG	14.1	7.64	12.30	8.11	7.08
Beryllium	.006 MG/KG	ND	ND	ND	ND	ND
Cadmium	.06 MG/KG	3.4	3.99	2.63	2.82	4.12
Chromium	.1 MG/KG	0.3	0.3	0.2	0.3	0.3
Copper	.3 MG/KG	6.8	6.8	4.6	6.4	6.9
Iron	2 MG/KG	118	141	147	76	98
Lead	.2 MG/KG	0.3	0.2	0.5	<0.2	0.2
Manganese	.1 MG/KG	1.5	1.4	1.2	1.5	1.6
Nickel	.2 MG/KG	ND	ND	ND	<0.2	ND
Selenium	.06 MG/KG	1.31	1.51	1.56	1.24	1.3
Thallium	.4 MG/KG	ND	ND	ND	<0.4	ND
Tin	.2 MG/KG	0.7	1.0	0.9	1.1	1.3
Zinc	.15 MG/KG	48.3	35.3	43.8	41.8	37.7
Total Solids	.4 WT%	26.4	34.8	29.2	33.7	38.4

Source:		SD-20	SD-21
Date:		2013	2013
Analyte	MDL Units	Average	Average
=====	====	=====	=====
Aluminum	3 MG/KG	4	3
Antimony	.2 MG/KG	<0.2	ND
Arsenic	.24 MG/KG	13.1	4.79
Beryllium	.006 MG/KG	ND	ND
Cadmium	.06 MG/KG	1.77	2.26
Chromium	.1 MG/KG	0.2	0.3
Copper	.3 MG/KG	9.0	6.2
Iron	2 MG/KG	139	58
Lead	.2 MG/KG	0.4	<0.2
Manganese	.1 MG/KG	1.5	1.6
Nickel	.2 MG/KG	<0.2	ND
Selenium	.06 MG/KG	1.67	0.77
Thallium	.4 MG/KG	<0.4	ND
Tin	.2 MG/KG	1.3	1.1
Zinc	.15 MG/KG	32.3	34.6
Total Solids	.4 WT%	38.1	37.2

ND= not detected



SOUTH BAY WATER RECLAMATION PLANT  
FISH LIVER - Chlorinated Pesticides

Annual 2013

Source:			SD-15	SD-16	SD-17	SD-18	SD-19
Date:			2013	2013	2013	2013	2013
Analyte	MDL	Units	Average Value	Average Value	Average Value	Average Value	Average Value
Hexachlorobenzene	2.29	UG/KG	<2.29	<2.29	<2.29	<2.29	<2.29
BHC, Gamma isomer	50.4	UG/KG	ND	ND	ND	ND	ND
Heptachlor	2.1	UG/KG	ND	ND	ND	ND	ND
Aldrin	25.3	UG/KG	ND	ND	ND	ND	ND
Heptachlor epoxide	3.79	UG/KG	ND	ND	ND	ND	ND
o,p-DDE	2.52	UG/KG	<2.52	E2.80	<2.52	<2.52	3.27
Alpha Endosulfan	24.7	UG/KG	ND	ND	ND	ND	ND
Alpha (cis) Chlordane	2.02	UG/KG	ND	ND	ND	ND	ND
Trans Nonachlor	1.44	UG/KG	ND	ND	ND	ND	ND
p,p-DDE	4.94	UG/KG	25.7	175	48.2	133	167
Dieldrin	12.6	UG/KG	ND	ND	ND	ND	ND
o,p-DDD	1.98	UG/KG	ND	ND	ND	ND	ND
Endrin	30.3	UG/KG	ND	ND	ND	ND	ND
o,p-DDT	2.05	UG/KG	ND	ND	ND	ND	ND
p,p-DDD	2.86	UG/KG	ND	<2.86	ND	E2.9	4.7
p,p-DDT	2.76	UG/KG	ND	ND	ND	<2.76	<2.76
Mirex	1.77	UG/KG	ND	ND	ND	ND	ND

Source:			SD-20	SD-21
Date:			2013	2013
Analyte	MDL	Units	Average Value	Average Value
Hexachlorobenzene	2.29	UG/KG	E2.37	E2.4
BHC, Gamma isomer	50.4	UG/KG	ND	ND
Heptachlor	2.1	UG/KG	ND	ND
Aldrin	25.3	UG/KG	ND	ND
Heptachlor epoxide	3.79	UG/KG	ND	ND
o,p-DDE	2.52	UG/KG	4.98	5.2
Alpha Endosulfan	24.7	UG/KG	ND	ND
Alpha (cis) Chlordane	2.02	UG/KG	ND	ND
Trans Nonachlor	1.44	UG/KG	ND	<1.44
p,p-DDE	4.94	UG/KG	225	247
Dieldrin	12.6	UG/KG	ND	ND
o,p-DDD	1.98	UG/KG	<1.98	ND
Endrin	30.3	UG/KG	ND	ND
o,p-DDT	2.05	UG/KG	ND	ND
p,p-DDD	2.86	UG/KG	6.85	6.47
p,p-DDT	2.76	UG/KG	<2.76	<2.76
Mirex	1.77	UG/KG	ND	ND

ND= not detected

E=estimated value, value is less than the Method Detection Limit but confirmed by GC/MS-MS.

SOUTH BAY WATER RECLAMATION PLANT  
FISH MUSCLE - Chlorinated Pesticides

Annual 2013

Source:			RF-3	RF-4
Date:			2013	2013
Analyte	MDL	Units	Avg	Avg
=====	====	=====	=====	=====
Hexachlorobenzene	.23	UG/KG	<0.23	<0.23
BHC, Gamma isomer	5.04	UG/KG	ND	ND
Heptachlor	.21	UG/KG	ND	ND
Aldrin	2.53	UG/KG	ND	ND
Heptachlor epoxide	.38	UG/KG	ND	ND
o,p-DDE	.25	UG/KG	ND	ND
Alpha Endosulfan	2.47	UG/KG	ND	ND
Alpha (cis) Chlordane	.2	UG/KG	ND	ND
Trans Nonachlor	.14	UG/KG	ND	ND
p,p-DDE	.49	UG/KG	4.43	3.33
Dieldrin	1.26	UG/KG	ND	ND
o,p-DDD	.2	UG/KG	ND	ND
Endrin	3.03	UG/KG	ND	ND
o,p-DDT	.2	UG/KG	ND	ND
p,p-DDD	.29	UG/KG	<0.29	ND
p,p-DDT	.28	UG/KG	ND	ND
Mirex	.18	UG/KG	ND	ND

ND= not detected

SOUTH BAY WATER RECLAMATION PLANT  
FISH LIVER - Analysis of Poly Aromatic Hydrocarbon (PAH)

Annual 2013

Source:			SD-15	SD-16	SD-17	SD-18
Date:			2013	2013	2013	2013
Analyte	MDL	Units	Avg	Avg	Avg	Avg
Acenaphthene	28.9	UG/KG	ND	ND	ND	ND
Acenaphthylene	24.7	UG/KG	ND	ND	ND	ND
Anthracene	25.3	UG/KG	ND	ND	ND	ND
Benzo[a]anthracene	47.3	UG/KG	ND	ND	ND	ND
Benzo[a]pyrene	42.9	UG/KG	ND	ND	ND	ND
3,4-Benzo(b)fluoranthene	30.2	UG/KG	ND	ND	ND	ND
Benzo[e]pyrene	41.8	UG/KG	ND	ND	ND	ND
Benzo[g,h,i]perylene	27.2	UG/KG	ND	ND	ND	ND
Benzo[k]fluoranthene	32	UG/KG	ND	ND	ND	ND
Biphenyl	38	UG/KG	ND	ND	ND	ND
Chrysene	18.1	UG/KG	ND	ND	ND	ND
Dibenzo(a,h)anthracene	37.6	UG/KG	ND	ND	ND	ND
2,6-Dimethylnaphthalene	21.7	UG/KG	ND	ND	ND	<21.7
Fluoranthene	19.9	UG/KG	ND	ND	ND	<19.9
Fluorene	27.3	UG/KG	ND	ND	ND	ND
Indeno(1,2,3-CD)pyrene	25.6	UG/KG	ND	ND	ND	ND
1-Methylnaphthalene	27.9	UG/KG	ND	ND	ND	ND
2-Methylnaphthalene	35.8	UG/KG	ND	ND	ND	ND
1-Methylphenanthrene	17.4	UG/KG	ND	ND	ND	<17.4
Naphthalene	34.2	UG/KG	ND	ND	ND	ND
Perylene	18.5	UG/KG	ND	ND	ND	ND
Phenanthrene	11.6	UG/KG	ND	ND	ND	ND
Pyrene	9.1	UG/KG	ND	ND	ND	<9.1
2,3,5-Trimethylnaphthalene	21.7	UG/KG	ND	ND	ND	ND

Source:			SD-19	SD-20	SD-21
Date:			2013	2013	2013
Analyte	MDL	Units	Avg	Avg	Avg
Acenaphthene	28.9	UG/KG	ND	ND	ND
Acenaphthylene	24.7	UG/KG	ND	ND	ND
Anthracene	25.3	UG/KG	ND	ND	ND
Benzo[a]anthracene	47.3	UG/KG	ND	ND	ND
Benzo[a]pyrene	42.9	UG/KG	ND	ND	ND
3,4-Benzo(b)fluoranthene	30.2	UG/KG	ND	ND	ND
Benzo[e]pyrene	41.8	UG/KG	ND	ND	ND
Benzo[g,h,i]perylene	27.2	UG/KG	ND	ND	ND
Benzo[k]fluoranthene	32	UG/KG	ND	ND	ND
Biphenyl	38	UG/KG	ND	ND	ND
Chrysene	18.1	UG/KG	ND	ND	ND
Dibenzo(a,h)anthracene	37.6	UG/KG	ND	ND	ND
2,6-Dimethylnaphthalene	21.7	UG/KG	ND	ND	ND
Fluoranthene	19.9	UG/KG	<19.9	ND	ND
Fluorene	27.3	UG/KG	ND	ND	ND
Indeno(1,2,3-CD)pyrene	25.6	UG/KG	ND	ND	ND
1-Methylnaphthalene	27.9	UG/KG	ND	ND	ND
2-Methylnaphthalene	35.8	UG/KG	ND	ND	ND
1-Methylphenanthrene	17.4	UG/KG	<17.4	ND	ND
Naphthalene	34.2	UG/KG	ND	ND	ND
Perylene	18.5	UG/KG	ND	ND	ND
Phenanthrene	11.6	UG/KG	ND	<11.6	ND
Pyrene	9.1	UG/KG	ND	ND	ND
2,3,5-Trimethylnaphthalene	21.7	UG/KG	ND	ND	ND

ND= not detected

SOUTH BAY WATER RECLAMATION PLANT  
FISH MUSCLE - Analysis of Poly Aromatic Hydrocarbon (PAH)

Annual 2013

Source:			RF-3	RF-4
Date:			2013	2013
Analyte	MDL	Units	Avg	Avg
=====	====	====	=====	=====
Acenaphthene	11.3	UG/KG	ND	ND
Acenaphthylene	9.1	UG/KG	ND	ND
Anthracene	8.4	UG/KG	ND	ND
Benzo[a]anthracene	15.9	UG/KG	ND	ND
Benzo[a]pyrene	18.3	UG/KG	ND	ND
3,4-Benzo(b)fluoranthene	26.8	UG/KG	ND	ND
Benzo[e]pyrene	40.6	UG/KG	ND	ND
Benzo[g,h,i]perylene	59.5	UG/KG	ND	ND
Benzo[k]fluoranthene	37.3	UG/KG	ND	ND
Biphenyl	19.9	UG/KG	ND	ND
Chrysene	23	UG/KG	ND	ND
Dibenzo(a,h)anthracene	40.3	UG/KG	ND	ND
2,6-Dimethylnaphthalene	19.5	UG/KG	ND	ND
Fluoranthene	12.9	UG/KG	ND	ND
Fluorene	11.4	UG/KG	ND	ND
Indeno(1,2,3-CD)pyrene	46.5	UG/KG	ND	ND
1-Methylnaphthalene	26.4	UG/KG	ND	ND
2-Methylnaphthalene	13.2	UG/KG	ND	ND
1-Methylphenanthrene	23.3	UG/KG	ND	ND
Naphthalene	17.4	UG/KG	ND	ND
Perylene	50.9	UG/KG	ND	ND
Phenanthrene	12.9	UG/KG	ND	ND
Pyrene	16.6	UG/KG	ND	ND
2,3,5-Trimethylnaphthalene	21.6	UG/KG	ND	ND

ND= not detected

SOUTH BAY WATER RECLAMATION PLANT  
FISH LIVER - Analysis of Poly Chlorinated Biphenyls

Annual 2013

Source:		SD-15	SD-16	SD-17	SD-18	SD-19	SD-20	SD-21
Date:		2013	2013	2013	2013	2013	2013	2013
Analyte	MDL Units	avg	avg	avg	avg	avg	avg	avg
PCB 18	1.49 UG/KG	ND	ND	ND	ND	ND	ND	ND
PCB 28	1.47 UG/KG	ND	ND	ND	<1.47	<1.47	<1.47	<1.47
PCB 49	1.67 UG/KG	<1.67	<1.67	<1.67	<1.67	<1.67	<1.67	<1.67
PCB 37	2.03 UG/KG	ND	ND	ND	ND	ND	ND	ND
PCB 70	2.05 UG/KG	<2.05	<2.05	<2.05	<2.05	<2.05	E1.09	<2.05
PCB 101	1.7 UG/KG	<1.70	4.47	3.55	4.93	3.02	5.24	6.78
PCB 119	2.72 UG/KG	ND	ND	ND	ND	ND	ND	ND
PCB 87	1.95 UG/KG	ND	ND	ND	ND	ND	<1.95	ND
PCB 110	2.13 UG/KG	<2.13	<2.13	<2.13	<2.13	<2.13	E2.83	E3.30
PCB 151	1.52 UG/KG	<1.52	2.25	<1.52	<1.52	<1.52	2.29	2.05
PCB 77	3.32 UG/KG	ND	ND	ND	ND	ND	ND	ND
PCB 149	1.92 UG/KG	E2.15	3.68	E3.57	E4.18	E2.75	5.73	6.21
PCB 123	3.04 UG/KG	ND	ND	ND	ND	ND	ND	<3.04
PCB 118	2.56 UG/KG	<2.56	7.38	E5.08	E6.48	4.45	8.47	18.9
PCB 114	2.77 UG/KG	ND	ND	ND	ND	ND	ND	ND
PCB 153/168	3.76 UG/KG	E7.27	E25.7	E18.6	21.6	15.8	21.7	63.3
PCB 105	2.28 UG/KG	ND	<2.28	ND	<2.28	<2.28	<2.28	3.10
PCB 138	1.93 UG/KG	E3.57	11.7	E8.73	11.5	7.75	10.7	29.6
PCB 158	2.55 UG/KG	ND	<2.55	<2.55	<2.55	<2.55	<2.55	<2.55
PCB 187	2.25 UG/KG	E3.77	E11.9	E7.38	9.18	E6.23	9.65	18.3
PCB 183	2.06 UG/KG	ND	E2.85	<2.06	E2.32	<2.06	E2.28	E5.02
PCB 126	1.93 UG/KG	ND	ND	ND	ND	ND	ND	ND
PCB 128	2.28 UG/KG	ND	<2.28	<2.28	<2.28	<2.28	<2.28	4.08
PCB 167	2.05 UG/KG	ND	<2.05	ND	<2.05	<2.05	<2.05	<2.05
PCB 177	1.96 UG/KG	ND	ND	<1.96	<1.96	<1.96	<1.96	2.32
PCB 156	2.33 UG/KG	ND	ND	ND	ND	ND	ND	<2.33
PCB 157	2.77 UG/KG	ND	ND	ND	ND	ND	ND	ND
PCB 180	2.89 UG/KG	<2.89	9.48	E6.61	E8.72	E5.85	7.41	E15.3
PCB 170	2.16 UG/KG	ND	2.82	<2.16	E2.28	<2.16	<2.16	4.78
PCB 169	1.41 UG/KG	ND	ND	ND	ND	ND	ND	ND
PCB 189	1.78 UG/KG	ND	ND	ND	ND	ND	ND	ND
PCB 194	3.41 UG/KG	ND	<3.41	ND	<3.41	ND	<3.41	3.6
PCB 206	1.84 UG/KG	ND	<1.84	<1.84	<1.84	<1.84	<1.84	2.9

ND= not detected

E=estimated value, value is less than the Method Detection Limit but confirmed by GC/MS-MS.

SOUTH BAY WATER RECLAMATION PLANT  
FISH MUSCLE - Analysis of Poly Chlorinated Biphenyls

Annual 2013

Source:		RF-3	RF-4
Date:		2013	2013
Analyte	MDL Units	Avg	Avg
=====	====	=====	=====
PCB 18	.15 UG/KG	ND	ND
PCB 28	.15 UG/KG	ND	ND
PCB 49	.17 UG/KG	<0.17	ND
PCB 37	.2 UG/KG	ND	ND
PCB 70	.2 UG/KG	<0.20	ND
PCB 101	.17 UG/KG	<0.17	<0.17
PCB 119	.27 UG/KG	ND	ND
PCB 87	.19 UG/KG	ND	ND
PCB 110	.21 UG/KG	<0.21	ND
PCB 151	.15 UG/KG	ND	ND
PCB 77	.33 UG/KG	ND	ND
PCB 149	.19 UG/KG	<0.19	<0.19
PCB 123	.3 UG/KG	ND	ND
PCB 118	.26 UG/KG	<0.26	<0.26
PCB 114	.28 UG/KG	ND	ND
PCB 153/168	.38 UG/KG	E0.38	<0.38
PCB 105	.23 UG/KG	ND	ND
PCB 138	.19 UG/KG	<0.19	<0.19
PCB 158	.26 UG/KG	ND	ND
PCB 187	.23 UG/KG	<0.23	<0.23
PCB 183	.21 UG/KG	<0.21	ND
PCB 126	.19 UG/KG	ND	ND
PCB 128	.23 UG/KG	<0.23	ND
PCB 167	.21 UG/KG	ND	ND
PCB 177	.2 UG/KG	ND	ND
PCB 156	.23 UG/KG	ND	ND
PCB 157	.28 UG/KG	ND	ND
PCB 180	.29 UG/KG	<0.29	<0.29
PCB 170	.22 UG/KG	<0.22	ND
PCB 169	.14 UG/KG	ND	ND
PCB 189	.18 UG/KG	ND	ND
PCB 194	.34 UG/KG	ND	ND
PCB 206	.18 UG/KG	<0.18	<0.18

ND= not detected

E=estimated value, value is less than the Method Detection Limit but confirmed by GC/MS-MS.

### C. Seawater Data

Seawater is collected monthly at the following stations for analysis of total suspended solids (TSS) and Oil & Grease (O&G). Samples for TSS analysis are collected at 3 depths, sub-surface, mid-depth, and bottom, for each station shown in the following table. Oil and Grease samples are only collected from the 5 foot depth. The Oil & Grease analysis was changed to a Hexane Extractable Material (HEM) method. A report of analyses for each month is attached.

**Table 1. Regular Fixed Grid Seawater sampling stations.**

Station	Station
I-3	I-21
I-5	I-22
I-7	I-23
I-8	I-24
I-9	I-25
I-10	I-26
I-11	I-30
I-12	I-32
I-13	I-33
I-14	I-36
I-16	I-37
I-18	I-38
I-19	I-39
I-20	I-40

# Regular Fixed Grid Monitoring Stations

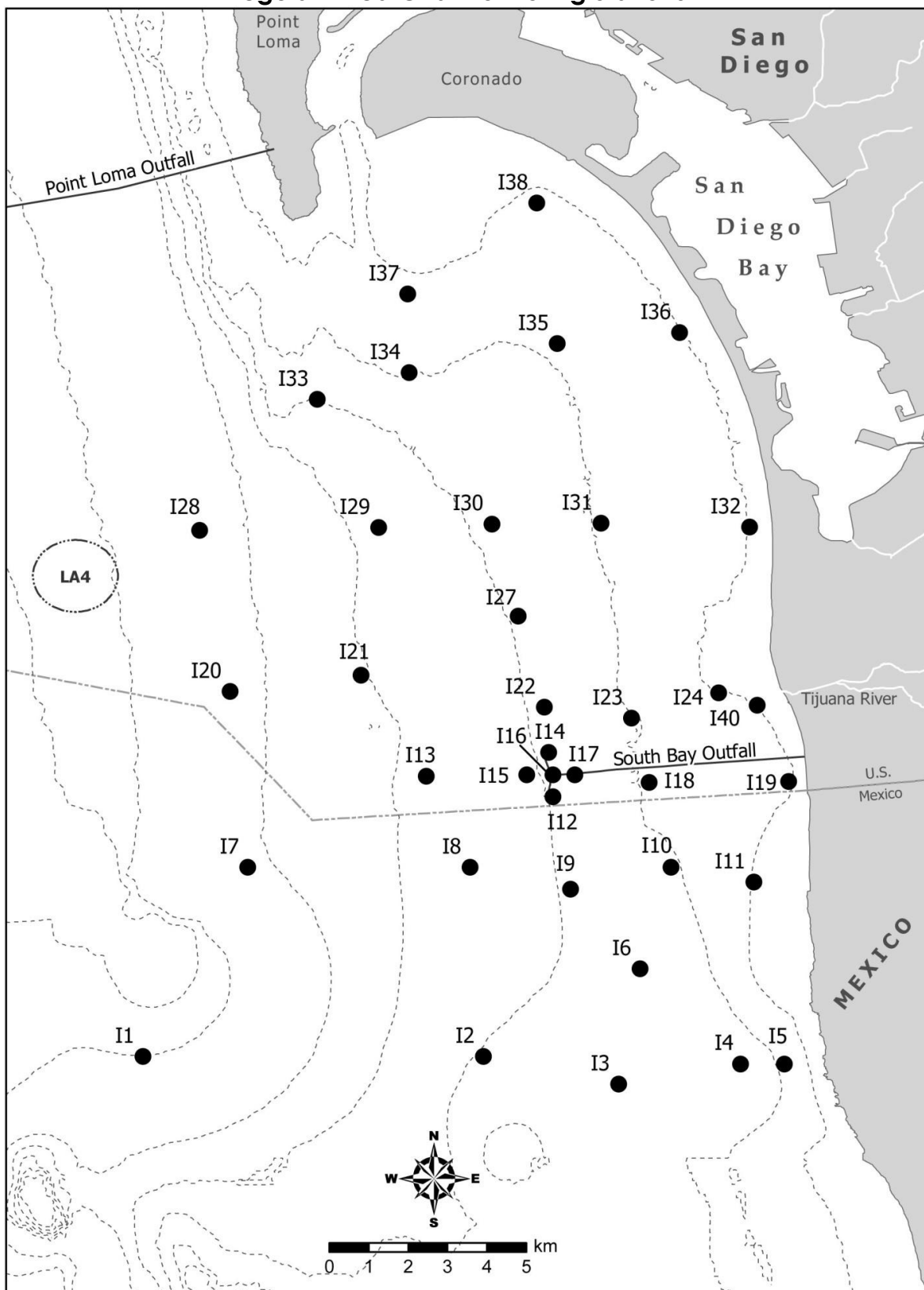

South Bay Ocean Outfall Monitoring  
Seawater Analysis for Total Suspended Solids and Hexane Extractable Material

From 01-JAN-2013 to 31-DEC-2013



Analyte:			HEM	TSS	
MDL:			1.4	1.4	
SOURCE		SAMPLE DATE	mg/L	mg/L	
=====		=====	=====	=====	
I-3	2	M	14-JAN-2013	ND	2.0
I-3	2	M	07-FEB-2013	ND	1.7
I-3	2	M	07-MAR-2013	ND	3.1
I-3	2	M	05-APR-2013	ND	4.4
I-3	2	M	08-MAY-2013	ND	2.1
I-3	2	M	06-JUN-2013	ND	2.3
I-3	2	M	11-JUL-2013	ND	3.2
I-3	2	M	20-AUG-2013	1.90	15.0
I-3	2	M	04-SEP-2013	ND	3.7
I-3	2	M	02-OCT-2013	ND	7.0
I-3	2	M	06-NOV-2013	ND	3.0
I-3	2	M	06-DEC-2013	ND	3.5
I-3	18	M	14-JAN-2013		1.6
I-3	18	M	07-FEB-2013		1.7
I-3	18	M	07-MAR-2013		3.0
I-3	18	M	05-APR-2013		1.9
I-3	18	M	08-MAY-2013		3.4
I-3	18	M	06-JUN-2013		2.5
I-3	18	M	11-JUL-2013		1.9
I-3	18	M	20-AUG-2013		1.9
I-3	18	M	04-SEP-2013		2.2
I-3	18	M	02-OCT-2013		3.1
I-3	18	M	06-NOV-2013		2.2
I-3	18	M	06-DEC-2013		4.1
I-3	27	M	14-JAN-2013		1.9
I-3	27	M	07-FEB-2013		ND
I-3	27	M	07-MAR-2013		4.8
I-3	27	M	05-APR-2013		3.6
I-3	27	M	08-MAY-2013		1.7
I-3	27	M	06-JUN-2013		2.0
I-3	27	M	11-JUL-2013		3.3
I-3	27	M	20-AUG-2013		2.3
I-3	27	M	04-SEP-2013		1.5
I-3	27	M	02-OCT-2013		4.3
I-3	27	M	06-NOV-2013		2.5
I-3	27	M	06-DEC-2013		3.2
I-5	2	M	14-JAN-2013	ND	4.6
I-5	2	M	07-FEB-2013	ND	5.2
I-5	2	M	07-MAR-2013	ND	2.9
I-5	2	M	05-APR-2013	ND	11.6
I-5	2	M	08-MAY-2013	ND	2.3
I-5	2	M	06-JUN-2013	ND	2.2
I-5	2	M	11-JUL-2013	ND	2.2
I-5	2	M	20-AUG-2013	3.40	5.9
I-5	2	M	04-SEP-2013	2.20	23.4
I-5	2	M	02-OCT-2013	ND	7.8
I-5	2	M	06-NOV-2013	ND	4.2
I-5	2	M	06-DEC-2013	ND	5.9
I-5	6	M	14-JAN-2013		4.1
I-5	6	M	07-FEB-2013		2.0
I-5	6	M	07-MAR-2013		4.0
I-5	6	M	05-APR-2013		5.4
I-5	6	M	08-MAY-2013		ND
I-5	6	M	06-JUN-2013		3.5
I-5	6	M	11-JUL-2013		2.1
I-5	6	M	20-AUG-2013		4.7

ND=not detected

South Bay Ocean Outfall Monitoring  
Seawater Analysis for Total Suspended Solids and Hexane Extractable Material

From 01-JAN-2013 to 31-DEC-2013

Analyte:		HEM	TSS
MDL:		1.4	1.4
SOURCE	SAMPLE DATE	mg/L	mg/L
=====	=====	=====	=====
I-5 6 M	04-SEP-2013		3.9
I-5 6 M	02-OCT-2013		8.1
I-5 6 M	06-NOV-2013		5.4
I-5 6 M	06-DEC-2013		4.8
I-5 11 M	14-JAN-2013		4.1
I-5 11 M	07-FEB-2013		2.1
I-5 11 M	07-MAR-2013		8.5
I-5 11 M	05-APR-2013		1.5
I-5 11 M	08-MAY-2013		2.3
I-5 11 M	06-JUN-2013		3.6
I-5 11 M	11-JUL-2013		2.1
I-5 11 M	20-AUG-2013		3.0
I-5 11 M	04-SEP-2013		5.1
I-5 11 M	02-OCT-2013		4.1
I-5 11 M	06-NOV-2013		5.6
I-5 11 M	06-DEC-2013		5.7
I-7 2 M	14-JAN-2013	ND	2.1
I-7 2 M	07-FEB-2013	ND	ND
I-7 2 M	07-MAR-2013	ND	2.9
I-7 2 M	05-APR-2013	ND	3.9
I-7 2 M	08-MAY-2013	ND	2.3
I-7 2 M	06-JUN-2013	ND	2.4
I-7 2 M	11-JUL-2013	ND	1.9
I-7 2 M	20-AUG-2013	ND	<1.4
I-7 2 M	04-SEP-2013	ND	<1.4
I-7 2 M	02-OCT-2013	ND	4.5
I-7 2 M	06-NOV-2013	ND	2.0
I-7 2 M	06-DEC-2013	ND	2.2
I-7 18 M	14-JAN-2013		1.8
I-7 18 M	07-FEB-2013		ND
I-7 18 M	07-MAR-2013		2.0
I-7 18 M	05-APR-2013		3.4
I-7 18 M	08-MAY-2013		3.7
I-7 18 M	06-JUN-2013		3.3
I-7 18 M	11-JUL-2013		3.0
I-7 18 M	20-AUG-2013		1.4
I-7 18 M	04-SEP-2013		3.5
I-7 18 M	02-OCT-2013		2.9
I-7 18 M	06-NOV-2013		2.0
I-7 18 M	06-DEC-2013		2.6
I-7 52 M	14-JAN-2013		2.2
I-7 52 M	07-FEB-2013		ND
I-7 52 M	07-MAR-2013		1.8
I-7 52 M	05-APR-2013		ND
I-7 52 M	08-MAY-2013		2.2
I-7 52 M	06-JUN-2013		ND
I-7 52 M	11-JUL-2013		3.8
I-7 52 M	20-AUG-2013		5.4
I-7 52 M	04-SEP-2013		ND
I-7 52 M	02-OCT-2013		4.2
I-7 52 M	06-NOV-2013		2.6
I-7 52 M	06-DEC-2013		3.0

ND=not detected

South Bay Ocean Outfall Monitoring  
Seawater Analysis for Total Suspended Solids and Hexane Extractable Material

From 01-JAN-2013 to 31-DEC-2013

Analyte:		HEM	TSS
MDL:		1.4	1.4
SOURCE	SAMPLE DATE	mg/L	mg/L
=====	=====	=====	=====
I-8 2 M	14-JAN-2013	ND	1.6
I-8 2 M	07-FEB-2013	ND	ND
I-8 2 M	07-MAR-2013	ND	3.6
I-8 2 M	05-APR-2013	ND	2.4
I-8 2 M	08-MAY-2013	ND	3.9
I-8 2 M	06-JUN-2013	ND	ND
I-8 2 M	11-JUL-2013	ND	ND
I-8 2 M	20-AUG-2013	1.90	3.5
I-8 2 M	04-SEP-2013	ND	1.6
I-8 2 M	02-OCT-2013	ND	4.1
I-8 2 M	06-NOV-2013	ND	2.5
I-8 2 M	06-DEC-2013	ND	4.6
I-8 18 M	14-JAN-2013		3.9
I-8 18 M	07-FEB-2013		1.5
I-8 18 M	07-MAR-2013		2.1
I-8 18 M	05-APR-2013		3.5
I-8 18 M	08-MAY-2013		2.7
I-8 18 M	06-JUN-2013		2.2
I-8 18 M	11-JUL-2013		1.6
I-8 18 M	20-AUG-2013		3.7
I-8 18 M	04-SEP-2013		4.2
I-8 18 M	02-OCT-2013		5.8
I-8 18 M	06-NOV-2013		2.1
I-8 18 M	06-DEC-2013		3.7
I-8 37 M	14-JAN-2013		2.0
I-8 37 M	07-FEB-2013		2.7
I-8 37 M	07-MAR-2013		4.0
I-8 37 M	05-APR-2013		3.1
I-8 37 M	08-MAY-2013		ND
I-8 37 M	06-JUN-2013		5.8
I-8 37 M	11-JUL-2013		1.9
I-8 37 M	20-AUG-2013		3.7
I-8 37 M	04-SEP-2013		1.8
I-8 37 M	02-OCT-2013		5.7
I-8 37 M	06-NOV-2013		2.0
I-8 37 M	06-DEC-2013		2.2
I-9 2 M	14-JAN-2013	ND	2.6
I-9 2 M	07-FEB-2013	ND	ND
I-9 2 M	07-MAR-2013	ND	3.1
I-9 2 M	05-APR-2013	ND	3.2
I-9 2 M	08-MAY-2013	ND	2.5
I-9 2 M	06-JUN-2013	ND	3.0
I-9 2 M	11-JUL-2013	ND	5.1
I-9 2 M	20-AUG-2013	ND	5.4
I-9 2 M	04-SEP-2013	ND	8.3
I-9 2 M	02-OCT-2013	ND	6.7
I-9 2 M	06-NOV-2013	ND	2.3
I-9 2 M	06-DEC-2013	ND	1.9
I-9 18 M	14-JAN-2013		2.7
I-9 18 M	07-FEB-2013		ND
I-9 18 M	07-MAR-2013		2.2
I-9 18 M	05-APR-2013		3.5
I-9 18 M	08-MAY-2013		ND
I-9 18 M	06-JUN-2013		2.2
I-9 18 M	11-JUL-2013		ND
I-9 18 M	20-AUG-2013		2.7

ND=not detected

South Bay Ocean Outfall Monitoring  
Seawater Analysis for Total Suspended Solids and Hexane Extractable Material

From 01-JAN-2013 to 31-DEC-2013

Analyte:		HEM	TSS
MDL:		1.4	1.4
SOURCE	SAMPLE DATE	mg/L	mg/L
=====	=====	=====	=====
I-9 18 M	04-SEP-2013		3.5
I-9 18 M	02-OCT-2013		4.2
I-9 18 M	06-NOV-2013		1.9
I-9 18 M	06-DEC-2013		3.5
I-9 27 M	14-JAN-2013		2.8
I-9 27 M	07-FEB-2013		3.6
I-9 27 M	07-MAR-2013		6.0
I-9 27 M	05-APR-2013		4.6
I-9 27 M	08-MAY-2013		1.5
I-9 27 M	06-JUN-2013		2.3
I-9 27 M	11-JUL-2013		ND
I-9 27 M	20-AUG-2013		ND
I-9 27 M	04-SEP-2013		ND
I-9 27 M	02-OCT-2013		3.0
I-9 27 M	06-NOV-2013		2.2
I-9 27 M	06-DEC-2013		4.3
I-10 2 M	14-JAN-2013	ND	2.9
I-10 2 M	07-FEB-2013	ND	2.2
I-10 2 M	07-MAR-2013	ND	2.8
I-10 2 M	05-APR-2013	ND	9.9
I-10 2 M	08-MAY-2013	ND	4.0
I-10 2 M	06-JUN-2013	ND	2.3
I-10 2 M	11-JUL-2013	ND	2.3
I-10 2 M	20-AUG-2013	1.60	20.6
I-10 2 M	04-SEP-2013	ND	7.1
I-10 2 M	02-OCT-2013	ND	6.6
I-10 2 M	06-NOV-2013	ND	1.6
I-10 2 M	06-DEC-2013	ND	4.8
I-10 12 M	14-JAN-2013		2.9
I-10 12 M	07-FEB-2013		4.1
I-10 12 M	07-MAR-2013		5.4
I-10 12 M	05-APR-2013		3.0
I-10 12 M	08-MAY-2013		2.2
I-10 12 M	06-JUN-2013		6.4
I-10 12 M	11-JUL-2013		5.8
I-10 12 M	20-AUG-2013		4.4
I-10 12 M	04-SEP-2013		4.6
I-10 12 M	02-OCT-2013		6.8
I-10 12 M	06-NOV-2013		3.0
I-10 12 M	06-DEC-2013		6.3
I-10 18 M	14-JAN-2013		3.0
I-10 18 M	07-FEB-2013		1.9
I-10 18 M	07-MAR-2013		6.2
I-10 18 M	05-APR-2013		3.6
I-10 18 M	08-MAY-2013		2.2
I-10 18 M	06-JUN-2013		1.9
I-10 18 M	11-JUL-2013		3.1
I-10 18 M	20-AUG-2013		3.0
I-10 18 M	04-SEP-2013		4.4
I-10 18 M	02-OCT-2013		4.5
I-10 18 M	06-NOV-2013		4.1
I-10 18 M	06-DEC-2013		5.8
I-11 2 M	14-JAN-2013	ND	3.3
I-11 2 M	07-FEB-2013	ND	3.3
I-11 2 M	07-MAR-2013	ND	4.4
I-11 2 M	05-APR-2013	ND	7.7
I-11 2 M	08-MAY-2013	ND	2.2

ND=not detected

South Bay Ocean Outfall Monitoring  
Seawater Analysis for Total Suspended Solids and Hexane Extractable Material

From 01-JAN-2013 to 31-DEC-2013

Analyte:			HEM	TSS
MDL:			1.4	1.4
SOURCE		SAMPLE DATE	mg/L	mg/L
=====		=====	=====	=====
I-11	2 M	06-JUN-2013	ND	2.2
I-11	2 M	11-JUL-2013	ND	4.2
I-11	2 M	20-AUG-2013	3.80	38.8
I-11	2 M	04-SEP-2013	ND	8.2
I-11	2 M	02-OCT-2013	ND	8.3
I-11	2 M	06-NOV-2013	ND	3.8
I-11	2 M	06-DEC-2013	ND	5.3
I-11	6 M	14-JAN-2013		2.8
I-11	6 M	07-FEB-2013		2.7
I-11	6 M	07-MAR-2013		5.2
I-11	6 M	05-APR-2013		3.8
I-11	6 M	08-MAY-2013		2.9
I-11	6 M	06-JUN-2013		2.1
I-11	6 M	11-JUL-2013		2.3
I-11	6 M	20-AUG-2013		10.5
I-11	6 M	04-SEP-2013		2.8
I-11	6 M	02-OCT-2013		7.5
I-11	6 M	06-NOV-2013		4.2
I-11	6 M	06-DEC-2013		5.6
I-11	11 M	14-JAN-2013		2.5
I-11	11 M	07-FEB-2013		11.0
I-11	11 M	07-MAR-2013		17.2
I-11	11 M	05-APR-2013		6.6
I-11	11 M	08-MAY-2013		3.1
I-11	11 M	06-JUN-2013		5.4
I-11	11 M	11-JUL-2013		1.8
I-11	11 M	20-AUG-2013		2.8
I-11	11 M	04-SEP-2013		5.0
I-11	11 M	02-OCT-2013		8.4
I-11	11 M	06-NOV-2013		3.0
I-11	11 M	06-DEC-2013		6.0
I-12	2 M	09-JAN-2013	ND	1.9
I-12	2 M	06-FEB-2013	ND	1.8
I-12	2 M	12-MAR-2013	ND	4.0
I-12	2 M	04-APR-2013	ND	ND
I-12	2 M	09-MAY-2013	ND	2.8
I-12	2 M	05-JUN-2013	ND	2.6
I-12	2 M	10-JUL-2013	ND	3.8
I-12	2 M	21-AUG-2013	ND	1.5
I-12	2 M	05-SEP-2013	ND	ND
I-12	2 M	01-OCT-2013	ND	3.2
I-12	2 M	07-NOV-2013	ND	2.6
I-12	2 M	05-DEC-2013	ND	3.8
I-12	18 M	09-JAN-2013		1.5
I-12	18 M	06-FEB-2013		3.1
I-12	18 M	12-MAR-2013		3.8
I-12	18 M	04-APR-2013		2.7
I-12	18 M	09-MAY-2013		1.9
I-12	18 M	05-JUN-2013		ND
I-12	18 M	10-JUL-2013		6.2
I-12	18 M	21-AUG-2013		ND
I-12	18 M	05-SEP-2013		2.2
I-12	18 M	01-OCT-2013		2.8
I-12	18 M	07-NOV-2013		2.5
I-12	18 M	05-DEC-2013		2.6

ND=not detected

South Bay Ocean Outfall Monitoring  
Seawater Analysis for Total Suspended Solids and Hexane Extractable Material

From 01-JAN-2013 to 31-DEC-2013

Analyte:			HEM	TSS
MDL:			1.4	1.4
SOURCE	SAMPLE DATE		mg/L	mg/L
=====	=====	=====	=====	=====
I-12 27 M	09-JAN-2013			3.3
I-12 27 M	06-FEB-2013			2.7
I-12 27 M	12-MAR-2013			3.5
I-12 27 M	04-APR-2013			2.4
I-12 27 M	09-MAY-2013			1.6
I-12 27 M	05-JUN-2013			5.6
I-12 27 M	10-JUL-2013			2.7
I-12 27 M	21-AUG-2013			1.5
I-12 27 M	05-SEP-2013			2.5
I-12 27 M	01-OCT-2013			4.9
I-12 27 M	07-NOV-2013			3.2
I-12 27 M	05-DEC-2013			2.5
I-13 2 M	14-JAN-2013	ND		2.0
I-13 2 M	07-FEB-2013	ND		2.4
I-13 2 M	07-MAR-2013	ND		2.8
I-13 2 M	05-APR-2013	ND		3.3
I-13 2 M	08-MAY-2013	ND		ND
I-13 2 M	06-JUN-2013	ND		2.5
I-13 2 M	11-JUL-2013	ND		2.0
I-13 2 M	20-AUG-2013	ND		ND
I-13 2 M	04-SEP-2013	ND		3.4
I-13 2 M	02-OCT-2013	ND		5.0
I-13 2 M	06-NOV-2013	ND		3.2
I-13 2 M	06-DEC-2013	ND		5.1
I-13 18 M	14-JAN-2013			1.8
I-13 18 M	07-FEB-2013			ND
I-13 18 M	07-MAR-2013			3.1
I-13 18 M	05-APR-2013			3.0
I-13 18 M	08-MAY-2013			ND
I-13 18 M	06-JUN-2013			2.0
I-13 18 M	11-JUL-2013			4.0
I-13 18 M	20-AUG-2013			1.8
I-13 18 M	04-SEP-2013			2.4
I-13 18 M	02-OCT-2013			4.0
I-13 18 M	06-NOV-2013			3.3
I-13 18 M	06-DEC-2013			3.5
I-13 37 M	14-JAN-2013			2.0
I-13 37 M	07-FEB-2013			4.4
I-13 37 M	07-MAR-2013			4.0
I-13 37 M	05-APR-2013			1.7
I-13 37 M	08-MAY-2013			ND
I-13 37 M	06-JUN-2013			ND
I-13 37 M	11-JUL-2013			ND
I-13 37 M	20-AUG-2013			2.2
I-13 37 M	04-SEP-2013			2.6
I-13 37 M	02-OCT-2013			5.0
I-13 37 M	06-NOV-2013			3.1
I-13 37 M	06-DEC-2013			ND
I-14 2 M	09-JAN-2013	ND		ND
I-14 2 M	06-FEB-2013	ND		ND
I-14 2 M	12-MAR-2013	ND		3.1
I-14 2 M	04-APR-2013	ND		3.3
I-14 2 M	09-MAY-2013	ND		2.3
I-14 2 M	05-JUN-2013	ND		1.7
I-14 2 M	10-JUL-2013	ND		4.1
I-14 2 M	21-AUG-2013	ND		1.5
I-14 2 M	05-SEP-2013	ND		2.1

ND=not detected

South Bay Ocean Outfall Monitoring  
Seawater Analysis for Total Suspended Solids and Hexane Extractable Material

From 01-JAN-2013 to 31-DEC-2013

Analyte:		HEM	TSS
MDL:		1.4	1.4
SOURCE	SAMPLE DATE	mg/L	mg/L
=====	=====	=====	=====
I-14 2 M	01-OCT-2013	ND	4.6
I-14 2 M	07-NOV-2013	ND	3.1
I-14 2 M	05-DEC-2013	ND	4.3
I-14 18 M	09-JAN-2013		2.0
I-14 18 M	06-FEB-2013		ND
I-14 18 M	12-MAR-2013		2.8
I-14 18 M	04-APR-2013		3.9
I-14 18 M	09-MAY-2013		5.2
I-14 18 M	05-JUN-2013		2.3
I-14 18 M	10-JUL-2013		5.9
I-14 18 M	21-AUG-2013		1.5
I-14 18 M	05-SEP-2013		2.1
I-14 18 M	01-OCT-2013		2.6
I-14 18 M	07-NOV-2013		4.0
I-14 18 M	05-DEC-2013		2.2
I-14 27 M	09-JAN-2013		3.8
I-14 27 M	06-FEB-2013		2.0
I-14 27 M	12-MAR-2013		2.6
I-14 27 M	04-APR-2013		3.1
I-14 27 M	09-MAY-2013		3.3
I-14 27 M	05-JUN-2013		2.3
I-14 27 M	10-JUL-2013		3.0
I-14 27 M	21-AUG-2013		ND
I-14 27 M	05-SEP-2013		2.1
I-14 27 M	01-OCT-2013		4.6
I-14 27 M	07-NOV-2013		3.7
I-14 27 M	05-DEC-2013		3.2
I-16 2 M	09-JAN-2013	ND	2.3
I-16 2 M	06-FEB-2013	ND	<1.4
I-16 2 M	12-MAR-2013	ND	3.1
I-16 2 M	04-APR-2013	ND	2.9
I-16 2 M	09-MAY-2013	ND	2.3
I-16 2 M	05-JUN-2013	ND	ND
I-16 2 M	10-JUL-2013	ND	5.2
I-16 2 M	21-AUG-2013	ND	ND
I-16 2 M	05-SEP-2013	ND	<1.4
I-16 2 M	01-OCT-2013	ND	4.6
I-16 2 M	07-NOV-2013	ND	3.4
I-16 2 M	05-DEC-2013	ND	3.6
I-16 18 M	09-JAN-2013		2.3
I-16 18 M	06-FEB-2013		ND
I-16 18 M	12-MAR-2013		2.1
I-16 18 M	04-APR-2013		3.6
I-16 18 M	09-MAY-2013		ND
I-16 18 M	05-JUN-2013		3.3
I-16 18 M	10-JUL-2013		1.5
I-16 18 M	21-AUG-2013		ND
I-16 18 M	05-SEP-2013		2.5
I-16 18 M	01-OCT-2013		2.7
I-16 18 M	07-NOV-2013		2.7
I-16 18 M	05-DEC-2013		3.3
I-16 27 M	09-JAN-2013		3.5
I-16 27 M	06-FEB-2013		1.6
I-16 27 M	12-MAR-2013		2.4
I-16 27 M	04-APR-2013		3.5
I-16 27 M	09-MAY-2013		1.8

ND=not detected

South Bay Ocean Outfall Monitoring  
Seawater Analysis for Total Suspended Solids and Hexane Extractable Material

From 01-JAN-2013 to 31-DEC-2013

Analyte:		HEM	TSS
MDL:		1.4	1.4
SOURCE	SAMPLE DATE	mg/L	mg/L
=====	=====	=====	=====
I-16 27 M	05-JUN-2013		2.2
I-16 27 M	10-JUL-2013		5.0
I-16 27 M	21-AUG-2013		1.7
I-16 27 M	05-SEP-2013		3.3
I-16 27 M	01-OCT-2013		5.0
I-16 27 M	07-NOV-2013		2.9
I-16 27 M	05-DEC-2013		2.9
I-18 2 M	09-JAN-2013	ND	2.0
I-18 2 M	06-FEB-2013	ND	ND
I-18 2 M	12-MAR-2013	ND	3.8
I-18 2 M	04-APR-2013	ND	7.3
I-18 2 M	09-MAY-2013	ND	1.7
I-18 2 M	05-JUN-2013	ND	2.6
I-18 2 M	10-JUL-2013	ND	2.0
I-18 2 M	21-AUG-2013	ND	4.2
I-18 2 M	05-SEP-2013	1.40	2.7
I-18 2 M	01-OCT-2013	ND	7.3
I-18 2 M	07-NOV-2013	ND	3.7
I-18 2 M	05-DEC-2013	ND	4.3
I-18 12 M	09-JAN-2013		3.1
I-18 12 M	06-FEB-2013		ND
I-18 12 M	12-MAR-2013		2.6
I-18 12 M	04-APR-2013		3.4
I-18 12 M	09-MAY-2013		2.4
I-18 12 M	05-JUN-2013		3.5
I-18 12 M	10-JUL-2013		2.7
I-18 12 M	21-AUG-2013		1.7
I-18 12 M	05-SEP-2013		1.5
I-18 12 M	01-OCT-2013		3.4
I-18 12 M	07-NOV-2013		4.4
I-18 12 M	05-DEC-2013		4.8
I-18 18 M	09-JAN-2013		3.3
I-18 18 M	06-FEB-2013		2.1
I-18 18 M	12-MAR-2013		3.4
I-18 18 M	04-APR-2013		2.9
I-18 18 M	09-MAY-2013		1.7
I-18 18 M	05-JUN-2013		2.7
I-18 18 M	10-JUL-2013		1.9
I-18 18 M	21-AUG-2013		1.5
I-18 18 M	05-SEP-2013		2.6
I-18 18 M	01-OCT-2013		4.7
I-18 18 M	07-NOV-2013		3.7
I-18 18 M	05-DEC-2013		5.0
I-19 2 M	09-JAN-2013	ND	5.4
I-19 2 M	06-FEB-2013	ND	4.4
I-19 2 M	12-MAR-2013	ND	13.2
I-19 2 M	04-APR-2013	ND	4.9
I-19 2 M	09-MAY-2013	ND	2.2
I-19 2 M	05-JUN-2013	ND	2.8
I-19 2 M	10-JUL-2013	ND	3.2
I-19 2 M	21-AUG-2013	ND	2.1
I-19 2 M	05-SEP-2013	2.30	9.0
I-19 2 M	01-OCT-2013	ND	4.3
I-19 2 M	07-NOV-2013	ND	6.1
I-19 2 M	05-DEC-2013	ND	6.5

ND=not detected



South Bay Ocean Outfall Monitoring  
Seawater Analysis for Total Suspended Solids and Hexane Extractable Material

From 01-JAN-2013 to 31-DEC-2013

Analyte:		HEM	TSS
MDL:		1.4	1.4
SOURCE	SAMPLE DATE	mg/L	mg/L
=====	=====	=====	=====
I-19 6 M	09-JAN-2013		3.5
I-19 6 M	06-FEB-2013		4.0
I-19 6 M	12-MAR-2013		13.8
I-19 6 M	04-APR-2013		5.8
I-19 6 M	09-MAY-2013		2.7
I-19 6 M	05-JUN-2013		3.4
I-19 6 M	10-JUL-2013		2.9
I-19 6 M	21-AUG-2013		5.2
I-19 6 M	05-SEP-2013		3.4
I-19 6 M	01-OCT-2013		6.4
I-19 6 M	07-NOV-2013		6.7
I-19 6 M	05-DEC-2013		6.5
I-19 11 M	09-JAN-2013		7.5
I-19 11 M	06-FEB-2013		13.6
I-19 11 M	12-MAR-2013		15.6
I-19 11 M	04-APR-2013		5.9
I-19 11 M	09-MAY-2013		11.5
I-19 11 M	05-JUN-2013		6.0
I-19 11 M	10-JUL-2013		9.2
I-19 11 M	21-AUG-2013		4.0
I-19 11 M	05-SEP-2013		14.6
I-19 11 M	01-OCT-2013		13.8
I-19 11 M	07-NOV-2013		10.5
I-19 11 M	05-DEC-2013		8.5
I-20 2 M	14-JAN-2013	ND	1.7
I-20 2 M	07-FEB-2013	ND	2.2
I-20 2 M	07-MAR-2013	ND	2.3
I-20 2 M	05-APR-2013	ND	2.2
I-20 2 M	08-MAY-2013	ND	<1.4
I-20 2 M	06-JUN-2013	ND	2.2
I-20 2 M	11-JUL-2013	ND	2.8
I-20 2 M	20-AUG-2013	ND	2.0
I-20 2 M	04-SEP-2013	ND	5.3
I-20 2 M	02-OCT-2013	ND	4.7
I-20 2 M	06-NOV-2013	ND	3.0
I-20 2 M	06-DEC-2013	ND	3.0
I-20 18 M	14-JAN-2013		1.7
I-20 18 M	07-FEB-2013		3.2
I-20 18 M	07-MAR-2013		2.8
I-20 18 M	05-APR-2013		1.8
I-20 18 M	08-MAY-2013		ND
I-20 18 M	06-JUN-2013		1.9
I-20 18 M	11-JUL-2013		ND
I-20 18 M	20-AUG-2013		2.3
I-20 18 M	04-SEP-2013		4.1
I-20 18 M	02-OCT-2013		4.4
I-20 18 M	06-NOV-2013		2.7
I-20 18 M	06-DEC-2013		3.9
I-20 55 M	14-JAN-2013		1.8
I-20 55 M	07-FEB-2013		2.0
I-20 55 M	07-MAR-2013		2.4
I-20 55 M	05-APR-2013		3.9
I-20 55 M	08-MAY-2013		2.5
I-20 55 M	06-JUN-2013		2.6
I-20 55 M	11-JUL-2013		1.7
I-20 55 M	20-AUG-2013		5.5
I-20 55 M	04-SEP-2013		2.2

ND=not detected

South Bay Ocean Outfall Monitoring  
Seawater Analysis for Total Suspended Solids and Hexane Extractable Material

From 01-JAN-2013 to 31-DEC-2013

Analyte:			HEM	TSS
MDL:			1.4	1.4
SOURCE		SAMPLE DATE	mg/L	mg/L
=====		=====	=====	=====
I-20	55 M	02-OCT-2013		8.2
I-20	55 M	06-NOV-2013		3.1
I-20	55 M	06-DEC-2013		2.3
I-21	2 M	14-JAN-2013	ND	2.1
I-21	2 M	07-FEB-2013	ND	1.9
I-21	2 M	07-MAR-2013	ND	2.9
I-21	2 M	05-APR-2013	ND	1.8
I-21	2 M	08-MAY-2013	ND	ND
I-21	2 M	06-JUN-2013	ND	5.0
I-21	2 M	11-JUL-2013	ND	ND
I-21	2 M	20-AUG-2013	ND	5.6
I-21	2 M	04-SEP-2013	ND	4.5
I-21	2 M	02-OCT-2013	ND	6.9
I-21	2 M	06-NOV-2013	ND	3.0
I-21	2 M	06-DEC-2013	ND	4.1
I-21	18 M	14-JAN-2013		3.5
I-21	18 M	07-FEB-2013		2.1
I-21	18 M	07-MAR-2013		1.8
I-21	18 M	05-APR-2013		3.6
I-21	18 M	08-MAY-2013		2.3
I-21	18 M	06-JUN-2013		2.3
I-21	18 M	11-JUL-2013		4.7
I-21	18 M	20-AUG-2013		1.8
I-21	18 M	04-SEP-2013		2.7
I-21	18 M	02-OCT-2013		2.8
I-21	18 M	06-NOV-2013		1.5
I-21	18 M	06-DEC-2013		3.6
I-21	37 M	14-JAN-2013		5.7
I-21	37 M	07-FEB-2013		3.6
I-21	37 M	07-MAR-2013		2.9
I-21	37 M	05-APR-2013		2.8
I-21	37 M	08-MAY-2013		2.1
I-21	37 M	06-JUN-2013		3.0
I-21	37 M	11-JUL-2013		4.0
I-21	37 M	20-AUG-2013		ND
I-21	37 M	04-SEP-2013		3.8
I-21	37 M	02-OCT-2013		5.2
I-21	37 M	06-NOV-2013		2.2
I-21	37 M	06-DEC-2013		3.2
I-22	2 M	09-JAN-2013	ND	2.7
I-22	2 M	06-FEB-2013	ND	1.9
I-22	2 M	12-MAR-2013	ND	3.2
I-22	2 M	04-APR-2013	ND	4.5
I-22	2 M	09-MAY-2013	ND	4.4
I-22	2 M	05-JUN-2013	ND	ND
I-22	2 M	10-JUL-2013	ND	5.5
I-22	2 M	21-AUG-2013	ND	ND
I-22	2 M	05-SEP-2013	ND	1.7
I-22	2 M	01-OCT-2013	ND	4.1
I-22	2 M	07-NOV-2013	ND	3.6
I-22	2 M	05-DEC-2013	ND	4.5
I-22	18 M	09-JAN-2013		2.3
I-22	18 M	06-FEB-2013		1.9
I-22	18 M	12-MAR-2013		2.8
I-22	18 M	04-APR-2013		ND
I-22	18 M	09-MAY-2013		2.8

ND=not detected

South Bay Ocean Outfall Monitoring  
Seawater Analysis for Total Suspended Solids and Hexane Extractable Material

From 01-JAN-2013 to 31-DEC-2013

Analyte:			HEM	TSS
MDL:			1.4	1.4
SOURCE	SAMPLE DATE		mg/L	mg/L
=====	=====	=====	=====	=====
I-22	18 M	05-JUN-2013		ND
I-22	18 M	10-JUL-2013		6.4
I-22	18 M	21-AUG-2013		2.4
I-22	18 M	05-SEP-2013		ND
I-22	18 M	01-OCT-2013		2.0
I-22	18 M	07-NOV-2013		4.1
I-22	18 M	05-DEC-2013		2.7
I-22	27 M	09-JAN-2013		7.0
I-22	27 M	06-FEB-2013		1.9
I-22	27 M	12-MAR-2013		ND
I-22	27 M	04-APR-2013		4.1
I-22	27 M	09-MAY-2013		1.7
I-22	27 M	05-JUN-2013		2.0
I-22	27 M	10-JUL-2013		2.7
I-22	27 M	21-AUG-2013		ND
I-22	27 M	05-SEP-2013		1.6
I-22	27 M	01-OCT-2013		3.6
I-22	27 M	07-NOV-2013		6.4
I-22	27 M	05-DEC-2013		4.3
I-23	2 M	09-JAN-2013	ND	2.8
I-23	2 M	06-FEB-2013	ND	2.3
I-23	2 M	12-MAR-2013	ND	3.5
I-23	2 M	04-APR-2013	ND	6.7
I-23	2 M	09-MAY-2013	ND	2.2
I-23	2 M	05-JUN-2013	ND	1.6
I-23	2 M	10-JUL-2013	ND	2.4
I-23	2 M	21-AUG-2013	ND	1.9
I-23	2 M	05-SEP-2013	ND	2.7
I-23	2 M	01-OCT-2013	ND	4.4
I-23	2 M	07-NOV-2013	ND	4.4
I-23	2 M	05-DEC-2013	ND	4.0
I-23	12 M	09-JAN-2013		3.2
I-23	12 M	06-FEB-2013		2.7
I-23	12 M	12-MAR-2013		4.0
I-23	12 M	04-APR-2013		3.3
I-23	12 M	09-MAY-2013		ND
I-23	12 M	05-JUN-2013		2.5
I-23	12 M	10-JUL-2013		6.9
I-23	12 M	21-AUG-2013		1.5
I-23	12 M	05-SEP-2013		2.0
I-23	12 M	01-OCT-2013		3.7
I-23	12 M	07-NOV-2013		5.7
I-23	12 M	05-DEC-2013		5.6
I-23	18 M	09-JAN-2013		4.1
I-23	18 M	06-FEB-2013		4.6
I-23	18 M	12-MAR-2013		4.4
I-23	18 M	04-APR-2013		3.1
I-23	18 M	09-MAY-2013		1.5
I-23	18 M	05-JUN-2013		3.5
I-23	18 M	10-JUL-2013		4.8
I-23	18 M	21-AUG-2013		1.9
I-23	18 M	05-SEP-2013		2.3
I-23	18 M	01-OCT-2013		5.9
I-23	18 M	07-NOV-2013		4.2
I-23	18 M	05-DEC-2013		5.3

ND=not detected

South Bay Ocean Outfall Monitoring  
Seawater Analysis for Total Suspended Solids and Hexane Extractable Material

From 01-JAN-2013 to 31-DEC-2013

Analyte:			HEM	TSS
MDL:			1.4	1.4
SOURCE		SAMPLE DATE	mg/L	mg/L
=====		=====	=====	=====
I-24	2 M	09-JAN-2013	ND	3.2
I-24	2 M	06-FEB-2013	ND	2.6
I-24	2 M	12-MAR-2013	ND	6.8
I-24	2 M	04-APR-2013	ND	9.0
I-24	2 M	09-MAY-2013	ND	1.9
I-24	2 M	05-JUN-2013	ND	2.5
I-24	2 M	10-JUL-2013	ND	2.7
I-24	2 M	21-AUG-2013	ND	1.5
I-24	2 M	05-SEP-2013	ND	1.8
I-24	2 M	01-OCT-2013	ND	5.5
I-24	2 M	07-NOV-2013	ND	5.0
I-24	2 M	05-DEC-2013	ND	9.4
I-24	6 M	09-JAN-2013		4.7
I-24	6 M	06-FEB-2013		3.0
I-24	6 M	12-MAR-2013		7.0
I-24	6 M	04-APR-2013		3.9
I-24	6 M	09-MAY-2013		1.8
I-24	6 M	05-JUN-2013		3.2
I-24	6 M	10-JUL-2013		5.2
I-24	6 M	21-AUG-2013		ND
I-24	6 M	05-SEP-2013		3.8
I-24	6 M	01-OCT-2013		4.9
I-24	6 M	07-NOV-2013		4.6
I-24	6 M	05-DEC-2013		11.1
I-24	11 M	09-JAN-2013		4.1
I-24	11 M	06-FEB-2013		4.6
I-24	11 M	12-MAR-2013		10.0
I-24	11 M	04-APR-2013		5.1
I-24	11 M	09-MAY-2013		4.3
I-24	11 M	05-JUN-2013		5.9
I-24	11 M	10-JUL-2013		14.6
I-24	11 M	21-AUG-2013		4.2
I-24	11 M	05-SEP-2013		2.8
I-24	11 M	01-OCT-2013		5.4
I-24	11 M	07-NOV-2013		10.0
I-24	11 M	05-DEC-2013		10.7
I-25	2 M	09-JAN-2013	ND	3.2
I-25	2 M	06-FEB-2013	ND	2.4
I-25	2 M	12-MAR-2013	ND	4.7
I-25	2 M	04-APR-2013	ND	8.0
I-25	2 M	09-MAY-2013	ND	1.6
I-25	2 M	05-JUN-2013	ND	2.1
I-25	2 M	10-JUL-2013	ND	2.0
I-25	2 M	21-AUG-2013	ND	2.7
I-25	2 M	05-SEP-2013	ND	3.8
I-25	2 M	01-OCT-2013	ND	7.1
I-25	2 M	07-NOV-2013	ND	7.3
I-25	2 M	05-DEC-2013	ND	9.2
I-25	6 M	09-JAN-2013		3.6
I-25	6 M	06-FEB-2013		3.9
I-25	6 M	12-MAR-2013		7.6
I-25	6 M	04-APR-2013		4.3
I-25	6 M	09-MAY-2013		2.2
I-25	6 M	05-JUN-2013		3.0
I-25	6 M	10-JUL-2013		3.1

ND=not detected

South Bay Ocean Outfall Monitoring  
Seawater Analysis for Total Suspended Solids and Hexane Extractable Material

From 01-JAN-2013 to 31-DEC-2013

Analyte:			HEM	TSS
MDL:			1.4	1.4
SOURCE		SAMPLE DATE	mg/L	mg/L
=====		=====	=====	=====
I-25	6 M	21-AUG-2013		1.5
I-25	6 M	05-SEP-2013		7.5
I-25	6 M	01-OCT-2013		6.0
I-25	6 M	07-NOV-2013		4.6
I-25	6 M	05-DEC-2013		9.5
I-25	9 M	09-JAN-2013		3.6
I-25	9 M	06-FEB-2013		4.8
I-25	9 M	12-MAR-2013		9.0
I-25	9 M	04-APR-2013		9.5
I-25	9 M	09-MAY-2013		2.6
I-25	9 M	05-JUN-2013		5.3
I-25	9 M	10-JUL-2013		3.3
I-25	9 M	21-AUG-2013		4.9
I-25	9 M	05-SEP-2013		4.3
I-25	9 M	01-OCT-2013		7.2
I-25	9 M	07-NOV-2013		12.0
I-25	9 M	05-DEC-2013		10.7
I-26	2 M	09-JAN-2013	ND	3.3
I-26	2 M	06-FEB-2013	ND	2.1
I-26	2 M	12-MAR-2013	ND	4.5
I-26	2 M	04-APR-2013	ND	7.1
I-26	2 M	09-MAY-2013	ND	2.4
I-26	2 M	05-JUN-2013	ND	1.6
I-26	2 M	10-JUL-2013	ND	2.9
I-26	2 M	21-AUG-2013	ND	1.7
I-26	2 M	05-SEP-2013	ND	3.8
I-26	2 M	01-OCT-2013	ND	2.8
I-26	2 M	07-NOV-2013	ND	4.5
I-26	2 M	05-DEC-2013	ND	4.1
I-26	6 M	09-JAN-2013		3.2
I-26	6 M	06-FEB-2013		3.7
I-26	6 M	12-MAR-2013		4.0
I-26	6 M	04-APR-2013		7.4
I-26	6 M	09-MAY-2013		1.7
I-26	6 M	05-JUN-2013		2.1
I-26	6 M	10-JUL-2013		7.8
I-26	6 M	21-AUG-2013		1.4
I-26	6 M	05-SEP-2013		1.9
I-26	6 M	01-OCT-2013		5.1
I-26	6 M	07-NOV-2013		4.3
I-26	6 M	05-DEC-2013		5.2
I-26	9 M	09-JAN-2013		3.6
I-26	9 M	06-FEB-2013		4.3
I-26	9 M	12-MAR-2013		3.8
I-26	9 M	04-APR-2013		9.6
I-26	9 M	09-MAY-2013		2.5
I-26	9 M	05-JUN-2013		7.1
I-26	9 M	10-JUL-2013		6.6
I-26	9 M	21-AUG-2013		3.1
I-26	9 M	05-SEP-2013		1.6
I-26	9 M	01-OCT-2013		5.0
I-26	9 M	07-NOV-2013		4.4
I-26	9 M	05-DEC-2013		7.6
I-30	2 M	08-JAN-2013	ND	ND
I-30	2 M	05-FEB-2013	ND	1.9
I-30	2 M	05-MAR-2013	ND	2.9

ND=not detected

South Bay Ocean Outfall Monitoring  
Seawater Analysis for Total Suspended Solids and Hexane Extractable Material

From 01-JAN-2013 to 31-DEC-2013

Analyte:			HEM	TSS
MDL:			1.4	1.4
SOURCE		SAMPLE DATE	mg/L	mg/L
=====		=====	=====	=====
I-30	2 M	03-APR-2013	ND	3.6
I-30	2 M	07-MAY-2013	ND	2.9
I-30	2 M	04-JUN-2013	ND	6.7
I-30	2 M	12-JUL-2013	ND	3.4
I-30	2 M	19-AUG-2013	ND	2.5
I-30	2 M	03-SEP-2013	ND	2.4
I-30	2 M	03-OCT-2013	ND	4.4
I-30	2 M	08-NOV-2013	ND	3.2
I-30	2 M	03-DEC-2013	ND	3.2
I-30	18 M	08-JAN-2013		1.5
I-30	18 M	05-FEB-2013		ND
I-30	18 M	05-MAR-2013		2.8
I-30	18 M	03-APR-2013		3.3
I-30	18 M	07-MAY-2013		3.6
I-30	18 M	04-JUN-2013		3.5
I-30	18 M	12-JUL-2013		3.7
I-30	18 M	19-AUG-2013		3.0
I-30	18 M	03-SEP-2013		1.6
I-30	18 M	03-OCT-2013		5.1
I-30	18 M	08-NOV-2013		3.3
I-30	18 M	03-DEC-2013		2.8
I-30	27 M	08-JAN-2013		3.4
I-30	27 M	05-FEB-2013		3.1
I-30	27 M	05-MAR-2013		4.6
I-30	27 M	03-APR-2013		2.8
I-30	27 M	07-MAY-2013		8.7
I-30	27 M	04-JUN-2013		2.6
I-30	27 M	12-JUL-2013		2.8
I-30	27 M	19-AUG-2013		1.8
I-30	27 M	03-SEP-2013		3.0
I-30	27 M	03-OCT-2013		3.9
I-30	27 M	08-NOV-2013		3.1
I-30	27 M	03-DEC-2013		4.5
I-32	2 M	08-JAN-2013	ND	3.7
I-32	2 M	05-FEB-2013	ND	3.1
I-32	2 M	05-MAR-2013	ND	3.8
I-32	2 M	03-APR-2013	ND	6.3
I-32	2 M	07-MAY-2013	ND	9.3
I-32	2 M	04-JUN-2013	ND	8.5
I-32	2 M	12-JUL-2013	ND	ND
I-32	2 M	19-AUG-2013	ND	2.6
I-32	2 M	03-SEP-2013	ND	19.2
I-32	2 M	03-OCT-2013	ND	5.4
I-32	2 M	08-NOV-2013	ND	6.5
I-32	2 M	03-DEC-2013	ND	7.3
I-32	6 M	08-JAN-2013		4.5
I-32	6 M	05-FEB-2013		4.9
I-32	6 M	05-MAR-2013		4.9
I-32	6 M	03-APR-2013		7.0
I-32	6 M	07-MAY-2013		7.4
I-32	6 M	04-JUN-2013		6.8
I-32	6 M	12-JUL-2013		2.1
I-32	6 M	19-AUG-2013		2.7
I-32	6 M	03-SEP-2013		6.1
I-32	6 M	03-OCT-2013		5.5
I-32	6 M	08-NOV-2013		9.7

ND=not detected

South Bay Ocean Outfall Monitoring  
Seawater Analysis for Total Suspended Solids and Hexane Extractable Material

From 01-JAN-2013 to 31-DEC-2013

Analyte:			HEM	TSS
MDL:			1.4	1.4
SOURCE		SAMPLE DATE	mg/L	mg/L
=====		=====	=====	=====
I-32	6 M	03-DEC-2013		5.8
I-32	9 M	08-JAN-2013		6.9
I-32	9 M	05-FEB-2013		6.9
I-32	9 M	05-MAR-2013		11.2
I-32	9 M	03-APR-2013		6.6
I-32	9 M	07-MAY-2013		9.1
I-32	9 M	04-JUN-2013		12.6
I-32	9 M	12-JUL-2013		8.4
I-32	9 M	19-AUG-2013		3.4
I-32	9 M	03-SEP-2013		5.8
I-32	9 M	03-OCT-2013		7.7
I-32	9 M	08-NOV-2013		11.1
I-32	9 M	03-DEC-2013		5.7
I-33	2 M	08-JAN-2013	ND	1.9
I-33	2 M	05-FEB-2013	ND	ND
I-33	2 M	05-MAR-2013	ND	3.4
I-33	2 M	03-APR-2013	ND	2.4
I-33	2 M	07-MAY-2013	ND	3.2
I-33	2 M	04-JUN-2013	ND	2.5
I-33	2 M	12-JUL-2013	ND	ND
I-33	2 M	19-AUG-2013	ND	ND
I-33	2 M	03-SEP-2013	ND	3.4
I-33	2 M	03-OCT-2013	ND	6.4
I-33	2 M	08-NOV-2013	ND	3.1
I-33	2 M	03-DEC-2013	ND	2.7
I-33	18 M	08-JAN-2013		ND
I-33	18 M	05-FEB-2013		3.4
I-33	18 M	05-MAR-2013		3.2
I-33	18 M	03-APR-2013		ND
I-33	18 M	07-MAY-2013		6.7
I-33	18 M	04-JUN-2013		3.8
I-33	18 M	12-JUL-2013		2.5
I-33	18 M	19-AUG-2013		ND
I-33	18 M	03-SEP-2013		2.7
I-33	18 M	03-OCT-2013		2.9
I-33	18 M	08-NOV-2013		3.7
I-33	18 M	03-DEC-2013		3.2
I-33	27 M	08-JAN-2013		2.6
I-33	27 M	05-FEB-2013		3.3
I-33	27 M	05-MAR-2013		3.1
I-33	27 M	03-APR-2013		1.6
I-33	27 M	07-MAY-2013		2.6
I-33	27 M	04-JUN-2013		2.8
I-33	27 M	12-JUL-2013		1.5
I-33	27 M	19-AUG-2013		2.2
I-33	27 M	03-SEP-2013		2.6
I-33	27 M	03-OCT-2013		2.4
I-33	27 M	08-NOV-2013		2.8
I-33	27 M	03-DEC-2013		2.8
I-36	2 M	08-JAN-2013	ND	2.7
I-36	2 M	05-FEB-2013	ND	4.2
I-36	2 M	05-MAR-2013	ND	3.3
I-36	2 M	03-APR-2013	ND	3.9
I-36	2 M	07-MAY-2013	ND	8.2
I-36	2 M	04-JUN-2013	ND	5.9
I-36	2 M	12-JUL-2013	ND	1.8
I-36	2 M	19-AUG-2013	ND	4.3

ND=not detected

South Bay Ocean Outfall Monitoring  
Seawater Analysis for Total Suspended Solids and Hexane Extractable Material

From 01-JAN-2013 to 31-DEC-2013

Analyte:		HEM	TSS
MDL:		1.4	1.4
SOURCE	SAMPLE DATE	mg/L	mg/L
=====	=====	=====	=====
I-36 2 M	03-SEP-2013	ND	10.1
I-36 2 M	03-OCT-2013	ND	3.8
I-36 2 M	08-NOV-2013	ND	4.7
I-36 2 M	03-DEC-2013	ND	3.4
I-36 6 M	08-JAN-2013		3.0
I-36 6 M	05-FEB-2013		9.4
I-36 6 M	05-MAR-2013		4.3
I-36 6 M	03-APR-2013		3.6
I-36 6 M	07-MAY-2013		6.2
I-36 6 M	04-JUN-2013		4.5
I-36 6 M	12-JUL-2013		2.4
I-36 6 M	19-AUG-2013		ND
I-36 6 M	03-SEP-2013		7.9
I-36 6 M	03-OCT-2013		3.2
I-36 6 M	08-NOV-2013		5.0
I-36 6 M	03-DEC-2013		4.1
I-36 11 M	08-JAN-2013		7.2
I-36 11 M	05-FEB-2013		11.4
I-36 11 M	05-MAR-2013		6.4
I-36 11 M	03-APR-2013		9.8
I-36 11 M	07-MAY-2013		7.6
I-36 11 M	04-JUN-2013		8.8
I-36 11 M	12-JUL-2013		3.2
I-36 11 M	19-AUG-2013		7.5
I-36 11 M	03-SEP-2013		3.7
I-36 11 M	03-OCT-2013		4.9
I-36 11 M	08-NOV-2013		6.9
I-36 11 M	03-DEC-2013		7.8
I-37 2 M	08-JAN-2013	ND	3.8
I-37 2 M	05-FEB-2013	ND	3.0
I-37 2 M	05-MAR-2013	ND	4.0
I-37 2 M	03-APR-2013	ND	8.8
I-37 2 M	07-MAY-2013	ND	4.3
I-37 2 M	04-JUN-2013	ND	6.3
I-37 2 M	12-JUL-2013	ND	4.8
I-37 2 M	19-AUG-2013	ND	2.6
I-37 2 M	03-SEP-2013	ND	5.1
I-37 2 M	03-OCT-2013	ND	4.7
I-37 2 M	08-NOV-2013	ND	4.4
I-37 2 M	03-DEC-2013	ND	3.3
I-37 6 M	08-JAN-2013		1.8
I-37 6 M	05-FEB-2013		3.3
I-37 6 M	05-MAR-2013		4.8
I-37 6 M	03-APR-2013		2.8
I-37 6 M	07-MAY-2013		2.4
I-37 6 M	04-JUN-2013		7.9
I-37 6 M	12-JUL-2013		2.8
I-37 6 M	19-AUG-2013		2.4
I-37 6 M	03-SEP-2013		9.1
I-37 6 M	03-OCT-2013		4.0
I-37 6 M	08-NOV-2013		5.6
I-37 6 M	03-DEC-2013		3.6
I-37 11 M	08-JAN-2013		3.6
I-37 11 M	05-FEB-2013		6.0
I-37 11 M	05-MAR-2013		6.1
I-37 11 M	03-APR-2013		4.1

ND=not detected



South Bay Ocean Outfall Monitoring  
Seawater Analysis for Total Suspended Solids and Hexane Extractable Material

From 01-JAN-2013 to 31-DEC-2013

Analyte:			HEM	TSS
MDL:			1.4	1.4
SOURCE		SAMPLE DATE	mg/L	mg/L
=====		=====	=====	=====
I-37	11 M	07-MAY-2013		4.1
I-37	11 M	04-JUN-2013		10.2
I-37	11 M	12-JUL-2013		3.5
I-37	11 M	19-AUG-2013		2.1
I-37	11 M	03-SEP-2013		5.4
I-37	11 M	03-OCT-2013		3.7
I-37	11 M	08-NOV-2013		6.1
I-37	11 M	03-DEC-2013		2.7
I-38	2 M	08-JAN-2013	ND	3.8
I-38	2 M	05-FEB-2013	ND	3.3
I-38	2 M	05-MAR-2013	ND	2.8
I-38	2 M	03-APR-2013	ND	16.1
I-38	2 M	07-MAY-2013	ND	3.5
I-38	2 M	04-JUN-2013	ND	5.0
I-38	2 M	12-JUL-2013	ND	3.0
I-38	2 M	19-AUG-2013	ND	3.0
I-38	2 M	03-SEP-2013	ND	16.1
I-38	2 M	03-OCT-2013	ND	4.8
I-38	2 M	08-NOV-2013	ND	3.1
I-38	2 M	03-DEC-2013	ND	3.2
I-38	6 M	08-JAN-2013		4.9
I-38	6 M	05-FEB-2013		5.6
I-38	6 M	05-MAR-2013		3.3
I-38	6 M	03-APR-2013		7.7
I-38	6 M	07-MAY-2013		6.3
I-38	6 M	04-JUN-2013		4.9
I-38	6 M	12-JUL-2013		1.8
I-38	6 M	19-AUG-2013		3.1
I-38	6 M	03-SEP-2013		3.1
I-38	6 M	03-OCT-2013		4.2
I-38	6 M	08-NOV-2013		4.7
I-38	6 M	03-DEC-2013		9.4
I-38	11 M	08-JAN-2013		3.8
I-38	11 M	05-FEB-2013		5.9
I-38	11 M	05-MAR-2013		8.1
I-38	11 M	03-APR-2013		7.0
I-38	11 M	07-MAY-2013		8.4
I-38	11 M	04-JUN-2013		7.4
I-38	11 M	12-JUL-2013		7.4
I-38	11 M	19-AUG-2013		6.7
I-38	11 M	03-SEP-2013		4.2
I-38	11 M	03-OCT-2013		12.2
I-38	11 M	08-NOV-2013		5.4
I-38	11 M	03-DEC-2013		6.2
I-39	2 M	09-JAN-2013	ND	2.5
I-39	2 M	06-FEB-2013	ND	1.9
I-39	2 M	12-MAR-2013	ND	3.5
I-39	2 M	04-APR-2013	ND	4.1
I-39	2 M	09-MAY-2013	ND	1.6
I-39	2 M	05-JUN-2013	ND	3.1
I-39	2 M	10-JUL-2013	ND	3.0
I-39	2 M	21-AUG-2013	ND	2.8
I-39	2 M	05-SEP-2013	ND	3.4
I-39	2 M	01-OCT-2013	ND	5.6
I-39	2 M	07-NOV-2013	ND	4.1
I-39	2 M	05-DEC-2013	ND	8.5
I-39	12 M	09-JAN-2013		2.3
I-39	12 M	06-FEB-2013		1.8

ND=not detected

South Bay Ocean Outfall Monitoring  
Seawater Analysis for Total Suspended Solids and Hexane Extractable Material

From 01-JAN-2013 to 31-DEC-2013

Analyte:			HEM	TSS
MDL:			1.4	1.4
SOURCE		SAMPLE DATE	mg/L	mg/L
=====		=====	=====	=====
I-39	12 M	12-MAR-2013		2.9
I-39	12 M	04-APR-2013		2.9
I-39	12 M	09-MAY-2013		ND
I-39	12 M	05-JUN-2013		2.4
I-39	12 M	10-JUL-2013		2.9
I-39	12 M	21-AUG-2013		2.6
I-39	12 M	05-SEP-2013		3.1
I-39	12 M	01-OCT-2013		2.9
I-39	12 M	07-NOV-2013		5.4
I-39	12 M	05-DEC-2013		8.3
I-39	18 M	09-JAN-2013		4.9
I-39	18 M	06-FEB-2013		6.1
I-39	18 M	12-MAR-2013		3.8
I-39	18 M	04-APR-2013		3.0
I-39	18 M	09-MAY-2013		2.1
I-39	18 M	05-JUN-2013		3.2
I-39	18 M	10-JUL-2013		4.0
I-39	18 M	21-AUG-2013		2.9
I-39	18 M	05-SEP-2013		3.0
I-39	18 M	01-OCT-2013		4.9
I-39	18 M	07-NOV-2013		4.5
I-39	18 M	05-DEC-2013		10.6
I-40	2 M	09-JAN-2013	ND	6.5
I-40	2 M	06-FEB-2013	ND	8.0
I-40	2 M	12-MAR-2013	ND	5.9
I-40	2 M	04-APR-2013	ND	7.7
I-40	2 M	09-MAY-2013	ND	2.5
I-40	2 M	05-JUN-2013	ND	5.5
I-40	2 M	10-JUL-2013	ND	3.3
I-40	2 M	21-AUG-2013	ND	2.1
I-40	2 M	05-SEP-2013	ND	2.6
I-40	2 M	01-OCT-2013	ND	13.1
I-40	2 M	07-NOV-2013	ND	4.1
I-40	2 M	05-DEC-2013	ND	6.9
I-40	6 M	09-JAN-2013		5.6
I-40	6 M	06-FEB-2013		6.8
I-40	6 M	12-MAR-2013		5.7
I-40	6 M	04-APR-2013		9.8
I-40	6 M	09-MAY-2013		1.9
I-40	6 M	05-JUN-2013		4.5
I-40	6 M	10-JUL-2013		5.0
I-40	6 M	21-AUG-2013		2.2
I-40	6 M	05-SEP-2013		4.6
I-40	6 M	01-OCT-2013		6.8
I-40	6 M	07-NOV-2013		4.0
I-40	6 M	05-DEC-2013		7.4
I-40	9 M	09-JAN-2013		8.4
I-40	9 M	06-FEB-2013		17.3
I-40	9 M	12-MAR-2013		9.6
I-40	9 M	04-APR-2013		7.6
I-40	9 M	09-MAY-2013		13.0
I-40	9 M	05-JUN-2013		8.4
I-40	9 M	10-JUL-2013		18.2
I-40	9 M	21-AUG-2013		7.3
I-40	9 M	05-SEP-2013		3.8
I-40	9 M	01-OCT-2013		9.0
I-40	9 M	07-NOV-2013		5.5
I-40	9 M	05-DEC-2013		9.1

ND=not detected

## VI. Annual Pretreatment Program Data

### 2013 Annual Pretreatment Program Sludge Analysis (QUARTERLY SLUDGE PROJECT)

#### SOUTH BAY WATER RECLAMATION PLANT

Order No. R9-2013-0006

NPDES Permit No.CA0109045

The Quarterly Sludge Project is part of the South Bay WRP NPDES (Permit No. CA0109045/ Order No. R9-2013-0006) monitoring requirements for the Metropolitan Sewerage System. The sampling plan is designed so as to provide a “snapshot” of all of the physical and chemical characteristics monitored of the wastewater treatment waste streams for a short interval of time (1-2 days). This is conducted quarterly.

The Quarterly Sludge Project was conducted four times during 2013. Sampling occurred on February 5, May 7, August 6, and October 1. Monthly composite samples of MBC dewatered sludge (belt-press dewatered) during the respective calendar months were taken and analyzed for a similar suite of parameters. The tables showing the results of these analyses follow in this section. Results relative to the Pt. Loma WWTP or North City Water Reclamation Plant are in the respective annual reports for those facilities.

\* pH, Grease & Oils, temperature, and conductivity are determined from grab samples.

#### Abbreviations:

SB_INF_02	SBWRP influent
SB_OUTFALL_01	SBWRP effluent
SB_ITP_COMB_EFF	SBWRP & IWTP combined effluent
SB_REC_WATER_34	SBWRP reclaim water
SB_PRIEFF_10	Primary Effluent
SB_SEC_EFF_29	Secondary effluent
SB_RSL_10	Primary Sed Tank to Sludge Line

This page left blank intentionally

SOUTH BAY WATER RECLAMATION PLANT  
Daily Parameters and Metals

Annual 2013

Source: Date: Analyte	MDL Units	INFLUENT 05-FEB-2013	INFLUENT 07-MAY-2013	INFLUENT 06-AUG-2013	INFLUENT 01-OCT-2013
Aluminum	47 UG/L	1060	968	771	712
Antimony	2.9 UG/L	ND	ND	ND	6.1
Arsenic	.4 UG/L	0.7	1.1	1.3	0.9
Barium	.039 UG/L	68.8	100	90.3	87.0
Beryllium	.022 UG/L	ND	ND	ND	0.06
Boron	7 UG/L	269	299	281	263
Cadmium	.53 UG/L	ND	ND	ND	ND
Chromium	1.2 UG/L	2.9	3.3	4.8	3.1
Cobalt	.85 UG/L	ND	ND	ND	ND
Copper	2 UG/L	94	109	95	97
Iron	37 UG/L	625	1010	683	584
Lead	2 UG/L	3	ND	3	ND
Manganese	.24 UG/L	83.4	107	68.7	75.6
Mercury	.005 UG/L	0.096#	0.1	0.152	0.109
Molybdenum	.89 UG/L	6.27	6.99	8.86	5.64
Nickel	.53 UG/L	5.21	7.93	11.90	7.69
Selenium	.28 UG/L	1.32	1.60	1.73	1.72
Silver	.4 UG/L	0.5	0.5	0.8	ND
Thallium	3.9 UG/L	ND	ND	ND	10.4
Vanadium	.64 UG/L	2.22	2.40	ND	2.11
Zinc	2.5 UG/L	141	217	188	172
Calcium Hardness	.1 MG/L	168	214	154	146
Magnesium Hardness	.4 MG/L	145	127	122	102
Total Hardness	.4 MG/L	313	280	276	248
Total Alkalinity (bicarbonate)	20 MG/L	356	376	367	365
Calcium	.04 MG/L	67.4	69.4	61.8	58.5
Lithium	.002 MG/L	0.022	0.030	0.034	0.039
Magnesium	.1 MG/L	35.1	35.0	29.6	24.7
Potassium	.3 MG/L	19.2	20.8	21.3	17.0
Sodium	1 MG/L	207	214	184	164
Bromide	.1 MG/L	0.5	0.4	0.3	0.1
Chloride	7 MG/L	272	265	239	210
Fluoride	.05 MG/L	0.30	0.33	0.35	ND
Nitrate	.04 MG/L	0.12	0.08	0.08	0.11
Ortho Phosphate	.2 MG/L	10.6	11.2	11.5	11.8
Sulfate	9 MG/L	116	126	142	134
Cyanide, Total	.002 MG/L	ND	ND	ND	ND
BOD	2 MG/L	292	305	324	318
pH	PH	7.78	7.70	7.85	7.46
Settleable Solids	.1 ML/L	21.0	21.0	21.0	12.0
Turbidity	.13 NTU	135	164	157	171
Total Kjeldahl Nitrogen	1.6 MG/L	56.0	55.3	58.3	60.0
Ammonia-N	.3 MG/L	31.9	35.6	37.4	39.1
Sulfides-Total	.4 MG/L	1.97	4.95	4.38	6.19
Total Suspended Solids	1.4 MG/L	268	230	292	238
Volatile Suspended Solids	1.6 MG/L	242	208	260	210
Total Dissolved Solids	28 MG/L	1050	1030	1120	1010
MBAS (Surfactants)	.03 MG/L	10.5	9.92	11.0	10.1

#= this element was analyzed using method CVAF\_1613E where the MDL is 0.0005 UG/L.

ND= Not Detected  
NR= Not Required

Chromium results are for Total Chromium.

SOUTH BAY WATER RECLAMATION PLANT  
Daily Parameters and Metals

Annual 2013

Source: Date: Analyte	MDL Units	EFFLUENT 05-FEB-2013	EFFLUENT 07-MAY-2013	EFFLUENT 06-AUG-2013	EFFLUENT 01-OCT-2013
Aluminum	47 UG/L	81	119	95	<47
Antimony	2.9 UG/L	ND	ND	ND	ND
Arsenic	.4 UG/L	0.5	0.7	0.7	0.6
Barium	.039 UG/L	47.3	62.7	59.0	61.6
Beryllium	.022 UG/L	ND	ND	ND	ND
Boron	7 UG/L	301	340	292	286
Cadmium	.53 UG/L	ND	ND	ND	ND
Chromium	1.2 UG/L	ND	<1.2	ND	2.8
Cobalt	.85 UG/L	ND	ND	ND	ND
Copper	2 UG/L	13	12	10	9
Iron	37 UG/L	104	80	73	64
Lead	2 UG/L	2	ND	ND	ND
Manganese	.24 UG/L	25.3	18.1	36.4	14.7
Mercury	.005 UG/L	0.002#	ND	0.006	ND
Molybdenum	.89 UG/L	5.20	3.34	6.12	2.65
Nickel	.53 UG/L	4.66	5.79	4.43	6.48
Selenium	.28 UG/L	0.39	0.59	0.69	0.65
Silver	.4 UG/L	ND	ND	ND	ND
Thallium	3.9 UG/L	ND	ND	ND	ND
Vanadium	.64 UG/L	ND	0.77	ND	0.85
Zinc	2.5 UG/L	37.0	44.4	32.8	41.7
Calcium Hardness	.1 MG/L	161	224	166	160
Magnesium Hardness	.4 MG/L	133	126	119	107
Total Hardness	.4 MG/L	293	280	285	267
Total Alkalinity (bicarbonate)	20 MG/L	192	195	171	165
Calcium	.04 MG/L	64.3	73.6	65.8	64.2
Lithium	.002 MG/L	0.021	0.021	0.032	0.035
Magnesium	.1 MG/L	32.2	35.3	28.8	26.0
Potassium	.3 MG/L	16.6	20.0	18.4	16.3
Sodium	1 MG/L	193	226	181	173
Bromide	.1 MG/L	0.5	0.5	0.3	0.2
Chloride	7 MG/L	273	276	236	221
Fluoride	.05 MG/L	0.58	<0.05	0.51	0.50
Nitrate	.04 MG/L	29.1	39.0	28.0	34.6
Ortho Phosphate	.2 MG/L	4.2	3.1	5.8	7.7
Sulfate	9 MG/L	139	159	185	182
Cyanide, Total	.002 MG/L	ND	ND	0.002	ND
BOD	2 MG/L	13	7	8	8
pH	PH	7.31	7.42	7.36	7.34
Settleable Solids	.1 ML/L	ND	ND	ND	ND
Turbidity	.13 NTU	2.04	3.16	1.83	2.69
Total Kjeldahl Nitrogen	1.6 MG/L	5.6	2.1	NA	2.5
Chlorine Residual, Total	.03 MG/L	0.09	0.05	0.06	ND
Ammonia-N	.3 MG/L	1.7	ND	ND	ND
Sulfides-Total	.4 MG/L	ND	ND	ND	ND
Total Suspended Solids	1.4 MG/L	4.2	5.7	4.1	5.9
Volatile Suspended Solids	1.6 MG/L	3.6	5.1	3.5	4.8
Total Dissolved Solids	28 MG/L	930	1080	1160	960
MBAS (Surfactants)	.03 MG/L	0.21	0.06	0.05	0.12

#= This element was analyzed using method CVAF\_1613E where the MDL is 0.0005 UG/L.

ND= Not Detected

NA= Not Analyzed

Chromium results are for Total Chromium.

SOUTH BAY WATER RECLAMATION PLANT  
Daily Parameters and Metals

Annual 2013

Source:		COMB EFF	COMB EFF	COMB EFF	COMB EFF
Date:		05-FEB-2013	09-MAY-2013	06-AUG-2013	01-OCT-2013
Analyte	MDL Units				
Aluminum	47 UG/L	118	171	106	ND
Antimony	2.9 UG/L	ND	3.2	ND	6.8
Arsenic	.4 UG/L	1.2	1.0	1.8	2.5
Barium	.039 UG/L	22.7	28.9	24.2	21.2
Beryllium	.022 UG/L	ND	ND	ND	0.03
Boron	7 UG/L	300	531	456	463
Cadmium	.53 UG/L	ND	ND	ND	ND
Chromium	1.2 UG/L	1.3	1.7	ND	2.6
Cobalt	.85 UG/L	0.98	ND	ND	ND
Copper	2 UG/L	11	7	7	4
Iron	37 UG/L	302	258	181	192
Lead	2 UG/L	3	ND	ND	ND
Manganese	.24 UG/L	52.7	144	57.3	36.0
Mercury	.005 UG/L	ND	ND	0.015	ND
Molybdenum	.89 UG/L	6.56	9.79	8.27	7.24
Nickel	.53 UG/L	11.6	22.1	12.3	31.5
Selenium	.28 UG/L	1.27	1.59	1.16	1.76
Silver	.4 UG/L	ND	ND	ND	ND
Thallium	3.9 UG/L	ND	ND	ND	ND
Vanadium	.64 UG/L	1.23	0.84	1.10	2.09
Zinc	2.5 UG/L	43.1	48.0	21.2	25.7
Calcium Hardness	.1 MG/L	241	290	211	201
Magnesium Hardness	.4 MG/L	171	150	154	152
Total Hardness	.4 MG/L	411	330	365	353
Total Alkalinity (bicarbonate)	20 MG/L	188	162	177	147
Calcium	.04 MG/L	96.3	94.9	84.7	80.5
Lithium	.002 MG/L	0.057	0.059	0.070	0.067
Magnesium	.1 MG/L	41.4	40.5	37.3	36.9
Potassium	.3 MG/L	23.6	27.0	24.3	21.6
Sodium	1 MG/L	281	290	280	273
Bromide	.1 MG/L	0.4	0.4	0.3	0.2
Chloride	7 MG/L	316	355	338	347
Fluoride	.05 MG/L	0.48	0.57	0.59	0.65
Nitrate	.04 MG/L	34.8	53.6	18.8	69.6
Ortho Phosphate	.2 MG/L	11.7	7.6	8.1	13.9
Sulfate	9 MG/L	313	306	339	359
Cyanide, Total	.002 MG/L	0.004	0.006	0.004	0.003
BOD	2 MG/L	35	12	9	6
Ph	PH	7.31	7.46^	7.62	7.69
Settleable Solids	.1 ML/L	ND	0.3^	ND	ND
Turbidity	.13 NTU	3.76	2.06	2.48	1.94
Total Kjeldahl Nitrogen	1.6 MG/L	7.4	2.7	4.4*	2.4
Chlorine Residual, Total	.03 MG/L	ND	0.05^	0.07	0.26
Ammonia-N	.3 MG/L	1.4	0.6	2.9#	ND
Sulfides-Total	.4 MG/L	ND	ND	ND	ND
Total Suspended Solids	1.4 MG/L	10.5	5.3	5.1	5.3
Volatile Suspended Solids	1.6 MG/L	8.8	4.7	3.9	4.5
Total Dissolved Solids	28 MG/L	1330	1630	1600	1520
MBAS (Surfactants)	.03 MG/L	0.63	0.23	0.14	0.20

^= These analytes were sampled on May 7, 2013.  
 \*= This analyte was sampled on August 25, 2013.  
 #= This is the average of two different dates.  
 ND= Not Detected

Chromium results are for Total Chromium.

SOUTH BAY WATER RECLAMATION PLANT  
Daily Parameters and Metals

Annual 2013

Source:		PRI EFF	PRI EFF	PRI EFF	PRI EFF
Date:		05-FEB-2013	07-MAY-2013	06-AUG-2013	01-OCT-2013
Analyte	MDL Units				
Aluminum	47 UG/L	472	362	803	348
Antimony	2.9 UG/L	ND	ND	ND	4.9
Arsenic	.4 UG/L	0.5	0.9	0.8	0.7
Barium	.039 UG/L	65.8	74.1	168	74.1
Beryllium	.022 UG/L	ND	ND	ND	0.04
Boron	7 UG/L	278	303	639	276
Cadmium	.53 UG/L	ND	ND	0.81	ND
Chromium	1.2 UG/L	2.1	ND	4.9	3.9
Cobalt	.85 UG/L	ND	ND	ND	ND
Copper	2 UG/L	92	64	141	61
Iron	37 UG/L	466	388	880	381
Lead	2 UG/L	ND	ND	2	ND
Manganese	.24 UG/L	88.7	89.2	127	57.8
Mercury	.005 UG/L	0.01	0.014	0.056	0.048
Molybdenum	.89 UG/L	5.89	5.27	15.50	5.15
Nickel	.53 UG/L	4.58	5.62	12.20	8.17
Selenium	.28 UG/L	0.79	1.07	1.01	1.19
Silver	.4 UG/L	ND	ND	0.8	0.4
Thallium	3.9 UG/L	ND	ND	ND	9.4
Vanadium	.64 UG/L	1.64	1.23	2.10	1.65
Zinc	2.5 UG/L	111	101	268	94.1
Calcium Hardness	.1 MG/L	159	221	165	157
Magnesium Hardness	.4 MG/L	137	145	127	109
Total Hardness	.4 MG/L	296	323	292	266
Total Alkalinity (bicarbonate)	20 MG/L	334	333	321	309
Calcium	.04 MG/L	63.5	70.1	66.1	62.9
Lithium	.002 MG/L	0.023	0.028	0.036	0.035
Magnesium	.1 MG/L	33.3	34.9	30.7	26.4
Potassium	.3 MG/L	19.6	20.4	21.1	17.7
Sodium	1 MG/L	201	221	203	179
Bromide	.1 MG/L	0.4	0.4	0.3	0.2
Chloride	7 MG/L	266	275	276	222
Fluoride	.05 MG/L	0.30	0.49	0.36	0.54
Nitrate	.04 MG/L	0.13	2.36	0.06	0.09
Ortho Phosphate	.2 MG/L	12.4	9.9	9.1	7.9
Sulfate	9 MG/L	116	167	158	191
Cyanide, Total	.002 MG/L	ND	ND	ND	ND
BOD	2 MG/L	247	153	191	113
pH	PH	7.89	7.74	7.85	7.61
Settleable Solids	.1 ML/L	4.5	1.8	0.7	0.6
Turbidity	.13 NTU	67.9	65.0	102	65.5
Total Kjeldahl Nitrogen	1.6 MG/L	62.8	46.0	45.6	48.1
Ammonia-N	.3 MG/L	32.0	30.0	30.8	30.6
Sulfides-Total	.4 MG/L	0.87	ND	1.09	1.04
Total Suspended Solids	1.4 MG/L	70.0	76.0	98.0	94.0
Volatile Suspended Solids	1.6 MG/L	62.5	68.0	86.0	78.0
Total Dissolved Solids	28 MG/L	1030	1010	1190	990
MBAS (Surfactants)	.03 MG/L	7.80	5.10	5.89	4.28

ND= Not Detected

Chromium results are for Total Chromium.



SOUTH BAY WATER RECLAMATION PLANT  
Daily Parameters and Metals

Annual 2013

Source:		SEC_EFF	SEC_EFF	SEC_EFF	SEC_EFF
Date:		05-FEB-2013	07-MAY-2013	06-AUG-2013	01-OCT-2013
Analyte	MDL Units				
Aluminum	47 UG/L	81	128	113	52
Antimony	2.9 UG/L	ND	ND	ND	6.3
Arsenic	.4 UG/L	0.5	0.7	0.8	0.7
Barium	.039 UG/L	47.6	62.6	59.4	58.3
Beryllium	.022 UG/L	ND	ND	ND	0.04
Boron	7 UG/L	293	341	301	279
Cadmium	.53 UG/L	ND	ND	ND	ND
Chromium	1.2 UG/L	ND	ND	ND	2.3
Cobalt	.85 UG/L	ND	ND	ND	ND
Copper	2 UG/L	12	10	12	7
Iron	37 UG/L	65	73	75	88
Lead	2 UG/L	ND	ND	ND	ND
Manganese	.24 UG/L	26.9	17.7	33.4	12.3
Mercury	.005 UG/L	ND	0.014	0.013	0.005
Molybdenum	.89 UG/L	4.96	2.60	5.53	2.72
Nickel	.53 UG/L	4.69	4.66	5.47	6.05
Selenium	.28 UG/L	0.40	0.66	0.91	0.64
Silver	.4 UG/L	ND	ND	ND	ND
Thallium	3.9 UG/L	ND	4.2	ND	ND
Vanadium	.64 UG/L	0.83	0.72	ND	1.22
Zinc	2.5 UG/L	34.8	38.3	33.8	39.8
Calcium Hardness	.1 MG/L	179	215	164	157
Magnesium Hardness	.4 MG/L	145	149	120	107
Total Hardness	.4 MG/L	325	333	284	264
Total Alkalinity (bicarbonate)	20 MG/L	188	195	169	163
Calcium	.04 MG/L	71.9	71.6	65.6	63.0
Lithium	.002 MG/L	0.022	0.024	0.032	0.034
Magnesium	.1 MG/L	35.2	33.9	29.2	25.9
Potassium	.3 MG/L	18.3	18.3	18.7	16.7
Sodium	1 MG/L	212	215	183	176
Bromide	.1 MG/L	0.5	0.5	0.3	0.2
Chloride	7 MG/L	275	276	236	221
Fluoride	.05 MG/L	0.58	0.53	0.57	0.49
Nitrate	.04 MG/L	26.2	39.0	32.8	36.4
Ortho Phosphate	.2 MG/L	3.6	3.2	5.6	8.1
Sulfate	9 MG/L	140	157	191	183
Cyanide, Total	.002 MG/L	ND	ND	ND	ND
BOD	2 MG/L	20	7	13	6
pH	PH	7.41	7.50	7.52	7.46
Settleable Solids	.1 ML/L	0.1	ND	0.1	ND
Total Kjeldahl Nitrogen	1.6 MG/L	6.7	2.5	3.5	2.6
Ammonia-N	.3 MG/L	1.9	ND	0.9	ND
Sulfides-Total	.4 MG/L	ND	ND	ND	ND
Total Suspended Solids	1.4 MG/L	6.3	6.4	7.3	5.8
Volatile Suspended Solids	1.6 MG/L	5.7	5.6	5.0	4.9
Total Dissolved Solids	28 MG/L	910	1090	1130	990
MBAS (Surfactants)	.03 MG/L	0.23	0.08	0.03	0.11

ND= Not Detected

Chromium results are for Total Chromium.

SOUTH BAY WATER RECLAMATION PLANT  
Daily Parameters and Metals

Annual 2013

Source: Date: Analyte	MDL Units	RAW SLUDGE 05-FEB-2013	RAW SLUDGE 07-MAY-2013	RAW SLUDGE 06-AUG-2013	RAW SLUDGE 01-OCT-2013
Aluminum	47 UG/L	20300	37500	63300	31700
Antimony	2.9 UG/L	13.5	24.3	31.5	24.1
Arsenic	.4 UG/L	11.0	17.2	7.9	10.5
Barium	.039 UG/L	610	1700	2910	1000
Beryllium	.022 UG/L	0.196	ND	ND	0.38
Boron	7 UG/L	154	456	1060	308
Cadmium	.53 UG/L	2.55	6.71	13.70	6.09
Chromium	1.2 UG/L	104	322	286	122
Cobalt	.85 UG/L	5.62	18.4	28.8	13.7
Copper	2 UG/L	1430	3140	5260	2290
Iron	37 UG/L	19800	79700	67400	29800
Lead	2 UG/L	415	391	265	98
Manganese	.24 UG/L	457	1270	1630	860
Mercury	.005 UG/L	31.3	13.3	1.71	43.2
Molybdenum	.89 UG/L	30.5	101	175	55.7
Nickel	.53 UG/L	91	294	358	116
Selenium	.28 UG/L	26.1	25.9	15.1	21.8
Silver	.4 UG/L	22.9	49.8	49.9	27.6
Thallium	3.9 UG/L	7.9	13.2	11.2	29.3
Vanadium	.64 UG/L	33.4	105	125	49.1
Zinc	2.5 UG/L	2310	6180	11800	3930
Calcium Hardness	.1 MG/L	NR	NR	NR	206
Magnesium Hardness	.4 MG/L	NR	NR	NR	126
Total Hardness	.4 MG/L	NR	NR	NR	332
Total Alkalinity (bicarbonate)	20 MG/L	836	895	652	753
Calcium	.04 MG/L	91.0	102	73.2	82.3
Lithium	.002 MG/L	0.023	0.023	0.036	0.030
Magnesium	.1 MG/L	40.9	41.8	32.9	30.5
Potassium	.3 MG/L	29.1	34.0	28.7	24.9
Sodium	1 MG/L	215	212	196	171
Bromide	.1 MG/L	0.4	0.3	0.3	ND
Chloride	7 MG/L	270	275	248	218
Fluoride	.05 MG/L	0.20	ND	ND	ND
Nitrate	.04 MG/L	0.10	0.10	ND	0.06
Ortho Phosphate	.2 MG/L	39.3	41.3	23.9	26.9
Sulfate	9 MG/L	32	17	40	33
Cyanide, Total	.002 MG/L	0.003	0.004	ND	ND
Total Kjeldahl Nitrogen	1.6 MG/L	369	421	247	346
Sulfides-Total	.4 MG/L	30.2	41.2	39.3	46.0

ND= Not Detected  
NR= Not Required

Chromium results are for Total Chromium.

SOUTH BAY WATER RECLAMATION PLANT  
Daily Parameters and Metals

Annual 2013

Source: Date: Analyte	MDL Units	REC_WATER 05-FEB-2013	REC_WATER 07-MAY-2013	REC_WATER 06-AUG-2013	REC_WATER 01-OCT-2013
Aluminum	47 UG/L	74	117	95	ND
Antimony	2.9 UG/L	ND	ND	ND	ND
Arsenic	.4 UG/L	0.6	0.8	0.8	0.7
Barium	.039 UG/L	45.2	60.4	59.2	59.1
Beryllium	.022 UG/L	ND	ND	ND	ND
Boron	7 UG/L	289	331	289	282
Cadmium	.53 UG/L	ND	ND	ND	ND
Chromium	1.2 UG/L	ND	ND	ND	2.2
Cobalt	.85 UG/L	ND	ND	ND	ND
Copper	2 UG/L	10	9	8	7
Iron	37 UG/L	64	85	49	53
Lead	2 UG/L	ND	ND	ND	ND
Manganese	.24 UG/L	22.9	8.5	34.8	6.92
Mercury	.005 UG/L	ND	ND	ND	ND
Molybdenum	.89 UG/L	5.36	2.13	5.21	2.52
Nickel	.53 UG/L	5.59	4.06	5.46	6.38
Selenium	.28 UG/L	0.34	0.59	0.65	0.53
Silver	.4 UG/L	ND	ND	ND	<0.4
Thallium	3.9 UG/L	ND	5.2	ND	ND
Vanadium	.64 UG/L	1.10	0.69	ND	<0.64
Zinc	2.5 UG/L	33.6	38.9	31.4	36.8
Calcium Hardness	.1 MG/L	171	212	167	169
Magnesium Hardness	.4 MG/L	144	123	121	114
Total Hardness	.4 MG/L	315	319	288	283
Total Alkalinity (bicarbonate)	20 MG/L	197	194	176	165
Calcium	.04 MG/L	68.6	69.0	65.8	67.6
Lithium	.002 MG/L	0.021	0.022	0.032	0.033
Magnesium	.1 MG/L	35.0	33.0	29.3	27.7
Potassium	.3 MG/L	18.2	18.0	18.7	17.5
Sodium	1 MG/L	207	212	182	187
Bromide	.1 MG/L	0.5	0.4	0.3	0.2
Chloride	7 MG/L	276	282	238	223
Fluoride	.05 MG/L	0.55	0.54	0.58	0.49
Nitrate	.04 MG/L	25.8	36.2	24.8	37.4
Ortho Phosphate	.2 MG/L	4.5	3.1	6.0	7.9
Sulfate	9 MG/L	142	158	191	182
Cyanide, Total	.002 MG/L	0.002	0.003	0.525	0.003
BOD	2 MG/L	4	ND	ND	ND
pH	PH	7.38	7.45	7.39	7.35
Turbidity	.13 NTU	1.34	0.72	1.17	0.62
Total Kjeldahl Nitrogen	1.6 MG/L	5.3	ND	6.3	1.8
Ammonia-N	.3 MG/L	1.6	ND	ND	ND
Sulfides-Total	.4 MG/L	ND	ND	ND	0.56
Total Suspended Solids	1.4 MG/L	1.8	ND	ND	ND
Volatile Suspended Solids	1.6 MG/L	1.6	ND	ND	ND
Total Dissolved Solids	28 MG/L	910	1060	1150	950
MBAS (Surfactants)	.03 MG/L	0.06	0.07	0.05	0.11

ND= Not Detected

Chromium results are for Total Chromium.

SOUTH BAY WATER RECLAMATION PLANT  
Ammonia-Nitrogen and Total Cyanides

Annual 2013

Total Cyanide, MDL=0.002 mg/L

Source:	INFLUENT	EFFLUENT	COMB EFF	PRI EFF	SEC EFF	RSL
05-FEB-2013	ND	ND	0.004	ND	ND	0.003
07-MAY-2013	ND	ND	NR	ND	ND	0.004
09-MAY-2013	NR	NR	0.006	NR	NR	NR
06-AUG-2013	ND	0.002	0.004	ND	ND	ND
01-OCT-2013	ND	ND	0.003	ND	ND	ND
AVERAGE	ND	0.001	0.004	ND	ND	0.002

Ammonia as Nitrogen, MDL=0.3 mg/L

Source:	INFLUENT	EFFLUENT	COMB EFF	PRI EFF	SEC EFF
05-FEB-2013	31.9	1.7	1.4	32.0	1.9
07-MAY-2013	35.6	ND	NR	30.0	ND
09-MAY-2013	NR	NR	0.6	NR	NR
06-AUG-2013	37.4	ND	3.2	30.8	0.9
25-AUG-2013	NR	NR	2.5	NR	NR
01-OCT-2013	39.1	ND	ND	30.6	ND
AVERAGE	36.0	0.4	1.5	30.9	0.7

ND= Not Detected  
NR= Not Required

SOUTH BAY WATER RECLAMATION PLANT  
Radioactivity

Analyzed by: TestAmerica Laboratories Richland

Annual 2013

Source	Sample Date	Sample ID	Gross Alpha Radiation	Gross Beta Radiation
INFLUENT	05-FEB-2013	P649723	0.8 ± 4.6	17.6 ± 6.1
INFLUENT	07-MAY-2013	P661191	7.9 ± 7.9	18.5 ± 8.0
INFLUENT	06-AUG-2013	P671198	8.9 ± 8.2	22.3 ± 9.4
INFLUENT	01-OCT-2013	P677738	9.3 ± 5.7	22.0 ± 6.6
AVERAGE			6.7 ± 6.6	20.1 ± 7.5

Source	Sample Date	Sample ID	Gross Alpha Radiation	Gross Beta Radiation
EFFLUENT	05-FEB-2013	P649728	0.9 ± 4.9	18.6 ± 4.9
EFFLUENT	07-MAY-2013	P661196	1.5 ± 7.0	28.1 ± 8.2
EFFLUENT	06-AUG-2013	P671203	1.2 ± 4.8	14.3 ± 5.8
EFFLUENT	01-OCT-2013	P677743	-0.1 ± 4.5	21.7 ± 6.5
AVERAGE			0.9 ± 5.3	20.7 ± 6.4

Source	Sample Date	Sample ID	Gross Alpha Radiation	Gross Beta Radiation
COMB EFF	05-FEB-2013	P649733	2.8 ± 6.4	33.1 ± 7.8
COMB EFF	09-MAY-2013	P661201	5.6 ± 8.3	23.9 ± 9.5
COMB EFF	06-AUG-2013	P671208	1.6 ± 7.9	19.5 ± 8.9
COMB EFF	01-OCT-2013	P677748	-2.1 ± 5.9	31.0 ± 8.1
AVERAGE			2.0 ± 7.1	26.9 ± 8.6

Source	Sample Date	Sample ID	Gross Alpha Radiation	Gross Beta Radiation
PRI EFF	05-FEB-2013	P649738	2.0 ± 4.9	27.5 ± 5.7
PRI EFF	07-MAY-2013	P661206	-4.5 ± 5.8	17.8 ± 8.4
PRI EFF	06-AUG-2013	P671213	0.6 ± 4.8	20.4 ± 6.7
PRI EFF	01-OCT-2013	P677753	3.3 ± 4.1	21.1 ± 5.1
AVERAGE			0.4 ± 4.9	21.7 ± 6.5

Source	Sample Date	Sample ID	Gross Alpha Radiation	Gross Beta Radiation
SEC EFF	05-FEB-2013	P649743	2.1 ± 4.0	25.2 ± 5.7
SEC EFF	07-MAY-2013	P661211	0.7 ± 5.7	19.7 ± 7.9
SEC EFF	06-AUG-2013	P671218	-3.5 ± 4.1	17.1 ± 5.2
SEC EFF	01-OCT-2013	P677758	3.4 ± 3.6	19.5 ± 5.3
AVERAGE			0.7 ± 4.4	20.4 ± 6.0

Source	Sample Date	Sample ID	Gross Alpha Radiation	Gross Beta Radiation
REC WATER	05-FEB-2013	P649759	2.1 ± 4.7	20.5 ± 5.7
REC WATER	07-MAY-2013	P661225	-5.9 ± 5.7	21.7 ± 8.1
REC WATER	06-AUG-2013	P671234	3.1 ± 5.6	15.0 ± 6.2
REC WATER	01-OCT-2013	P677772	1.9 ± 4.6	18.6 ± 5.4
AVERAGE			0.3 ± 5.2	19.0 ± 6.4

ND= Not Detected

Units in picocuries/liter (pCi/L)

SOUTH BAY WATER RECLAMATION PLANT  
Chlorinated Pesticide Analysis, EPA Method 608 (with additions)

Annual 2013

Source:			INFLUENT	INFLUENT	INFLUENT	INFLUENT
Date:			05-FEB-2013	07-MAY-2013	06-AUG-2013	01-OCT-2013
Analyte	MDL	Units	P649723	P661191	P671198	P677738
=====	=====	=====	=====	=====	=====	=====
Aldrin	8	NG/L	ND	ND	ND	ND
BHC, Alpha isomer	15	NG/L	ND	ND	ND	ND
BHC, Beta isomer	20	NG/L	ND	ND	ND	ND
BHC, Delta isomer	18	NG/L	ND	ND	ND	ND
BHC, Gamma isomer	15	NG/L	ND	ND	ND	ND
Alpha (cis) Chlordane	2	NG/L	ND	ND	ND	ND
Gamma (trans) Chlordane	2	NG/L	ND	ND	ND	ND
Alpha Chlordene		NG/L	NA	NA	NA	NA
Gamma Chlordene		NG/L	NA	NA	NA	NA
Cis Nonachlor	5	NG/L	ND	ND	NA	ND
Dieldrin	10	NG/L	ND	ND	ND	ND
Endosulfan Sulfate	15	NG/L	ND	ND	ND	ND
Alpha Endosulfan	15	NG/L	ND	ND	ND	ND
Beta Endosulfan	10	NG/L	ND	ND	ND	ND
Endrin	10	NG/L	ND	ND	ND	ND
Endrin aldehyde	10	NG/L	ND	ND	ND	ND
Heptachlor	15	NG/L	ND	ND	ND	ND
Heptachlor epoxide	13	NG/L	ND	ND	ND	ND
Methoxychlor	18	NG/L	ND	ND	ND	ND
Mirex	10	NG/L	ND	ND	ND	ND
o,p-DDD	100	NG/L	ND	ND	ND	ND
o,p-DDE	100	NG/L	ND	ND	ND	ND
o,p-DDT	100	NG/L	ND	ND	ND	ND
Oxychlordane	3	NG/L	ND	ND	NA	ND
PCB 1016	1300	NG/L	ND	ND	ND	ND
PCB 1221	1300	NG/L	ND	ND	ND	ND
PCB 1232	1300	NG/L	ND	ND	ND	ND
PCB 1242	1300	NG/L	ND	ND	ND	ND
PCB 1248	1300	NG/L	ND	ND	ND	ND
PCB 1254	1300	NG/L	ND	ND	ND	ND
PCB 1260	1300	NG/L	ND	ND	ND	ND
PCB 1262	1300	NG/L	ND	ND	ND	ND
p,p-DDD	20	NG/L	ND	ND	ND	ND
p,p-DDE	15	NG/L	DNQ3	ND	ND	DNQ4
p,p-DDT	20	NG/L	ND	ND	ND	ND
Toxaphene	1300	NG/L	ND	ND	ND	ND
Trans Nonachlor	3	NG/L	ND	ND	NA	ND
=====	=====	=====	=====	=====	=====	=====
Aldrin + Dieldrin	10	NG/L	0	0	0	0
Hexachlorocyclohexanes	20	NG/L	0	0	0	0
DDT and derivatives	100	NG/L	3	0	0	4
Chlordane + related cmpds.	5	NG/L	0	0	0	0
Polychlorinated biphenyls	1300	NG/L	0	0	0	0
Endosulfans	15	NG/L	0	0	0	0
Heptachlors	15	NG/L	0	0	0	0
=====	=====	=====	=====	=====	=====	=====
Chlorinated Hydrocarbons	1300	NG/L	0	0	0	0

ND=not detected

NA=not analyzed

DNQ=Detected not quantifiable, result value less than minimum level (ML) but greater or equal MDL.

Standards for alpha and gamma chlordene are no longer available in the U.S. for the analysis of these compounds.

SOUTH BAY WATER RECLAMATION PLANT  
Chlorinated Pesticide Analysis, EPA Method 608 (with additions)

Annual 2013

Source:			EFFLUENT	EFFLUENT	EFFLUENT	EFFLUENT
Date:			05-FEB-2013	07-MAY-2013	06-AUG-2013	01-OCT-2013
Analyte	MDL	Units	P649728	P661196	P671203	P677743
=====	=====	=====	=====	=====	=====	=====
Aldrin	8	NG/L	ND	ND	ND	ND
BHC, Alpha isomer	15	NG/L	ND	ND	ND	ND
BHC, Beta isomer	20	NG/L	ND	ND	ND	ND
BHC, Delta isomer	18	NG/L	ND	ND	ND	ND
BHC, Gamma isomer	15	NG/L	ND	ND	ND	ND
Alpha (cis) Chlordane	2	NG/L	ND	ND	ND	ND
Gamma (trans) Chlordane	2	NG/L	ND	ND	ND	ND
Alpha Chlordene		NG/L	NA	NA	NA	NA
Gamma Chlordene		NG/L	NA	NA	NA	NA
Cis Nonachlor	5	NG/L	ND	ND	NA	ND
Dieldrin	10	NG/L	ND	ND	ND	ND
Endosulfan Sulfate	15	NG/L	ND	ND	ND	ND
Alpha Endosulfan	15	NG/L	ND	ND	ND	ND
Beta Endosulfan	10	NG/L	ND	ND	ND	ND
Endrin	10	NG/L	ND	ND	ND	ND
Endrin aldehyde	10	NG/L	ND	ND	ND	ND
Heptachlor	15	NG/L	ND	ND	ND	ND
Heptachlor epoxide	13	NG/L	ND	ND	ND	ND
Methoxychlor	18	NG/L	ND	ND	ND	ND
Mirex	10	NG/L	ND	ND	ND	ND
o,p-DDD	100	NG/L	ND	ND	ND	ND
o,p-DDE	100	NG/L	ND	ND	ND	ND
o,p-DDT	100	NG/L	ND	ND	ND	ND
Oxychlordane	3	NG/L	ND	ND	NA	ND
PCB 1016	1300	NG/L	ND	ND	ND	ND
PCB 1221	1300	NG/L	ND	ND	ND	ND
PCB 1232	1300	NG/L	ND	ND	ND	ND
PCB 1242	1300	NG/L	ND	ND	ND	ND
PCB 1248	1300	NG/L	ND	ND	ND	ND
PCB 1254	1300	NG/L	ND	ND	ND	ND
PCB 1260	1300	NG/L	ND	ND	ND	ND
PCB 1262	1300	NG/L	ND	ND	ND	ND
p,p-DDD	20	NG/L	ND	ND	ND	ND
p,p-DDE	15	NG/L	ND	ND	ND	ND
p,p-DDT	20	NG/L	ND	ND	ND	ND
Toxaphene	1300	NG/L	ND	ND	ND	ND
Trans Nonachlor	3	NG/L	ND	ND	NA	ND
=====	=====	=====	=====	=====	=====	=====
Aldrin + Dieldrin	10	NG/L	0	0	0	0
Hexachlorocyclohexanes	20	NG/L	0	0	0	0
DDT and derivatives	100	NG/L	0	0	0	0
Chlordane + related cmpds.	5	NG/L	0	0	0	0
Polychlorinated biphenyls	1300	NG/L	0	0	0	0
Endosulfans	15	NG/L	0	0	0	0
Heptachlors	15	NG/L	0	0	0	0
=====	=====	=====	=====	=====	=====	=====
Chlorinated Hydrocarbons	1300	NG/L	0	0	0	0

ND=not detected  
NA=not analyzed

Standards for alpha and gamma chlordene are no longer available in the U.S. for the analysis of these compounds.

SOUTH BAY WATER RECLAMATION PLANT  
Chlorinated Pesticide Analysis, EPA Method 608 (with additions)

Annual 2013

Source:			COMB EFF	COMB EFF	COMB EFF	COMB EFF
Date:			05-FEB-2013	09-MAY-2013	06-AUG-2013	01-OCT-2013
Analyte	MDL	Units	P649733	P661201	P671208	P677748
=====	=====	=====	=====	=====	=====	=====
Aldrin	8	NG/L	ND	ND	ND	ND
BHC, Alpha isomer	15	NG/L	ND	ND	ND	ND
BHC, Beta isomer	20	NG/L	ND	ND	ND	ND
BHC, Delta isomer	18	NG/L	ND	ND	ND	ND
BHC, Gamma isomer	15	NG/L	ND	ND	ND	ND
Alpha (cis) Chlordane	2	NG/L	ND	ND	ND	ND
Gamma (trans) Chlordane	2	NG/L	ND	ND	ND	ND
Alpha Chlordene		NG/L	NA	NA	NA	NA
Gamma Chlordene		NG/L	NA	NA	NA	NA
Cis Nonachlor	5	NG/L	ND	ND	NA	ND
Dieldrin	10	NG/L	ND	ND	ND	ND
Endosulfan Sulfate	15	NG/L	ND	ND	ND	ND
Alpha Endosulfan	15	NG/L	ND	ND	ND	ND
Beta Endosulfan	10	NG/L	ND	ND	ND	ND
Endrin	10	NG/L	ND	ND	ND	ND
Endrin aldehyde	10	NG/L	ND	ND	ND	ND
Heptachlor	15	NG/L	ND	ND	ND	ND
Heptachlor epoxide	13	NG/L	ND	ND	ND	ND
Methoxychlor	18	NG/L	ND	ND	ND	ND
Mirex	10	NG/L	ND	ND	ND	ND
o,p-DDD	100	NG/L	ND	ND	ND	ND
o,p-DDE	100	NG/L	ND	ND	ND	ND
o,p-DDT	100	NG/L	ND	ND	ND	ND
Oxychlordane	3	NG/L	ND	ND	NA	ND
PCB 1016	1300	NG/L	ND	ND	ND	ND
PCB 1221	1300	NG/L	ND	ND	ND	ND
PCB 1232	1300	NG/L	ND	ND	ND	ND
PCB 1242	1300	NG/L	ND	ND	ND	ND
PCB 1248	1300	NG/L	ND	ND	ND	ND
PCB 1254	1300	NG/L	ND	ND	ND	ND
PCB 1260	1300	NG/L	ND	ND	ND	ND
PCB 1262	1300	NG/L	ND	ND	ND	ND
p,p-DDD	20	NG/L	ND	ND	ND	ND
p,p-DDE	15	NG/L	ND	ND	ND	ND
p,p-DDT	20	NG/L	ND	ND	ND	ND
Toxaphene	1300	NG/L	ND	ND	ND	ND
Trans Nonachlor	3	NG/L	ND	ND	NA	ND
=====	=====	=====	=====	=====	=====	=====
Aldrin + Dieldrin	10	NG/L	0	0	0	0
Hexachlorocyclohexanes	20	NG/L	0	0	0	0
DDT and derivatives	100	NG/L	0	0	0	0
Chlordane + related cmpds.	5	NG/L	0	0	0	0
Polychlorinated biphenyls	1300	NG/L	0	0	0	0
Endosulfans	15	NG/L	0	0	0	0
Heptachlors	15	NG/L	0	0	0	0
=====	=====	=====	=====	=====	=====	=====
Chlorinated Hydrocarbons	1300	NG/L	0	0	0	0

ND=not detected  
NA=not analyzed

Standards for alpha and gamma chlordene are no longer available in the U.S. for the analysis of these compounds.



SOUTH BAY WATER RECLAMATION PLANT  
Chlorinated Pesticide Analysis, EPA Method 608 (with additions)

Annual 2013

Source:			PRI EFF	PRI EFF	PRI EFF	PRI EFF
Date:			05-FEB-2013	07-MAY-2013	06-AUG-2013	01-OCT-2013
Analyte	MDL	Units	P649738	P661206	P671213	P677753
=====	=====	=====	=====	=====	=====	=====
Aldrin	8	NG/L	ND	ND	ND	ND
BHC, Alpha isomer	15	NG/L	ND	ND	ND	ND
BHC, Beta isomer	20	NG/L	ND	ND	ND	ND
BHC, Delta isomer	18	NG/L	ND	ND	ND	ND
BHC, Gamma isomer	15	NG/L	ND	ND	ND	ND
Alpha (cis) Chlordane	2	NG/L	ND	ND	ND	ND
Gamma (trans) Chlordane	2	NG/L	ND	ND	ND	ND
Alpha Chlordene		NG/L	NA	NA	NA	NA
Gamma Chlordene		NG/L	NA	NA	NA	NA
Cis Nonachlor	5	NG/L	ND	ND	NA	ND
Dieldrin	10	NG/L	ND	ND	ND	ND
Endosulfan Sulfate	15	NG/L	ND	ND	ND	ND
Alpha Endosulfan	15	NG/L	ND	ND	ND	ND
Beta Endosulfan	10	NG/L	ND	ND	ND	ND
Endrin	10	NG/L	ND	ND	ND	ND
Endrin aldehyde	10	NG/L	ND	ND	ND	ND
Heptachlor	15	NG/L	ND	ND	ND	ND
Heptachlor epoxide	13	NG/L	ND	ND	ND	ND
Methoxychlor	18	NG/L	ND	ND	ND	ND
Mirex	10	NG/L	ND	ND	ND	ND
o,p-DDD	100	NG/L	ND	ND	ND	ND
o,p-DDE	100	NG/L	ND	ND	ND	ND
o,p-DDT	100	NG/L	ND	ND	ND	ND
Oxychlordane	3	NG/L	ND	ND	NA	ND
PCB 1016	1300	NG/L	ND	ND	ND	ND
PCB 1221	1300	NG/L	ND	ND	ND	ND
PCB 1232	1300	NG/L	ND	ND	ND	ND
PCB 1242	1300	NG/L	ND	ND	ND	ND
PCB 1248	1300	NG/L	ND	ND	ND	ND
PCB 1254	1300	NG/L	ND	ND	ND	ND
PCB 1260	1300	NG/L	ND	ND	ND	ND
PCB 1262	1300	NG/L	ND	ND	ND	ND
p,p-DDD	20	NG/L	ND	ND	ND	ND
p,p-DDE	15	NG/L	DNQ3	ND	ND	DNQ2
p,p-DDT	20	NG/L	ND	ND	ND	ND
Toxaphene	1300	NG/L	ND	ND	ND	ND
Trans Nonachlor	3	NG/L	ND	ND	NA	ND
=====	=====	=====	=====	=====	=====	=====
Aldrin + Dieldrin	10	NG/L	0	0	0	0
Hexachlorocyclohexanes	20	NG/L	0	0	0	0
DDT and derivatives	100	NG/L	3	0	0	2
Chlordane + related cmpds.	5	NG/L	0	0	0	0
Polychlorinated biphenyls	1300	NG/L	0	0	0	0
Endosulfans	15	NG/L	0	0	0	0
Heptachlors	15	NG/L	0	0	0	0
=====	=====	=====	=====	=====	=====	=====
Chlorinated Hydrocarbons	1300	NG/L	0	0	0	0

ND=not detected

NA=not analyzed

DNQ=Detected not quantifiable, result value less than minimum level (ML) but greater or equal MDL.

Standards for alpha and gamma chlordene are no longer available in the U.S. for the analysis of these compounds.

SOUTH BAY WATER RECLAMATION PLANT  
Chlorinated Pesticide Analysis, EPA Method 608 (with additions)

Annual 2013

Source:			SEC EFF	SEC EFF	SEC EFF	SEC EFF
Date:			05-FEB-2013	07-MAY-2013	06-AUG-2013	01-OCT-2013
Analyte	MDL	Units	P649743	P661211	P671218	P677758
=====	=====	=====	=====	=====	=====	=====
Aldrin	8	NG/L	ND	ND	ND	ND
BHC, Alpha isomer	15	NG/L	ND	ND	ND	ND
BHC, Beta isomer	20	NG/L	ND	ND	ND	ND
BHC, Delta isomer	18	NG/L	ND	ND	ND	ND
BHC, Gamma isomer	15	NG/L	ND	ND	ND	ND
Alpha (cis) Chlordane	2	NG/L	ND	ND	ND	ND
Gamma (trans) Chlordane	2	NG/L	ND	ND	ND	ND
Alpha Chlordene		NG/L	NA	NA	NA	NA
Gamma Chlordene		NG/L	NA	NA	NA	NA
Cis Nonachlor	5	NG/L	ND	ND	NA	ND
Dieldrin	10	NG/L	ND	ND	ND	ND
Endosulfan Sulfate	15	NG/L	ND	ND	ND	ND
Alpha Endosulfan	15	NG/L	ND	ND	ND	ND
Beta Endosulfan	10	NG/L	ND	ND	ND	ND
Endrin	10	NG/L	ND	ND	ND	ND
Endrin aldehyde	10	NG/L	ND	ND	ND	ND
Heptachlor	15	NG/L	ND	ND	ND	ND
Heptachlor epoxide	13	NG/L	ND	ND	ND	ND
Methoxychlor	18	NG/L	ND	ND	ND	ND
Mirex	10	NG/L	ND	ND	ND	ND
o,p-DDD	100	NG/L	ND	ND	ND	ND
o,p-DDE	100	NG/L	ND	ND	ND	ND
o,p-DDT	100	NG/L	ND	ND	ND	ND
Oxychlordane	3	NG/L	ND	ND	NA	ND
PCB 1016	1300	NG/L	ND	ND	ND	ND
PCB 1221	1300	NG/L	ND	ND	ND	ND
PCB 1232	1300	NG/L	ND	ND	ND	ND
PCB 1242	1300	NG/L	ND	ND	ND	ND
PCB 1248	1300	NG/L	ND	ND	ND	ND
PCB 1254	1300	NG/L	ND	ND	ND	ND
PCB 1260	1300	NG/L	ND	ND	ND	ND
PCB 1262	1300	NG/L	ND	ND	ND	ND
p,p-DDD	20	NG/L	ND	ND	ND	ND
p,p-DDE	15	NG/L	ND	ND	ND	ND
p,p-DDT	20	NG/L	ND	ND	ND	ND
Toxaphene	1300	NG/L	ND	ND	ND	ND
Trans Nonachlor	3	NG/L	ND	ND	NA	ND
=====	=====	=====	=====	=====	=====	=====
Aldrin + Dieldrin	10	NG/L	0	0	0	0
Hexachlorocyclohexanes	20	NG/L	0	0	0	0
DDT and derivatives	100	NG/L	0	0	0	0
Chlordane + related cmpds.	5	NG/L	0	0	0	0
Polychlorinated biphenyls	1300	NG/L	0	0	0	0
Endosulfans	15	NG/L	0	0	0	0
Heptachlors	15	NG/L	0	0	0	0
=====	=====	=====	=====	=====	=====	=====
Chlorinated Hydrocarbons	1300	NG/L	0	0	0	0

ND=not detected  
NA=not analyzed

Standards for alpha and gamma chlordene are no longer available in the U.S. for the analysis of these compounds.

SOUTH BAY WATER RECLAMATION PLANT  
Chlorinated Pesticide Analysis, EPA Method 608 (with additions)

Annual 2013

Source:			RSL	RSL	RSL	RSL
Date:			05-FEB-2013	07-MAY-2013	06-AUG-2013	01-OCT-2013
Analyte	MDL	Units	P649757	P661223	P671232	P677770
=====	=====	=====	=====	=====	=====	=====
Aldrin	8	NG/L	ND	ND	ND	ND
BHC, Alpha isomer	15	NG/L	ND	ND	ND	ND
BHC, Beta isomer	20	NG/L	ND	ND	ND	ND
BHC, Delta isomer	18	NG/L	ND	ND	ND	ND
BHC, Gamma isomer	15	NG/L	ND	ND	ND	ND
Alpha (cis) Chlordane	2	NG/L	ND	ND	ND	ND
Gamma (trans) Chlordane	2	NG/L	ND	ND	ND	ND
Alpha Chlordene		NG/L	NA	NA	NA	NA
Gamma Chlordene		NG/L	NA	NA	NA	NA
Cis Nonachlor	5	NG/L	ND	ND	NA	ND
Dieldrin	10	NG/L	ND	ND	ND	ND
Endosulfan Sulfate	15	NG/L	ND	ND	ND	ND
Alpha Endosulfan	15	NG/L	ND	ND	ND	ND
Beta Endosulfan	10	NG/L	ND	ND	ND	ND
Endrin	10	NG/L	ND	ND	ND	ND
Endrin aldehyde	10	NG/L	ND	ND	ND	DNQ200
Heptachlor	15	NG/L	ND	ND	ND	ND
Heptachlor epoxide	13	NG/L	ND	ND	ND	ND
Methoxychlor	18	NG/L	ND	ND	ND	ND
Mirex	10	NG/L	ND	ND	ND	ND
o,p-DDD	100	NG/L	DNQ220	ND	ND	ND
o,p-DDE	100	NG/L	ND	ND	ND	DNQ17
o,p-DDT	100	NG/L	ND	ND	ND	ND
Oxychlordane	3	NG/L	ND	ND	NA	ND
PCB 1016	1300	NG/L	ND	ND	ND	ND
PCB 1221	1300	NG/L	ND	ND	ND	ND
PCB 1232	1300	NG/L	ND	ND	ND	ND
PCB 1242	1300	NG/L	ND	ND	ND	ND
PCB 1248	1300	NG/L	ND	ND	ND	ND
PCB 1254	1300	NG/L	ND	ND	ND	ND
PCB 1260	1300	NG/L	ND	ND	ND	ND
PCB 1262	1300	NG/L	ND	ND	ND	ND
p,p-DDD	20	NG/L	ND	ND	ND	ND
p,p-DDE	15	NG/L	DNQ52	DNQ91	ND	DNQ85
p,p-DDT	20	NG/L	ND	ND	ND	ND
Toxaphene	1300	NG/L	ND	ND	ND	ND
Trans Nonachlor	3	NG/L	ND	ND	NA	ND
=====	=====	=====	=====	=====	=====	=====
Aldrin + Dieldrin	10	NG/L	0	0	0	0
Hexachlorocyclohexanes	20	NG/L	0	0	0	0
DDT and derivatives	100	NG/L	0	0	0	0
Chlordane + related cmpds.	5	NG/L	0	0	0	0
Polychlorinated biphenyls	1300	NG/L	0	0	0	0
Endosulfans	15	NG/L	0	0	0	0
Heptachlors	15	NG/L	0	0	0	0
=====	=====	=====	=====	=====	=====	=====
Chlorinated Hydrocarbons	1300	NG/L	0	0	0	0

ND=not detected  
NA=not analyzed

Standards for alpha and gamma chlordene are no longer available in the U.S. for the analysis of these compounds.

SOUTH BAY WATER RECLAMATION PLANT  
Chlorinated Pesticide Analysis, EPA Method 608 (with additions)

Annual 2013

Source:			REC_WATER	REC_WATER	REC_WATER	REC_WATER
Date:			05-FEB-2013	07-MAY-2013	06-AUG-2013	01-OCT-2013
Analyte	MDL	Units	P649759	P661225	P671234	P677772
=====	=====	=====	=====	=====	=====	=====
Aldrin	8	NG/L	ND	ND	ND	ND
BHC, Alpha isomer	15	NG/L	ND	ND	ND	ND
BHC, Beta isomer	20	NG/L	ND	ND	ND	ND
BHC, Delta isomer	18	NG/L	ND	ND	ND	ND
BHC, Gamma isomer	15	NG/L	ND	ND	ND	ND
Alpha (cis) Chlordane	2	NG/L	ND	ND	ND	ND
Gamma (trans) Chlordane	2	NG/L	ND	ND	ND	ND
Alpha Chlordene		NG/L	NA	NA	NA	NA
Gamma Chlordene		NG/L	NA	NA	NA	NA
Cis Nonachlor	5	NG/L	ND	ND	NA	ND
Dieldrin	10	NG/L	ND	ND	ND	ND
Endosulfan Sulfate	15	NG/L	ND	ND	ND	ND
Alpha Endosulfan	15	NG/L	ND	ND	ND	ND
Beta Endosulfan	10	NG/L	ND	ND	ND	ND
Endrin	10	NG/L	ND	ND	ND	ND
Endrin aldehyde	10	NG/L	ND	ND	ND	ND
Heptachlor	15	NG/L	ND	ND	ND	ND
Heptachlor epoxide	13	NG/L	ND	ND	ND	ND
Methoxychlor	18	NG/L	ND	ND	ND	ND
Mirex	10	NG/L	ND	ND	ND	ND
o,p-DDD	100	NG/L	ND	ND	ND	ND
o,p-DDE	100	NG/L	ND	ND	ND	ND
o,p-DDT	100	NG/L	ND	ND	ND	ND
Oxychlordane	3	NG/L	ND	ND	NA	ND
PCB 1016	1300	NG/L	ND	ND	ND	ND
PCB 1221	1300	NG/L	ND	ND	ND	ND
PCB 1232	1300	NG/L	ND	ND	ND	ND
PCB 1242	1300	NG/L	ND	ND	ND	ND
PCB 1248	1300	NG/L	ND	ND	ND	ND
PCB 1254	1300	NG/L	ND	ND	ND	ND
PCB 1260	1300	NG/L	ND	ND	ND	ND
PCB 1262	1300	NG/L	ND	ND	ND	ND
p,p-DDD	20	NG/L	ND	ND	ND	ND
p,p-DDE	15	NG/L	ND	ND	ND	ND
p,p-DDT	20	NG/L	ND	ND	ND	ND
Toxaphene	1300	NG/L	ND	ND	ND	ND
Trans Nonachlor	3	NG/L	ND	ND	NA	ND
=====	=====	=====	=====	=====	=====	=====
Aldrin + Dieldrin	10	NG/L	0	0	0	0
Hexachlorocyclohexanes	20	NG/L	0	0	0	0
DDT and derivatives	100	NG/L	0	0	0	0
Chlordane + related cmpds.	5	NG/L	0	0	0	0
Polychlorinated biphenyls	1300	NG/L	0	0	0	0
Endosulfans	15	NG/L	0	0	0	0
Heptachlors	15	NG/L	0	0	0	0
=====	=====	=====	=====	=====	=====	=====
Chlorinated Hydrocarbons	1300	NG/L	0	0	0	0

ND=not detected  
NA=not analyzed

Standards for alpha and gamma chlordene are no longer available in the U.S. for the analysis of these compounds.

SOUTH BAY WATER RECLAMATION PLANT  
Organophosphorus Pesticides EPA Method 614/622 (with additions)

Annual 2013

Source:		INF	INF	EFF	EFF	EFF
Date:		07-MAY-2013	01-OCT-2013	07-MAY-2013	09-MAY-2013	01-OCT-2013
Analyte	MDL Units	P661191	P677738	P661196	P661379	P677743
Demeton O	.15 UG/L	ND	ND	ND	ND	ND
Demeton S	.08 UG/L	ND	ND	ND	ND	ND
Diazinon	.03 UG/L	ND	ND	ND	ND	ND
Guthion	.15 UG/L	ND	ND	ND	ND	ND
Malathion	.03 UG/L	DNQ0.05	ND	ND	ND	ND
Parathion	.03 UG/L	ND	ND	ND	ND	ND
Dichlorvos	.05 UG/L	ND	ND	ND	ND	ND
Disulfoton	.02 UG/L	ND	ND	ND	ND	ND
Dimethoate	.04 UG/L	ND	ND	ND	ND	ND
Stirophos	.03 UG/L	ND	ND	ND	ND	ND
Coumaphos	.15 UG/L	ND	ND	ND	ND	ND
Chlorpyrifos	.03 UG/L	ND	ND	ND	ND	ND
Thiophosphorus Pesticides	.15 UG/L	0.0	0.0	0.0	0.0	0.0
Demeton -O, -S	.15 UG/L	0.0	0.0	0.0	0.0	0.0
Total Organophosphorus Pesticides	.15 UG/L	0.0	0.0	0.0	0.0	0.0

Source:		COMB EFF	COMB EFF	PRI EFF	PRI EFF	SEC EFF
Date:		09-MAY-2013	01-OCT-2013	07-MAY-2013	01-OCT-2013	07-MAY-2013
Analyte	MDL Units	P661201	P677748	P661206	P677753	P661211
Demeton O	.15 UG/L	ND	ND	ND	ND	ND
Demeton S	.08 UG/L	ND	ND	ND	ND	ND
Diazinon	.03 UG/L	DNQ0.05	DNQ0.06	ND	ND	ND
Guthion	.15 UG/L	ND	ND	ND	ND	ND
Malathion	.03 UG/L	ND	ND	DNQ0.04	ND	ND
Parathion	.03 UG/L	ND	ND	ND	ND	ND
Dichlorvos	.05 UG/L	ND	ND	ND	ND	ND
Disulfoton	.02 UG/L	ND	ND	ND	ND	ND
Dimethoate	.04 UG/L	ND	ND	ND	ND	ND
Stirophos	.03 UG/L	ND	ND	ND	ND	ND
Coumaphos	.15 UG/L	ND	ND	ND	ND	ND
Chlorpyrifos	.03 UG/L	ND	ND	ND	ND	ND
Thiophosphorus Pesticides	.15 UG/L	0.0	0.0	0.0	0.0	0.0
Demeton -O, -S	.15 UG/L	0.0	0.0	0.0	0.0	0.0
Total Organophosphorus Pesticides	.15 UG/L	0.0	0.0	0.0	0.0	0.0

Source:		SEC EFF	RSL	RSL	RECLAIM	RECLAIM
Date:		01-OCT-2013	07-MAY-2013	01-OCT-2013	07-MAY-2013	01-OCT-2013
Analyte	MDL Units	P677758	P661223	P677770	P661225	P677772
Demeton O	.15 UG/L	ND	ND	ND	ND	ND
Demeton S	.08 UG/L	ND	ND	ND	ND	ND
Diazinon	.03 UG/L	ND	ND	ND	ND	ND
Guthion	.15 UG/L	ND	ND	ND	ND	ND
Malathion	.03 UG/L	ND	ND	ND	ND	ND
Parathion	.03 UG/L	ND	ND	ND	ND	ND
Dichlorvos	.05 UG/L	ND	ND	ND	ND	ND
Disulfoton	.02 UG/L	ND	ND	ND	ND	ND
Dimethoate	.04 UG/L	ND	ND	ND	ND	ND
Stirophos	.03 UG/L	ND	ND	ND	ND	ND
Coumaphos	.15 UG/L	ND	ND	ND	ND	ND
Chlorpyrifos	.03 UG/L	ND	ND	ND	ND	ND
Thiophosphorus Pesticides	.15 UG/L	0.0	0.0	0.0	0.0	0.0
Demeton -O, -S	.15 UG/L	0.0	0.0	0.0	0.0	0.0
Total Organophosphorus Pesticides	.15 UG/L	0.0	0.0	0.0	0.0	0.0

ND=not detected

DNQ=Detected not quantifiable, result value less than minimum level (ML) but greater or equal MDL.

SOUTH BAY WATER RECLAMATION PLANT  
Priority Pollutants Base/Neutral Compounds, EPA Method 625

Annual 2013

Source:			SB_INF_02	SB_INF_02	SB_INF_02	SB_INF_02
Date:			05-FEB-2013	07-MAY-2013	06-AUG-2013	01-OCT-2013
Analyte	MDL	Units	P649723	P661191	P671198	P677738
Acenaphthene	1.8	UG/L	ND	ND	ND	ND
Acenaphthylene	1.77	UG/L	ND	ND	ND	ND
Anthracene	1.29	UG/L	ND	ND	ND	ND
Benzidine	1.52	UG/L	ND	ND	ND	ND
Benzo[a]anthracene	1.1	UG/L	ND	ND	ND	ND
3,4-Benzo(b)fluoranthene	1.35	UG/L	ND	ND	ND	ND
Benzo[k]fluoranthene	1.49	UG/L	ND	ND	ND	ND
Benzo[a]pyrene	1.25	UG/L	ND	ND	ND	ND
Benzo[g,h,i]perylene	1.09	UG/L	ND	ND	ND	ND
4-Bromophenyl phenyl ether	1.4	UG/L	ND	ND	ND	ND
Bis-(2-chloroethoxy) methane	1.01	UG/L	ND	ND	ND	ND
Bis-(2-chloroethyl) ether	1.38	UG/L	ND	ND	ND	ND
Bis-(2-chloroisopropyl) ether	1.16	UG/L	ND	ND	ND	ND
4-Chlorophenyl phenyl ether	1.57	UG/L	ND	ND	ND	ND
2-Chloronaphthalene	1.87	UG/L	ND	ND	ND	ND
Chrysene	1.16	UG/L	ND	ND	ND	ND
Dibenzo(a,h)anthracene	1.01	UG/L	ND	ND	ND	ND
Butyl benzyl phthalate	2.84	UG/L	ND	ND	2.9	4.9
Di-n-butyl phthalate	3.96	UG/L	ND	ND	ND	ND
Bis-(2-ethylhexyl) phthalate	8.96	UG/L	10.2	16.3	ND	11.3
Diethyl phthalate	3.05	UG/L	5.2	5.2	5.2	7.0
Dimethyl phthalate	1.44	UG/L	ND	ND	ND	ND
Di-n-octyl phthalate	1	UG/L	ND	ND	ND	ND
3,3-Dichlorobenzidine	2.44	UG/L	ND	ND	ND	ND
2,4-Dinitrotoluene	1.36	UG/L	ND	ND	ND	ND
2,6-Dinitrotoluene	1.53	UG/L	ND	ND	ND	ND
1,2-Diphenylhydrazine	1.37	UG/L	ND	ND	ND	ND
Fluoranthene	1.33	UG/L	ND	ND	ND	ND
Fluorene	1.61	UG/L	ND	ND	ND	ND
Hexachlorobenzene	1.48	UG/L	ND	ND	ND	ND
Hexachlorobutadiene	1.64	UG/L	ND	ND	ND	ND
Hexachlorocyclopentadiene	1.25	UG/L	ND	ND	ND	ND
Hexachloroethane	1.32	UG/L	ND	ND	ND	ND
Indeno(1,2,3-CD)pyrene	1.14	UG/L	ND	ND	ND	ND
Isophorone	1.53	UG/L	ND	ND	ND	ND
Naphthalene	1.65	UG/L	ND	ND	ND	ND
Nitrobenzene	1.6	UG/L	ND	ND	ND	ND
N-nitrosodimethylamine	1.27	UG/L	ND	ND	ND	ND
N-nitrosodi-n-propylamine	1.16	UG/L	ND	ND	ND	ND
N-nitrosodiphenylamine	3.48	UG/L	ND	ND	ND	ND
Phenanthrene	1.34	UG/L	ND	ND	ND	ND
Pyrene	1.43	UG/L	ND	ND	ND	ND
1,2,4-Trichlorobenzene	1.52	UG/L	ND	ND	ND	ND
Polynuc. Aromatic Hydrocarbons	1.77	UG/L	0.0	0.0	0.0	0.0
Base/Neutral Compounds	8.96	UG/L	15.4	21.5	8.1	23.2

Additional analytes determined

Benzo[e]pyrene	1.44	UG/L	ND	ND	ND	ND
Biphenyl	2.29	UG/L	ND	ND	ND	ND
2,6-Dimethylnaphthalene	2.16	UG/L	ND	ND	ND	ND
1-Methylnaphthalene	2.18	UG/L	ND	ND	ND	ND
1-Methylphenanthrene	1.46	UG/L	ND	ND	ND	ND
2-Methylnaphthalene	2.14	UG/L	ND	ND	ND	ND
2,3,5-Trimethylnaphthalene	2.18	UG/L	ND	ND	ND	ND
Perylene	1.41	UG/L	ND	ND	ND	ND
Pyridine	3.33	UG/L	ND	ND	ND	ND

ND= not detected

SOUTH BAY WATER RECLAMATION PLANT  
Priority Pollutants Base/Neutral Compounds, EPA Method 625

Annual 2013

Source:			SB_OUTFALL_01	SB_OUTFALL_01	SB_OUTFALL_01	SB_OUTFALL_01
Date:			05-FEB-2013	07-MAY-2013	06-AUG-2013	01-OCT-2013
Analyte	MDL	Units	P649728	P661196	P671203	P677743
Acenaphthene	1.8	UG/L	ND	ND	ND	ND
Acenaphthylene	1.77	UG/L	ND	ND	ND	ND
Anthracene	1.29	UG/L	ND	ND	ND	ND
Benzidine	1.52	UG/L	ND	ND	ND	ND
Benzo[a]anthracene	1.1	UG/L	ND	ND	ND	ND
3,4-Benzo(b)fluoranthene	1.35	UG/L	ND	ND	ND	ND
Benzo[k]fluoranthene	1.49	UG/L	ND	ND	ND	ND
Benzo[a]pyrene	1.25	UG/L	ND	ND	ND	ND
Benzo[g,h,i]perylene	1.09	UG/L	ND	ND	ND	ND
4-Bromophenyl phenyl ether	1.4	UG/L	ND	ND	ND	ND
Bis-(2-chloroethoxy) methane	1.01	UG/L	ND	ND	ND	ND
Bis-(2-chloroethyl) ether	1.38	UG/L	ND	ND	ND	ND
Bis-(2-chloroisopropyl) ether	1.16	UG/L	ND	ND	ND	ND
4-Chlorophenyl phenyl ether	1.57	UG/L	ND	ND	ND	ND
2-Chloronaphthalene	1.87	UG/L	ND	ND	ND	ND
Chrysene	1.16	UG/L	ND	ND	ND	ND
Dibenzo(a,h)anthracene	1.01	UG/L	ND	ND	ND	ND
Butyl benzyl phthalate	2.84	UG/L	ND	ND	ND	ND
Di-n-butyl phthalate	3.96	UG/L	ND	ND	ND	ND
Bis-(2-ethylhexyl) phthalate	8.96	UG/L	ND	ND	ND	ND
Diethyl phthalate	3.05	UG/L	ND	ND	ND	ND
Dimethyl phthalate	1.44	UG/L	ND	ND	ND	ND
Di-n-octyl phthalate	1	UG/L	ND	ND	ND	ND
3,3-Dichlorobenzidine	2.44	UG/L	ND	ND	ND	ND
2,4-Dinitrotoluene	1.36	UG/L	ND	ND	ND	ND
2,6-Dinitrotoluene	1.53	UG/L	ND	ND	ND	ND
1,2-Diphenylhydrazine	1.37	UG/L	ND	ND	ND	ND
Fluoranthene	1.33	UG/L	ND	ND	ND	ND
Fluorene	1.61	UG/L	ND	ND	ND	ND
Hexachlorobenzene	1.48	UG/L	ND	ND	ND	ND
Hexachlorobutadiene	1.64	UG/L	ND	ND	ND	ND
Hexachlorocyclopentadiene	1.25	UG/L	ND	ND	ND	ND
Hexachloroethane	1.32	UG/L	ND	ND	ND	ND
Indeno(1,2,3-CD)pyrene	1.14	UG/L	ND	ND	ND	ND
Isophorone	1.53	UG/L	ND	ND	ND	ND
Naphthalene	1.65	UG/L	ND	ND	ND	ND
Nitrobenzene	1.6	UG/L	ND	ND	ND	ND
N-nitrosodimethylamine	1.27	UG/L	ND	ND	ND	ND
N-nitrosodi-n-propylamine	1.16	UG/L	ND	ND	ND	ND
N-nitrosodiphenylamine	3.48	UG/L	ND	ND	ND	ND
Phenanthrene	1.34	UG/L	ND	ND	ND	ND
Pyrene	1.43	UG/L	ND	ND	ND	ND
1,2,4-Trichlorobenzene	1.52	UG/L	ND	ND	ND	ND
Polynuc. Aromatic Hydrocarbons	1.77	UG/L	0.0	0.0	0.0	0.0
Base/Neutral Compounds	8.96	UG/L	0.0	0.0	0.0	0.0

Additional analytes determined

Benzo[e]pyrene	1.44	UG/L	ND	ND	ND	ND
Biphenyl	2.29	UG/L	ND	ND	ND	ND
2,6-Dimethylnaphthalene	2.16	UG/L	ND	ND	ND	ND
1-Methylnaphthalene	2.18	UG/L	ND	ND	ND	ND
1-Methylphenanthrene	1.46	UG/L	ND	ND	ND	ND
2-Methylnaphthalene	2.14	UG/L	ND	ND	ND	ND
2,3,5-Trimethylnaphthalene	2.18	UG/L	ND	ND	ND	ND
Perylene	1.41	UG/L	ND	ND	ND	ND
Pyridine	3.33	UG/L	ND	ND	ND	ND

ND= not detected

SOUTH BAY WATER RECLAMATION PLANT  
Priority Pollutants Base/Neutral Compounds, EPA Method 625

Annual 2013

Source:			SB_ITP_COMB_EFF	SB_ITP_COMB_EFF	SB_ITP_COMB_EFF	SB_ITP_COMB_EFF
Date:			05-FEB-2013	09-MAY-2013	06-AUG-2013	01-OCT-2013
Analyte	MDL	Units	P649733	P661201	P671208	P677748
Acenaphthene	1.8	UG/L	ND	ND	ND	ND
Acenaphthylene	1.77	UG/L	ND	ND	ND	ND
Anthracene	1.29	UG/L	ND	ND	ND	ND
Benzidine	1.52	UG/L	ND	ND	ND	ND
Benzo[a]anthracene	1.1	UG/L	ND	ND	ND	ND
3,4-Benzo(b)fluoranthene	1.35	UG/L	ND	ND	ND	ND
Benzo[k]fluoranthene	1.49	UG/L	ND	ND	ND	ND
Benzo[a]pyrene	1.25	UG/L	ND	ND	ND	ND
Benzo[g,h,i]perylene	1.09	UG/L	ND	ND	ND	ND
4-Bromophenyl phenyl ether	1.4	UG/L	ND	ND	ND	ND
Bis-(2-chloroethoxy) methane	1.01	UG/L	ND	ND	ND	ND
Bis-(2-chloroethyl) ether	1.38	UG/L	ND	ND	ND	ND
Bis-(2-chloroisopropyl) ether	1.16	UG/L	ND	ND	ND	ND
4-Chlorophenyl phenyl ether	1.57	UG/L	ND	ND	ND	ND
2-Chloronaphthalene	1.87	UG/L	ND	ND	ND	ND
Chrysene	1.16	UG/L	ND	ND	ND	ND
Dibenzo(a,h)anthracene	1.01	UG/L	ND	ND	ND	ND
Butyl benzyl phthalate	2.84	UG/L	ND	ND	ND	ND
Di-n-butyl phthalate	3.96	UG/L	ND	ND	ND	ND
Bis-(2-ethylhexyl) phthalate	8.96	UG/L	ND	ND	ND	ND
Diethyl phthalate	3.05	UG/L	ND	ND	ND	ND
Dimethyl phthalate	1.44	UG/L	ND	ND	ND	ND
Di-n-octyl phthalate	1	UG/L	ND	ND	ND	ND
3,3-Dichlorobenzidine	2.44	UG/L	ND	ND	ND	ND
2,4-Dinitrotoluene	1.36	UG/L	ND	ND	ND	ND
2,6-Dinitrotoluene	1.53	UG/L	ND	ND	ND	ND
1,2-Diphenylhydrazine	1.37	UG/L	ND	ND	ND	ND
Fluoranthene	1.33	UG/L	ND	ND	ND	ND
Fluorene	1.61	UG/L	ND	ND	ND	ND
Hexachlorobenzene	1.48	UG/L	ND	ND	ND	ND
Hexachlorobutadiene	1.64	UG/L	ND	ND	ND	ND
Hexachlorocyclopentadiene	1.25	UG/L	ND	ND	ND	ND
Hexachloroethane	1.32	UG/L	ND	ND	ND	ND
Indeno(1,2,3-CD)pyrene	1.14	UG/L	ND	ND	ND	ND
Isophorone	1.53	UG/L	ND	ND	ND	ND
Naphthalene	1.65	UG/L	ND	ND	ND	ND
Nitrobenzene	1.6	UG/L	ND	ND	ND	ND
N-nitrosodimethylamine	1.27	UG/L	ND	ND	ND	ND
N-nitrosodi-n-propylamine	1.16	UG/L	ND	ND	ND	ND
N-nitrosodiphenylamine	3.48	UG/L	ND	ND	ND	ND
Phenanthrene	1.34	UG/L	ND	ND	ND	ND
Pyrene	1.43	UG/L	ND	ND	ND	ND
1,2,4-Trichlorobenzene	1.52	UG/L	ND	ND	ND	ND
Polynuc. Aromatic Hydrocarbons	1.77	UG/L	0.0	0.0	0.0	0.0
Base/Neutral Compounds	8.96	UG/L	0.0	0.0	0.0	0.0

Additional analytes determined

Benzo[e]pyrene	1.44	UG/L	ND	ND	ND	ND
Biphenyl	2.29	UG/L	ND	ND	ND	ND
2,6-Dimethylnaphthalene	2.16	UG/L	ND	ND	ND	ND
1-Methylnaphthalene	2.18	UG/L	ND	ND	ND	ND
1-Methylphenanthrene	1.46	UG/L	ND	ND	ND	ND
2-Methylnaphthalene	2.14	UG/L	ND	ND	ND	ND
2,3,5-Trimethylnaphthalene	2.18	UG/L	ND	ND	ND	ND
Perylene	1.41	UG/L	ND	ND	ND	ND
Pyridine	3.33	UG/L	ND	ND	ND	ND

ND= not detected



SOUTH BAY WATER RECLAMATION PLANT  
Priority Pollutants Base/Neutral Compounds, EPA Method 625

Annual 2013

Source:			SB_PRIEFF_10	SB_PRIEFF_10	SB_PRIEFF_10	SB_PRIEFF_10
Date:			05-FEB-2013	07-MAY-2013	06-AUG-2013	01-OCT-2013
Analyte	MDL	Units	P649738	P661206	P671213	P677753
Acenaphthene	1.8	UG/L	ND	ND	ND	ND
Acenaphthylene	1.77	UG/L	ND	ND	ND	ND
Anthracene	1.29	UG/L	ND	ND	ND	ND
Benzidine	1.52	UG/L	ND	ND	ND	ND
Benzo[a]anthracene	1.1	UG/L	ND	ND	ND	ND
3,4-Benzo(b)fluoranthene	1.35	UG/L	ND	ND	ND	ND
Benzo[k]fluoranthene	1.49	UG/L	ND	ND	ND	ND
Benzo[a]pyrene	1.25	UG/L	ND	ND	ND	ND
Benzo[g,h,i]perylene	1.09	UG/L	ND	ND	ND	ND
4-Bromophenyl phenyl ether	1.4	UG/L	ND	ND	ND	ND
Bis-(2-chloroethoxy) methane	1.01	UG/L	ND	ND	ND	ND
Bis-(2-chloroethyl) ether	1.38	UG/L	ND	ND	ND	ND
Bis-(2-chloroisopropyl) ether	1.16	UG/L	ND	ND	ND	ND
4-Chlorophenyl phenyl ether	1.57	UG/L	ND	ND	ND	ND
2-Chloronaphthalene	1.87	UG/L	ND	ND	ND	ND
Chrysene	1.16	UG/L	ND	ND	ND	ND
Dibenzo(a,h)anthracene	1.01	UG/L	ND	ND	ND	ND
Butyl benzyl phthalate	2.84	UG/L	ND	ND	ND	ND
Di-n-butyl phthalate	3.96	UG/L	ND	ND	ND	ND
Bis-(2-ethylhexyl) phthalate	8.96	UG/L	12.7	ND	ND	9.0
Diethyl phthalate	3.05	UG/L	6.1	ND	3.5	4.0
Dimethyl phthalate	1.44	UG/L	ND	ND	ND	ND
Di-n-octyl phthalate	1	UG/L	ND	ND	ND	ND
3,3-Dichlorobenzidine	2.44	UG/L	ND	ND	ND	ND
2,4-Dinitrotoluene	1.36	UG/L	ND	ND	ND	ND
2,6-Dinitrotoluene	1.53	UG/L	ND	ND	ND	ND
1,2-Diphenylhydrazine	1.37	UG/L	ND	ND	ND	ND
Fluoranthene	1.33	UG/L	ND	ND	ND	ND
Fluorene	1.61	UG/L	ND	ND	ND	ND
Hexachlorobenzene	1.48	UG/L	ND	ND	ND	ND
Hexachlorobutadiene	1.64	UG/L	ND	ND	ND	ND
Hexachlorocyclopentadiene	1.25	UG/L	ND	ND	ND	ND
Hexachloroethane	1.32	UG/L	ND	ND	ND	ND
Indeno(1,2,3-CD)pyrene	1.14	UG/L	ND	ND	ND	ND
Isophorone	1.53	UG/L	ND	ND	ND	ND
Naphthalene	1.65	UG/L	ND	ND	ND	ND
Nitrobenzene	1.6	UG/L	ND	ND	ND	ND
N-nitrosodimethylamine	1.27	UG/L	ND	ND	ND	ND
N-nitrosodi-n-propylamine	1.16	UG/L	ND	ND	ND	ND
N-nitrosodiphenylamine	3.48	UG/L	ND	ND	ND	ND
Phenanthrene	1.34	UG/L	ND	ND	ND	ND
Pyrene	1.43	UG/L	ND	ND	ND	ND
1,2,4-Trichlorobenzene	1.52	UG/L	ND	ND	ND	ND
Polynuc. Aromatic Hydrocarbons	1.77	UG/L	0.0	0.0	0.0	0.0
Base/Neutral Compounds	8.96	UG/L	18.8	0.0	3.5	13.0

Additional analytes determined

Benzo[e]pyrene	1.44	UG/L	ND	ND	ND	ND
Biphenyl	2.29	UG/L	ND	ND	ND	ND
2,6-Dimethylnaphthalene	2.16	UG/L	ND	ND	ND	ND
1-Methylnaphthalene	2.18	UG/L	ND	ND	ND	ND
1-Methylphenanthrene	1.46	UG/L	ND	ND	ND	ND
2-Methylnaphthalene	2.14	UG/L	ND	ND	ND	ND
2,3,5-Trimethylnaphthalene	2.18	UG/L	ND	ND	ND	ND
Perylene	1.41	UG/L	ND	ND	ND	ND
Pyridine	3.33	UG/L	ND	ND	ND	ND

ND= not detected

SOUTH BAY WATER RECLAMATION PLANT  
Priority Pollutants Base/Neutral Compounds, EPA Method 625

Annual 2013

Source:		SB_SEC_EFF_20	SB_SEC_EFF_20	SB_SEC_EFF_20	SB_SEC_EFF_20
Date:		05-FEB-2013	07-MAY-2013	06-AUG-2013	01-OCT-2013
Analyte	MDL Units	P649743	P661211	P671218	P677758
Acenaphthene	1.8 UG/L	ND	ND	ND	ND
Acenaphthylene	1.77 UG/L	ND	ND	ND	ND
Anthracene	1.29 UG/L	ND	ND	ND	ND
Benzidine	1.52 UG/L	ND	ND	ND	ND
Benzo[a]anthracene	1.1 UG/L	ND	ND	ND	ND
3,4-Benzo(b)fluoranthene	1.35 UG/L	ND	ND	ND	ND
Benzo[k]fluoranthene	1.49 UG/L	ND	ND	ND	ND
Benzo[a]pyrene	1.25 UG/L	ND	ND	ND	ND
Benzo[g,h,i]perylene	1.09 UG/L	ND	ND	ND	ND
4-Bromophenyl phenyl ether	1.4 UG/L	ND	ND	ND	ND
Bis-(2-chloroethoxy) methane	1.01 UG/L	ND	ND	ND	ND
Bis-(2-chloroethyl) ether	1.38 UG/L	ND	ND	ND	ND
Bis-(2-chloroisopropyl) ether	1.16 UG/L	ND	ND	ND	ND
4-Chlorophenyl phenyl ether	1.57 UG/L	ND	ND	ND	ND
2-Chloronaphthalene	1.87 UG/L	ND	ND	ND	ND
Chrysene	1.16 UG/L	ND	ND	ND	ND
Dibenzo(a,h)anthracene	1.01 UG/L	ND	ND	ND	ND
Butyl benzyl phthalate	2.84 UG/L	ND	ND	ND	ND
Di-n-butyl phthalate	3.96 UG/L	ND	ND	ND	ND
Bis-(2-ethylhexyl) phthalate	8.96 UG/L	ND	ND	ND	ND
Diethyl phthalate	3.05 UG/L	ND	ND	ND	ND
Dimethyl phthalate	1.44 UG/L	ND	ND	ND	ND
Di-n-octyl phthalate	1 UG/L	ND	ND	ND	ND
3,3-Dichlorobenzidine	2.44 UG/L	ND	ND	ND	ND
2,4-Dinitrotoluene	1.36 UG/L	ND	ND	ND	ND
2,6-Dinitrotoluene	1.53 UG/L	ND	ND	ND	ND
1,2-Diphenylhydrazine	1.37 UG/L	ND	ND	ND	ND
Fluoranthene	1.33 UG/L	ND	ND	ND	ND
Fluorene	1.61 UG/L	ND	ND	ND	ND
Hexachlorobenzene	1.48 UG/L	ND	ND	ND	ND
Hexachlorobutadiene	1.64 UG/L	ND	ND	ND	ND
Hexachlorocyclopentadiene	1.25 UG/L	ND	ND	ND	ND
Hexachloroethane	1.32 UG/L	ND	ND	ND	ND
Indeno(1,2,3-CD)pyrene	1.14 UG/L	ND	ND	ND	ND
Isophorone	1.53 UG/L	ND	ND	ND	ND
Naphthalene	1.65 UG/L	ND	ND	ND	ND
Nitrobenzene	1.6 UG/L	ND	ND	ND	ND
N-nitrosodimethylamine	1.27 UG/L	ND	ND	ND	ND
N-nitrosodi-n-propylamine	1.16 UG/L	ND	ND	ND	ND
N-nitrosodiphenylamine	3.48 UG/L	ND	ND	ND	ND
Phenanthrene	1.34 UG/L	ND	ND	ND	ND
Pyrene	1.43 UG/L	ND	ND	ND	ND
1,2,4-Trichlorobenzene	1.52 UG/L	ND	ND	ND	ND
Polynuc. Aromatic Hydrocarbons	1.77 UG/L	0.0	0.0	0.0	0.0
Base/Neutral Compounds	8.96 UG/L	0.0	0.0	0.0	0.0

Additional analytes determined

Benzo[e]pyrene	1.44 UG/L	ND	ND	ND	ND
Biphenyl	2.29 UG/L	ND	ND	ND	ND
2,6-Dimethylnaphthalene	2.16 UG/L	ND	ND	ND	ND
1-Methylnaphthalene	2.18 UG/L	ND	ND	ND	ND
1-Methylphenanthrene	1.46 UG/L	ND	ND	ND	ND
2-Methylnaphthalene	2.14 UG/L	ND	ND	ND	ND
2,3,5-Trimethylnaphthalene	2.18 UG/L	ND	ND	ND	ND
Perylene	1.41 UG/L	ND	ND	ND	ND
Pyridine	3.33 UG/L	ND	ND	ND	ND

ND= not detected

SOUTH BAY WATER RECLAMATION PLANT  
Priority Pollutants Base/Neutral Compounds, EPA Method 625

Annual 2013

Source:		SB_REC_WATER_34	SB_REC_WATER_34	SB_REC_WATER_34	SB_REC_WATER_34
Date:		05-FEB-2013	07-MAY-2013	06-AUG-2013	01-OCT-2013
Analyte	MDL Units	P649759	P661225	P671234	P677772
Acenaphthene	1.8 UG/L	ND	ND	ND	ND
Acenaphthylene	1.77 UG/L	ND	ND	ND	ND
Anthracene	1.29 UG/L	ND	ND	ND	ND
Benzidine	1.52 UG/L	ND	ND	ND	ND
Benzo[a]anthracene	1.1 UG/L	ND	ND	ND	ND
3,4-Benzo(b)fluoranthene	1.35 UG/L	ND	ND	ND	ND
Benzo[k]fluoranthene	1.49 UG/L	ND	ND	ND	ND
Benzo[a]pyrene	1.25 UG/L	ND	ND	ND	ND
Benzo[g,h,i]perylene	1.09 UG/L	ND	ND	ND	ND
4-Bromophenyl phenyl ether	1.4 UG/L	ND	ND	ND	ND
Bis-(2-chloroethoxy) methane	1.01 UG/L	ND	ND	ND	ND
Bis-(2-chloroethyl) ether	1.38 UG/L	ND	ND	ND	ND
Bis-(2-chloroisopropyl) ether	1.16 UG/L	ND	ND	ND	ND
4-Chlorophenyl phenyl ether	1.57 UG/L	ND	ND	ND	ND
2-Chloronaphthalene	1.87 UG/L	ND	ND	ND	ND
Chrysene	1.16 UG/L	ND	ND	ND	ND
Dibenzo(a,h)anthracene	1.01 UG/L	ND	ND	ND	ND
Butyl benzyl phthalate	2.84 UG/L	ND	ND	ND	ND
Di-n-butyl phthalate	3.96 UG/L	ND	ND	ND	ND
Bis-(2-ethylhexyl) phthalate	8.96 UG/L	ND	ND	21.4	ND
Diethyl phthalate	3.05 UG/L	ND	ND	ND	ND
Dimethyl phthalate	1.44 UG/L	ND	ND	ND	ND
Di-n-octyl phthalate	1 UG/L	ND	ND	ND	ND
3,3-Dichlorobenzidine	2.44 UG/L	ND	ND	ND	ND
2,4-Dinitrotoluene	1.36 UG/L	ND	ND	ND	ND
2,6-Dinitrotoluene	1.53 UG/L	ND	ND	ND	ND
1,2-Diphenylhydrazine	1.37 UG/L	ND	ND	ND	ND
Fluoranthene	1.33 UG/L	ND	ND	ND	ND
Fluorene	1.61 UG/L	ND	ND	ND	ND
Hexachlorobenzene	1.48 UG/L	ND	ND	ND	ND
Hexachlorobutadiene	1.64 UG/L	ND	ND	ND	ND
Hexachlorocyclopentadiene	1.25 UG/L	ND	ND	ND	ND
Hexachloroethane	1.32 UG/L	ND	ND	ND	ND
Indeno(1,2,3-CD)pyrene	1.14 UG/L	ND	ND	ND	ND
Isophorone	1.53 UG/L	ND	ND	ND	ND
Naphthalene	1.65 UG/L	ND	ND	ND	ND
Nitrobenzene	1.6 UG/L	ND	ND	ND	ND
N-nitrosodimethylamine	1.27 UG/L	ND	ND	ND	ND
N-nitrosodi-n-propylamine	1.16 UG/L	ND	ND	ND	ND
N-nitrosodiphenylamine	3.48 UG/L	ND	ND	ND	ND
Phenanthrene	1.34 UG/L	ND	ND	ND	ND
Pyrene	1.43 UG/L	ND	ND	ND	ND
1,2,4-Trichlorobenzene	1.52 UG/L	ND	ND	ND	ND
Polynuc. Aromatic Hydrocarbons	1.77 UG/L	0.0	0.0	0.0	0.0
Base/Neutral Compounds	8.96 UG/L	0.0	0.0	21.4	0.0

Additional analytes determined

Benzo[e]pyrene	1.44 UG/L	ND	ND	ND	ND
Biphenyl	2.29 UG/L	ND	ND	ND	ND
2,6-Dimethylnaphthalene	2.16 UG/L	ND	ND	ND	ND
1-Methylnaphthalene	2.18 UG/L	ND	ND	ND	ND
1-Methylphenanthrene	1.46 UG/L	ND	ND	ND	ND
2-Methylnaphthalene	2.14 UG/L	ND	ND	ND	ND
2,3,5-Trimethylnaphthalene	2.18 UG/L	ND	ND	ND	ND
Perylene	1.41 UG/L	ND	ND	ND	ND
Pyridine	3.33 UG/L	ND	ND	ND	ND

ND= not detected

SOUTH BAY WATER RECLAMATION PLANT  
ACID EXTRACTABLE COMPOUNDS, EPA Method 625

Annual 2013

Source:			INFLUENT	INFLUENT	INFLUENT	INFLUENT
Date:			05-FEB-2013	07-MAY-2013	06-AUG-2013	01-OCT-2013
Analyte	MDL	Units	P649723	P661191	P671198	P677738
2-Chlorophenol	1.32	UG/L	ND	ND	ND	ND
2,4-Dichlorophenol	1.01	UG/L	ND	ND	ND	ND
4-Chloro-3-methylphenol	1.67	UG/L	ND	ND	ND	ND
2,4,6-Trichlorophenol	1.65	UG/L	ND	ND	ND	ND
Pentachlorophenol	1.12	UG/L	ND	ND	ND	ND
Phenol	1.76	UG/L	28.3	46.9	51.2	59.5
2-Nitrophenol	1.55	UG/L	ND	ND	ND	ND
2,4-Dimethylphenol	2.01	UG/L	ND	ND	ND	ND
2,4-Dinitrophenol	2.16	UG/L	ND	ND	ND	ND
4-Nitrophenol	1.14	UG/L	ND	ND	ND	ND
2-Methyl-4,6-dinitrophenol	1.52	UG/L	ND	ND	ND	ND
=====						
Total Chlorinated Phenols	1.67	UG/L	0.0	0.0	0.0	0.0
Total Non-Chlorinated Phenols	2.16	UG/L	28.3	46.9	51.2	59.5
=====						
Total Phenols	2.16	UG/L	28.3	46.9	51.2	59.5

Additional analytes determined

2-Methylphenol	2.15	UG/L	ND	ND	ND	ND
3-Methylphenol(4-MP is unresolved)		UG/L	NA	NA	NA	NA
4-Methylphenol(3-MP is unresolved)	2.11	UG/L	87.6	116	113	126
2,4,5-Trichlorophenol	1.66	UG/L	ND	ND	ND	ND

Source:			EFFLUENT	EFFLUENT	EFFLUENT	EFFLUENT
Date:			05-FEB-2013	07-MAY-2013	06-AUG-2013	01-OCT-2013
Analyte	MDL	Units	P649728	P661196	P671203	P677743
2-Chlorophenol	1.32	UG/L	ND	ND	ND	ND
2,4-Dichlorophenol	1.01	UG/L	ND	ND	ND	ND
4-Chloro-3-methylphenol	1.67	UG/L	ND	ND	ND	ND
2,4,6-Trichlorophenol	1.65	UG/L	ND	ND	ND	ND
Pentachlorophenol	1.12	UG/L	ND	ND	ND	ND
Phenol	1.76	UG/L	ND	ND	ND	ND
2-Nitrophenol	1.55	UG/L	ND	ND	ND	ND
2,4-Dimethylphenol	2.01	UG/L	ND	ND	ND	ND
2,4-Dinitrophenol	2.16	UG/L	ND	ND	ND	ND
4-Nitrophenol	1.14	UG/L	ND	ND	ND	ND
2-Methyl-4,6-dinitrophenol	1.52	UG/L	ND	ND	ND	ND
=====						
Total Chlorinated Phenols	1.67	UG/L	0.0	0.0	0.0	0.0
Total Non-Chlorinated Phenols	2.16	UG/L	0.0	0.0	0.0	0.0
=====						
Total Phenols	2.16	UG/L	0.0	0.0	0.0	0.0

Additional analytes determined

2-Methylphenol	2.15	UG/L	ND	ND	ND	ND
3-Methylphenol(4-MP is unresolved)		UG/L	NA	NA	NA	NA
4-Methylphenol(3-MP is unresolved)	2.11	UG/L	ND	ND	ND	ND
2,4,5-Trichlorophenol	1.66	UG/L	ND	ND	ND	ND

ND= not detected  
NA= not analyzed

SOUTH BAY WATER RECLAMATION PLANT  
ACID EXTRACTABLE COMPOUNDS, EPA Method 625

Annual 2013

Source:			COMB EFF	COMB EFF	COMB EFF	COMB EFF
Date:			05-FEB-2013	09-MAY-2013	06-AUG-2013	01-OCT-2013
Analyte	MDL	Units	P649733	P661201	P671208	P677748
2-Chlorophenol	1.32	UG/L	ND	ND	ND	ND
2,4-Dichlorophenol	1.01	UG/L	ND	ND	ND	ND
4-Chloro-3-methylphenol	1.67	UG/L	ND	ND	ND	ND
2,4,6-Trichlorophenol	1.65	UG/L	ND	ND	ND	ND
Pentachlorophenol	1.12	UG/L	ND	ND	ND	ND
Phenol	1.76	UG/L	ND	ND	ND	ND
2-Nitrophenol	1.55	UG/L	ND	ND	ND	ND
2,4-Dimethylphenol	2.01	UG/L	ND	ND	ND	ND
2,4-Dinitrophenol	2.16	UG/L	ND	ND	ND	ND
4-Nitrophenol	1.14	UG/L	ND	ND	ND	ND
2-Methyl-4,6-dinitrophenol	1.52	UG/L	ND	ND	ND	ND
=====						
Total Chlorinated Phenols	1.67	UG/L	0.0	0.0	0.0	0.0
Total Non-Chlorinated Phenols	2.16	UG/L	0.0	0.0	0.0	0.0
=====						
Total Phenols	2.16	UG/L	0.0	0.0	0.0	0.0

Additional analytes determined

2-Methylphenol	2.15	UG/L	ND	ND	ND	ND
3-Methylphenol(4-MP is unresolved)		UG/L	NA	NA	NA	NA
4-Methylphenol(3-MP is unresolved)	2.11	UG/L	ND	ND	ND	ND
2,4,5-Trichlorophenol	1.66	UG/L	ND	ND	ND	ND

Source:			PRI EFF	PRI EFF	PRI EFF	PRI EFF
Date:			05-FEB-2013	07-MAY-2013	06-AUG-2013	01-OCT-2013
Analyte	MDL	Units	P649738	P661206	P671213	P677753
2-Chlorophenol	1.32	UG/L	ND	ND	ND	ND
2,4-Dichlorophenol	1.01	UG/L	ND	ND	ND	ND
4-Chloro-3-methylphenol	1.67	UG/L	ND	ND	ND	ND
2,4,6-Trichlorophenol	1.65	UG/L	ND	ND	ND	ND
Pentachlorophenol	1.12	UG/L	ND	ND	ND	ND
Phenol	1.76	UG/L	41.5	11.7	19.9	17.2
2-Nitrophenol	1.55	UG/L	ND	ND	ND	ND
2,4-Dimethylphenol	2.01	UG/L	ND	ND	ND	ND
2,4-Dinitrophenol	2.16	UG/L	ND	ND	ND	ND
4-Nitrophenol	1.14	UG/L	ND	ND	ND	ND
2-Methyl-4,6-dinitrophenol	1.52	UG/L	ND	ND	ND	ND
=====						
Total Chlorinated Phenols	1.67	UG/L	0.0	0.0	0.0	0.0
Total Non-Chlorinated Phenols	2.16	UG/L	41.5	11.7	19.9	17.2
=====						
Total Phenols	2.16	UG/L	41.5	11.7	19.9	17.2

Additional analytes determined

2-Methylphenol	2.15	UG/L	ND	ND	ND	ND
3-Methylphenol(4-MP is unresolved)		UG/L	NA	NA	NA	NA
4-Methylphenol(3-MP is unresolved)	2.11	UG/L	116	19.0	50.7	31.8
2,4,5-Trichlorophenol	1.66	UG/L	ND	ND	ND	ND

ND= not detected  
NA= not analyzed

SOUTH BAY WATER RECLAMATION PLANT  
ACID EXTRACTABLE COMPOUNDS, EPA Method 625

Annual 2013

Source:			SEC EFF	SEC EFF	SEC EFF	SEC EFF
Date:			05-FEB-2013	07-MAY-2013	06-AUG-2013	01-OCT-2013
Analyte	MDL Units		P649743	P661211	P671218	P677758
2-Chlorophenol	1.32 UG/L		ND	ND	ND	ND
2,4-Dichlorophenol	1.01 UG/L		ND	ND	ND	ND
4-Chloro-3-methylphenol	1.67 UG/L		ND	ND	ND	ND
2,4,6-Trichlorophenol	1.65 UG/L		ND	ND	ND	ND
Pentachlorophenol	1.12 UG/L		ND	ND	ND	ND
Phenol	1.76 UG/L		ND	ND	ND	ND
2-Nitrophenol	1.55 UG/L		ND	ND	ND	ND
2,4-Dimethylphenol	2.01 UG/L		ND	ND	ND	ND
2,4-Dinitrophenol	2.16 UG/L		ND	ND	ND	ND
4-Nitrophenol	1.14 UG/L		ND	ND	ND	ND
2-Methyl-4,6-dinitrophenol	1.52 UG/L		ND	ND	ND	ND
Total Chlorinated Phenols	1.67 UG/L		0.0	0.0	0.0	0.0
Total Non-Chlorinated Phenols	2.16 UG/L		0.0	0.0	0.0	0.0
Total Phenols	2.16 UG/L		0.0	0.0	0.0	0.0

Additional analytes determined

2-Methylphenol	2.15 UG/L		ND	ND	ND	ND
3-Methylphenol(4-MP is unresolved)	UG/L		NA	NA	NA	NA
4-Methylphenol(3-MP is unresolved)	2.11 UG/L		ND	ND	ND	ND
2,4,5-Trichlorophenol	1.66 UG/L		ND	ND	ND	ND

Source:			RSL	RSL	RSL	RSL
Date:			05-FEB-2013	07-MAY-2013	06-AUG-2013	01-OCT-2013
Analyte	MDL Units		P649757	P661223	P671232	P677770
2-Chlorophenol	1.32 UG/L		ND	ND	ND	ND
2,4-Dichlorophenol	1.01 UG/L		ND	ND	ND	ND
4-Chloro-3-methylphenol	1.67 UG/L		ND	ND	ND	ND
2,4,6-Trichlorophenol	1.65 UG/L		ND	ND	ND	ND
Pentachlorophenol	1.12 UG/L		ND	ND	ND	ND
Phenol	1.76 UG/L		82.7	94.3	82.6	94.6
2-Nitrophenol	1.55 UG/L		ND	ND	ND	ND
2,4-Dimethylphenol	2.01 UG/L		ND	ND	ND	ND
2,4-Dinitrophenol	2.16 UG/L		ND	ND	ND	ND
4-Nitrophenol	1.14 UG/L		ND	ND	ND	ND
2-Methyl-4,6-dinitrophenol	1.52 UG/L		ND	ND	ND	ND
Total Chlorinated Phenols	1.67 UG/L		0.0	0.0	0.0	0.0
Total Non-Chlorinated Phenols	2.16 UG/L		82.7	94.3	82.6	94.6
Total Phenols	2.16 UG/L		82.7	94.3	82.6	94.6

Additional analytes determined

2-Methylphenol	2.15 UG/L		ND	ND	ND	ND
3-Methylphenol(4-MP is unresolved)	UG/L		NA	NA	NA	NA
4-Methylphenol(3-MP is unresolved)	2.11 UG/L		165	181	137	208
2,4,5-Trichlorophenol	1.66 UG/L		ND	ND	ND	ND

ND= not detected  
NA= not analyzed

SOUTH BAY WATER RECLAMATION PLANT  
ACID EXTRACTABLE COMPOUNDS, EPA Method 625

Annual 2013

Source:		REC WATER	REC WATER	REC WATER	REC WATER
Date:		05-FEB-2013	07-MAY-2013	06-AUG-2013	01-OCT-2013
Analyte	MDL Units	P649759	P661225	P671234	P677772
2-Chlorophenol	1.32 UG/L	ND	ND	ND	ND
2,4-Dichlorophenol	1.01 UG/L	ND	ND	ND	ND
4-Chloro-3-methylphenol	1.67 UG/L	ND	ND	ND	ND
2,4,6-Trichlorophenol	1.65 UG/L	ND	ND	ND	ND
Pentachlorophenol	1.12 UG/L	ND	ND	ND	ND
Phenol	1.76 UG/L	ND	ND	ND	ND
2-Nitrophenol	1.55 UG/L	ND	ND	ND	ND
2,4-Dimethylphenol	2.01 UG/L	ND	ND	ND	ND
2,4-Dinitrophenol	2.16 UG/L	ND	ND	ND	ND
4-Nitrophenol	1.14 UG/L	ND	ND	ND	ND
2-Methyl-4,6-dinitrophenol	1.52 UG/L	ND	ND	ND	ND
=====					
Total Chlorinated Phenols	1.67 UG/L	0.0	0.0	0.0	0.0
Total Non-Chlorinated Phenols	2.16 UG/L	0.0	0.0	0.0	0.0
=====					
Total Phenols	2.16 UG/L	0.0	0.0	0.0	0.0

Additional analytes determined

Analyte	MDL Units	P649759	P661225	P671234	P677772
2-Methylphenol	2.15 UG/L	ND	ND	ND	ND
3-Methylphenol(4-MP is unresolved)	UG/L	NA	NA	NA	NA
4-Methylphenol(3-MP is unresolved)	2.11 UG/L	ND	ND	ND	ND
2,4,5-Trichlorophenol	1.66 UG/L	ND	ND	ND	ND

ND= not detected  
NA= not analyzed

SOUTH BAY WATER RECLAMATION PLANT  
Priority Pollutants Purgeable Compounds, EPA Method 624 & 8260B

Annual 2013

Source: Date: Analyte	MDL Units	SB_INF_02 05-FEB-2013 P649726	SB_INF_02 07-MAY-2013 P661194	SB_INF_02 06-AUG-2013 P671201	SB_INF_02 01-OCT-2013 P677741
Acrolein	1.3 UG/L	ND	ND	ND	ND
Acrylonitrile	.7 UG/L	ND	ND	ND	ND
Benzene	.4 UG/L	ND	ND	ND	ND
Bromodichloromethane	.5 UG/L	ND	ND	ND	ND
Bromoform	.5 UG/L	ND	ND	ND	ND
Bromomethane	.7 UG/L	ND	ND	ND	ND
Carbon tetrachloride	.4 UG/L	ND	ND	ND	ND
Chlorobenzene	.4 UG/L	ND	ND	ND	ND
Chloroethane	.9 UG/L	ND	ND	ND	ND
2-Chloroethylvinyl ether	1.1 UG/L	ND	ND	ND	ND
Chloroform	.2 UG/L	2.9	7.0	1.7	1.2
Chloromethane	.5 UG/L	ND	ND	ND	ND
Dibromochloromethane	.6 UG/L	ND	ND	ND	ND
1,2-Dichlorobenzene	.4 UG/L	ND	ND	ND	ND
1,3-Dichlorobenzene	.5 UG/L	ND	ND	ND	ND
1,4-Dichlorobenzene	.4 UG/L	0.43*	DNQ0.7	DNQ0.5	DNQ0.5
Dichlorodifluoromethane	.66 UG/L	ND	ND	ND	ND
1,1-Dichloroethane	.4 UG/L	ND	ND	ND	ND
1,2-Dichloroethane	.5 UG/L	ND	ND	ND	ND
1,1-Dichloroethene	.4 UG/L	ND	ND	ND	ND
trans-1,2-dichloroethene	.6 UG/L	ND	ND	ND	ND
1,2-Dichloropropane	.3 UG/L	ND	ND	ND	ND
cis-1,3-dichloropropene	.3 UG/L	ND	ND	ND	ND
trans-1,3-dichloropropene	.5 UG/L	ND	ND	ND	ND
Ethylbenzene	.3 UG/L	ND	ND	ND	ND
Methylene chloride	.3 UG/L	ND	ND	2.5	ND
1,1,2,2-Tetrachloroethane	.5 UG/L	ND	ND	ND	ND
Tetrachloroethene	1.1 UG/L	ND	ND	ND	ND
Toluene	.4 UG/L	DNQ0.6	DNQ1.0	DNQ0.6	2.8
1,1,1-Trichloroethane	.4 UG/L	ND	ND	ND	ND
1,1,2-Trichloroethane	.5 UG/L	ND	ND	ND	ND
Trichloroethene	.7 UG/L	ND	ND	ND	ND
Trichlorofluoromethane	.3 UG/L	ND	ND	ND	ND
Vinyl chloride	.4 UG/L	ND	ND	ND	ND
1,2,4-Trichlorobenzene	.7 UG/L	ND	ND	ND	ND
Halomethane Purgeable Cmpnds	.7 UG/L	0.0	0.0	0.0	0.0
Total Dichlorobenzenes	.5 UG/L	0.0	0.0	0.0	0.0
Total Chloromethanes	.5 UG/L	2.9	7.0	1.7	1.2
Purgeable Compounds	1.3 UG/L	2.9	7.0	4.2	4.0

Additional Analytes Determined

Acetone	4.5 UG/L	135	175	196	290
Allyl chloride	.6 UG/L	ND	ND	ND	ND
Benzyl chloride	1.1 UG/L	ND	ND	ND	ND
1,2-Dibromoethane	.3 UG/L	ND	ND	ND	ND
2-Butanone	6.3 UG/L	ND	ND	ND	ND
Carbon disulfide	.6 UG/L	1.5	1.6	1.2	1.7
Chloroprene	.4 UG/L	ND	ND	ND	ND
Isopropylbenzene	.3 UG/L	ND	ND	ND	ND
Methyl Iodide	.6 UG/L	ND	ND	ND	ND
Methyl methacrylate	.8 UG/L	ND	ND	ND	ND
4-Methyl-2-pentanone	1.3 UG/L	ND	ND	ND	ND
meta,para xylenes	.6 UG/L	ND	ND	ND	ND
Methyl tert-butyl ether	.4 UG/L	ND	ND	ND	ND
2-Nitropropane	12 UG/L	ND	ND	ND	ND
ortho-xylene	.4 UG/L	ND	ND	ND	ND
Styrene	.3 UG/L	ND	ND	DNQ0.9	ND

ND= not detected

\*= Blank did not meet QC criteria for this analyte due to contamination. Result is not used in computations.

DNQ= Detected not quantifiable, result value less than minimum level (ML) but greater or equal MDL.



SOUTH BAY WATER RECLAMATION PLANT  
Priority Pollutants Purgeable Compounds, EPA Method 624 & 8260B

Annual 2013

Source:		SB_OUTFALL_01	SB_OUTFALL_01	SB_OUTFALL_01	SB_OUTFALL_01
Date:		05-FEB-2013	07-MAY-2013	06-AUG-2013	01-OCT-2013
Analyte	MDL Units	P649731	P661199	P671206	P677746
Acrolein	1.3 UG/L	ND	ND	ND	ND
Acrylonitrile	.7 UG/L	ND	ND	ND	ND
Benzene	.4 UG/L	ND	ND	ND	ND
Bromodichloromethane	.5 UG/L	ND	ND	ND	ND
Bromoform	.5 UG/L	ND	ND	ND	ND
Bromomethane	.7 UG/L	ND	ND	ND	ND
Carbon tetrachloride	.4 UG/L	ND	ND	ND	ND
Chlorobenzene	.4 UG/L	ND	ND	ND	ND
Chloroethane	.9 UG/L	ND	ND	ND	ND
2-Chloroethylvinyl ether	1.1 UG/L	ND	ND	ND	ND
Chloroform	.2 UG/L	ND	ND	ND	DNQ0.8
Chloromethane	.5 UG/L	ND	ND	ND	ND
Dibromochloromethane	.6 UG/L	ND	ND	ND	ND
1,2-Dichlorobenzene	.4 UG/L	ND	ND	ND	ND
1,3-Dichlorobenzene	.5 UG/L	ND	ND	ND	ND
1,4-Dichlorobenzene	.4 UG/L	0.49*	ND	ND	ND
Dichlorodifluoromethane	.66 UG/L	ND	ND	ND	ND
1,1-Dichloroethane	.4 UG/L	ND	ND	ND	ND
1,2-Dichloroethane	.5 UG/L	ND	ND	ND	ND
1,1-Dichloroethene	.4 UG/L	ND	ND	ND	ND
trans-1,2-dichloroethene	.6 UG/L	ND	ND	ND	ND
1,2-Dichloropropane	.3 UG/L	ND	ND	ND	ND
cis-1,3-dichloropropene	.3 UG/L	ND	ND	ND	ND
trans-1,3-dichloropropene	.5 UG/L	ND	ND	ND	ND
Ethylbenzene	.3 UG/L	ND	ND	ND	ND
Methylene chloride	.3 UG/L	ND	ND	ND	ND
1,1,2,2-Tetrachloroethane	.5 UG/L	ND	ND	ND	ND
Tetrachloroethene	1.1 UG/L	ND	ND	ND	ND
Toluene	.4 UG/L	ND	ND	ND	ND
1,1,1-Trichloroethane	.4 UG/L	ND	ND	ND	ND
1,1,2-Trichloroethane	.5 UG/L	ND	ND	ND	ND
Trichloroethene	.7 UG/L	ND	ND	ND	ND
Trichlorofluoromethane	.3 UG/L	ND	ND	ND	ND
Vinyl chloride	.4 UG/L	ND	ND	ND	ND
1,2,4-Trichlorobenzene	.7 UG/L	ND	ND	ND	ND
Halomethane Purgeable Cmpnds	.7 UG/L	0.0	0.0	0.0	0.0
Total Dichlorobenzenes	.5 UG/L	0.0	0.0	0.0	0.0
Total Chloromethanes	.5 UG/L	0.0	0.0	0.0	0.0
Purgeable Compounds	1.3 UG/L	0.0	0.0	0.0	0.0

Additional Analytes Determined

Acetone	4.5 UG/L	ND	ND	ND	ND
Allyl chloride	.6 UG/L	ND	ND	ND	ND
Benzyl chloride	1.1 UG/L	ND	ND	ND	ND
1,2-Dibromoethane	.3 UG/L	ND	ND	ND	ND
2-Butanone	6.3 UG/L	ND	ND	ND	ND
Carbon disulfide	.6 UG/L	ND	ND	ND	ND
Chloroprene	.4 UG/L	ND	ND	ND	ND
Isopropylbenzene	.3 UG/L	ND	ND	ND	ND
Methyl Iodide	.6 UG/L	ND	ND	ND	ND
Methyl methacrylate	.8 UG/L	ND	ND	ND	ND
4-Methyl-2-pentanone	1.3 UG/L	ND	ND	ND	ND
meta,para xylenes	.6 UG/L	ND	ND	ND	ND
Methyl tert-butyl ether	.4 UG/L	ND	ND	ND	ND
2-Nitropropane	12 UG/L	ND	ND	ND	ND
ortho-xylene	.4 UG/L	ND	ND	ND	ND
Styrene	.3 UG/L	ND	ND	ND	ND

ND= not detected

\*= Blank did not meet QC criteria for this analyte due to contamination. Result is not used in computations.

DNQ= Detected not quantifiable, result value less than minimum level (ML) but greater or equal MDL.

SOUTH BAY WATER RECLAMATION PLANT  
Priority Pollutants Purgeable Compounds, EPA Method 624 & 8260B

Annual 2013

Source:		SB_ITP_COMB_EFF	SB_ITP_COMB_EFF	SB_ITP_COMB_EFF	SB_ITP_COMB_EFF
Date:		05-FEB-2013	07-MAY-2013	06-AUG-2013	01-OCT-2013
Analyte	MDL Units	P649736	P661204	P671211	P677751
Acrolein	1.3 UG/L	ND	ND	ND	ND
Acrylonitrile	.7 UG/L	ND	ND	ND	ND
Benzene	.4 UG/L	ND	ND	ND	ND
Bromodichloromethane	.5 UG/L	1.6	1.4	ND	ND
Bromoform	.5 UG/L	ND	ND	ND	ND
Bromomethane	.7 UG/L	ND	ND	ND	ND
Carbon tetrachloride	.4 UG/L	ND	ND	ND	ND
Chlorobenzene	.4 UG/L	ND	ND	ND	ND
Chloroethane	.9 UG/L	ND	ND	ND	ND
2-Chloroethylvinyl ether	1.1 UG/L	ND	ND	ND	ND
Chloroform	.2 UG/L	3.4	2.0	ND	1.5
Chloromethane	.5 UG/L	ND	ND	ND	ND
Dibromochloromethane	.6 UG/L	DNQ0.9	1.0	ND	ND
1,2-Dichlorobenzene	.4 UG/L	ND	ND	ND	ND
1,3-Dichlorobenzene	.5 UG/L	ND	ND	ND	ND
1,4-Dichlorobenzene	.4 UG/L	1.2*	1.4	DNQ1.0	DNQ1.2
Dichlorodifluoromethane	.66 UG/L	ND	ND	ND	ND
1,1-Dichloroethane	.4 UG/L	ND	ND	ND	ND
1,2-Dichloroethane	.5 UG/L	ND	ND	ND	ND
1,1-Dichloroethene	.4 UG/L	ND	ND	ND	ND
trans-1,2-dichloroethene	.6 UG/L	ND	ND	ND	ND
1,2-Dichloropropane	.3 UG/L	ND	ND	ND	ND
cis-1,3-dichloropropene	.3 UG/L	ND	ND	ND	ND
trans-1,3-dichloropropene	.5 UG/L	ND	ND	ND	ND
Ethylbenzene	.3 UG/L	ND	ND	ND	ND
Methylene chloride	.3 UG/L	ND	ND	ND	ND
1,1,2,2-Tetrachloroethane	.5 UG/L	ND	ND	ND	ND
Tetrachloroethene	1.1 UG/L	ND	ND	ND	ND
Toluene	.4 UG/L	ND	1.5	ND	ND
1,1,1-Trichloroethane	.4 UG/L	ND	ND	ND	ND
1,1,2-Trichloroethane	.5 UG/L	ND	ND	ND	ND
Trichloroethene	.7 UG/L	ND	ND	ND	ND
Trichlorofluoromethane	.3 UG/L	ND	ND	ND	ND
Vinyl chloride	.4 UG/L	ND	ND	ND	ND
1,2,4-Trichlorobenzene	.7 UG/L	ND	ND	ND	ND
Halomethane Purgeable Cmpnds	.7 UG/L	0.0	0.0	0.0	0.0
Total Dichlorobenzenes	.5 UG/L	0.0	0.0	0.0	0.0
Total Chloromethanes	.5 UG/L	3.4	2.0	0.0	1.5
Purgeable Compounds	1.3 UG/L	5.0	7.3	0.0	1.5

Additional Analytes Determined

Acetone	4.5 UG/L	ND	ND	ND	ND
Allyl chloride	.6 UG/L	ND	ND	ND	ND
Benzyl chloride	1.1 UG/L	ND	ND	ND	ND
1,2-Dibromoethane	.3 UG/L	ND	ND	ND	ND
2-Butanone	6.3 UG/L	ND	ND	ND	ND
Carbon disulfide	.6 UG/L	ND	ND	ND	ND
Chloroprene	.4 UG/L	ND	ND	ND	ND
Isopropylbenzene	.3 UG/L	ND	ND	ND	ND
Methyl Iodide	.6 UG/L	ND	ND	ND	ND
Methyl methacrylate	.8 UG/L	ND	ND	ND	ND
4-Methyl-2-pentanone	1.3 UG/L	ND	ND	ND	ND
meta,para xylenes	.6 UG/L	ND	ND	ND	ND
Methyl tert-butyl ether	.4 UG/L	ND	ND	ND	ND
2-Nitropropane	12 UG/L	ND	ND	ND	ND
ortho-xylene	.4 UG/L	ND	ND	ND	ND
Styrene	.3 UG/L	ND	ND	ND	ND

ND= not detected

\*= Blank did not meet QC criteria for this analyte due to contamination. Result is not used in computations.

DNQ= Detected not quantifiable, result value less than minimum level (ML) but greater or equal MDL.

SOUTH BAY WATER RECLAMATION PLANT  
Priority Pollutants Purgeable Compounds, EPA Method 624 & 8260B

Annual 2013

Source:		SB_SEC_EFF_20	SB_SEC_EFF_20	SB_SEC_EFF_20	SB_SEC_EFF_20
Date:		05-FEB-2013	07-MAY-2013	06-AUG-2013	01-OCT-2013
Analyte	MDL Units	P649746	P661214	P671221	P677761
Acrolein	1.3 UG/L	ND	ND	ND	ND
Acrylonitrile	.7 UG/L	ND	ND	ND	ND
Benzene	.4 UG/L	ND	ND	ND	ND
Bromodichloromethane	.5 UG/L	ND	ND	ND	ND
Bromoform	.5 UG/L	ND	ND	ND	ND
Bromomethane	.7 UG/L	ND	ND	ND	ND
Carbon tetrachloride	.4 UG/L	ND	ND	ND	ND
Chlorobenzene	.4 UG/L	ND	ND	ND	ND
Chloroethane	.9 UG/L	ND	ND	ND	ND
2-Chloroethylvinyl ether	1.1 UG/L	ND	ND	ND	ND
Chloroform	.2 UG/L	ND	ND	ND	ND
Chloromethane	.5 UG/L	ND	ND	ND	ND
Dibromochloromethane	.6 UG/L	ND	ND	ND	ND
1,2-Dichlorobenzene	.4 UG/L	ND	ND	ND	ND
1,3-Dichlorobenzene	.5 UG/L	ND	ND	ND	ND
1,4-Dichlorobenzene	.4 UG/L	ND	ND	ND	ND
Dichlorodifluoromethane	.66 UG/L	ND	ND	ND	ND
1,1-Dichloroethane	.4 UG/L	ND	ND	ND	ND
1,2-Dichloroethane	.5 UG/L	ND	ND	ND	ND
1,1-Dichloroethene	.4 UG/L	ND	ND	ND	ND
trans-1,2-dichloroethene	.6 UG/L	ND	ND	ND	ND
1,2-Dichloropropane	.3 UG/L	ND	ND	ND	ND
cis-1,3-dichloropropene	.3 UG/L	ND	ND	ND	ND
trans-1,3-dichloropropene	.5 UG/L	ND	ND	ND	ND
Ethylbenzene	.3 UG/L	ND	ND	ND	ND
Methylene chloride	.3 UG/L	ND	ND	ND	ND
1,1,2,2-Tetrachloroethane	.5 UG/L	ND	ND	ND	ND
Tetrachloroethene	1.1 UG/L	ND	ND	ND	ND
Toluene	.4 UG/L	ND	ND	ND	ND
1,1,1-Trichloroethane	.4 UG/L	ND	ND	ND	ND
1,1,2-Trichloroethane	.5 UG/L	ND	ND	ND	ND
Trichloroethene	.7 UG/L	ND	ND	ND	ND
Trichlorofluoromethane	.3 UG/L	ND	ND	ND	ND
Vinyl chloride	.4 UG/L	ND	ND	ND	ND
1,2,4-Trichlorobenzene	.7 UG/L	ND	ND	ND	ND
Halomethane Purgeable Cmpnds	.7 UG/L	0.0	0.0	0.0	0.0
Total Dichlorobenzenes	.5 UG/L	0.0	0.0	0.0	0.0
Total Chloromethanes	.5 UG/L	0.0	0.0	0.0	0.0
Purgeable Compounds	1.3 UG/L	0.0	0.0	0.0	0.0
Additional Analytes Determined					
Acetone	4.5 UG/L	ND	ND	ND	ND
Allyl chloride	.6 UG/L	ND	ND	ND	ND
Benzyl chloride	1.1 UG/L	ND	ND	ND	ND
1,2-Dibromoethane	.3 UG/L	ND	ND	ND	ND
2-Butanone	6.3 UG/L	ND	ND	ND	ND
Carbon disulfide	.6 UG/L	ND	ND	ND	ND
Chloroprene	.4 UG/L	ND	ND	ND	ND
Isopropylbenzene	.3 UG/L	ND	ND	ND	ND
Methyl Iodide	.6 UG/L	ND	ND	ND	ND
Methyl methacrylate	.8 UG/L	ND	ND	ND	ND
4-Methyl-2-pentanone	1.3 UG/L	ND	ND	ND	ND
meta,para xylenes	.6 UG/L	ND	ND	ND	ND
Methyl tert-butyl ether	.4 UG/L	ND	ND	ND	ND
2-Nitropropane	12 UG/L	ND	ND	ND	ND
ortho-xylene	.4 UG/L	ND	ND	ND	ND
Styrene	.3 UG/L	ND	ND	ND	ND

ND= not detected

SOUTH BAY WATER RECLAMATION PLANT  
Priority Pollutants Purgeable Compounds, EPA Method 624 & 8260B

Annual 2013

Source:		SB_REC_WATER_34	SB_REC_WATER_34	SB_REC_WATER_34	SB_REC_WATER_34
Date:		05-FEB-2013	07-MAY-2013	06-AUG-2013	01-OCT-2013
Analyte	MDL Units	P649762	P661228	P671237	P677775
Acrolein	1.3 UG/L	ND	ND	ND	ND
Acrylonitrile	.7 UG/L	ND	ND	ND	ND
Benzene	.4 UG/L	ND	ND	ND	ND
Bromodichloromethane	.5 UG/L	ND	33.9	ND	9.6
Bromoform	.5 UG/L	ND	3.0	ND	ND
Bromomethane	.7 UG/L	ND	ND	ND	ND
Carbon tetrachloride	.4 UG/L	ND	ND	ND	ND
Chlorobenzene	.4 UG/L	ND	ND	ND	ND
Chloroethane	.9 UG/L	ND	ND	ND	ND
2-Chloroethylvinyl ether	1.1 UG/L	ND	ND	ND	ND
Chloroform	.2 UG/L	DNQ0.5	25.3	DNQ0.4	14.0
Chloromethane	.5 UG/L	ND	ND	ND	ND
Dibromochloromethane	.6 UG/L	ND	20.2	ND	4.1
1,2-Dichlorobenzene	.4 UG/L	ND	ND	ND	ND
1,3-Dichlorobenzene	.5 UG/L	ND	ND	ND	ND
1,4-Dichlorobenzene	.4 UG/L	ND	ND	ND	ND
Dichlorodifluoromethane	.66 UG/L	ND	ND	ND	ND
1,1-Dichloroethane	.4 UG/L	ND	ND	ND	ND
1,2-Dichloroethane	.5 UG/L	ND	ND	ND	ND
1,1-Dichloroethene	.4 UG/L	ND	ND	ND	ND
trans-1,2-dichloroethene	.6 UG/L	ND	ND	ND	ND
1,2-Dichloropropane	.3 UG/L	ND	ND	ND	ND
cis-1,3-dichloropropene	.3 UG/L	ND	ND	ND	ND
trans-1,3-dichloropropene	.5 UG/L	ND	ND	ND	ND
Ethylbenzene	.3 UG/L	ND	ND	ND	ND
Methylene chloride	.3 UG/L	ND	ND	DNQ0.4	DNQ0.4
1,1,2,2-Tetrachloroethane	.5 UG/L	ND	ND	ND	ND
Tetrachloroethene	1.1 UG/L	ND	ND	ND	ND
Toluene	.4 UG/L	ND	ND	ND	ND
1,1,1-Trichloroethane	.4 UG/L	ND	ND	ND	ND
1,1,2-Trichloroethane	.5 UG/L	ND	ND	ND	ND
Trichloroethene	.7 UG/L	ND	ND	ND	ND
Trichlorofluoromethane	.3 UG/L	ND	ND	ND	ND
Vinyl chloride	.4 UG/L	ND	ND	ND	ND
1,2,4-Trichlorobenzene	.7 UG/L	ND	ND	ND	ND
Halomethane Purgeable Cmpnds	.7 UG/L	0.0	3.0	0.0	0.0
Total Dichlorobenzenes	.5 UG/L	0.0	0.0	0.0	0.0
Total Chloromethanes	.5 UG/L	0.0	25.3	0.0	14.0
Purgeable Compounds	1.3 UG/L	0.0	82.4	0.0	27.7

Additional Analytes Determined

Acetone	4.5 UG/L	ND	DNQ6.1	ND	ND
Allyl chloride	.6 UG/L	ND	ND	ND	ND
Benzyl chloride	1.1 UG/L	ND	ND	ND	ND
1,2-Dibromoethane	.3 UG/L	ND	ND	ND	ND
2-Butanone	6.3 UG/L	ND	ND	ND	ND
Carbon disulfide	.6 UG/L	ND	ND	ND	ND
Chloroprene	.4 UG/L	ND	ND	ND	ND
Isopropylbenzene	.3 UG/L	ND	ND	ND	ND
Methyl Iodide	.6 UG/L	ND	ND	ND	ND
Methyl methacrylate	.8 UG/L	ND	ND	ND	ND
4-Methyl-2-pentanone	1.3 UG/L	ND	ND	ND	ND
meta,para xylenes	.6 UG/L	ND	ND	ND	ND
Methyl tert-butyl ether	.4 UG/L	ND	ND	ND	ND
2-Nitropropane	12 UG/L	ND	ND	ND	ND
ortho-xylene	.4 UG/L	ND	ND	ND	ND
Styrene	.3 UG/L	ND	ND	ND	ND

ND= not detected

DNQ= Detected not quantifiable, result value less than minimum level (ML) but greater or equal MDL.

SOUTH BAY WATER RECLAMATION PLANT  
Priority Pollutants Purgeable Compounds, EPA Method 624 & 8260B

Annual 2013

Source:		SB_PRIEFF_10	SB_PRIEFF_10	SB_PRIEFF_10	SB_PRIEFF_10
Date:		05-FEB-2013	07-MAY-2013	06-AUG-2013	01-OCT-2013
Analyte	MDL Units	P649741	P661209	P671216^	P677756
Acrolein	1.3 UG/L	ND	ND	ND	ND
Acrylonitrile	.7 UG/L	ND	ND	ND	ND
Benzene	.4 UG/L	ND	ND	ND	ND
Bromodichloromethane	.5 UG/L	ND	ND	ND	ND
Bromoform	.5 UG/L	ND	ND	ND	ND
Bromomethane	.7 UG/L	ND	ND	ND	ND
Carbon tetrachloride	.4 UG/L	ND	ND	ND	ND
Chlorobenzene	.4 UG/L	ND	ND	ND	ND
Chloroethane	.9 UG/L	ND	ND	ND	ND
2-Chloroethylvinyl ether	1.1 UG/L	ND	ND	ND	ND
Chloroform	.2 UG/L	DNQ0.6	3.3	DNQ0.7	DNQ0.9
Chloromethane	.5 UG/L	ND	ND	ND	ND
Dibromochloromethane	.6 UG/L	ND	ND	ND	ND
1,2-Dichlorobenzene	.4 UG/L	ND	ND	ND	ND
1,3-Dichlorobenzene	.5 UG/L	ND	ND	ND	ND
1,4-Dichlorobenzene	.4 UG/L	ND	ND	ND	ND
Dichlorodifluoromethane	.66 UG/L	ND	ND	ND	ND
1,1-Dichloroethane	.4 UG/L	ND	ND	ND	ND
1,2-Dichloroethane	.5 UG/L	ND	ND	ND	ND
1,1-Dichloroethene	.4 UG/L	ND	ND	ND	ND
trans-1,2-dichloroethene	.6 UG/L	ND	ND	ND	ND
1,2-Dichloropropane	.3 UG/L	ND	ND	ND	ND
cis-1,3-dichloropropene	.3 UG/L	ND	ND	ND	ND
trans-1,3-dichloropropene	.5 UG/L	ND	ND	ND	ND
Ethylbenzene	.3 UG/L	ND	ND	ND	ND
Methylene chloride	.3 UG/L	ND	ND	29.5	ND
1,1,2,2-Tetrachloroethane	.5 UG/L	ND	ND	ND	ND
Tetrachloroethene	1.1 UG/L	ND	ND	ND	ND
Toluene	.4 UG/L	ND	DNQ0.6	ND	ND
1,1,1-Trichloroethane	.4 UG/L	ND	ND	ND	ND
1,1,2-Trichloroethane	.5 UG/L	ND	ND	ND	ND
Trichloroethene	.7 UG/L	ND	ND	ND	ND
Trichlorofluoromethane	.3 UG/L	ND	ND	ND	ND
Vinyl chloride	.4 UG/L	ND	ND	ND	ND
1,2,4-Trichlorobenzene	.7 UG/L	ND	ND	ND	ND
Halomethane Purgeable Cmpnds	.7 UG/L	0.0	0.0	0.0	0.0
Total Dichlorobenzenes	.5 UG/L	0.0	0.0	0.0	0.0
Total Chloromethanes	.5 UG/L	0.0	3.3	0.0	0.0
Purgeable Compounds	1.3 UG/L	0.0	3.3	29.5	0.0

Additional Analytes Determined

Acetone	4.5 UG/L	118	292	481	744
Allyl chloride	.6 UG/L	ND	ND	ND	ND
Benzyl chloride	1.1 UG/L	ND	ND	ND	ND
1,2-Dibromoethane	.3 UG/L	ND	ND	ND	ND
2-Butanone	6.3 UG/L	ND	ND	ND	ND
Carbon disulfide	.6 UG/L	ND	1.2	1.0	1.9
Chloroprene	.4 UG/L	ND	ND	ND	ND
Isopropylbenzene	.3 UG/L	ND	ND	ND	ND
Methyl Iodide	.6 UG/L	ND	ND	ND	ND
Methyl methacrylate	.8 UG/L	ND	ND	ND	ND
4-Methyl-2-pentanone	1.3 UG/L	ND	ND	ND	ND
meta,para xylenes	.6 UG/L	ND	ND	ND	ND
Methyl tert-butyl ether	.4 UG/L	ND	ND	ND	ND
2-Nitropropane	12 UG/L	ND	ND	ND	ND
ortho-xylene	.4 UG/L	ND	ND	ND	ND
Styrene	.3 UG/L	ND	ND	0.7	ND

^= This is a non-reportable sample, two surrogates recoveries were out the control limits.

ND= not detected

DNQ= Detected not quantifiable, result value less than minimum level (ML) but greater or equal MDL.

SOUTH BAY WATER RECLAMATION PLANT  
Priority Pollutants Purgeable Compounds, EPA Method 624 & 8260B

Annual 2013

Analyte	MDL Units	SB_RSL_10_B	SB_RSL_10_B	SB_RSL_10_B	SB_RSL_10_B
		20-FEB-2013 P652769	07-MAY-2013 P661223	06-AUG-2013 P671232	01-OCT-2013 P677770
Acrolein	1.3 UG/L	ND	ND	ND	ND
Acrylonitrile	.7 UG/L	ND	ND	ND	ND
Benzene	.4 UG/L	ND	ND	ND	ND
Bromodichloromethane	.5 UG/L	ND	ND	ND	ND
Bromoform	.5 UG/L	ND	ND	ND	ND
Bromomethane	.7 UG/L	ND	ND	ND	ND
Carbon tetrachloride	.4 UG/L	ND	ND	ND	ND
Chlorobenzene	.4 UG/L	ND	ND	ND	ND
Chloroethane	.9 UG/L	ND	ND	ND	ND
2-Chloroethylvinyl ether	1.1 UG/L	ND	ND	ND	ND
Chloroform	.2 UG/L	1.2	2.5	1.8	1.7
Chloromethane	.5 UG/L	ND	ND	ND	ND
Dibromochloromethane	.6 UG/L	ND	ND	ND	ND
1,2-Dichlorobenzene	.4 UG/L	ND	ND	ND	ND
1,3-Dichlorobenzene	.5 UG/L	ND	ND	ND	ND
1,4-Dichlorobenzene	.4 UG/L	ND	1.5	1.4	DNQ0.6
Dichlorodifluoromethane	.66 UG/L	ND	ND	ND	ND
1,1-Dichloroethane	.4 UG/L	ND	ND	ND	ND
1,2-Dichloroethane	.5 UG/L	ND	ND	ND	ND
1,1-Dichloroethene	.4 UG/L	ND	ND	ND	ND
trans-1,2-dichloroethene	.6 UG/L	ND	ND	ND	ND
1,2-Dichloropropane	.3 UG/L	ND	ND	ND	ND
cis-1,3-dichloropropene	.3 UG/L	ND	ND	ND	ND
trans-1,3-dichloropropene	.5 UG/L	ND	ND	ND	ND
Ethylbenzene	.3 UG/L	ND	ND	DNQ0.4	ND
Methylene chloride	.3 UG/L	ND	14.6	3.9	DNQ0.9
1,1,2,2-Tetrachloroethane	.5 UG/L	ND	ND	ND	ND
Tetrachloroethene	1.1 UG/L	ND	ND	ND	ND
Toluene	.4 UG/L	6.0	2.0	2.4	1.3
1,1,1-Trichloroethane	.4 UG/L	ND	ND	ND	ND
1,1,2-Trichloroethane	.5 UG/L	ND	ND	ND	ND
Trichloroethene	.7 UG/L	ND	ND	ND	ND
Trichlorofluoromethane	.3 UG/L	ND	ND	ND	ND
Vinyl chloride	.4 UG/L	ND	ND	ND	ND
1,2,4-Trichlorobenzene	.7 UG/L	ND	ND	ND	ND
Halomethane Purgeable Cmpnds	.7 UG/L	0.0	0.0	0.0	0.0
Total Dichlorobenzenes	.5 UG/L	0.0	0.0	0.0	0.0
Total Chloromethanes	.5 UG/L	1.2	17.1	5.7	1.7
Purgeable Compounds	1.3 UG/L	7.2	20.6	9.5	3.0

Additional Analytes Determined

Acetone	4.5 UG/L	103	122	90.1	92.4
Allyl chloride	.6 UG/L	ND	ND	ND	ND
Benzyl chloride	1.1 UG/L	ND	ND	ND	ND
1,2-Dibromoethane	.3 UG/L	ND	ND	ND	ND
2-Butanone	6.3 UG/L	7.6	ND	ND	ND
Carbon disulfide	.6 UG/L	2.2	2.5	1.7	1.3
Chloroprene	.4 UG/L	ND	ND	ND	ND
Isopropylbenzene	.3 UG/L	ND	ND	ND	ND
Methyl Iodide	.6 UG/L	ND	ND	ND	ND
Methyl methacrylate	.8 UG/L	ND	ND	ND	ND
4-Methyl-2-pentanone	1.3 UG/L	ND	ND	ND	ND
meta,para xylenes	.6 UG/L	ND	DNQ1.2	DNQ1.6	ND
Methyl tert-butyl ether	.4 UG/L	ND	ND	ND	ND
2-Nitropropane	12 UG/L	ND	ND	ND	ND
ortho-xylene	.4 UG/L	ND	DNQ0.6	DNQ0.7	ND
Styrene	.3 UG/L	ND	ND	2.0	ND

ND= not detected

DNQ=Detected not quantifiable, result value less than minimum level (ML) but greater or equal MDL.

SOUTH BAY WATER RECLAMATION PLANT  
Tributyl Tin Analysis

Annual 2013

Source:		INFLUENT	INFLUENT	INFLUENT	INFLUENT	EFFLUENT	EFFLUENT	EFFLUENT
Sample ID:		P649723	P661191	P671198	P677738	P649728	P661196	P671203
Analyte	MDL Units	05-FEB-2013	07-MAY-2013	06-AUG-2013	01-OCT-2013	05-FEB-2013	07-MAY-2013	06-AUG-2013
Dibutyltin	7 UG/L	ND	ND	ND	ND	ND	ND	ND
Monobutyltin	16 UG/L	ND	ND	ND	ND	ND	ND	ND
Tributyltin	2 UG/L	ND	ND	ND	ND	ND	ND	ND

Source:		EFFLUENT	COMB EFF	COMB EFF	COMB EFF	COMB EFF	PRI EFF	PRI EFF
Sample ID:		P677743	P649733	P661201	P671208	P677748	P649738	P661206
Analyte	MDL Units	01-OCT-2013	05-FEB-2013	09-MAY-2013	06-AUG-2013	01-OCT-2013	05-FEB-2013	07-MAY-2013
Dibutyltin	7 UG/L	ND	ND	ND	ND	ND	ND	ND
Monobutyltin	16 UG/L	ND	ND	ND	ND	ND	ND	ND
Tributyltin	2 UG/L	ND	ND	ND	ND	ND	ND	ND

Source:		PRI EFF	PRI EFF	SEC EFF	SEC EFF	SEC EFF	SEC EFF	REC WATER
Sample ID:		P671213	P677753	P649743	P661211	P671218	P677758	P649759
Analyte	MDL Units	06-AUG-2013	01-OCT-2013	05-FEB-2013	07-MAY-2013	06-AUG-2013	01-OCT-2013	05-FEB-2013
Dibutyltin	7 UG/L	ND	ND	ND	ND	ND	ND	ND
Monobutyltin	16 UG/L	ND	ND	ND	ND	ND	ND	ND
Tributyltin	2 UG/L	ND	ND	ND	ND	ND	ND	ND

Source:		REC WATER	REC WATER	REC WATER
Sample ID:		P661225	P671234	P677772
Analyte	MDL Units	07-MAY-2013	06-AUG-2013	01-OCT-2013
Dibutyltin	7 UG/L	ND	ND	ND
Monobutyltin	16 UG/L	ND	ND	ND
Tributyltin	2 UG/L	ND	ND	ND

ND=not detected

SOUTH BAY WATER RECLAMATION PLANT  
Dioxin and Furan Analysis

Annual 2013

Source:				INFLUENT	INFLUENT	EFFLUENT	EFFLUENT
Date:				TCDD			
Analytes	MDL	Units	Equiv.	05-FEB-2013	05-FEB-2013	05-FEB-2013	05-FEB-2013
				P649723	P649723	P649728	P649728
2,3,7,8-tetra CDD	.26	PG/L	1.000	ND	ND	ND	ND
1,2,3,7,8-penta CDD	.277	PG/L	0.500	ND	ND	ND	ND
1,2,3,4,7,8_hexa_CDD	.482	PG/L	0.100	ND	ND	ND	ND
1,2,3,6,7,8-hexa CDD	.484	PG/L	0.100	DNQ3.26	DNQ0.326	ND	ND
1,2,3,7,8,9-hexa CDD	.479	PG/L	0.100	ND	ND	ND	ND
1,2,3,4,6,7,8-hepta CDD	.53	PG/L	0.010	29.2	0.292	ND	ND
octa CDD	1.4	PG/L	0.001	130	0.130	DNQ5.19	DNQ0.005
2,3,7,8-tetra CDF	.257	PG/L	0.100	ND	ND	ND	ND
1,2,3,7,8-penta CDF	.335	PG/L	0.050	ND	ND	ND	ND
2,3,4,7,8-penta CDF	.34	PG/L	0.050	ND	ND	ND	ND
1,2,3,4,7,8-hexa CDF	.284	PG/L	0.100	ND	ND	ND	ND
1,2,3,6,7,8-hexa CDF	.281	PG/L	0.100	ND	ND	ND	ND
1,2,3,7,8,9-hexa CDF	.348	PG/L	0.100	ND	ND	ND	ND
2,3,4,6,7,8-hexa CDF	.294	PG/L	0.100	ND	ND	ND	ND
1,2,3,4,6,7,8-hepta CDF	.295	PG/L	0.010	DNQ2.08	DNQ0.021	ND	ND
1,2,3,4,7,8,9-hepta CDF	.397	PG/L	0.010	ND	ND	ND	ND
octa CDF	.738	PG/L	0.001	DNQ5.77	DNQ0.006	ND	ND

Source:				INFLUENT	INFLUENT	EFFLUENT	EFFLUENT
Date:				TCDD			
Analytes	MDL	Units	Equiv.	07-MAY-2013	07-MAY-2013	07-MAY-2013	07-MAY-2013
				P661191	P661191	P661196	P661196
2,3,7,8-tetra CDD	.26	PG/L	1.000	ND	ND	ND	ND
1,2,3,7,8-penta CDD	.277	PG/L	0.500	ND	ND	ND	ND
1,2,3,4,7,8_hexa_CDD	.482	PG/L	0.100	ND	ND	ND	ND
1,2,3,6,7,8-hexa CDD	.484	PG/L	0.100	ND	ND	ND	ND
1,2,3,7,8,9-hexa CDD	.479	PG/L	0.100	ND	ND	ND	ND
1,2,3,4,6,7,8-hepta CDD	.53	PG/L	0.010	24.3	0.243	ND	ND
octa CDD	1.4	PG/L	0.001	210	0.21	ND	ND
2,3,7,8-tetra CDF	.257	PG/L	0.100	ND	ND	ND	ND
1,2,3,7,8-penta CDF	.335	PG/L	0.050	ND	ND	ND	ND
2,3,4,7,8-penta CDF	.34	PG/L	0.050	ND	ND	ND	ND
1,2,3,4,7,8-hexa CDF	.284	PG/L	0.100	ND	ND	ND	ND
1,2,3,6,7,8-hexa CDF	.281	PG/L	0.100	ND	ND	ND	ND
1,2,3,7,8,9-hexa CDF	.348	PG/L	0.100	ND	ND	ND	ND
2,3,4,6,7,8-hexa CDF	.294	PG/L	0.100	ND	ND	ND	ND
1,2,3,4,6,7,8-hepta CDF	.295	PG/L	0.010	ND	ND	ND	ND
1,2,3,4,7,8,9-hepta CDF	.397	PG/L	0.010	ND	ND	ND	ND
octa CDF	.738	PG/L	0.001	DNQ8.2	DNQ0.008	ND	ND

ND= not detected

DNQ= (Detected but not quantified). Estimated analyte concentration below calibration range.



SOUTH BAY WATER RECLAMATION PLANT  
Dioxin and Furan Analysis

Annual 2013

Source:				INFLUENT	INFLUENT	EFFLUENT	EFFLUENT
Date:				TCDD			
Analytes	MDL	Units	Equiv.	06-AUG-2013	06-AUG-2013	06-AUG-2013	06-AUG-2013
				P671198	P671198	P671203	P671203
2,3,7,8-tetra CDD	.26	PG/L	1.000	ND	ND	ND	ND
1,2,3,7,8-penta CDD	.277	PG/L	0.500	ND	ND	ND	ND
1,2,3,4,7,8_hexa_CDD	.482	PG/L	0.100	ND	ND	ND	ND
1,2,3,6,7,8-hexa CDD	.484	PG/L	0.100	ND	ND	ND	ND
1,2,3,7,8,9-hexa CDD	.479	PG/L	0.100	ND	ND	ND	ND
1,2,3,4,6,7,8-hepta CDD	.53	PG/L	0.010	DNQ23	DNQ0.23	ND	ND
octa CDD	1.4	PG/L	0.001	130	0.13	ND	ND
2,3,7,8-tetra CDF	.257	PG/L	0.100	ND	ND	ND	ND
1,2,3,7,8-penta CDF	.335	PG/L	0.050	ND	ND	ND	ND
2,3,4,7,8-penta CDF	.34	PG/L	0.050	ND	ND	ND	ND
1,2,3,4,7,8-hexa CDF	.284	PG/L	0.100	ND	ND	ND	ND
1,2,3,6,7,8-hexa CDF	.281	PG/L	0.100	ND	ND	ND	ND
1,2,3,7,8,9-hexa CDF	.348	PG/L	0.100	ND	ND	ND	ND
2,3,4,6,7,8-hexa CDF	.294	PG/L	0.100	ND	ND	ND	ND
1,2,3,4,6,7,8-hepta CDF	.295	PG/L	0.010	DNQ3.54	DNQ0.035	ND	ND
1,2,3,4,7,8,9-hepta CDF	.397	PG/L	0.010	ND	ND	ND	ND
octa CDF	.738	PG/L	0.001	DNQ6.93	DNQ0.007	ND	ND

Source:				INFLUENT	INFLUENT	EFFLUENT	EFFLUENT
Date:				TCDD			
Analytes	MDL	Units	Equiv.	01-OCT-2013	01-OCT-2013	01-OCT-2013	01-OCT-2013
				P677738	P677738	P677743	P677743
2,3,7,8-tetra CDD	.26	PG/L	1.000	ND	ND	ND	ND
1,2,3,7,8-penta CDD	.277	PG/L	0.500	ND	ND	ND	ND
1,2,3,4,7,8_hexa_CDD	.482	PG/L	0.100	ND	ND	ND	ND
1,2,3,6,7,8-hexa CDD	.484	PG/L	0.100	ND	ND	ND	ND
1,2,3,7,8,9-hexa CDD	.479	PG/L	0.100	ND	ND	ND	ND
1,2,3,4,6,7,8-hepta CDD	.53	PG/L	0.010	DNQ14.8	DNQ0.148	ND	ND
octa CDD	1.4	PG/L	0.001	120	0.12	DNQ5.44	DNQ0.005
2,3,7,8-tetra CDF	.257	PG/L	0.100	ND	ND	ND	ND
1,2,3,7,8-penta CDF	.335	PG/L	0.050	ND	ND	ND	ND
2,3,4,7,8-penta CDF	.34	PG/L	0.050	ND	ND	ND	ND
1,2,3,4,7,8-hexa CDF	.284	PG/L	0.100	ND	ND	ND	ND
1,2,3,6,7,8-hexa CDF	.281	PG/L	0.100	ND	ND	ND	ND
1,2,3,7,8,9-hexa CDF	.348	PG/L	0.100	ND	ND	ND	ND
2,3,4,6,7,8-hexa CDF	.294	PG/L	0.100	ND	ND	ND	ND
1,2,3,4,6,7,8-hepta CDF	.295	PG/L	0.010	DNQ2.35	DNQ0.024	ND	ND
1,2,3,4,7,8,9-hepta CDF	.397	PG/L	0.010	ND	ND	ND	ND
octa CDF	.738	PG/L	0.001	DNQ6.87	DNQ0.007	ND	ND

ND= not detected

DNQ= (Detected but not quantified). Estimated analyte concentration below calibration range.

SOUTH BAY WATER RECLAMATION PLANT  
Dioxin and Furan Analysis

Annual 2013

Source:				COMB EFF	COMB EFF	COMB EFF	COMB EFF
Date:				TCDD			
Analytes	MDL	Units	Equiv.	05-FEB-2013	05-FEB-2013	09-MAY-2013	09-MAY-2013
				P649733	P649733	P661201	P661201
2,3,7,8-tetra CDD	.26	PG/L	1.000	ND	ND	ND	ND
1,2,3,7,8-penta CDD	.277	PG/L	0.500	ND	ND	ND	ND
1,2,3,4,7,8_hexa_CDD	.482	PG/L	0.100	ND	ND	ND	ND
1,2,3,6,7,8-hexa CDD	.484	PG/L	0.100	ND	ND	ND	ND
1,2,3,7,8,9-hexa CDD	.479	PG/L	0.100	ND	ND	ND	ND
1,2,3,4,6,7,8-hepta CDD	.53	PG/L	0.010	ND	ND	ND	ND
octa CDD	1.4	PG/L	0.001	DNQ5.78	DNQ0.006	ND	ND
2,3,7,8-tetra CDF	.257	PG/L	0.100	ND	ND	ND	ND
1,2,3,7,8-penta CDF	.335	PG/L	0.050	ND	ND	ND	ND
2,3,4,7,8-penta CDF	.34	PG/L	0.050	ND	ND	ND	ND
1,2,3,4,7,8-hexa CDF	.284	PG/L	0.100	ND	ND	ND	ND
1,2,3,6,7,8-hexa CDF	.281	PG/L	0.100	ND	ND	ND	ND
1,2,3,7,8,9-hexa CDF	.348	PG/L	0.100	ND	ND	ND	ND
2,3,4,6,7,8-hexa CDF	.294	PG/L	0.100	ND	ND	ND	ND
1,2,3,4,6,7,8-hepta CDF	.295	PG/L	0.010	ND	ND	ND	ND
1,2,3,4,7,8,9-hepta CDF	.397	PG/L	0.010	ND	ND	ND	ND
octa CDF	.738	PG/L	0.001	ND	ND	ND	ND

Source:				COMB EFF	COMB EFF	COMB EFF	COMB EFF
Date:				TCDD			
Analytes	MDL	Units	Equiv.	06-AUG-2013	06-AUG-2013	01-OCT-2013	01-OCT-2013
				P671208	P671208	P677748	P677748
2,3,7,8-tetra CDD	.26	PG/L	1.000	ND	ND	ND	ND
1,2,3,7,8-penta CDD	.277	PG/L	0.500	ND	ND	ND	ND
1,2,3,4,7,8_hexa_CDD	.482	PG/L	0.100	ND	ND	ND	ND
1,2,3,6,7,8-hexa CDD	.484	PG/L	0.100	ND	ND	ND	ND
1,2,3,7,8,9-hexa CDD	.479	PG/L	0.100	ND	ND	ND	ND
1,2,3,4,6,7,8-hepta CDD	.53	PG/L	0.010	ND	ND	ND	ND
octa CDD	1.4	PG/L	0.001	ND	ND	DNQ5.87	DNQ0.006
2,3,7,8-tetra CDF	.257	PG/L	0.100	ND	ND	ND	ND
1,2,3,7,8-penta CDF	.335	PG/L	0.050	ND	ND	ND	ND
2,3,4,7,8-penta CDF	.34	PG/L	0.050	ND	ND	ND	ND
1,2,3,4,7,8-hexa CDF	.284	PG/L	0.100	ND	ND	ND	ND
1,2,3,6,7,8-hexa CDF	.281	PG/L	0.100	ND	ND	ND	ND
1,2,3,7,8,9-hexa CDF	.348	PG/L	0.100	ND	ND	ND	ND
2,3,4,6,7,8-hexa CDF	.294	PG/L	0.100	ND	ND	ND	ND
1,2,3,4,6,7,8-hepta CDF	.295	PG/L	0.010	ND	ND	ND	ND
1,2,3,4,7,8,9-hepta CDF	.397	PG/L	0.010	ND	ND	ND	ND
octa CDF	.738	PG/L	0.001	ND	ND	ND	ND

ND= not detected

DNQ= (Detected but not quantified). Estimated analyte concentration below calibration range.

## VII. Reclaimed Water Data Summary.

The results of all analyses performed on Reclaimed water are summarized in tables with monthly and annual averages (and in some cases annual totals) calculated. Graphs of monthly averages are presented.

- A. Reclaimed Water Data Summaries
- B. Reclaimed Water Graphs
- C. Daily Values of Selected Parameters
- D. Total Coliforms Data Summaries
- E. UV Performance Report

This page left blank intentionally

A. Reclaimed Water Data Summaries

The results of all analyses performed on the SBWRP Reclaimed are summarized in tables with monthly and annual averages (and in some cases annual totals) calculated.

**South Bay Water Reclamation Plant**  
**Annual Recycled Water Turbidity Report 2013**  
 Data from in-plant meter

Month	1651 FLE AVG TURBIDITY NTU	1657 FLE MIN TURBIDITY NTU	1654 FLE MAX TURBIDITY NTU	1687 PCT. ABOVE 5 NTU (DURING RW DEL.) pct
Jan 2013	1.20	1.00	2.41	0.00
Feb 2013	1.10	0.98	1.77	0.00
Mar 2013	1.43	1.07	3.89	0.00
Apr 2013	0.98	0.68	3.11	0.00
May 2013	0.68	0.56	1.58	0.00
Jun 2013	0.89	0.68	2.27	0.00
Jul 2013	1.00	0.75	2.55	0.00
Aug 2013	0.55	0.47	1.00	0.00
Sep 2013	0.37	0.33	0.79	0.00
Oct 2013	0.64	0.54	1.02	0.00
Nov 2013	0.47	0.37	1.30	0.00
Dec 2013	0.56	0.47	1.28	0.00
Average	0.82	0.66	1.92	0.00

1657- Minimum Daily value is the average recorded value for the month.

1654- Maximum Daily value is the average recorded value for the month.

Compliance monitoring point, values taken from DCS Point(S29A10203), located at the UV Vault in Area 29 (Tertiary UV Disinfection System)

SOUTH BAY WATER RECLAMATION PLANT

Annual 2013

Reclaim Water  
(SB\_REC\_WATER\_34)

Analyte:	Flow	pH	Biochemical Oxygen Demand	Total Suspended Solids	Volatile Suspended Solids	Total Dissolved Solids	Turbidity*
Units:	(mgd)		(mg/L)	(mg/L)	(mg/L)	(mg/L)	(NTU)
JANUARY -2013	0.46	7.48	8	<1.4	<1.6	1000	NR
FEBRUARY -2013	0.72	7.38	5	<1.4	<1.6	970	1.34
MARCH -2013	1.54	7.43	5	<1.4	<1.6	1000	NR
APRIL -2013	3.05	7.48	<2	<1.4	<1.6	1010	NR
MAY -2013	3.84	7.47	2	<1.4	<1.6	1070	0.72
JUNE -2013	5.29	7.52	3	<1.4	<1.6	1090	NR
JULY -2013	5.19	7.50	4	1.4	<1.6	1060	NR
AUGUST -2013	5.63	7.41	3	1.4	<1.6	1090	1.17
SEPTEMBER -2013	5.51	7.44	2	2.8	2.5	960	NR
OCTOBER -2013	3.95	7.42	3	2.4	2.1	925	0.62
NOVEMBER -2013	1.97	7.37	<2	<1.4	<1.6	925	NR
DECEMBER -2013	1.24	7.38	<2	<1.4	<1.6	931	NR
Average	3.20	7.44	3	0.7	0.4	1003	0.96

\*= Not for compliance monitoring

ND=not detected  
NR=not required

SOUTH BAY WATER RECLAMATION PLANT  
SB\_REC\_WATER\_34 Reclaimed Water- Annual Averages

Annual 2013

Source:	Aluminum	Antimony	Arsenic	Barium	Beryllium	Boron
MDL:	47	2.9	.4	.039	.022	7
Units:	UG/L	UG/L	UG/L	UG/L	UG/L	UG/L
=====	=====	=====	=====	=====	=====	=====
JANUARY -2013	NR	NR	NR	NR	NR	291
FEBRUARY -2013	74	ND	0.6	45.2	ND	289
MARCH -2013	NR	NR	NR	NR	NR	297
APRIL -2013	NR	NR	NR	NR	NR	284
MAY -2013	117	ND	0.8	60.4	ND	331
JUNE -2013	NR	NR	NR	NR	NR	315
JULY -2013	NR	NR	NR	NR	NR	309
AUGUST -2013	95	ND	0.8	59.2	ND	289
SEPTEMBER-2013	NR	NR	NR	NR	NR	327
OCTOBER -2013	ND	ND	0.7	59.1	ND	282
NOVEMBER -2013	ND	ND	NR	57.1	ND	276
DECEMBER -2013	NR	NR	NR	NR	NR	284
=====	=====	=====	=====	=====	=====	=====
Annual Average:	57	ND	0.7	56.2	ND	298

Source:	Cadmium	Chromium	Copper	Iron	Manganese	Mercury
MDL:	.53	1.2	2	37	.24	.005
Units:	UG/L	UG/L	UG/L	UG/L	UG/L	UG/L
=====	=====	=====	=====	=====	=====	=====
JANUARY -2013	NR	NR	NR	87	44.7	NR
FEBRUARY -2013	ND	ND	10.0	64	22.9	ND
MARCH -2013	NR	NR	NR	ND	11.5	NR
APRIL -2013	NR	NR	NR	ND	14.6	NR
MAY -2013	ND	ND	8.5	85	8.5	ND
JUNE -2013	NR	NR	NR	80	32.8	NR
JULY -2013	NR	NR	NR	ND	37.8	NR
AUGUST -2013	ND	ND	7.5	49	34.8	ND
SEPTEMBER-2013	NR	NR	NR	55	13.6	NR
OCTOBER -2013	ND	2.22	7.4	53	6.9	ND
NOVEMBER -2013	ND	3.00	5.5	<37	14.7	NR
DECEMBER -2013	NR	NR	NR	41	13.8	NR
=====	=====	=====	=====	=====	=====	=====
Annual Average:	ND	1.04	7.8	43	21.4	ND

Source:	Nickel	Selenium	Thallium	Chloride	Fluoride	Sulfate
MDL:	.53	.28	3.9	7	.05	9
Units:	UG/L	UG/L	UG/L	MG/L	MG/L	MG/L
=====	=====	=====	=====	=====	=====	=====
JANUARY -2013	NR	NR	NR	280	0.54	145
FEBRUARY -2013	5.59	0.34	ND	275	0.57	142
MARCH -2013	NR	NR	NR	283	0.54	143
APRIL -2013	NR	NR	NR	276	0.52	151
MAY -2013	4.06	0.59	5.2	271	0.53	169
JUNE -2013	NR	NR	NR	253	0.53	175
JULY -2013	NR	NR	NR	243	0.53	180
AUGUST -2013	5.46	0.65	ND	245	0.54	183
SEPTEMBER-2013	NR	NR	NR	239	0.55	176
OCTOBER -2013	6.38	0.53	ND	220	0.56	182
NOVEMBER -2013	9.60	NR	ND	239	0.55	169
DECEMBER -2013	NR	NR	NR	236	0.55	172
=====	=====	=====	=====	=====	=====	=====
Annual Average:	6.22	0.53	1.0	255	0.54	166

ND= Not Detected  
NR= Not Required



SOUTH BAY WATER RECLAMATION PLANT  
SB\_REC\_WATER\_34 Reclaimed Water- Annual Averages

Annual 2013

Source:	Total Cyanides (surfactants)	MBAS	Percent Sodium Calculated %	Calcium	Magnesium	Potassium
MDL:	.002	.03		.04	.1	.3
Units:	MG/L	MG/L		MG/L	MG/L	MG/L
JANUARY -2013	NR	0.14	56.8	69.4	35.3	18.4
FEBRUARY -2013	0.002	0.11	57.1	68.6	35.0	18.2
MARCH -2013	NR	0.10	57.8	73.7	36.3	19.8
APRIL -2013	NR	0.07	58.7	70.2	33.7	18.8
MAY -2013	0.003	0.07	58.2	69.0	33.0	18.0
JUNE -2013	NR	0.08	57.3	72.1	33.4	20.5
JULY -2013	NR	0.06	55.4	70.8	29.7	17.0
AUGUST -2013	0.525	0.05	55.9	65.8	29.3	18.7
SEPTEMBER -2013	NR	0.13	56.3	66.5	30.9	16.1
OCTOBER -2013	0.003	0.11	57.2	67.6	27.7	17.5
NOVEMBER -2013	NR	0.13	57.2	64.7	27.9	16.0
DECEMBER -2013	NR	0.10	58.7	59.8	28.1	17.7
Annual Average:	0.133	0.10	57.2	68.2	31.7	18.1

Source:	Sodium	Calcium Hardness	Magnesium Hardness	Total Hardness	Total Dissolved Solids	Lithium
MDL:	1	.04	.1	.1	28	.002
Units:	MG/L	MG/L	MG/L	MG/L	MG/L	MG/L
JANUARY -2013	207	174	145	319	1000	0.03
FEBRUARY -2013	207	172	144	316	970	0.02
MARCH -2013	226	184	149	333	1000	0.03
APRIL -2013	221	176	138	314	1010	0.02
MAY -2013	212	173	135	308	1070	0.02
JUNE -2013	212	180	137	317	1090	0.03
JULY -2013	183	177	122	299	1060	0.04
AUGUST -2013	182	165	120	285	1090	0.03
SEPTEMBER -2013	186	166	127	293	960	0.03
OCTOBER -2013	187	169	114	283	925	0.03
NOVEMBER -2013	182	162	114	276	925	0.03
DECEMBER -2013	188	150	115	265	931	0.03
Annual Average:	199	170.7	130	301	1003	0.03

Source:	Cobalt	Molybdenum	Vanadium	Nitrate	Ortho Phosphat	Total Alkalinity (bicarbonate)
MDL:	.85	.89	.64	.04	.2	20
Units:	UG/L	UG/L	UG/L	MG/L	MG/L	MG/L
JANUARY -2013	NR	NR	NR	11.3	2.0	237
FEBRUARY -2013	ND	5.36	1.10	25.3	4.4	197
MARCH -2013	NR	NR	NR	17.7	4.2	189
APRIL -2013	NR	NR	NR	30.8	3.9	193
MAY -2013	ND	2.13	0.69	34.0	5.9	194
JUNE -2013	NR	NR	NR	21.9	7.1	190
JULY -2013	NR	NR	NR	18.3	4.1	229
AUGUST -2013	ND	5.21	ND	27.4	4.3	176
SEPTEMBER -2013	NR	NR	NR	26.7	4.6	184
OCTOBER -2013	ND	2.52	<0.64	27.2	4.2	165
NOVEMBER -2013	ND	3.20	0.95	29.8	6.9	182
DECEMBER -2013	NR	NR	NR	27.6	6.3	183
Annual Average:	ND	3.68	0.548	24.8	4.8	193

ND= Not Detected  
NR= Not Required

SOUTH BAY WATER RECLAMATION PLANT  
Reclaimed Water

Annual 2013

Source:		SB_REC_WATER_34	SB_REC_WATER_34	SB_REC_WATER_34	SB_REC_WATER_34
Date:		05-FEB-2013	07-MAY-2013	06-AUG-2013	01-OCT-2013
Sample ID:	MDL Units	P649759	P661225	P671234	P677772
Aluminum	47 UG/L	74	117	95	ND
Antimony	2.9 UG/L	ND	ND	ND	ND
Arsenic	.4 UG/L	0.6	0.8	0.8	0.7
Barium	.039 UG/L	45.2	60.4	59.2	59.1
Beryllium	.022 UG/L	ND	ND	ND	ND
Boron	7 UG/L	289	331	289	282
Cadmium	.53 UG/L	ND	ND	ND	ND
Chromium	1.2 UG/L	ND	ND	ND	2.2
Cobalt	.85 UG/L	ND	ND	ND	ND
Copper	2 UG/L	10	9	8	7
Iron	37 UG/L	64	85	49	53
Lead	2 UG/L	ND	ND	ND	ND
Manganese	.24 UG/L	22.9	8.5	34.8	6.9
Mercury	.005 UG/L	ND	ND	ND	ND
Molybdenum	.89 UG/L	5.4	2.1	5.2	2.5
Nickel	.53 UG/L	5.59	4.06	5.46	6.38
Selenium	.28 UG/L	0.34	0.59	0.65	0.53
Silver	.4 UG/L	ND	ND	ND	<0.4
Thallium	3.9 UG/L	ND	5.2	ND	ND
Vanadium	.64 UG/L	1.10	0.69	ND	<0.64
Zinc	2.5 UG/L	33.6	38.9	31.4	36.8
Bromide	.1 MG/L	0.5	0.4	0.3	0.2
Chloride	7 MG/L	276	282	238	223
Fluoride	.05 MG/L	0.55	0.54	0.58	0.49
Nitrate	.04 MG/L	25.8	36.2	24.8	37.4
Ortho Phosphate	.2 MG/L	4.5	3.1	6.0	7.9
Sulfate	9 MG/L	142	158	191	182
Calcium	.04 MG/L	69	69	66	68
Lithium	.002 MG/L	0.021	0.022	0.032	0.033
Magnesium	.1 MG/L	35	33	29	28
Potassium	.3 MG/L	18	18	19	18
Sodium	1 MG/L	207	212	182	187
Calcium Hardness	.1 MG/L	171	212	167	169
Magnesium Hardness	.4 MG/L	144	123	121	114
Total Hardness	.4 MG/L	315	319	288	283
Cyanide, Total	.002 MG/L	0.002	0.003	0.525	0.003
Sulfides-Total	.4 MG/L	ND	ND	ND	0.56
Total Kjeldahl Nitrogen	1.6 MG/L	5.3	ND	6.3	1.8
Ammonia-N	.3 MG/L	1.6	ND	ND	ND
Adjusted Sodium Adsorption	MG/L	5.7	5.9	5.2	5.2
Percent Sodium	PERCENT	57.1	58.2	55.9	57.2
Total Organic Carbon	MG/L	14.4	12.3	11.7	11.3

ND= Not Detected  
NR= Not Required

SOUTH BAY WATER RECLAMATION PLANT  
Radioactivity

Annual 2012

Source	Sample Date	Sample ID	Gross Alpha Radiation	Gross Beta Radiation
SB_REC_WATER_34	05-FEB-2013	P649759	2.1 ± 4.7	20.5 ± 5.7
SB_REC_WATER_34	07-MAY-2013	P661225	-5.9 ± 5.7	21.7 ± 8.1
SB_REC_WATER_34	06-AUG-2013	P671234	3.1 ± 5.6	15.0 ± 6.2
SB_REC_WATER_34	01-OCT-2013	P677772	1.9 ± 4.6	18.6 ± 5.4

Units in picocuries per Liter (pCi/L)

South Bay Water Reclamation Plant  
Chlorinated Pesticides

Reclaimed Water

Annual 2013

Date:			05-FEB-2013	07-MAY-2013	06-AUG-2013	01-OCT-2013
Analyte	MDL	Units	P649759	P661225	P671234*	P677772
Aldrin	8	NG/L	ND	ND	ND	ND
BHC, Alpha isomer	15	NG/L	ND	ND	ND	ND
BHC, Beta isomer	20	NG/L	ND	ND	ND	ND
BHC, Delta isomer	18	NG/L	ND	ND	ND	ND
BHC, Gamma isomer	15	NG/L	ND	ND	ND	ND
Alpha (cis) Chlordane	2	NG/L	ND	ND	ND	ND
Gamma (trans) Chlordane	2	NG/L	ND	ND	ND	ND
Alpha Chlordene		NG/L	NA	NA	NA	NA
Gamma Chlordene		NG/L	NA	NA	NA	NA
Cis Nonachlor	5	NG/L	ND	ND	NA	ND
Dieldrin	10	NG/L	ND	ND	ND	ND
Endosulfan Sulfate	15	NG/L	ND	ND	ND	ND
Alpha Endosulfan	15	NG/L	ND	ND	ND	ND
Beta Endosulfan	10	NG/L	ND	ND	ND	ND
Endrin	10	NG/L	ND	ND	ND	ND
Endrin aldehyde	10	NG/L	ND	ND	ND	ND
Heptachlor	15	NG/L	ND	ND	ND	ND
Heptachlor epoxide	13	NG/L	ND	ND	ND	ND
Methoxychlor	18	NG/L	ND	ND	ND	ND
Mirex	10	NG/L	ND	ND	ND	ND
o,p-DDD	100	NG/L	ND	ND	ND	ND
o,p-DDE	100	NG/L	ND	ND	ND	ND
o,p-DDT	100	NG/L	ND	ND	ND	ND
Oxychlordane	3	NG/L	ND	ND	NA	ND
PCB 1016	1300	NG/L	ND	ND	ND	ND
PCB 1221	1300	NG/L	ND	ND	ND	ND
PCB 1232	1300	NG/L	ND	ND	ND	ND
PCB 1242	1300	NG/L	ND	ND	ND	ND
PCB 1248	1300	NG/L	ND	ND	ND	ND
PCB 1254	1300	NG/L	ND	ND	ND	ND
PCB 1260	1300	NG/L	ND	ND	ND	ND
PCB 1262	1300	NG/L	ND	ND	ND	ND
p,p-DDD	20	NG/L	ND	ND	ND	ND
p,p-DDE	15	NG/L	ND	ND	ND	ND
p,p-DDT	20	NG/L	ND	ND	ND	ND
Toxaphene	1300	NG/L	ND	ND	ND	ND
Trans Nonachlor	3	NG/L	ND	ND	NA	ND
Heptachlors	15	NG/L	0	0	0	0
Endosulfans	15	NG/L	0	0	0	0
Polychlorinated biphenyls	1300	NG/L	0	0	0	0
Chlordane + related cmpds.	5	NG/L	0	0	0	0
DDT and derivatives	100	NG/L	0	0	0	0
Hexachlorocyclohexanes	20	NG/L	0	0	0	0
Aldrin + Dieldrin	10	NG/L	0	0	0	0
Chlorinated Hydrocarbons	1300	NG/L	0	0	0	0

\*= this sample was analyzed by TestAmerica Laboratories.

ND= Not Detected

Standards for alpha and gamma chlordene are no longer available in the U.S. for the analysis of these compounds.

South Bay Water Reclamation Plant  
Reclaimed Water

OrganoPhosphorous Analysis

Annual 2013

Date:		07-MAY-2013	01-OCT-2013
Analyte	MDL Units	P661225	P677772
Demeton O	.15 UG/L	ND	ND
Demeton S	.08 UG/L	ND	ND
Diazinon	.03 UG/L	ND	ND
Guthion	.15 UG/L	ND	ND
Malathion	.03 UG/L	ND	ND
Parathion	.03 UG/L	ND	ND
Dichlorvos	.05 UG/L	ND	ND
Disulfoton	.02 UG/L	ND	ND
Dimethoate	.04 UG/L	ND	ND
Stirophos	.03 UG/L	ND	ND
Coumaphos	.15 UG/L	ND	ND
Chlorpyrifos	.03 UG/L	ND	ND
Thiophosphorus Pesticides	.15 UG/L	0.0	0.0
Demeton -O, -S	.15 UG/L	0.0	0.0
Total Organophosphorus Pesticides	.15 UG/L	0.0	0.0

ND= Not Detected

South Bay Water Reclamation Plant  
Reclaimed Water

Organotins

Annual 2013

Source:		SB_REC_WATER_34	SB_REC_WATER_34	SB_REC_WATER_34	SB_REC_WATER_34
Date:		05-FEB-2013	07-MAY-2013	06-AUG-2013	01-OCT-2013
Analyte	MDL Units	P649759	P661225	P671234	P677772
=====	====	=====	=====	=====	=====
Tributyltin	2 UG/L	ND	ND	ND	ND
Dibutyltin	7 UG/L	ND	ND	ND	ND
Monobutyltin	16 UG/L	ND	ND	ND	ND

ND= Not Detected

South Bay Water Reclamation Plant  
Reclaimed Water

Phenols

Annual 2013

Date:		05-FEB-2013	07-MAY-2013	06-AUG-2013	01-OCT-2013
Analyte	MDL Units	P649759	P661225	P671234	P677772
2-Chlorophenol	1.32 UG/L	ND	ND	ND	ND
4-Chloro-3-methylphenol	1.67 UG/L	ND	ND	ND	ND
2,4-Dichlorophenol	1.01 UG/L	ND	ND	ND	ND
2,4-Dimethylphenol	2.01 UG/L	ND	ND	ND	ND
2,4-Dinitrophenol	2.16 UG/L	ND	ND	ND	ND
2-Methyl-4,6-dinitrophenol	1.52 UG/L	ND	ND	ND	ND
2-Nitrophenol	1.55 UG/L	ND	ND	ND	ND
4-Nitrophenol	1.14 UG/L	ND	ND	ND	ND
Pentachlorophenol	1.12 UG/L	ND	ND	ND	ND
Phenol	1.76 UG/L	ND	ND	ND	ND
2,4,6-Trichlorophenol	1.65 UG/L	ND	ND	ND	ND
Total Chlorinated Phenols	1.67 UG/L	0.0	0.0	0.0	0.0
Total Non-Chlorinated Phenols	2.16 UG/L	0.0	0.0	0.0	0.0
Total Phenols	2.16 UG/L	0.0	0.0	0.0	0.0

Additional analytes determined

2-Methylphenol	2.15 UG/L	ND	ND	ND	ND
3-Methylphenol(4-MP is unresolved)	UG/L	NA	NA	NA	NA
4-Methylphenol(3-MP is unresolved)	2.11 UG/L	ND	ND	ND	ND
2,4,5-Trichlorophenol	1.66 UG/L	ND	ND	ND	ND

ND= not detected

NA= not analyzed

South Bay Water Reclamation Plant  
Reclaimed water

Base/Neutrals

Annual 2013

Date:		05-FEB-2013	07-MAY-2013	06-AUG-2013	01-OCT-2013
Analyte	MDL Units	P649759	P661225	P671234	P677772
Acenaphthene	1.8 UG/L	ND	ND	ND	ND
Acenaphthylene	1.77 UG/L	ND	ND	ND	ND
Anthracene	1.29 UG/L	ND	ND	ND	ND
Benzidine	1.52 UG/L	ND	ND	ND	ND
Benzo[a]anthracene	1.1 UG/L	ND	ND	ND	ND
3,4-Benzo(b)fluoranthene	1.35 UG/L	ND	ND	ND	ND
Benzo[k]fluoranthene	1.49 UG/L	ND	ND	ND	ND
Benzo[a]pyrene	1.25 UG/L	ND	ND	ND	ND
Benzo[g,h,i]perylene	1.09 UG/L	ND	ND	ND	ND
4-Bromophenyl phenyl ether	1.4 UG/L	ND	ND	ND	ND
Bis-(2-chloroethoxy) methane	1.01 UG/L	ND	ND	ND	ND
Bis-(2-chloroethyl) ether	1.38 UG/L	ND	ND	ND	ND
Bis-(2-chloroisopropyl) ether	1.16 UG/L	ND	ND	ND	ND
4-Chlorophenyl phenyl ether	1.57 UG/L	ND	ND	ND	ND
2-Chloronaphthalene	1.87 UG/L	ND	ND	ND	ND
Chrysene	1.16 UG/L	ND	ND	ND	ND
Dibenzo(a,h)anthracene	1.01 UG/L	ND	ND	ND	ND
Butyl benzyl phthalate	2.84 UG/L	ND	ND	ND	ND
Di-n-butyl phthalate	3.96 UG/L	ND	ND	ND	ND
Bis-(2-ethylhexyl) phthalate	8.96 UG/L	ND	ND	21.4	ND
Diethyl phthalate	3.05 UG/L	ND	ND	ND	ND
Dimethyl phthalate	1.44 UG/L	ND	ND	ND	ND
Di-n-octyl phthalate	1 UG/L	ND	ND	ND	ND
3,3-Dichlorobenzidine	2.44 UG/L	ND	ND	ND	ND
2,4-Dinitrotoluene	1.36 UG/L	ND	ND	ND	ND
2,6-Dinitrotoluene	1.53 UG/L	ND	ND	ND	ND
1,2-Diphenylhydrazine	1.37 UG/L	ND	ND	ND	ND
Fluoranthene	1.33 UG/L	ND	ND	ND	ND
Fluorene	1.61 UG/L	ND	ND	ND	ND
Hexachlorobenzene	1.48 UG/L	ND	ND	ND	ND
Hexachlorobutadiene	1.64 UG/L	ND	ND	ND	ND
Hexachlorocyclopentadiene	1.25 UG/L	ND	ND	ND	ND
Hexachloroethane	1.32 UG/L	ND	ND	ND	ND
Indeno(1,2,3-CD)pyrene	1.14 UG/L	ND	ND	ND	ND
Isophorone	1.53 UG/L	ND	ND	ND	ND
Naphthalene	1.65 UG/L	ND	ND	ND	ND
Nitrobenzene	1.6 UG/L	ND	ND	ND	ND
N-nitrosodimethylamine	1.27 UG/L	ND	ND	ND	ND
N-nitrosodi-n-propylamine	1.16 UG/L	ND	ND	ND	ND
N-nitrosodiphenylamine	3.48 UG/L	ND	ND	ND	ND
Phenanthrene	1.34 UG/L	ND	ND	ND	ND
Pyrene	1.43 UG/L	ND	ND	ND	ND
1,2,4-Trichlorobenzene	1.52 UG/L	ND	ND	ND	ND
Polynuc. Aromatic Hydrocarbons	1.77 UG/L	0.0	0.0	0.0	0.0
Base/Neutral Compounds	8.96 UG/L	0.0	0.0	21.4	0.0

Additional analytes determined

Benzo[e]pyrene	1.44 UG/L	ND	ND	ND	ND
Biphenyl	2.29 UG/L	ND	ND	ND	ND
2,6-Dimethylnaphthalene	2.16 UG/L	ND	ND	ND	ND
1-Methylnaphthalene	2.18 UG/L	ND	ND	ND	ND
1-Methylphenanthrene	1.46 UG/L	ND	ND	ND	ND
2-Methylnaphthalene	2.14 UG/L	ND	ND	ND	ND
2,3,5-Trimethylnaphthalene	2.18 UG/L	ND	ND	ND	ND
Perylene	1.41 UG/L	ND	ND	ND	ND

ND= Not Detected



SOUTH BAY WASTEWATER TREATMENT PLANT  
Annual Priority Pollutants Purgeable Compounds, EPA Method 624 Report

Annual 2013

Source:		SB_REC_WATER_34	SB_REC_WATER_34	SB_REC_WATER_34	SB_REC_WATER_34
Date:		05-FEB-2013	07-MAY-2013	06-AUG-2013	01-OCT-2013
Analyte	MDL Units	P649762	P661228	P671237	P677775
Dichlorodifluoromethane	.66 UG/L	ND	ND	ND	ND
Chloromethane	.5 UG/L	ND	ND	ND	ND
Vinyl chloride	.4 UG/L	ND	ND	ND	ND
Bromomethane	.7 UG/L	ND	ND	ND	ND
Chloroethane	.9 UG/L	ND	ND	ND	ND
Trichlorofluoromethane	.3 UG/L	ND	ND	ND	ND
Acrolein	1.3 UG/L	ND	ND	ND	ND
1,1-Dichloroethane	.4 UG/L	ND	ND	ND	ND
Methylene chloride	.3 UG/L	ND	ND	DNQ0.4	DNQ0.4
trans-1,2-dichloroethene	.6 UG/L	ND	ND	ND	ND
1,1-Dichloroethene	.4 UG/L	ND	ND	ND	ND
Acrylonitrile	.7 UG/L	ND	ND	ND	ND
Chloroform	.2 UG/L	DNQ0.5	25.3	DNQ0.4	14.0
1,1,1-Trichloroethane	.4 UG/L	ND	ND	ND	ND
Carbon tetrachloride	.4 UG/L	ND	ND	ND	ND
Benzene	.4 UG/L	ND	ND	ND	ND
1,2-Dichloroethane	.5 UG/L	ND	ND	ND	ND
Trichloroethene	.7 UG/L	ND	ND	ND	ND
1,2-Dichloropropane	.3 UG/L	ND	ND	ND	ND
Bromodichloromethane	.5 UG/L	ND	33.9	ND	9.6
2-Chloroethylvinyl ether	1.1 UG/L	ND	ND	ND	ND
cis-1,3-dichloropropene	.3 UG/L	ND	ND	ND	ND
Toluene	.4 UG/L	ND	ND	ND	ND
trans-1,3-dichloropropene	.5 UG/L	ND	ND	ND	ND
1,1,2-Trichloroethane	.5 UG/L	ND	ND	ND	ND
Tetrachloroethene	1.1 UG/L	ND	ND	ND	ND
Dibromochloromethane	.6 UG/L	ND	20.2	ND	4.1
Chlorobenzene	.4 UG/L	ND	ND	ND	ND
Ethylbenzene	.3 UG/L	ND	ND	ND	ND
Bromoform	.5 UG/L	ND	3.0	ND	ND
1,1,2,2-Tetrachloroethane	.5 UG/L	ND	ND	ND	ND
1,3-Dichlorobenzene	.5 UG/L	ND	ND	ND	ND
1,4-Dichlorobenzene	.4 UG/L	ND	ND	ND	ND
1,2-Dichlorobenzene	.4 UG/L	ND	ND	ND	ND
1,2,4-Trichlorobenzene	.7 UG/L	ND	ND	ND	ND
Halomethane Purgeable Cmpnds	.7 UG/L	0.0	3.0	0.0	0.0
Total Dichlorobenzenes	.5 UG/L	0.0	0.0	0.0	0.0
Total Chloromethanes	.5 UG/L	0.0	25.3	0.0	14.0
Purgeable Compounds	1.3 UG/L	0.0	82.4	0.0	27.7

Additional analytes determined

Methyl Iodide	.6 UG/L	ND	ND	ND	ND
Carbon disulfide	.6 UG/L	ND	ND	ND	ND
Acetone	4.5 UG/L	ND	DNQ6.1	ND	ND
Allyl chloride	.6 UG/L	ND	ND	ND	ND
Methyl tert-butyl ether	.4 UG/L	ND	ND	ND	ND
Chloroprene	.4 UG/L	ND	ND	ND	ND
1,2-Dibromoethane	.3 UG/L	ND	ND	ND	ND
2-Butanone	6.3 UG/L	ND	ND	ND	ND
Methyl methacrylate	.8 UG/L	ND	ND	ND	ND
2-Nitropropane	12 UG/L	ND	ND	ND	ND
4-Methyl-2-pentanone	1.3 UG/L	ND	ND	ND	ND
meta,para xylenes	.6 UG/L	ND	ND	ND	ND
ortho-xylene	.4 UG/L	ND	ND	ND	ND
Isopropylbenzene	.3 UG/L	ND	ND	ND	ND
Styrene	.3 UG/L	ND	ND	ND	ND
Benzyl chloride	1.1 UG/L	ND	ND	ND	ND

ND= not detected

DNQ= (Detected but not quantified). Estimated analyte concentration below calibration range.

South Bay Water Reclamation Plant  
Reclaimed Water

Benzidines

Annual 2013

Source:		SB_REC_WATER_34	SB_REC_WATER_34	SB_REC_WATER_34	SB_REC_WATER_34	
Date:		05-FEB-2013	07-MAY-2013	06-AUG-2013	01-OCT-2013	
Analyte	MDL	Units	P649759	P661225	P671234	P677772
=====	====	====	=====	=====	=====	=====
3,3-Dichlorobenzidine	2.44	UG/L	ND	ND	ND	ND
Benzidine	1.52	UG/L	ND	ND	ND	ND

ND= Not Detected

## B. Reclaimed Water Graphs

Graphs of monthly averages for permit parameters with measurable concentration averages.

Please note that many of the graphs are on expanded scales. That is, they normally don't go to zero concentrations but show, in magnified scale, that range of concentrations where variation takes place. This makes differences and some trends obvious that might normally not be noticed. However, it also provides the temptation to interpret minor changes or trends as being of more significance than they are. Frequent reference to the scales and the actual differences in concentrations is therefore necessary.

## 2013 South Bay Reclaimed Water Biological Oxygen Demand

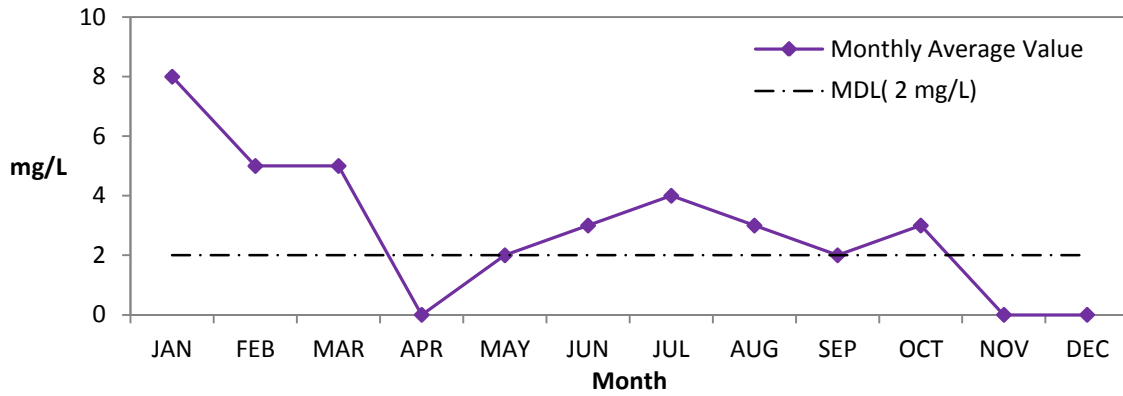

## Total Suspended Solids

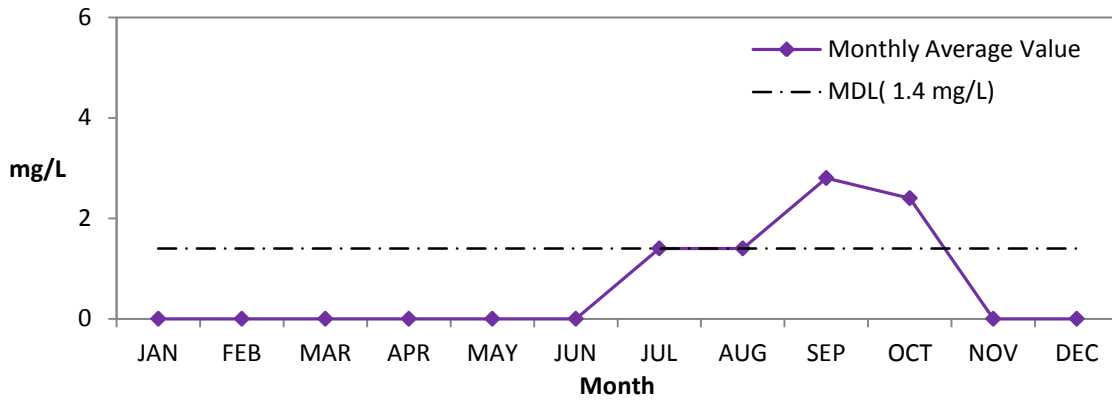

## Total Dissolved Solids

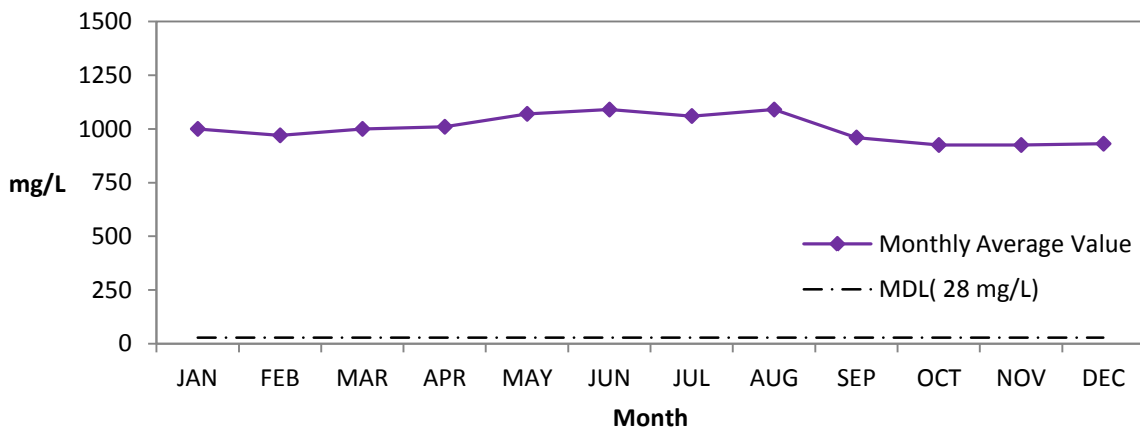

## 2013 South Bay Reclaimed Water

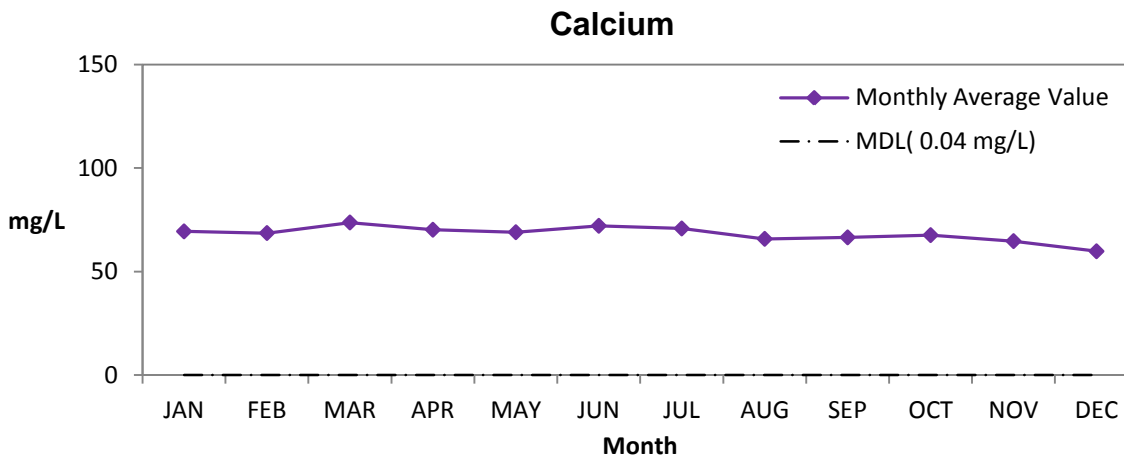
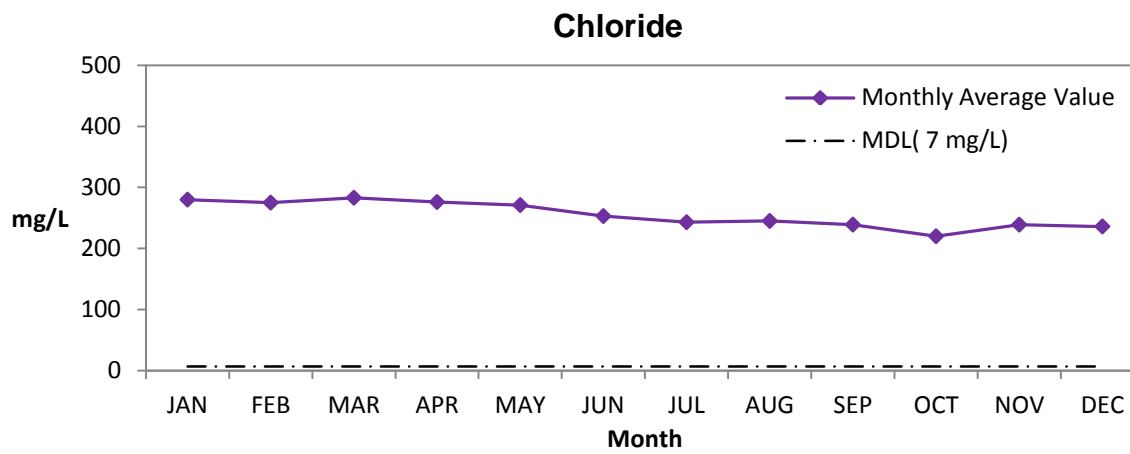
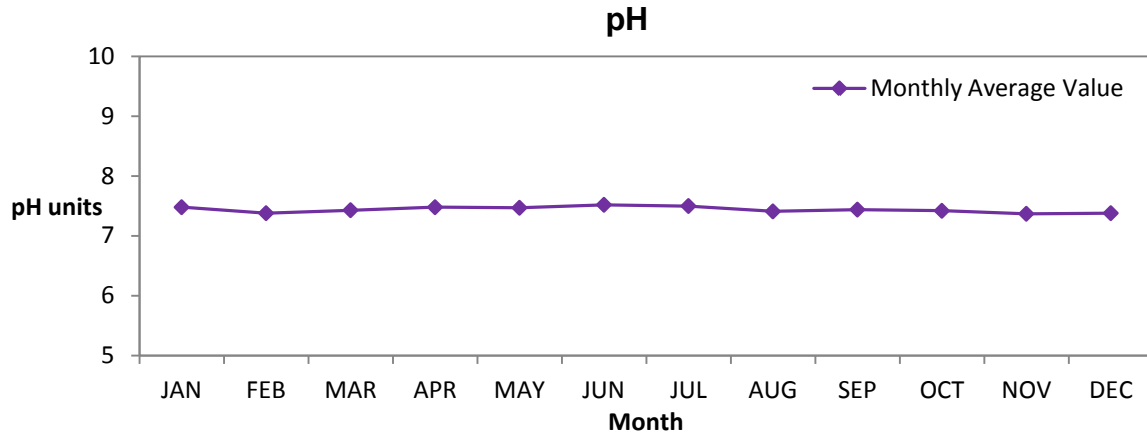

# 2013 South Bay Reclaimed Water

## Magnesium

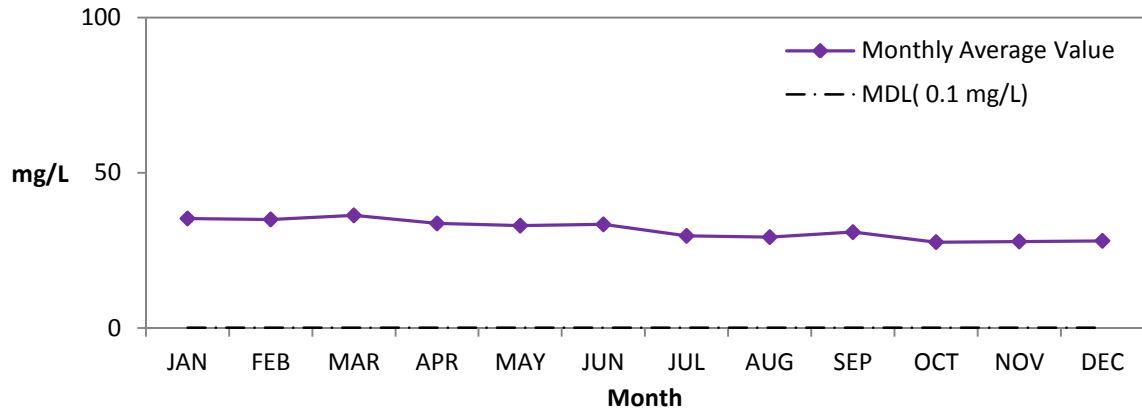

## Sulfate

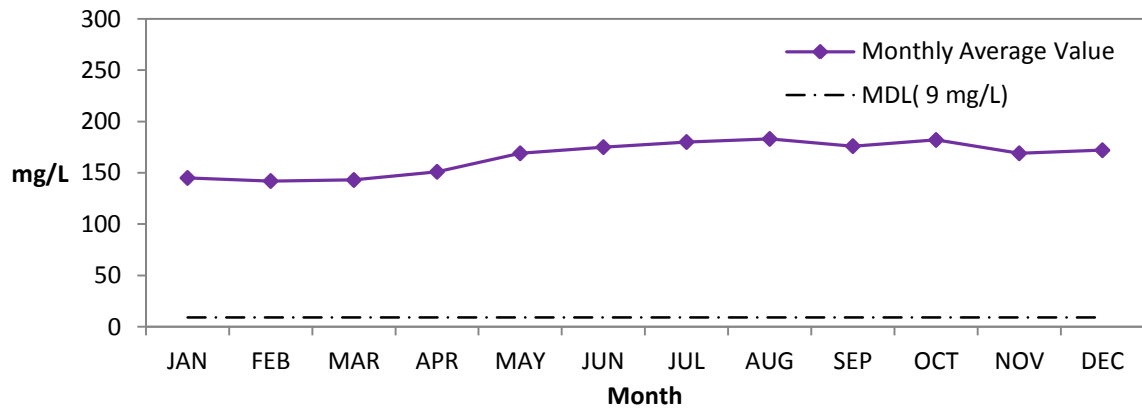

## Fluoride

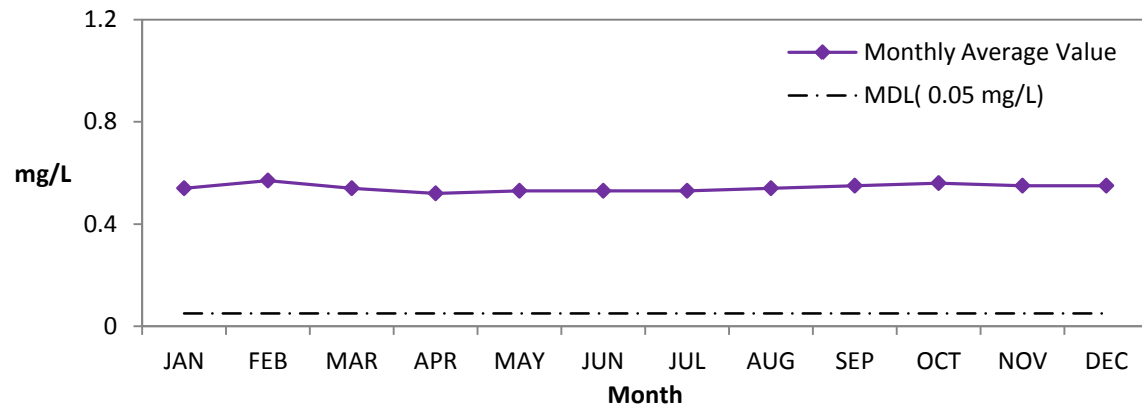

## 2013 South Bay Reclaimed Water

### Total Hardness

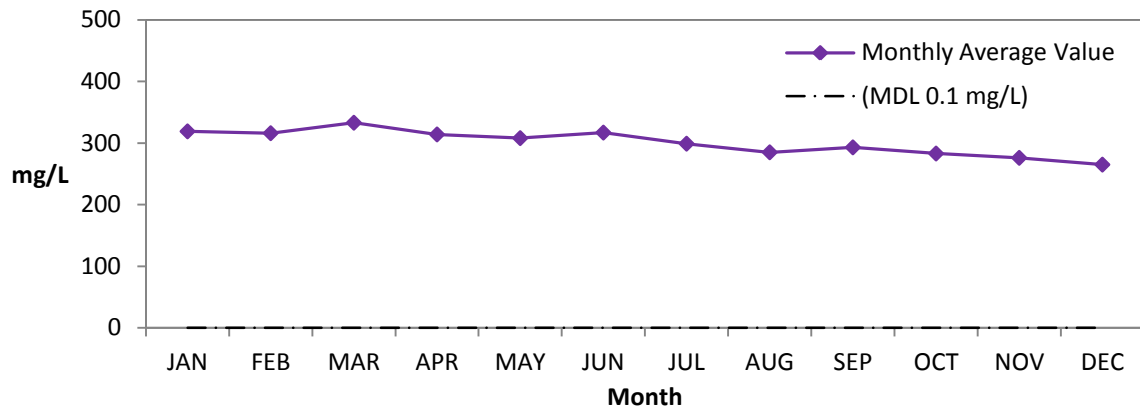

### Manganese

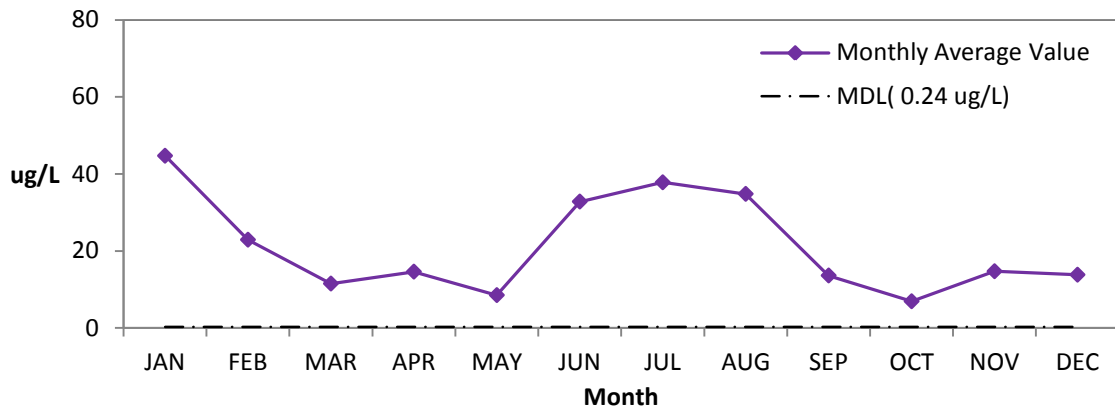

### Iron

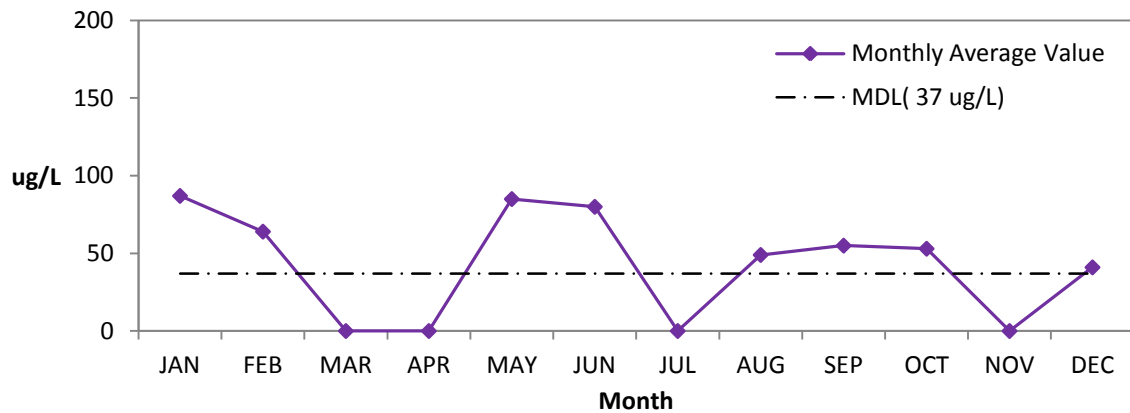

## 2013 South Bay Reclaimed Water

### Boron

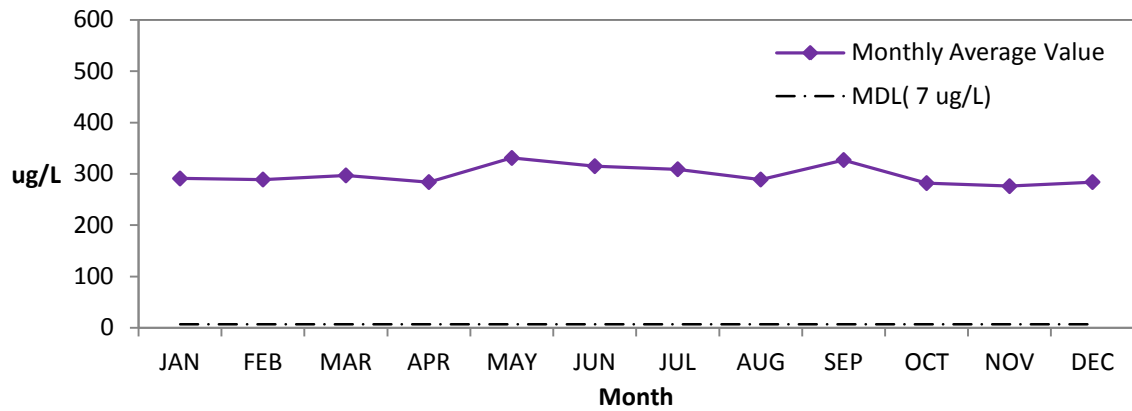

### MBAS

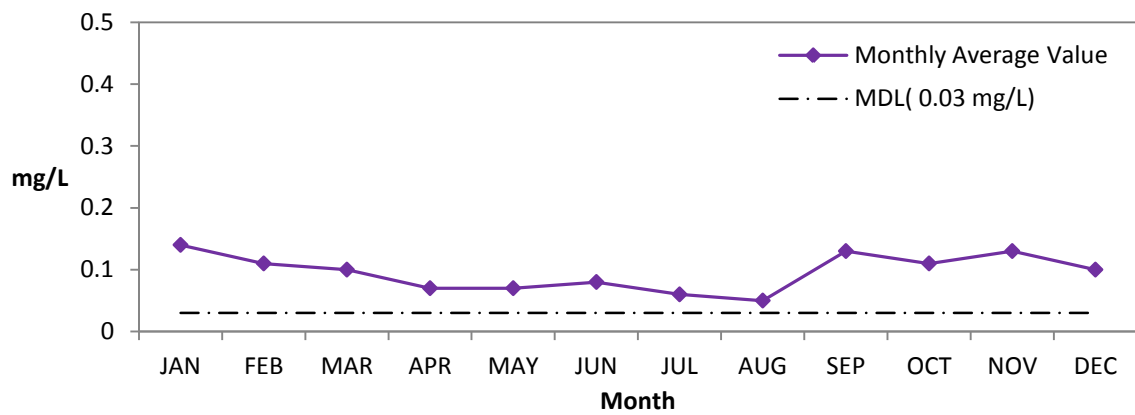

### Percent Sodium

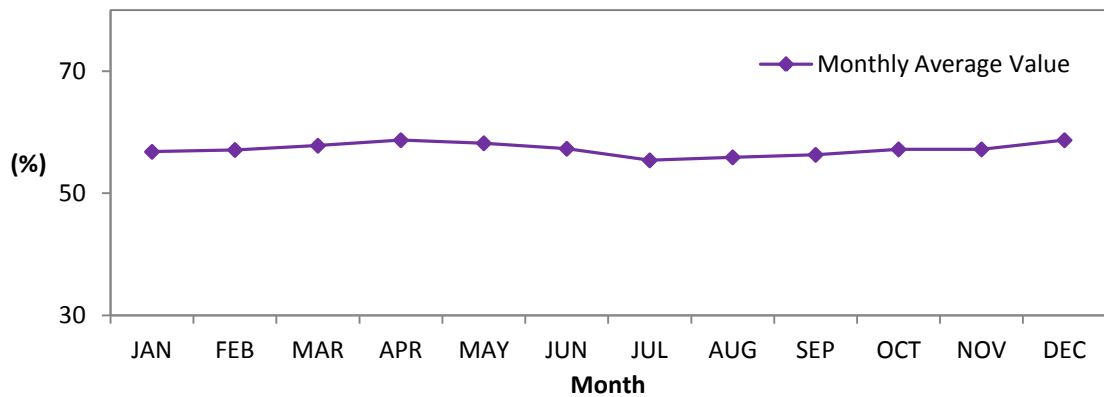



This page is left blank intentionally.

C. Daily Values of Selected Parameters.

Daily values of selected parameters (e.g. TSS, Flow, BOD, etc.) are tabulated and presented graphically; statistical summary information is provided.

### South Bay Wastewater Reclamation Plant 2013 Reclaimed Production Flows

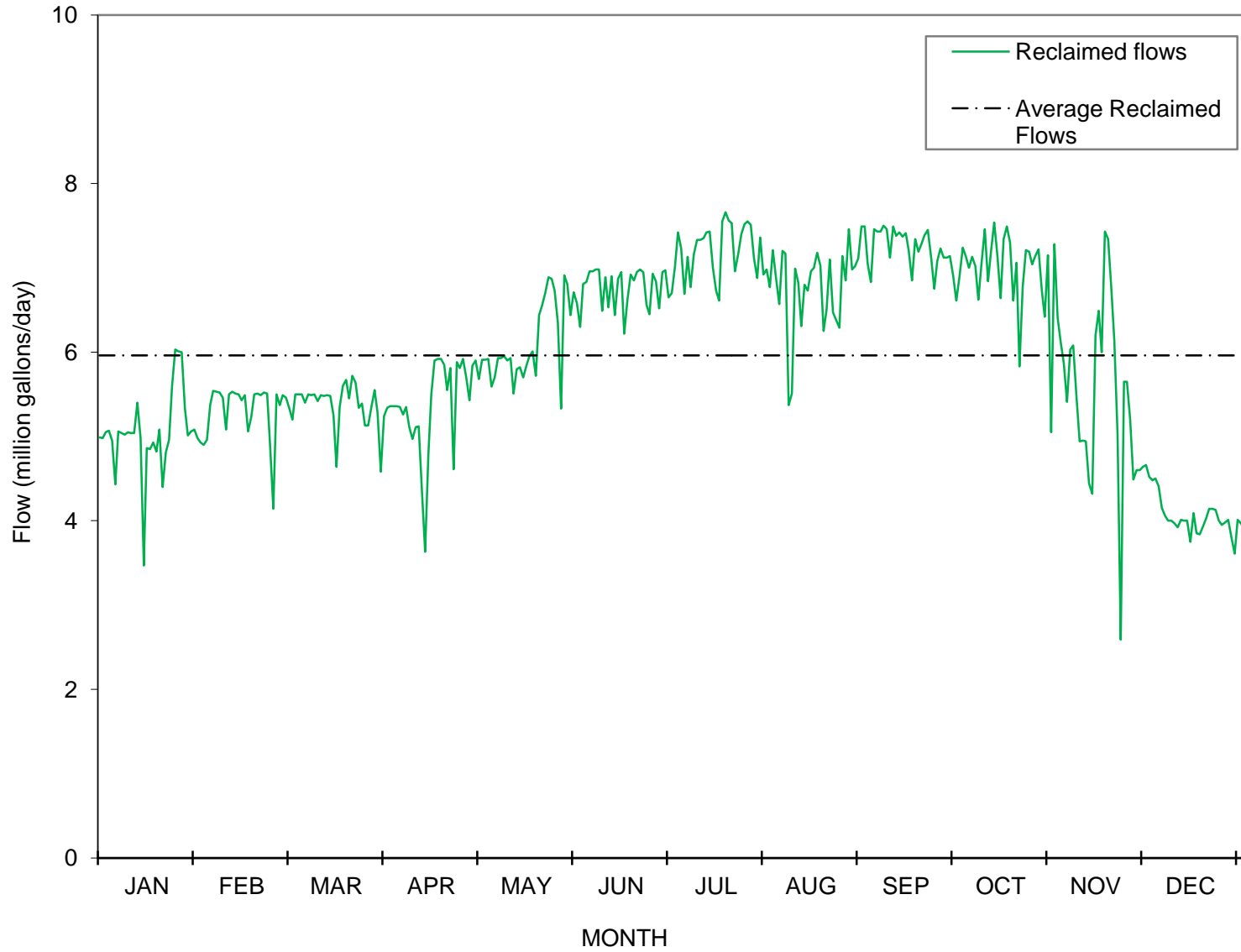

## Daily Flows - Reclaimed Water Produced in 2013

Days	Jan	Feb	Mar	Apr	May	Jun	Jul	Aug	Sep	Oct	Nov	Dec	
1	4.99	4.98	5.46	5.24	5.68	6.58	6.70	6.77	7.05	7.24	6.13	4.50	
2	4.98	4.93	5.34	5.34	5.91	6.30	7.02	7.21	6.83	7.14	5.87	4.41	
3	5.05	4.90	5.20	5.36	5.91	6.81	7.42	6.88	7.46	7.00	5.41	4.15	
4	5.07	4.96	5.50	5.36	5.92	6.83	7.23	6.57	7.43	7.13	6.03	4.06	
5	4.95	5.37	5.50	5.36	5.59	6.96	6.69	7.20	7.43	7.02	6.08	4.00	
6	4.43	5.54	5.50	5.35	5.70	6.96	7.13	7.17	7.50	6.62	5.48	4.00	
7	5.06	5.53	5.40	5.26	5.93	6.98	6.77	5.37	7.46	7.06	4.94	3.97	
8	5.04	5.52	5.50	5.35	5.93	6.98	7.16	5.51	7.12	7.46	4.95	3.92	
9	5.02	5.46	5.49	5.11	5.95	6.49	7.33	6.99	7.49	6.84	4.94	4.01	
10	5.05	5.08	5.50	4.97	5.90	6.89	7.33	6.82	7.38	7.19	4.44	4.00	
11	5.04	5.50	5.42	5.11	5.93	6.53	7.35	6.31	7.42	7.54	4.32	4.00	
12	5.04	5.53	5.49	5.12	5.51	6.90	7.42	6.80	7.37	7.14	6.20	3.75	
13	5.40	5.51	5.48	4.36	5.80	6.44	7.43	6.73	7.41	6.64	6.49	4.09	
14	4.98	5.50	5.49	3.63	5.82	6.87	7.00	6.96	7.20	7.34	6.00	3.85	
15	3.47	5.43	5.48	4.78	5.70	6.95	6.73	7.00	6.85	7.49	7.43	3.84	
16	4.86	5.49	5.25	5.50	5.84	6.22	6.61	7.18	7.34	7.30	7.34	3.93	
17	4.85	5.06	4.64	5.90	5.95	6.62	7.55	7.03	7.19	6.61	6.75	4.03	
18	4.93	5.23	5.35	5.92	6.01	6.92	7.66	6.25	7.29	7.06	6.14	4.14	
19	4.82	5.50	5.60	5.92	5.72	6.85	7.56	6.50	7.39	5.83	5.03	4.14	
20	5.08	5.51	5.67	5.85	6.44	6.95	7.53	7.10	7.45	6.77	2.59	4.13	
21	4.40	5.49	5.45	5.55	6.55	6.98	6.96	6.47	7.13	7.21	5.65	4.00	
22	4.81	5.52	5.72	5.81	6.70	6.95	7.16	6.38	6.75	7.19	5.65	3.95	
23	4.96	5.51	5.64	4.61	6.89	6.56	7.40	6.29	7.08	7.04	5.20	3.98	
24	5.59	4.89	5.34	5.88	6.87	6.45	7.52	7.14	7.23	7.14	4.49	4.01	
25	6.03	4.14	5.39	5.81	6.73	6.93	7.55	6.85	7.12	7.22	4.60	3.80	
26	6.01	5.50	5.13	5.92	6.35	6.84	7.51	7.46	7.12	6.74	4.60	3.61	
27	6.00	5.37	5.13	5.70	5.33	6.52	7.11	6.98	7.14	6.42	4.64	4.01	
28	5.33	5.49	5.35	5.43	6.91	6.95	6.88	7.02	6.91	7.15	4.66	3.97	
29	5.01		5.55	5.84	6.81	6.97	7.36	7.11	6.61	5.05	4.52	3.91	
30	5.06		5.28	5.90	6.44	6.65	6.92	7.49	6.90	7.28	4.48	3.91	
31	5.08		4.58		6.71		6.98	7.49		6.41		3.99	
<b>Average</b>	5.04	5.30	5.38	5.37	6.11	6.76	7.19	6.81	7.20	6.94	5.37	4.00	5.96
<b>Minimum</b>	3.47	4.14	4.58	3.63	5.33	6.22	6.61	5.37	6.61	5.05	2.59	3.61	2.59
<b>Maximum</b>	6.03	5.54	5.72	5.92	6.91	6.98	7.66	7.49	7.50	7.54	7.43	4.50	7.66
<b>Total</b>	156	148	167	161	189	203	223	211	216	215	161	124	2176

### Daily Flows - Reclaimed Water Distributed in 2013

Days	Jan	Feb	Mar	Apr	May	Jun	Jul	Aug	Sep	Oct	Nov	Dec	
1	0.00	0.00	2.48	3.27	4.39	5.59	5.84	5.90	2.83	5.48	0.00	0.00	
2	0.00	0.00	0.00	2.60	5.01	4.60	5.71	6.11	4.57	5.80	0.00	0.00	
3	0.00	0.00	0.00	3.46	5.17	5.75	6.39	6.03	6.71	6.06	0.00	0.00	
4	0.00	0.00	2.03	2.56	3.30	5.72	6.23	4.70	6.46	6.15	3.70	1.68	
5	0.00	1.58	3.81	2.53	0.31	6.03	5.74	4.16	6.44	6.07	4.71	0.00	
6	0.00	3.92	2.87	1.47	2.93	6.01	5.22	4.88	6.41	5.01	4.04	2.53	
7	0.00	1.79	2.21	0.01	0.77	6.13	0.27	4.38	6.69	4.93	4.19	3.24	
8	0.00	0.00	0.80	4.36	1.18	5.70	6.23	4.43	3.83	6.18	4.05	2.61	
9	0.00	0.00	0.00	3.85	2.64	0.00	6.16	5.57	4.53	4.43	4.26	0.00	
10	0.00	0.00	0.00	1.04	3.15	4.80	6.10	5.63	5.86	1.92	0.95	0.00	
11	0.00	0.00	0.00	1.41	2.54	5.74	6.45	5.26	6.42	2.00	1.73	0.00	
12	0.00	0.00	1.20	1.33	3.05	5.91	6.38	5.53	6.35	1.83	4.61	0.00	
13	0.00	0.00	0.00	0.81	4.45	4.64	4.53	5.72	6.49	0.00	4.18	0.00	
14	0.00	0.00	0.00	0.00	4.34	6.04	0.64	6.05	6.22	3.24	3.71	0.00	
15	0.00	0.00	0.00	3.28	2.28	6.06	5.83	6.17	3.11	4.78	5.61	0.00	
16	0.00	2.69	0.00	4.85	1.09	3.30	5.35	6.32	3.56	5.50	3.56	2.74	
17	0.00	2.14	0.00	5.07	3.91	4.12	6.52	6.16	5.58	5.06	0.00	3.01	
18	0.00	0.43	2.85	5.17	4.56	5.98	0.00	5.29	6.08	5.32	3.86	3.28	
19	0.00	1.21	4.44	4.21	4.71	5.81	3.31	4.92	6.29	4.52	0.00	3.06	
20	0.00	0.00	1.61	5.13	4.99	6.02	5.74	5.76	6.35	4.26	0.00	2.80	
21	0.00	0.00	0.00	2.24	5.07	6.00	5.72	5.51	6.40	4.01	3.65	0.00	
22	0.00	0.00	2.59	4.50	5.48	6.12	6.16	5.50	5.47	4.87	2.29	0.00	
23	2.55	0.00	4.63	2.07	6.05	3.77	6.34	5.39	4.90	1.89	0.00	0.00	
24	3.87	0.00	0.86	4.43	6.05	4.37	5.01	6.27	6.25	1.90	0.00	0.00	
25	3.95	0.00	2.28	1.20	5.96	5.88	6.56	6.04	6.19	5.67	0.00	0.00	
26	3.81	0.00	0.00	1.94	0.99	5.87	6.56	5.65	6.34	6.00	0.00	0.00	
27	0.00	2.54	2.69	4.89	2.59	4.91	6.08	5.43	6.22	3.62	0.00	1.98	
28	0.00	3.89	4.61	3.68	5.47	5.90	5.82	6.31	5.48	3.36	0.00	2.98	
29	0.00		3.58	5.08	5.41	6.24	5.22	6.27	3.04	0.00	0.00	2.82	
30	0.00		0.38	5.12	5.46	5.80	3.54	6.53	4.15	2.72	0.00	2.97	
31	0.00		1.70		5.81		5.27	6.67		0.00		2.67	Annual Summary
<b>Average</b>	0.46	0.72	1.54	3.05	3.84	5.29	5.19	5.63	5.51	3.95	1.97	1.24	3.20
<b>Minimum</b>	0.00	0.00	0.00	0.00	0.31	0.00	0.00	4.16	2.83	0.00	0.00	0.00	0.00
<b>Maximum</b>	3.95	3.92	4.63	5.17	6.05	6.24	6.56	6.67	6.71	6.18	5.61	3.28	6.71
<b>Total</b>	14.2	20.2	47.6	91.6	119.1	158.8	160.9	174.5	165.2	122.6	59.1	38.4	1172

### South Bay Wastewater Reclamation Plant 2013 Reclaimed Water Distributed Flows

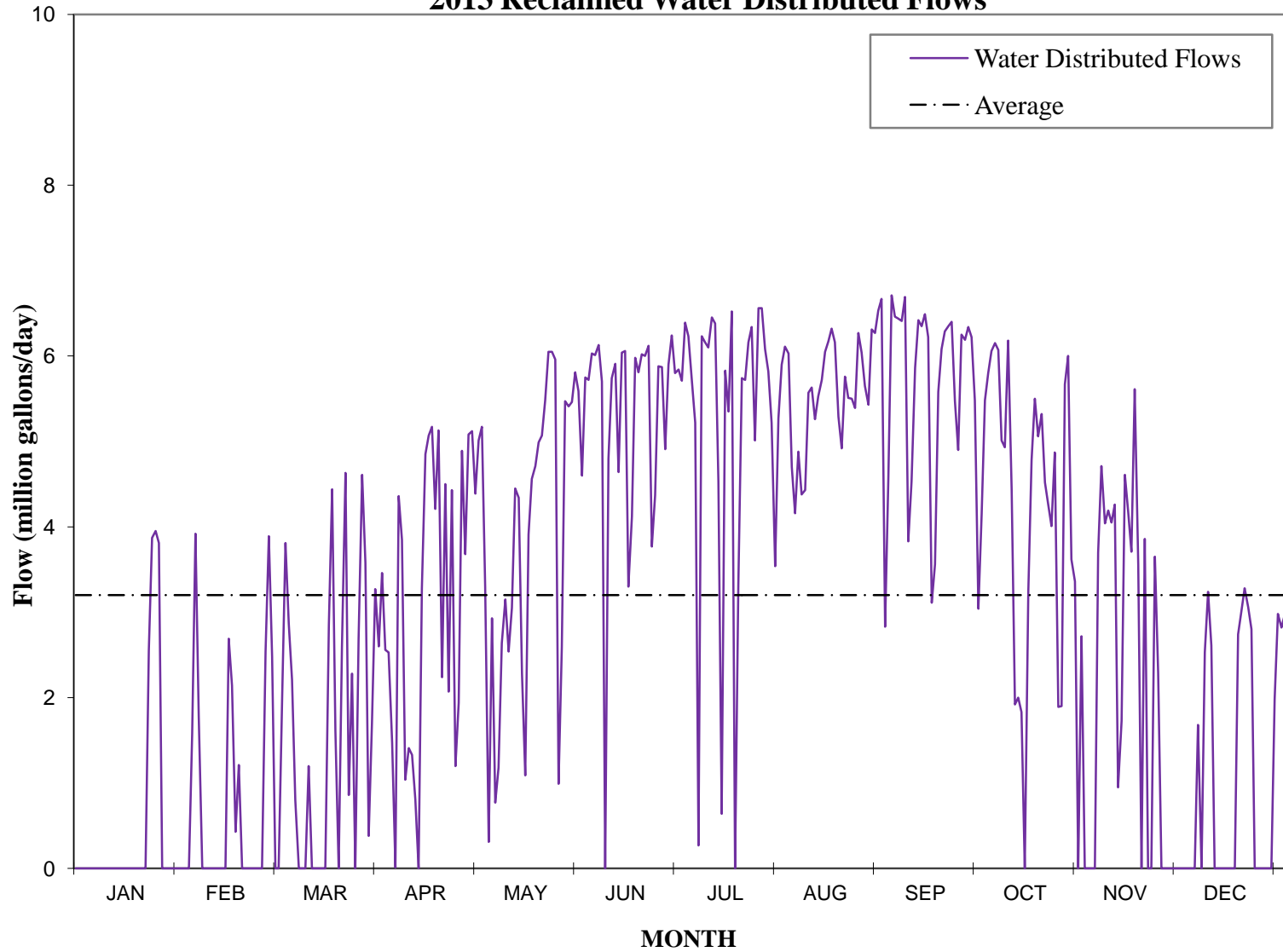

## South Bay Wastewater Reclamation Plant 2013 Reclaimed Water Produced and Distributed Flows

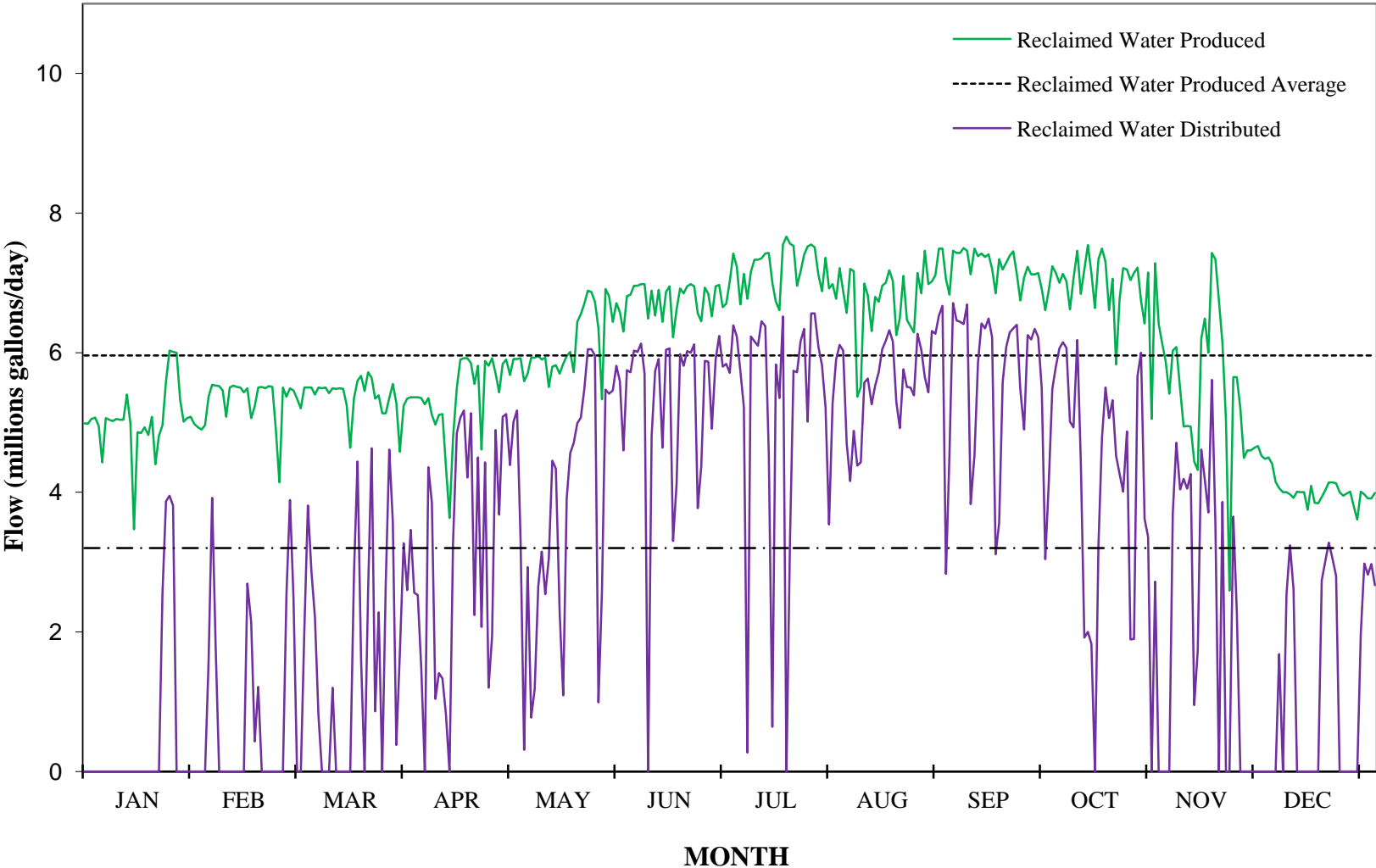

This page left blank intentionally.



## South Bay Wastewater Reclamation Plant 2013 Total Suspended Solids

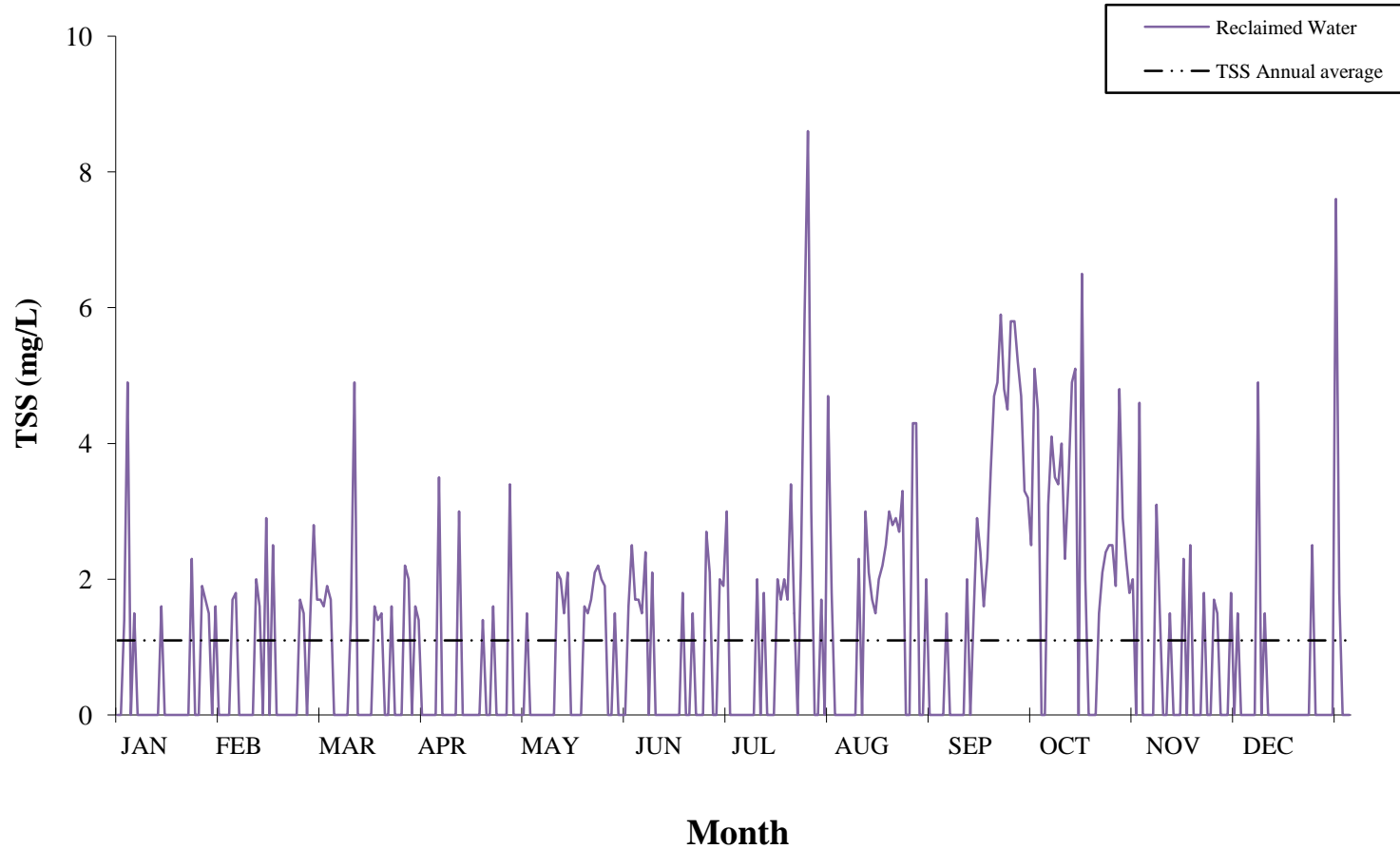

### Daily Reclaimed Water TSS Values in 2013

Day	Jan	Feb	Mar	Apr	May	Jun	Jul	Aug	Sep	Oct	Nov	Dec	
1	ND	ND	1.7	ND	ND	1.6	ND	ND	ND	ND	ND	ND	
2	ND	ND	1.7	ND	1.5	2.5	ND	ND	ND	ND	ND	ND	
3	1.4	ND	1.6	ND	ND	1.7	ND	ND	1.5	3.1	ND	ND	
4	4.9	1.7	1.9	ND	ND	1.7	ND	ND	ND	4.1	3.1	4.9	
5	ND	1.8	1.7	ND	ND	1.5	ND	ND	ND	3.5	1.5	ND	
6	1.5	ND	ND	3.5	ND	2.4	ND	ND	ND	3.4	ND	1.5	
7	ND	ND	ND	ND	ND	ND	ND	ND	ND	4.0	ND	ND	
8	ND	ND	ND	ND	ND	2.1	ND	2.3	ND	2.3	1.5	ND	
9	ND	ND	ND	ND	ND	ND	2.0	ND	2.0	3.5	ND	ND	
10	ND	ND	ND	ND	ND	ND	ND	3.0	ND	4.9	ND	ND	
11	ND	2.0	1.4	ND	2.1	ND	1.8	2.1	1.5	5.1	ND	ND	
12	ND	1.6	4.9	3.0	2.0	ND	ND	1.7	2.9	ND	2.3	ND	
13	ND	ND	ND	ND	1.5	ND	ND	1.5	2.4	6.5	ND	ND	
14	1.6	2.9	ND	ND	2.1	ND	ND	2.0	1.6	2.0	2.5	ND	
15	ND	ND	ND	ND	ND	ND	2.0	2.2	2.3	ND	ND	ND	
16	ND	2.5	ND	ND	ND	ND	1.7	2.5	3.6	ND	ND	ND	
17	ND	ND	ND	ND	ND	1.8	2.0	3.0	4.7	ND	ND	ND	
18	ND	ND	1.6	ND	ND	ND	1.7	2.8	4.9	1.5	1.8	ND	
19	ND	ND	1.4	1.4	1.6	ND	3.4	2.9	5.9	2.1	ND	ND	
20	ND	ND	1.5	ND	1.5	1.5	1.5	2.7	4.8	2.4	ND	2.5	
21	ND	ND	ND	ND	1.7	ND	ND	3.3	4.5	2.5	1.7	ND	
22	ND	ND	ND	1.6	2.1	ND	2.2	ND	5.8	2.5	1.5	ND	
23	2.3	ND	1.6	ND	2.2	ND	5.9	ND	5.8	1.9	ND	ND	
24	ND	1.7	ND	ND	2.0	2.7	8.6	4.3	5.2	4.8	ND	ND	
25	ND	1.5	ND	ND	1.9	2.1	3.0	4.3	4.7	2.9	ND	ND	
26	1.9	ND	ND	ND	ND	ND	ND	ND	3.3	2.3	1.8	ND	
27	1.7	1.5	2.2	3.4	ND	ND	ND	ND	3.2	1.8	ND	7.6	
28	1.5	2.8	2.0	ND	1.5	2.0	1.7	2.0	2.5	2.0	1.5	1.8	
29	ND		ND	ND	ND	1.9	ND	ND	5.1	ND	ND	ND	
30	1.6		1.6	ND	ND	3.0	4.7	ND	4.5	4.6	ND	ND	
31	ND		1.4		ND		1.8	ND		ND		ND	
<b>Ave</b>	0.6	0.7	0.9	0.4	0.8	1.0	1.4	1.4	2.8	2.4	0.6	0.6	Annual Summary
<b>Min</b>	ND	ND	ND	ND	ND	ND	ND	ND	ND	ND	ND	ND	1.1
<b>Max</b>	4.9	2.9	4.9	3.5	2.2	3.0	8.6	4.3	5.9	6.5	3.1	7.6	8.6

**South Bay Wastewater Reclamation Plant  
2013 Biochemical Oxygen Demand**

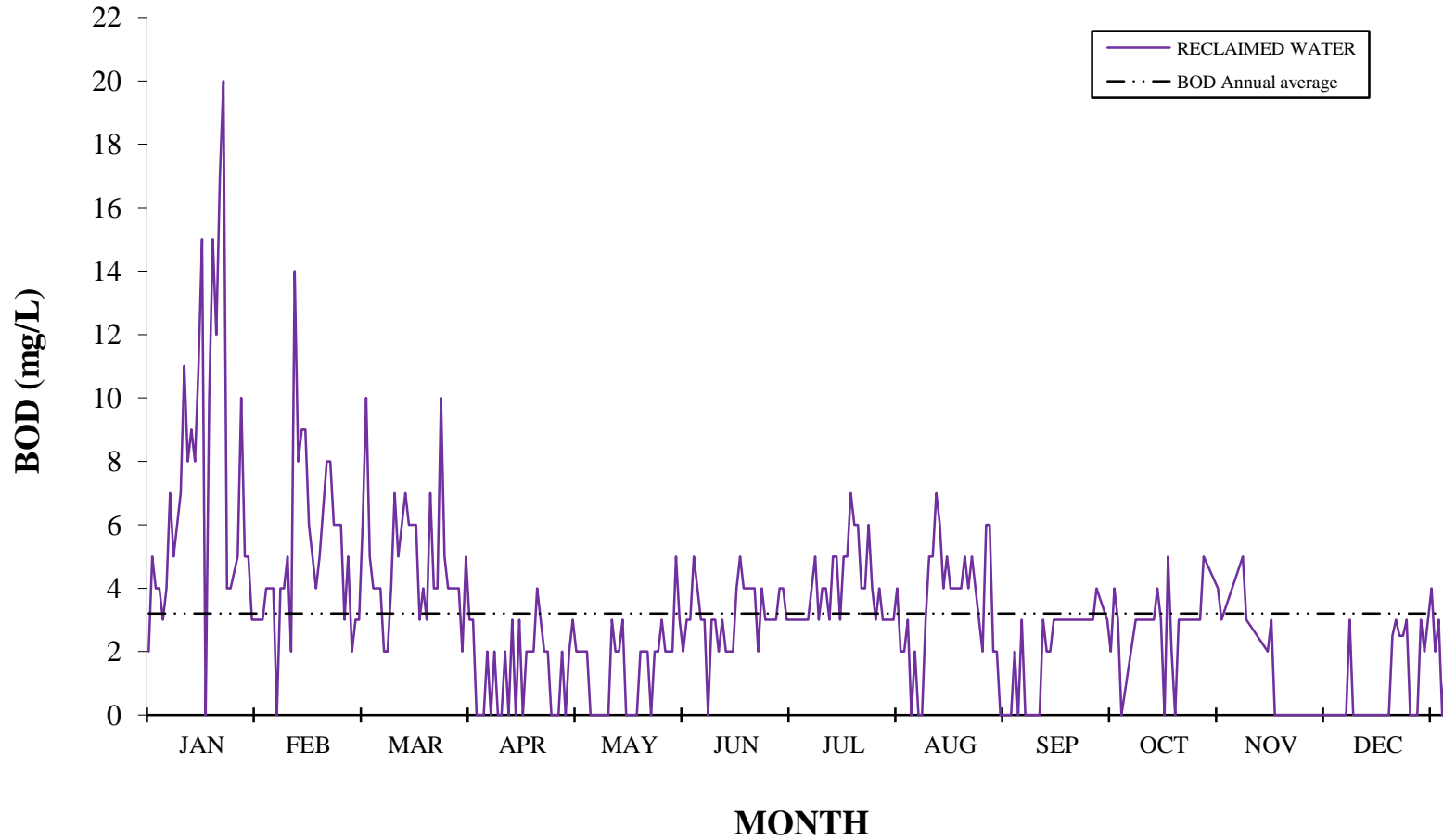

### Daily Reclaimed Water BOD Values 2013

Day	Jan	Feb	Mar	Apr	May	Jun	Jul	Aug	Sep	Oct	Nov	Dec	
1	2	3	3	3	2	3	3	2	2	ND		ND	
2	5	3	6	3	2	3	3	3	ND			ND	
3	4	4	10	ND	2	5		ND	3			ND	
4	4	4	5	ND	2	4		2	ND		5	3	
5	3	4	4	ND	ND	3	3	ND	ND	3	3	ND	
6	4	ND	4	2	ND	3	4	ND	ND	3			
7	7	4	4	ND	ND	ND	5	3	ND			ND	
8	5	4	2	2	ND	3	3	5	ND			ND	
9	6	5	2	ND	ND	3	4	5	3	3			
10	7	2	4	ND	ND	2	4	7	2	3			
11	11	14	7	2	3	3	3	6	2	4	2	ND	
12	8	8	5	ND	2	2	5	4	3	3	3	<2	
13	9	9	6	3	2	2	5	5	3	ND	ND	ND	
14	8	9	7	ND	3	2	3	4		5	ND	ND	
15	11	6	6	3	ND	4	5	4		2		<2	
16	15	5	6	ND	ND	5	5	4	3	ND		3	
17	<20	4	6	2	ND	4	7	4	3	3		3	
18	10	5	3	2	ND	4	6	5	3	3		3	
19	15		4	2	2	4	6	4	3	3		3	
20	12	8	3	4	2	4	4	5	3	3		3	
21	17	8	7	3	2	2	4			3		ND	
22	20	6	4	2	ND	4	6			3		ND	
23	4	6	4	2	2	3	4	2	3	3		ND	
24	4	6	10	ND	2		3	6	4	5	ND	3	
25		3	5	ND	3		4	6			ND	2	
26	5	5	4	ND	2	3	3	2			ND	3	
27	10	2	4	2	2	4	3	2	3		ND	4	
28	5	3	4	ND	2	4	3	ND	2	4	ND	2	
29	5		4	2	5	3	3	ND	4	3	ND	3	
30	3		2	3	3	3	4	ND	3		ND	ND	
31	3		5		2		2	ND				2	Annual Summary
<b>Ave</b>	8	5	5	1	2	3	4	3	2	3	1	1	3
<b>Min</b>	2	ND	ND	ND	ND	ND	2	ND	ND	ND	ND	ND	ND
<b>Max</b>	20	14	10	4	5	5	7	7	4	5	5	4	20

## D. Total Coliform Data Summaries

### 2013 Annual South Bay Water Reclamation Plant Total Coliform Report (MPN/ 100 ml)

SAMPLE DATE	RESULT	7-DAY MEDIAN	30-DAY AVERAGE	SAMPLE DATE	RESULT	7-DAY MEDIAN	30-DAY AVERAGE	SAMPLE DATE	RESULT	7-DAY MEDIAN	30-DAY AVERAGE
1-Jan-13	< 1.8	< 1.8	< 1.8	1-Mar-13	< 1.8	< 1.8	< 1.8	1-May-13	< 1.8	< 1.8	< 1.8
2-Jan-13	NS	< 1.8	< 1.8	2-Mar-13	< 1.8	< 1.8	< 1.8	2-May-13	< 1.8	< 1.8	< 1.8
3-Jan-13	NS	< 1.8	< 1.8	3-Mar-13	< 1.8	< 1.8	< 1.8	3-May-13	< 1.8	< 1.8	< 1.8
4-Jan-13	2.0	< 1.8	< 1.8	4-Mar-13	< 1.8	< 1.8	< 1.8	4-May-13	< 1.8	< 1.8	< 1.8
5-Jan-13	< 1.8	< 1.8	< 1.8	5-Mar-13	< 1.8	< 1.8	< 1.8	5-May-13	< 1.8	< 1.8	< 1.8
6-Jan-13	NS	< 1.8	< 1.8	6-Mar-13	< 1.8	< 1.8	< 1.8	6-May-13	< 1.8	< 1.8	< 1.8
7-Jan-13	< 1.8	< 1.8	< 1.8	7-Mar-13	< 1.8	< 1.8	< 1.8	7-May-13	4.5	< 1.8	< 1.8
8-Jan-13	< 1.8	< 1.8	< 1.8	8-Mar-13	< 1.8	< 1.8	< 1.8	8-May-13	< 1.8	< 1.8	< 1.8
9-Jan-13	< 1.8	< 1.8	< 1.8	9-Mar-13	< 1.8	< 1.8	< 1.8	9-May-13	< 1.8	< 1.8	< 1.8
10-Jan-13	< 1.8	< 1.8	< 1.8	10-Mar-13	< 1.8	< 1.8	< 1.8	10-May-13	< 1.8	< 1.8	< 1.8
11-Jan-13	< 1.8	< 1.8	< 1.8	11-Mar-13	< 1.8	< 1.8	< 1.8	11-May-13	< 1.8	< 1.8	< 1.8
12-Jan-13	< 1.8	< 1.8	< 1.8	12-Mar-13	< 1.8	< 1.8	< 1.8	12-May-13	< 1.8	< 1.8	< 1.8
13-Jan-13	NA	< 1.8	< 1.8	13-Mar-13	< 1.8	< 1.8	< 1.8	13-May-13	< 1.8	< 1.8	< 1.8
14-Jan-13	< 1.8	< 1.8	< 1.8	14-Mar-13	4.5	< 1.8	< 1.8	14-May-13	< 1.8	< 1.8	< 1.8
15-Jan-13	NS	< 1.8	< 1.8	15-Mar-13	< 1.8	< 1.8	< 1.8	15-May-13	< 1.8	< 1.8	< 1.8
16-Jan-13	NS	< 1.8	< 1.8	16-Mar-13	< 1.8	< 1.8	< 1.8	16-May-13	< 1.8	< 1.8	< 1.8
17-Jan-13	< 1.8	< 1.8	< 1.8	17-Mar-13	< 1.8	< 1.8	< 1.8	17-May-13	< 1.8	< 1.8	< 1.8
18-Jan-13	2.0	< 1.8	< 1.8	18-Mar-13	< 1.8	< 1.8	< 1.8	18-May-13	< 1.8	< 1.8	< 1.8
19-Jan-13	< 1.8	< 1.8	< 1.8	19-Mar-13	< 1.8	< 1.8	< 1.8	19-May-13	< 1.8	< 1.8	< 1.8
20-Jan-13	< 1.8	< 1.8	< 1.8	20-Mar-13	< 1.8	< 1.8	< 1.8	20-May-13	< 1.8	< 1.8	< 1.8
21-Jan-13	< 1.8	< 1.8	< 1.8	21-Mar-13	< 1.8	< 1.8	< 1.8	21-May-13	2.0	< 1.8	< 1.8
22-Jan-13	< 1.8	< 1.8	< 1.8	22-Mar-13	< 1.8	< 1.8	< 1.8	22-May-13	< 1.8	< 1.8	< 1.8
23-Jan-13	< 1.8	< 1.8	< 1.8	23-Mar-13	1.8	< 1.8	< 1.8	23-May-13	< 1.8	< 1.8	< 1.8
24-Jan-13	< 1.8	< 1.8	< 1.8	24-Mar-13	6.8	< 1.8	< 1.8	24-May-13	2.0	< 1.8	< 1.8
25-Jan-13	< 1.8	< 1.8	< 1.8	25-Mar-13	4.5	< 1.8	< 1.8	25-May-13	2.0	< 1.8	< 1.8
26-Jan-13	< 1.8	< 1.8	< 1.8	26-Mar-13	< 1.8	< 1.8	< 1.8	26-May-13	2.0	2.0	< 1.8
27-Jan-13	NS	< 1.8	< 1.8	27-Mar-13	< 1.8	< 1.8	< 1.8	27-May-13	4.0	2.0	< 1.8
28-Jan-13	9.3	< 1.8	< 1.8	28-Mar-13	< 1.8	< 1.8	< 1.8	28-May-13	< 1.8	2.0	< 1.8
29-Jan-13	NS	< 1.8	< 1.8	29-Mar-13	< 1.8	< 1.8	< 1.8	29-May-13	2.0	2.0	< 1.8
30-Jan-13	< 1.8	< 1.8	< 1.8	30-Mar-13	< 1.8	< 1.8	< 1.8	30-May-13	< 1.8	2.0	< 1.8
31-Jan-13	< 1.8	< 1.8	< 1.8	31-Mar-13	< 1.8	< 1.8	< 1.8	31-May-13	< 1.8	2.0	< 1.8
1-Feb-13	< 1.8	< 1.8	< 1.8	1-Apr-13	< 1.8	< 1.8	< 1.8	1-Jun-13	< 1.8	< 1.8	< 1.8
2-Feb-13	< 1.8	< 1.8	< 1.8	2-Apr-13	< 1.8	< 1.8	< 1.8	2-Jun-13	< 1.8	< 1.8	< 1.8
3-Feb-13	< 1.8	< 1.8	< 1.8	3-Apr-13	< 1.8	< 1.8	< 1.8	3-Jun-13	< 1.8	< 1.8	< 1.8
4-Feb-13	< 1.8	< 1.8	< 1.8	4-Apr-13	2.0	< 1.8	< 1.8	4-Jun-13	< 1.8	< 1.8	< 1.8
5-Feb-13	< 1.8	< 1.8	< 1.8	5-Apr-13	2.0	< 1.8	< 1.8	5-Jun-13	< 1.8	< 1.8	< 1.8
6-Feb-13	< 1.8	< 1.8	< 1.8	6-Apr-13	< 1.8	< 1.8	< 1.8	6-Jun-13	< 1.8	< 1.8	< 1.8
7-Feb-13	< 1.8	< 1.8	< 1.8	7-Apr-13	< 1.8	< 1.8	< 1.8	7-Jun-13	< 1.8	< 1.8	< 1.8
8-Feb-13	< 1.8	< 1.8	< 1.8	8-Apr-13	< 1.8	< 1.8	< 1.8	8-Jun-13	< 1.8	< 1.8	< 1.8
9-Feb-13	2.0	< 1.8	< 1.8	9-Apr-13	< 1.8	< 1.8	< 1.8	9-Jun-13	< 1.8	< 1.8	< 1.8
10-Feb-13	< 1.8	< 1.8	< 1.8	10-Apr-13	2.0	< 1.8	< 1.8	10-Jun-13	4.5	< 1.8	< 1.8
11-Feb-13	< 1.8	< 1.8	< 1.8	11-Apr-13	< 1.8	< 1.8	< 1.8	11-Jun-13	< 1.8	< 1.8	< 1.8
12-Feb-13	< 1.8	< 1.8	< 1.8	12-Apr-13	< 1.8	< 1.8	< 1.8	12-Jun-13	< 1.8	< 1.8	< 1.8
13-Feb-13	< 1.8	< 1.8	< 1.8	13-Apr-13	< 1.8	< 1.8	< 1.8	13-Jun-13	2.0	< 1.8	< 1.8
14-Feb-13	< 1.8	< 1.8	< 1.8	14-Apr-13	< 1.8	< 1.8	< 1.8	14-Jun-13	< 1.8	< 1.8	< 1.8
15-Feb-13	< 1.8	< 1.8	< 1.8	15-Apr-13	2.0	< 1.8	< 1.8	15-Jun-13	< 1.8	< 1.8	< 1.8
16-Feb-13	< 1.8	< 1.8	< 1.8	16-Apr-13	< 1.8	< 1.8	< 1.8	16-Jun-13	< 1.8	< 1.8	< 1.8
17-Feb-13	< 1.8	< 1.8	< 1.8	17-Apr-13	< 1.8	< 1.8	< 1.8	17-Jun-13	2.0	< 1.8	< 1.8
18-Feb-13	< 1.8	< 1.8	< 1.8	18-Apr-13	< 1.8	< 1.8	< 1.8	18-Jun-13	2.0	< 1.8	< 1.8
19-Feb-13	< 1.8	< 1.8	< 1.8	19-Apr-13	< 1.8	< 1.8	< 1.8	19-Jun-13	< 1.8	< 1.8	< 1.8
20-Feb-13	< 1.8	< 1.8	< 1.8	20-Apr-13	< 1.8	< 1.8	< 1.8	20-Jun-13	2.0	< 1.8	< 1.8
21-Feb-13	< 1.8	< 1.8	< 1.8	21-Apr-13	1.8	< 1.8	< 1.8	21-Jun-13	< 1.8	< 1.8	< 1.8
22-Feb-13	< 1.8	< 1.8	< 1.8	22-Apr-13	< 1.8	< 1.8	< 1.8	22-Jun-13	< 1.8	< 1.8	< 1.8
23-Feb-13	< 1.8	< 1.8	< 1.8	23-Apr-13	< 1.8	< 1.8	< 1.8	23-Jun-13	< 1.8	< 1.8	< 1.8
24-Feb-13	< 1.8	< 1.8	< 1.8	24-Apr-13	< 1.8	< 1.8	< 1.8	24-Jun-13	< 1.8	< 1.8	< 1.8
25-Feb-13	< 1.8	< 1.8	< 1.8	25-Apr-13	< 1.8	< 1.8	< 1.8	25-Jun-13	< 1.8	< 1.8	< 1.8
26-Feb-13	< 1.8	< 1.8	< 1.8	26-Apr-13	2.0	< 1.8	< 1.8	26-Jun-13	< 1.8	< 1.8	< 1.8
27-Feb-13	< 1.8	< 1.8	< 1.8	27-Apr-13	< 1.8	< 1.8	< 1.8	27-Jun-13	2.0	< 1.8	< 1.8
28-Feb-13	4.5	< 1.8	< 1.8	28-Apr-13	< 1.8	< 1.8	< 1.8	28-Jun-13	2.0	< 1.8	< 1.8
				29-Apr-13	< 1.8	< 1.8	< 1.8	29-Jun-13	2.0	< 1.8	< 1.8
				30-Apr-13	< 1.8	< 1.8	< 1.8	30-Jun-13	< 1.8	< 1.8	< 1.8

NS= not sampled

NA= not analyzed

**2013 Annual South Bay Water Reclamation Plant  
Total Coliform Report (MPN/ 100 ml)**

SAMPLE DATE	RESULT	7-DAY MEDIAN	30-DAY AVERAGE	SAMPLE DATE	RESULT	7-DAY MEDIAN	30-DAY AVERAGE	SAMPLE DATE	RESULT	7-DAY MEDIAN	30-DAY AVERAGE
1-Jul-13	< 1.8	< 1.8	< 1.8	1-Sep-13	< 1.8	< 1.8	< 1.8	1-Nov-13	< 1.8	< 1.8	< 1.8
2-Jul-13	2.0	2.0	< 1.8	2-Sep-13	< 1.8	< 1.8	< 1.8	2-Nov-13	< 1.8	< 1.8	< 1.8
3-Jul-13	2.0	2.0	< 1.8	3-Sep-13	< 1.8	< 1.8	< 1.8	3-Nov-13	< 1.8	< 1.8	< 1.8
4-Jul-13	2.0	2.0	< 1.8	4-Sep-13	< 1.8	< 1.8	< 1.8	4-Nov-13	< 1.8	< 1.8	< 1.8
5-Jul-13	< 1.8	2.0	< 1.8	5-Sep-13	< 1.8	< 1.8	< 1.8	5-Nov-13	< 1.8	< 1.8	< 1.8
6-Jul-13	< 1.8	< 1.8	< 1.8	6-Sep-13	< 1.8	< 1.8	< 1.8	6-Nov-13	< 1.8	< 1.8	< 1.8
7-Jul-13	< 1.8	< 1.8	< 1.8	7-Sep-13	4.5	< 1.8	< 1.8	7-Nov-13	< 1.8	< 1.8	< 1.8
8-Jul-13	< 1.8	< 1.8	< 1.8	8-Sep-13	79.0	< 1.8	3.8	8-Nov-13	< 1.8	< 1.8	< 1.8
9-Jul-13	< 1.8	< 1.8	< 1.8	9-Sep-13	< 1.8	< 1.8	3.4	9-Nov-13	13.0	< 1.8	< 1.8
10-Jul-13	< 1.8	< 1.8	< 1.8	10-Sep-13	< 1.8	< 1.8	3.3	10-Nov-13	< 1.8	< 1.8	< 1.8
11-Jul-13	< 1.8	< 1.8	< 1.8	11-Sep-13	2.0	< 1.8	3.4	11-Nov-13	< 1.8	< 1.8	< 1.8
12-Jul-13	< 1.8	< 1.8	< 1.8	12-Sep-13	< 1.8	< 1.8	3.4	12-Nov-13	< 1.8	< 1.8	< 1.8
13-Jul-13	< 1.8	< 1.8	< 1.8	13-Sep-13	< 1.8	< 1.8	3.4	13-Nov-13	< 1.8	< 1.8	< 1.8
14-Jul-13	< 1.8	< 1.8	< 1.8	14-Sep-13	< 1.8	< 1.8	3.4	14-Nov-13	< 1.8	< 1.8	< 1.8
15-Jul-13	< 1.8	< 1.8	< 1.8	15-Sep-13	4.5	< 1.8	3.5	15-Nov-13	< 1.8	< 1.8	< 1.8
16-Jul-13	< 1.8	< 1.8	< 1.8	16-Sep-13	< 1.8	< 1.8	3.4	16-Nov-13	< 1.8	< 1.8	< 1.8
17-Jul-13	< 1.8	< 1.8	< 1.8	17-Sep-13	< 1.8	< 1.8	3.1	17-Nov-13	< 1.8	< 1.8	< 1.8
18-Jul-13	NS	< 1.8	< 1.8	18-Sep-13	< 1.8	< 1.8	3.1	18-Nov-13	< 1.8	< 1.8	< 1.8
19-Jul-13	< 1.8	< 1.8	< 1.8	19-Sep-13	< 1.8	< 1.8	3.1	19-Nov-13	< 1.8	< 1.8	< 1.8
20-Jul-13	< 1.8	< 1.8	< 1.8	20-Sep-13	< 1.8	< 1.8	3.1	20-Nov-13	NS	< 1.8	< 1.8
21-Jul-13	< 1.8	< 1.8	< 1.8	21-Sep-13	< 1.8	< 1.8	3.1	21-Nov-13	2.0	< 1.8	< 1.8
22-Jul-13	7.8	< 1.8	< 1.8	22-Sep-13	< 1.8	< 1.8	3.1	22-Nov-13	< 1.8	< 1.8	< 1.8
23-Jul-13	2.0	< 1.8	< 1.8	23-Sep-13	< 1.8	< 1.8	3.1	23-Nov-13	< 1.8	< 1.8	< 1.8
24-Jul-13	< 1.8	< 1.8	< 1.8	24-Sep-13	< 1.8	< 1.8	3.0	24-Nov-13	NS	< 1.8	< 1.8
25-Jul-13	2.0	< 1.8	< 1.8	25-Sep-13	< 1.8	< 1.8	3.0	25-Nov-13	NS	< 1.8	< 1.8
26-Jul-13	7.8	2.0	< 1.8	26-Sep-13	7.8	< 1.8	3.3	26-Nov-13	NS	< 1.8	< 1.8
27-Jul-13	13	2.0	< 1.8	27-Sep-13	< 1.8	< 1.8	3.3	27-Nov-13	NS	< 1.8	< 1.8
28-Jul-13	4.5	4.5	< 1.8	28-Sep-13	< 1.8	< 1.8	3.3	28-Nov-13	7.8	< 1.8	< 1.8
29-Jul-13	1.8	2.0	< 1.8	29-Sep-13	2.0	< 1.8	3.3	29-Nov-13	< 1.8	< 1.8	< 1.8
30-Jul-13	< 1.8	2.0	< 1.8	30-Sep-13	< 1.8	< 1.8	3.3	30-Nov-13	6.8	< 1.8	< 1.8
31-Jul-13	130	4.5	5.8	1-Oct-13	< 1.8	< 1.8	3.3	1-Dec-13	< 1.8	< 1.8	< 1.8
1-Aug-13	13	7.8	6.3	2-Oct-13	< 1.8	< 1.8	3.3	2-Dec-13	< 1.8	< 1.8	< 1.8
2-Aug-13	33	13	7.3	3-Oct-13	< 1.8	< 1.8	3.3	3-Dec-13	NS	< 1.8	< 1.8
3-Aug-13	< 1.8	4.5	7.2	4-Oct-13	2.0	< 1.8	3.4	4-Dec-13	2.0	< 1.8	< 1.8
4-Aug-13	6.8	6.8	7.4	5-Oct-13	LA	< 1.8	3.4	5-Dec-13	NS	< 1.8	< 1.8
5-Aug-13	< 1.8	6.8	7.4	6-Oct-13	< 1.8	< 1.8	3.4	6-Dec-13	< 1.8	< 1.8	< 1.8
6-Aug-13	7.8	7.8	7.7	7-Oct-13	2.0	< 1.8	3.3	7-Dec-13	< 1.8	< 1.8	< 1.8
7-Aug-13	< 1.8	6.8	7.7	8-Oct-13	< 1.8	< 1.8	< 1.8	8-Dec-13	< 1.8	< 1.8	< 1.8
8-Aug-13	2.0	2.0	7.7	9-Oct-13	< 1.8	< 1.8	< 1.8	9-Dec-13	< 1.8	< 1.8	< 1.8
9-Aug-13	< 1.8	< 1.8	7.7	10-Oct-13	< 1.8	< 1.8	< 1.8	10-Dec-13	NS	< 1.8	< 1.8
10-Aug-13	13.0	2.0	8.2	11-Oct-13	2.0	< 1.8	< 1.8	11-Dec-13	< 1.8	< 1.8	< 1.8
11-Aug-13	2.0	2.0	8.2	12-Oct-13	< 1.8	< 1.8	< 1.8	12-Dec-13	NS	< 1.8	< 1.8
12-Aug-13	< 1.8	2.0	8.2	13-Oct-13	< 1.8	< 1.8	< 1.8	13-Dec-13	< 1.8	< 1.8	< 1.8
13-Aug-13	< 1.8	< 1.8	8.2	14-Oct-13	< 1.8	< 1.8	< 1.8	14-Dec-13	< 1.8	< 1.8	< 1.8
14-Aug-13	< 1.8	< 1.8	8.2	15-Oct-13	< 1.8	< 1.8	< 1.8	15-Dec-13	< 1.8	< 1.8	< 1.8
15-Aug-13	< 1.8	< 1.8	8.2	16-Oct-13	< 1.8	< 1.8	< 1.8	16-Dec-13	< 1.8	< 1.8	< 1.8
16-Aug-13	< 1.8	< 1.8	8.2	17-Oct-13	< 1.8	< 1.8	< 1.8	17-Dec-13	< 1.8	< 1.8	< 1.8
17-Aug-13	4.5	< 1.8	8.4	18-Oct-13	< 1.8	< 1.8	< 1.8	18-Dec-13	< 1.8	< 1.8	< 1.8
18-Aug-13	7.8	< 1.8	8.6	19-Oct-13	2.0	< 1.8	< 1.8	19-Dec-13	< 1.8	< 1.8	< 1.8
19-Aug-13	< 1.8	< 1.8	8.6	20-Oct-13	< 1.8	< 1.8	< 1.8	20-Dec-13	< 1.8	< 1.8	< 1.8
20-Aug-13	< 1.8	< 1.8	8.6	21-Oct-13	< 1.8	< 1.8	< 1.8	21-Dec-13	< 1.8	< 1.8	< 1.8
21-Aug-13	2.0	< 1.8	8.4	22-Oct-13	< 1.8	< 1.8	< 1.8	22-Dec-13	< 1.8	< 1.8	< 1.8
22-Aug-13	< 1.8	< 1.8	8.4	23-Oct-13	< 1.8	< 1.8	< 1.8	23-Dec-13	NS	< 1.8	< 1.8
23-Aug-13	< 1.8	< 1.8	8.4	24-Oct-13	< 1.8	< 1.8	< 1.8	24-Dec-13	NS	< 1.8	< 1.8
24-Aug-13	< 1.8	< 1.8	8.3	25-Oct-13	< 1.8	< 1.8	< 1.8	25-Dec-13	6.8	< 1.8	< 1.8
25-Aug-13	1.8	< 1.8	8.1	26-Oct-13	2.0	< 1.8	< 1.8	26-Dec-13	< 1.8	< 1.8	< 1.8
26-Aug-13	< 1.8	< 1.8	7.7	27-Oct-13	2.0	< 1.8	< 1.8	27-Dec-13	< 1.8	< 1.8	< 1.8
27-Aug-13	< 1.8	< 1.8	7.5	28-Oct-13	< 1.8	< 1.8	< 1.8	28-Dec-13	2.0	< 1.8	< 1.8
28-Aug-13	< 1.8	< 1.8	7.5	29-Oct-13	NS	< 1.8	< 1.8	29-Dec-13	< 1.8	< 1.8	< 1.8
29-Aug-13	< 1.8	< 1.8	7.5	30-Oct-13	< 1.8	< 1.8	< 1.8	30-Dec-13	< 1.8	< 1.8	< 1.8
30-Aug-13	< 1.8	< 1.8	3.1	31-Oct-13	< 1.8	< 1.8	< 1.8	31-Dec-13	< 1.8	< 1.8	< 1.8
31-Aug-13	< 1.8	< 1.8	2.7								

NS= not sampled

LA= lab accident

E. UV Performance 2013

UV PERFORMANCE REPORT  
CY 2013  
Monthly Averages

	2515	1852	2521	3088	3655	4219
	TRANS @ MIN UV DOSE (DUR. RW DEL)	UV MIN DOSE (DUR. RW DEL.)	B1 PWR @ MIN UV DOSE (DUR. RW DEL)	B2 PWR @ MIN UV DOSE (DUR. RW DEL)	B3 PWR @ MIN UV DOSE (DUR. RW DEL)	B4 PWR @ MIN UV DOSE (DUR. RW DEL)
Month	SB29TRANSRAW7475 pct	SB29DOSERAW7485 m j/cm 2	SB29QRAW7477 pct	SB29JRAW7479 pct	SB29JRAW7481 pct	SB29JRAW7483 pct
Jan 2013	64.00	152.95	55.50	51.00	55.50	55.50
Feb 2013	64.34	157.79	52.67	51.56	55.89	55.89
Mar 2013	65.31	157.72	52.88	51.56	54.94	54.94
Apr 2013	63.01	151.50	50.60	49.07	52.30	52.30
May 2013	65.90	161.78	56.58	54.90	58.32	57.58
Jun 2013	65.48	158.73	60.59	59.24	62.83	62.83
Jul 2013	64.37	165.74	67.26	66.16	68.97	68.84
Aug 2013	65.28	174.52	62.65	62.39	63.32	61.45
Sep 2013	67.24	174.03	64.93	63.83	64.43	67.13
Oct 2013	64.86	174.84	68.82	68.11	71.18	71.18
Nov 2013	66.14	171.81	55.69	52.06	56.63	59.88
Dec 2013	62.56	165.72	52.57	50.50	47.43	48.50
Average	64.87	163.93	58.39	56.70	59.31	59.67

This page left blank intentionally



VIII. Other Required Information.

- A. Notes on Specific Analysis
- B. Report of Operator Certification.

This page left blank intentionally

A. Notes on Specific Analyses:

1. It should be noted that some of the reference methods are equivalent. The organic priority pollutant analyses listed in E.P.A.'s Test Methods for Evaluating Solid Waste, Physical/Chemical Methods, SW-846 (ref. c) are equivalent to the methods E.P.A. prescribes for water in Methods for Chemical Analysis for Water and Wastes, (ref.a). Specifically wastewater methods 3510 and 8270 (ref.d) together are the same as the water method 625 (ref.a), and Method 8260B (ref. c) is equivalent to Method 624 (ref.a). Methods 3550 and 8270 together are equivalent to the E.P.A. Contract Laboratory Program's (ref. aa) method for ultrasonication and gas chromatograph-mass spectrographic analysis. The E.P.A.'s metals analyses for water (ref.a) generally just refers to the procedure in Standard Methods (ref. b, bb).

B. Report of Operator Certification.

Operator Certifications:

The following lists all Wastewater Treatment Plant Operators working for the Operating Units of the Public Utilities Department and their California State certification status as of May 2013. Name, Classification, Certification Grade, Certification Number, and expiration date are shown for each operator.

**South Bay Wastewater Reclamation Plant**

<b>First Name</b>	<b>Last Name</b>	<b>Classification</b>	<b>Grade</b>	<b>Number</b>	<b>Expiration Date</b>
Ernesto	Molas	Superintendent	V	7227	12/31/2015
Kip	Cooper	Senior Wastewater Ops Supv	V	9401	12/31/2015
Linda	Ruiz-Lopez	Wastewater Ops Supv. - PC	III	5660	12/31/2015
Doyle	Shankles	Wastewater Ops Supv.	III	7232	6/30/2014
Al	Johnson	Wastewater Operator	III	9638	6/30/2014
Teresa	Gardiner	Wastewater Ops Supv.	III	10657	12/31/2015
Herbert	Decatur	Wastewater Operator	III	28880	6/30/2015
Carol	Brassfield	Wastewater Operator	II	9383	12/31/2015
Douglas	Evans	Wastewater Operator	II	9844	6/30/2014
Romeo	Millan	Wastewater Operator	II	9846	6/30/2014

IX. Appendices

- A. Terms and Abbreviations used in this Report
- B. Methods of Analysis
- C. Frequency of Analysis and Type of Sample – 2013
- D. Laboratories Contributing Results used in this report
- E. Staff Contributing to this Report

This page left blank intentionally

A. Terms and Abbreviations used in this Report

Along with standard abbreviations the following is a list of local/uncommon abbreviations and terms for the readers' reference.

PLANT TERMS

U.S.EPA	- United States Environmental Protection Agency.
NPDES	- National Pollutant Discharge Elimination System.
WWTP	- Wastewater Treatment Plant.
WRP	- Water Reclamation Plant.
PLWTP or PLWWTP	- Pt. Loma Wastewater Treatment Plant
PLR	- Point Loma Raw (influent to the plant).
PLE	- Point Loma Effluent (effluent from the plant).
N-1-P	- North Digester Number 1, Primary, Pt. Loma
N-2-P	- North Digester Number 2, Primary, Pt. Loma
C-1-P	- Central Digester Number 1, Primary, Pt. Loma
C-2-P	- Central Digester Number 2, Primary, Pt. Loma
S-1-P	- South Digester Number 1, Primary, Pt. Loma
S-2-P	- South Digester Number 2, Primary, Pt. Loma
Dig 7	- Digester Number 7, Primary, Pt. Loma
Dig 8	- Digester Number 8, Primary, Pt. Loma
DIG COMP	- Digested Biosolids Composite; a composite of grabs taken from each of the in-service digesters.
RAW COMP	- A Composite of Raw Sludge taken over the preceding 24 hrs.
NCWRP	- North City Water Reclamation Plant
N01-PS_INF	- The plant primary Influent from Pump Station 64
N01-PEN	- The plant primary Influent from the Penasquitos pump station.
N30-DFE	- Disinfected Final Effluent
N34-REC WATER	- Reclaimed Water.
N10-PSP COMB	- raw sludge
N15-WAS LCP	- Waste Activated Sludge – low capacity pumps
SBOO	- South Bay Ocean Outfall or South Bay Outfall
SB_INF_02	- The plant Influent
SB_OUTFALL_01	- The plant discharge to ocean effluent
SB_ITP_COMB_EFF	-The plant discharge to ocean and International Waste Treatment Plant combined effluents
SB_PRI_EFF_01	- The plant primary Influent
SB_SEC_EFF_00	-The plant secondary Influent
SB_REC_WATER_34	- Reclaimed Water
SB_RSL_10	- The plant primary sedimentation tank to raw sludge line
MBC	- Metro Biosolids Center
MBCDEWCN	- Metro Biosolids Center Dewatering Centrifuges; typically the dewatered biosolids from these.
MBC_COMBCN	- MBC Combined Centrate; the centrate from all the dewatering centrifuges. (The return stream from MBC to the sewer system.)
MBC_NC_DSL	- North City to Metropolitan Biosolids Center (MBC) Digested Sludge Line.
Dig 1	- MBC Digester number 1.
Dig 2	- MBC Digester number 2.
Dig 3	- MBC Digester number 3.
Biosolids	- In most cases Biosolids and digested (a processed) Sludge is synonymous.
Field Replicate	- Separate samples collected at approximately the same time from the same sample site.

## UNITS

mg/L	.....	milligrams per liter
ug/L	.....	micrograms per liter = 0.001 mg/L
ng/L	.....	nanograms per liter = 0.001 ug/L
mg/Kg	.....	milligrams per kilogram
ug/Kg	.....	micrograms per kilogram
ng/Kg	.....	nanograms per kilogram
pg/L	.....	picograms per liter
pg/Kg	.....	picograms per kilogram
pc/L or pCi/L	.....	pico curies per liter
TU	.....	toxicity units
ntu	.....	nephelometric turbidity units
°C	.....	degrees Celsius = degrees centigrade
MGD/mgd	.....	million gallons per day
umhos/cm.	.....	micromhos per centimeter
uS	.....	microsiemens = umhos
mils/100 mL	.....	millions per 100 milliliters
nd	.....	not detected
NA	.....	not analyzed (when in a data column)
NR	.....	not required
NS	.....	not sampled
LA	.....	lab accident

## CHEMICAL TERMS & ABBREVIATIONS:

AA	.....	Atomic Absorption Spectroscopy
BOD	.....	Biochemical Oxygen Demand
CN <sup>-</sup>	.....	Cyanide
COD	.....	Chemical Oxygen Demand
Cr <sup>6+</sup>	.....	Hexavalent Chromium
D.O.	.....	Dissolved Oxygen
DDD	.....	Dichlorodiphenyldichloroethane a.k.a. TDE-tetrachlorodiphenylethane)
DDE	.....	Dichlorodiphenyldichloroethylene
DDT	.....	Dichlorodiphenyltrichloroethane
FeCl <sub>3</sub>	.....	Ferric Chloride
G&O	.....	Grease and Oil
GC	.....	Gas chromatography.
GC-ECD	.....	-Electron Capture Detector.
GC-FID	.....	-Flame Ionization Detector.
GC-FPD	.....	-Flame Photometric Detector.
GC-MS	.....	-Mass Spectroscopy.
H <sub>2</sub> S	.....	Hydrogen Sulfide
Hg	.....	Mercury
IC	.....	Ion Chromatography
Induct	.....	ICP-AES Inductively Coupled Plasma- Atomic Emission Spectroscopy
MDL	.....	Method Detection Limit
MSD	.....	Mass Spectroscopy Detector
NH <sub>3</sub>	.....	Ammonia
NH <sub>3</sub> -N	.....	Ammonia Nitrogen
NH <sub>4</sub> <sup>+</sup>	.....	Ammonium ion
NO <sub>3</sub> <sup>-</sup>	.....	Nitrate
PAD	.....	Pulsed Amperometric Detector
PCB	.....	Polychlorinated Biphenyls
PO <sub>4</sub> <sup>3-</sup>	.....	Phosphate
SO <sub>4</sub> <sup>2-</sup>	.....	Sulfate
SS	.....	Suspended Solids
TBT	.....	Tributyl tin
TCH	.....	Total Chlorinated Hydrocarbons (i.e. chlorinated pesticides & PCB's)
TCLP	.....	Toxicity Characteristic Leaching Procedure
TDS	.....	Total Dissolved Solids
TQ	.....	Triple Quad
TS	.....	Total Solids
TVS	.....	Total Volatile Solids
VSS	.....	Volatile Suspended Solids



## B. Methods of Analysis

### WASTEWATER INFLUENT and EFFLUENT (General)

Analyte	Description	Instrumentation	Reference <sup>1</sup>
Alkalinity	Selected Endpoint Titration	Mettler DL-21 & 25 Titrator Orion 950	(i) 2320 B
Ammonia Nitrogen	Distillation and Titration	Buchi Distillation Unit K-314, B-324, K-350 Orion 950 pH Meter Mettler DL25 titrator	(i) 4500-NH3 B & C
Biochemical Oxygen Demand (BOD-5 Day)	Dissolved Oxygen Meter with Dissolved Oxygen Probe	YSI-5000 DO Meter YSI-5100 DO Meter YSI 59 DO Meter (5905 Probe)	(i) 5210 B
Biochemical Oxygen Demand (BOD-Soluble)	Dissolved Oxygen Probe	YSI-5000 DO Meter YSI-5100 DO Meter YSI 59 DO Meter (5905 Probe)	(i) 5210 B
Chemical Oxygen Demand (COD)	Closed Reflux / Colorimetric	Hach DR-2010 UV/Vis spectrophotometer	HACH 8000
Conductivity	Conductivity Meter with Wheatstone Bridge probe	YSI-3100, YSI-3200, Orion 115A, Orion 250, Accumet Model 150	(g) 2510 B
Cyanide	Acid Digest/Distil./Colorimetric	Hach DR-4000/Vis	(i) 4500-CN E
Floating Particulates	Flotation Funnel	Mettler AX-105 Mettler AG 204 Balance	(g) 2530 B
Flow	Continuous Meter	Gould (pressure sensor), ADS (sonic sensor), or Venturi (velocity sensor)	
Hardness; Ca, Mg, Total	ICP-AES / Calculation	TJA IRIS	(a) 200.7 (h) 2340 B
Kjeldahl Nitrogen (TKN)	Macro-Digestion / Titration	Labconco digestion block Buchi B-324 distiller & Mettler DL25 titrator	(i) Digestion= 4500-Norg B
Oil and Grease	Hexane Extraction / Gravimetric	Mettler AX-105 Balance	(a) 1664A
Organic Carbon (TOC)	Catalytic Oxidation / IR Water Production Laboratory)	Shimadzu ASI-5000	(f) 5310 B
pH	Hydrogen+Reference Electrode	Various models of pH meters.	(i) 4500-H+ B
Radiation (alpha & beta)	Alpha Spectroscopy Gamma Spectroscopy	Canberra 7401 (alpha) Canberra GC25185 (beta)	(h) 7110 B
Solids, Dissolved-Total	Gravimetric @ 180°C using analytical balance	Mettler AG204, AX105, AB204	(i) 2540 C
Solids, Settleable	Volumetric	Imhoff Cone	(i) 2540 F
Solids, Suspended-Total	Gravimetric @ 103-105°C	Mettler AG204, AX105, AB204	(i) 2540 D
Solids, Suspended-Volatile	Gravimetric @ 500°C	Mettler AG204, AX105, AB204	(i) 2540 E
Solids, Total	Gravimetric @ 103-105°C	Mettler AG204, AX105, AB204	(a) 160.3
Solids, Total-Volatile	Gravimetric @ 500°C	Mettler AG204, AX105, AB204	(a) 160.4
Temperature	Direct Reading	Fisher Digital Thermometer	(g) 2550 B
Turbidity	Nephelometer Turbidimeter	Hach 2100-N Meter Hach 2100-AN Meter	(g) 2130 B
Bromide, Chloride, Fluoride, Nitrate, Phosphate, Sulfate	Ion Chromatography	Dionex ICS-3000	(d) 300.0

<sup>1</sup> Reference listing is found following this listing of analytical methods.

WASTEWATER INFLUENT and EFFLUENT (Metals)

Analyte	Description	Instrumentation	Reference <sup>1</sup>
Aluminum	Acid Digestion / ICP-AES	TJA IRIS INTREPID II	(e) 200.7
Antimony	Acid Digestion / ICP-AES	TJA IRIS INTREPID II	(e) 200.7
Arsenic	Hydride Generation / AA	TJA Solaar M6	(h) 3114 C
Barium	Acid Digestion / ICP-AES	TJA IRIS INTREPID II	(e) 200.7
Beryllium	Acid Digestion / ICP-AES	TJA IRIS INTREPID II	(e) 200.7
Boron	Acid Digestion / ICP-AES	TJA IRIS INTREPID II	(e) 200.7
Cadmium	Acid Digestion / ICP-AES	TJA IRIS INTREPID II	(e) 200.7
Calcium	Acid Digestion / ICP-AES	TJA IRIS ADVANTAGE	(e) 200.7
Chromium	Acid Digestion / ICP-AES	TJA IRIS INTREPID II	(e) 200.7
Cobalt	Acid Digestion / ICP-AES	TJA IRIS INTREPID II	(e) 200.7
Copper	Acid Digestion / ICP-AES	TJA IRIS INTREPID II	(e) 200.7
Iron	Acid Digestion / ICP-AES	TJA IRIS INTREPID II	(e) 200.7
Lead	Acid Digestion / ICP-AES	TJA IRIS INTREPID II	(e) 200.7
Lithium	Acid Digestion / ICP-AES	TJA IRIS ADVANTAGE	(e) 200.7
Magnesium	Acid Digestion / ICP-AES	TJA IRIS ADVANTAGE	(e) 200.7
Manganese	Acid Digestion / ICP-AES	TJA IRIS INTREPID II	(e) 200.7
Mercury	Thermal / AA	Milestone DMA80	(g) 3112 B
Mercury	Cold Vapor Generation / AF	Leeman Hydra Gold	(w) 1613E and 245.7
Molybdenum	Acid Digestion / ICP-AES	TJA IRIS INTREPID II	(e) 200.7
Nickel	Acid Digestion / ICP-AES	TJA IRIS INTREPID II	(e) 200.7
Potassium	Acid Digestion / ICP-AES	TJA IRIS ADVANTAGE	(e) 200.7
Selenium	Hydride Generation / AA	TJA Solaar M6	(h) 3114 C
Silver	Acid Digestion / ICP-AES	TJA IRIS INTREPID II	(e) 200.7
Sodium	Acid Digestion / ICP-AES	TJA IRIS ADVANTAGE	(e) 200.7
Thallium	Acid Digestion / ICP-AES	TJA IRIS INTREPID II	(e) 200.7
Vanadium	Acid Digestion / ICP-AES	TJA IRIS INTREPID II	(e) 200.7
Zinc	Acid Digestion / ICP-AES	TJA IRIS INTREPID II	(e) 200.7

- 1 Reference listing is found following this listing of analytical

WASTEWATER INFLUENT and EFFLUENT (Organics)

Analyte	Description	Instrumentation	Reference <sup>1</sup>
Acrolein and Acrylonitrile	Purge & Trap, GC-MSD	O-I Analytical Eclipse 4660/4552 Agilent-6890NGC /5973N MSD Capillary J&W DB-624	(c) 8260 B
Base/Neutral Extractables	Basic / CH <sub>2</sub> Cl <sub>2</sub> continuous extraction, GC-MSD	HP-6890GC / 5973MSD Capillary DB-5.625	(a) 625
Benzidines	Basic / CH <sub>2</sub> Cl <sub>2</sub> continuous extraction, GC-MSD	HP-6890GC / 5973MSD Capillary DB-5.625	(a) 625
Chlorinated Pesticides	CH <sub>2</sub> Cl <sub>2</sub> extraction, GC-ECD	Varian 3800 GC-ECD RTX-5/60m : RTX-1701/60m Varian 3800-Saturn 2000 DB-XLB Bruker 300-MS TQ	(a) 608
Dioxin	CH <sub>2</sub> Cl <sub>2</sub> extraction, GC/MS/MS	Varian Saturn -MS-MS Varian 3800 GC	(a) 8280A
Organophosphorus Pesticides	CH <sub>2</sub> Cl <sub>2</sub> extraction, hexane exchange, GC-PFPD	Varian 3800 GC-PFPD RTX-1 :RTX-50	(a) 622
Phenolic Compounds	Acidic / CH <sub>2</sub> Cl <sub>2</sub> continuous extraction, GC-MSD	HP-6890GC / 5973MSD Capillary DB-5.625	(a) 625
Purgeables (VOCs)	Purge & Trap, GC-MSD	O-I Analytical Eclipse 4660/4552 Agilent-6890NGC /5973N MSD Capillary J&W DB-624	(a) 8260B
Tri, Di, and Monobutyl Tin	CH <sub>2</sub> Cl <sub>2</sub> extraction, derivatization, hexane exchange, GC-FPD	Varian 3400 GC-FPD DB-1/30m : RTX-50	(l)

<sup>1</sup> Reference listing is found following this listing of analytical methods.

LIQUID SLUDGE: Raw, Digested, and Filtrate (General)

Analyte	Description	Instrumentation	Reference <sup>1</sup>
Alkalinity	Selected Endpoint Titration	Mettler DL-25 Titrator Orion 950	(g) 2320 B
Cyanide	Acid Digest-Distil / Colorimetric	Hach DR/4000V	(h) 4500-CN E
pH	Hydrogen+Reference Electrode	Various models of pH meters.	(c) 9010 B
Radiation (alpha & beta)	Alpha Spectroscopy Gamma Spectroscopy	Canberra 7401 (alpha) Canberra GC25185 (beta)	(h) 7110 B
Sulfides	Acid Digest-Distil / Titration	Class A Manual Buret	(c) 9030 B
Sulfides, reactive	Distillation / Titration	Class A Manual Buret	(c) 7.3.4.2
Solids, Total	Gravimetric @ 103-105°C	Mettler PB 4002-S Mettler PG 5002-S Mettler AB204	(i) 2540 B
Solids, Total-Volatile	Gravimetric @ 500°C	Mettler PB 4002-S Mettler PG 5002-S Mettler AB204	(i) 2540 E

LIQUID SLUDGE: Raw, Digested, and Filtrate (Metals)

Analyte	Description	Instrumentation	Reference <sup>1</sup>
Aluminum	Acid Digestion / ICP-AES	TJA IRIS INTREPID II	(c) 6010 B
Antimony	Acid Digestion / ICP-AES	TJA IRIS INTREPID II	(c) 6010 B
Arsenic	Hydride Generation / AA	TJA Solaar M6	(c) 7062
Beryllium	Acid Digestion / ICP-AES	TJA IRIS INTREPID II	(c) 6010 B
Barium	Acid Digestion / ICP-AES	TJA IRIS INTREPID II	(c) 6010 B
Boron	Acid Digestion / ICP-AES	TJA IRIS INTREPID II	(c) 6010 B
Cadmium	Acid Digestion / ICP-AES	TJA IRIS INTREPID II	(c) 6010 B
Chromium	Acid Digestion / ICP-AES	TJA IRIS INTREPID II	(c) 6010 B
Cobalt	Acid Digestion / ICP-AES	TJA IRIS INTREPID II	(c) 6010 B
Copper	Acid Digestion / ICP-AES	TJA IRIS INTREPID II	(c) 6010 B
Iron	Acid Digestion / ICP-AES	TJA IRIS INTREPID II	(c) 6010 B
Lead	Acid Digestion / ICP-AES	TJA IRIS INTREPID II	(c) 6010 B
Manganese	Acid Digestion / ICP-AES	TJA IRIS INTREPID II	(c) 6010 B
Mercury	Thermal / AA	Milestone DMA80	(c) 7471 A and 747.3
Mercury	TD / AA	Milestone DMA80	(c) 7471 A
Molybdenum	Acid Digestion / ICP-AES	TJA IRIS INTREPID II	(c) 6010 B
Nickel	Acid Digestion / ICP-AES	TJA IRIS INTREPID II	(c) 6010 B
Selenium	Hydride Generation / AA	TJA Solaar M6	(c) 7742
Silver	Acid Digestion / ICP-AES	TJA IRIS INTREPID II	(c) 6010 B
Thallium	Acid Digestion / ICP-AES	TJA IRIS INTREPID II	(c) 6010 B
Vanadium	Acid Digestion / ICP-AES	TJA IRIS INTREPID II	(c) 6010 B
Zinc	Acid Digestion / ICP-AES	TJA IRIS INTREPID II	(c) 6010 B

<sup>1</sup> Reference listing is found following this listing of analytical methods.

LIQUID SLUDGE: Raw, Digested, and Decant (Organics)

Analyte	Description	Instrumentation	Reference <sup>1</sup>
Acrolein and Acrylonitrile	Purge & Trap, GC-MSD	O-I Analytical Eclipse 4660/4552 Agilent-6890NGC /5973N MSD Capillary J&W DB-624	(c) 8260 B (b)
Base/Neutral Extractables	Basic / CH <sub>2</sub> Cl <sub>2</sub> continuous extraction, GC-MSD	HP-6890GC / 5973MSD Capillary DB-5.625	(a) 625 (b)
Benzidines	Basic / CH <sub>2</sub> Cl <sub>2</sub> continuous extraction, GC-MSD	HP-6890GC / 5973MSD Capillary DB-5.625	(a) 625
Chlorinated Pesticides	CH <sub>2</sub> Cl <sub>2</sub> extraction, GC-ECD	Varian 3800 GC-ECD RTX-5/60m : RTX-1701/60m Varian 3800-Saturn 2000 DB-XLB Bruker 300-MS TQ	(c) 8081 A
PCBs	CH <sub>2</sub> Cl <sub>2</sub> extraction, GC-ECD	Varian 3800 GC-ECD RTX-5/60m : RTX-1701/60m Varian 3800-Saturn 2000 DB-XLB Bruker 300-MS TQ	(c) 8082
Dioxin	CH <sub>2</sub> Cl <sub>2</sub> extraction	Varian GC-MS/MS	(c) 8280A
Organophosphorus Pesticides	CH <sub>2</sub> Cl <sub>2</sub> extraction, hexane exchange, GC-PFPD	Varian 3800 GC-PFPD RTX-1 : RTX-50	(a) 622
Phenolic Compounds	Acidic / CH <sub>2</sub> Cl <sub>2</sub> continuous extraction, GC-MSD	HP-6890GC / 5973MSD Capillary DB-5.625	(a) 625 (b)
Purgeables (VOCs)	Purge & Trap, GC-MSD	O-I Analytical Eclipse 4660/4552 Agilent-6890NGC /5973N MSD Capillary J&W DB-624	(c) 8260 B (b)
Tri, Di, and Monobutyl Tin	CH <sub>2</sub> Cl <sub>2</sub> extraction, derivatization, hexane exchange, GC-FPD	Varian 3400 GC-FPD DB-1/30m : RTX-50	(l)

LIQUID SLUDGE: Raw, Digested, and Decant (Digester Gases)

Analyte	Description	Instrumentation	Reference <sup>1</sup>
Methane	Gas Chromatography	SRI 8610C GC EG&G 100AGC	(i) 2720 C
Carbon Dioxide	Gas Chromatography	SRI 8610C GC EG&G 100AGC	(i) 2720 C
Hydrogen Sulfide	Colorimetric	Draeger H2S 2/a	

<sup>1</sup> Reference listing is found following this listing of analytical methods.

DRIED SLUDGE: Metro Biosolids Center (General)

Analyte	Description	Instrumentation	Reference <sup>1</sup>
Cyanide	Acid Digest-Distillation Colorimetric	Hach DR/4000V UV/Vis	(c) 9010 A
Cyanide Reactive	Distillation / Colorimetric	Hach DR/4000V UV/Vis	(c) 7.3.3.2 and 9014
pH	Hydrogen+Reference Electrode	Various models of pH meters.	(c) 9045 C
Radiation (alpha & beta)	Alpha Spectroscopy Gamma Spectroscopy	Canberra 7401 (alpha) Canberra GC25185 (beta)	(h) 7110 B
Sulfides	Acid Digest-Distil / Titration	Class A Manual Buret	(c) 9030 B and 9034
Sulfides, reactive	Distillation / Titration	Class A Manual Buret	(c) 7.3.4.2 and 9034
Solids, Total	Gravimetric @ 103-105 C°	Denver PI-314, Mettler AB204	(i) 2540 B
Solids, Total-Volatile	Gravimetric @ 500 C°	Denver PI-314, Mettler AB204	(i) 2540 E

DRIED SLUDGE: Metro Biosolids Center (Metals)

Analyte	Description	Instrumentation	Reference <sup>1</sup>
Aluminum	Acid Digestion / ICP-AES	TJA IRIS INTREPID II	(c) 6010 B
Antimony	Acid Digestion / ICP-AES	TJA IRIS INTREPID II	(c) 6010 B
Arsenic	Hydride Generation / AA	TJA Solaar M6	(c) 7062
Barium	Acid Digestion / ICP-AES	TJA IRIS INTREPID II	(c) 6010 B
Beryllium	Acid Digestion / ICP-AES	TJA IRIS INTREPID II	(c) 6010 B
Boron	Acid Digestion / ICP-AES	TJA IRIS INTREPID II	(c) 6010 B
Cadmium	Acid Digestion / ICP-AES	TJA IRIS INTREPID II	(c) 6010 B
Chromium	Acid Digestion / ICP-AES	TJA IRIS INTREPID II	(c) 6010 B
Cobalt	Acid Digestion / ICP-AES	TJA IRIS INTREPID II	(c) 6010 B
Copper	Acid Digestion / ICP-AES	TJA IRIS INTREPID II	(c) 6010 B
Iron	Acid Digestion / ICP-AES	TJA IRIS INTREPID II	(c) 6010 B
Lead	Acid Digestion / ICP-AES	TJA IRIS INTREPID II	(c) 6010 B
Manganese	Acid Digestion / ICP-AES	TJA IRIS INTREPID II	(c) 6010 B
Mercury	Thermal / AA	Milestone DMA80	(c) 7471 A
Mercury	TD / AA	Leeman Hydra Gold	(c) 7471 A
Molybdenum	Acid Digestion / ICP-AES	TJA IRIS INTREPID II	(c) 6010 B
Nickel	Acid Digestion / ICP-AES	TJA IRIS INTREPID II	(c) 6010 B
Selenium	Hydride Generation / AA	TJA Solaar M6	(c) 7742
Silver	Acid Digestion / ICP-AES	TJA IRIS INTREPID II	(c) 6010 B
Thallium	Acid Digestion / ICP-AES	TJA IRIS INTREPID II	(c) 6010 B
Vanadium	Acid Digestion / ICP-AES	TJA IRIS INTREPID II	(c) 6010 B
Zinc	Acid Digestion / ICP-AES	TJA IRIS INTREPID II	(c) 6010 B

Waste Extraction Test (WET)	Extraction with Sodium Citrate ICP-AES	Burrel wrist action shaker TJA IRIS	(j) Section 66261.100
-----------------------------	--	--	-----------------------

<sup>1</sup> Reference listing is found following this listing of analytical methods.

DRIED SLUDGE: Metro Biosolids Center (Organics)

Analyte	Description	Instrumentation	Reference <sup>1</sup>
Acrolein and Acrylonitrile	Purge & Trap, GC-MSD	O-I Analytical Eclipse 4660/4552 Agilent-6890NGC /5973N MSD Capillary J&W DB-624	(c) 8260 B
Base/Neutral Extractables	CH <sub>2</sub> Cl <sub>2</sub> /Acetone sonication extraction, GC-MSD	Agilent-7890GC / 5975MSD Capillary DB-5.625	(c) 8270 C (c) 3550 A
Chlorinated Pesticides	CH <sub>2</sub> Cl <sub>2</sub> extraction, GC-ECD	Varian 3800 GC-ECD RTX-5/60m : RTX-1701/60m Varian 3800-Saturn 2000 DB-XLB Bruker 300-MS TQ	(c) 8081 A
PCBs	CH <sub>2</sub> Cl <sub>2</sub> extraction, GC-ECD	Varian 3800 GC-ECD RTX-5/60m : RTX-1701/60m Varian 3800-Saturn 2000 DB-XLB Bruker 300-MS TQ	(c) 8082
Dioxin	Outside Contact (Test America)	GC-MS	(a) 8290
Organophosphorus Pesticides	CH <sub>2</sub> Cl <sub>2</sub> extraction, hexane exchange, GC-PFPD	Varian 3800 GC-PFPD DB-1/30m DB-608/30m	(c) 8141 A
Phenolic Compounds	CH <sub>2</sub> Cl <sub>2</sub> / Acetone sonication extraction, GC-MSD	HP-5890GC / 5972MSD Agilent-78906GC / 5975MSD Capillary DB-5.625	(c) 8270 C (c) 3550 A
Purgeables (VOCs)	Purge & Trap, GC-MSD	O-I Analytical Eclipse 4660/4552 Agilent-6890NGC /5973N MSD Capillary J&W DB-624	(c) 8260 B
Tri, Di, and Monobutyl Tin	CH <sub>2</sub> Cl <sub>2</sub> extraction, derivatization, hexane exchange, GC-FPD	Varian 3400 GC-FPD DB-1/30m DB-608/30m	(l)
Total Nitrogen (TN)	Combustion / GC-TCD	Carlo-Erba NC-2500 Porapak QS	(m) 9060

<sup>1</sup> Reference listing is found following this listing of analytical methods.

OCEAN SEDIMENT (General)

Analyte	Description	Instrumentation	Reference <sup>1</sup>
Biochemical Oxygen Demand (BOD-5 Day)	Dissolved Oxygen Probe	YSI-5000 DO Meter	(g) 5210 B
Particle Size	Coarse fraction by sieve; fine fraction by laser scatter	Horiba LA-920	(q) 3-380
Sulfides	Acid Digest-Distil / IC-PAD	Dionex ICS 3000-PAD(Ag)	(k)
Solids, Total	Gravimetric @ 103-105 C°	AND HM-120	(g) 2540 B
Solids, Total-Volatile	Gravimetric @ 500 C°	AND HM-120	(g) 2540 E
Total Organic Carbon (TOC) and Total Nitrogen (TN)	Combustion / GC-TCD	Carlo-Erba NC-2500 Porapak QS	(c) 9060 (m)

OCEAN SEDIMENT (Metals)

Analyte	Description	Instrumentation	Reference <sup>1</sup>
Aluminum	Acid Digestion / ICP-AES	TJA IRIS INTREPID II	(c) 6010 B
Antimony	Acid Digestion / ICP-AES	TJA IRIS INTREPID II	(c) 6010 B
Arsenic	Hydride Generation / AA	TJA Solaar M6	(c) 7062
Beryllium	Acid Digestion / ICP-AES	TJA IRIS INTREPID II	(c) 6010 B
Cadmium	Acid Digestion / ICP-AES	TJA IRIS INTREPID II	(c) 6010 B
Chromium	Acid Digestion / ICP-AES	TJA IRIS INTREPID II	(c) 6010 B
Copper	Acid Digestion / ICP-AES	TJA IRIS INTREPID II	(c) 6010 B
Iron	Acid Digestion / ICP-AES	TJA IRIS INTREPID II	(c) 6010 B
Lead	Acid Digestion / ICP-AES	TJA IRIS INTREPID II	(c) 6010 B
Manganese	Acid Digestion / ICP-AES	TJA IRIS INTREPID II	(c) 6010 B
Mercury	Thermal / AA	Milestone DMA80	(c) 7471 A
Mercury	Cold Vapor Generation / AF	Leeman Hydra Gold	(c) 7471 A
Nickel	Acid Digestion / ICP-AES	TJA IRIS INTREPID II	(c) 6010 B
Selenium	Hydride Generation / AA	TJA Solaar M6	(c) 7742
Silver	Acid Digestion / ICP-AES	TJA IRIS INTREPID II	(c) 6010 B
Thallium	Acid Digestion / ICP-AES	TJA IRIS INTREPID II	(c) 6010 B
Tin	Acid Digestion / ICP-AES	TJA IRIS INTREPID II	(c) 6010 B
Zinc	Acid Digestion / ICP-AES	TJA IRIS INTREPID II	(c) 6010 B

OCEAN SEDIMENT (Organics)

Analyte	Description	Instrumentation	Reference <sup>1</sup>
Base/Neutral Extractables	CH <sub>2</sub> Cl <sub>2</sub> / Acetone ASE GC-MSD	Agilent-7890GC / 5975MSD Capillary DB-5.625	(c) 8270 C (b) 3545A
Chlorinated Pesticides	CH <sub>2</sub> Cl <sub>2</sub> extraction, GC-ECD/MS/MS	Varian Saturn GC-ECD/MS/MS DBXLB/60m	(c) 8081 A 3545A
PCBs as Congeners	CH <sub>2</sub> Cl <sub>2</sub> extraction, GC-ECD/MS/MS	Varian Saturn GC-ECD/MS/MS DBXLB/60m	(c) 8082 3545A
Organophosphorus Pesticides	CH <sub>2</sub> Cl <sub>2</sub> extraction, hexane exchange, GC-PFPD	Varian 3800 GC-PFPD RTX-1 : RTX-50	(c) 8141 A
Tri, Di, and Monobutyl Tin	CH <sub>2</sub> Cl <sub>2</sub> extraction, derivatization, hexane exchange, GC-FPD	Varian 3400 GC-FPD DB-1/30m : RTX_50	(l)

<sup>1</sup> Reference listing is found following this listing of analytical methods.

FISH TISSUE: Liver, Muscle, and Whole (General)

Analyte	Description	Instrumentation	Reference <sup>1</sup>
Solids, Total	Freeze Drying Gravimetric	Labconco Freezone 6 Mettler AG-104 Balance	(n)
Lipids	Hexane/Acetone Extraction Gravimetric	Dionex ASE-200 Mettler AG-104 Balance	(o)

FISH TISSUE: Liver, Muscle, and Whole (Metals)

Analyte	Description	Instrumentation	Reference <sup>1</sup>
Aluminum	Acid Digestion / ICP-AES	TJA IRIS INTREPID II	(e) 200.3 / 200.7
Antimony	Acid Digestion / ICP-AES	TJA IRIS INTREPID II	(e) 200.3 / 200.7
Arsenic	Acid Digestion / ICP-AES	TJA IRIS INTREPID II	(e) 200.3 / 200.7
Beryllium	Acid Digestion / ICP-AES	TJA IRIS INTREPID II	(e) 200.3 / 200.7
Cadmium	Acid Digestion / ICP-AES	TJA IRIS INTREPID II	(e) 200.3 / 200.7
Chromium	Acid Digestion / ICP-AES	TJA IRIS INTREPID II	(e) 200.3 / 200.7
Copper	Acid Digestion / ICP-AES	TJA IRIS INTREPID II	(e) 200.3 / 200.7
Iron	Acid Digestion / ICP-AES	TJA IRIS INTREPID II	(e) 200.3 / 200.7
Lead	Acid Digestion / ICP-AES	TJA IRIS INTREPID II	(e) 200.3 / 200.7
Manganese	Acid Digestion / ICP-AES	TJA IRIS INTREPID II	(e) 200.3 / 200.7
Mercury	Thermal / AA	Milestone DMA80	(e) 7473
Mercury	Cold Vapor Generation / AF	Leeman PS Hydra Gold	(w) 1631E
Nickel	Acid Digestion / ICP-AES	TJA IRIS INTREPID II	(e) 200.3 / 200.7
Selenium	Hydride Generation / AA	TJA Solaar M6	(c) 7742
Silver	Acid Digestion / ICP-AES	TJA IRIS INTREPID II	(e) 200.3 / 200.7
Thallium	Acid Digestion / ICP-AES	TJA IRIS INTREPID II	(e) 200.3 / 200.7
Tin	Acid Digestion / ICP-AES	TJA IRIS INTREPID II	(e) 200.3 / 200.7
Zinc	Acid Digestion / ICP-AES	TJA IRIS INTREPID II	(e) 200.3 / 200.7

FISH TISSUE: Liver, Muscle, and Whole (Organics)

Analyte	Description	Instrumentation	Reference <sup>1</sup>
Base/Neutral Extractables	Basic / CH <sub>2</sub> Cl <sub>2</sub> ASE extraction, GC-MSD	Dionex ASE-200 Agilent-7890GC/5975 MSD Capillary DB-5625	(c) 3545 / 8270 C
Chlorinated Pesticides	CH <sub>2</sub> Cl <sub>2</sub> extraction, GC-ECD/MS/MS	Varian 3800 GC Saturn 2000 MS-Ion Trap DB-XLB/60m	(c) 3545 / 8081 A
PCBs	CH <sub>2</sub> Cl <sub>2</sub> extraction, hexane exchange, GC-ECD/MS/MS	Varian 3800 GC Saturn 2000 MS-Ion Trap DB-XLB/60m	(c) 3545 / 8082

<sup>1</sup> Reference listing is found following this listing of analytical methods.



Method References: Methods of Analysis Used to Produce the Data Presented in this Report.

- a) Methods for Chemical Analysis of Water and Wastes, EPA, Environmental Monitoring and Support Laboratory, Cincinnati, Ohio, March 1979 (EPA-600/4-79-020), 1983 Revision, and March 1984 (EPA-600/4-84-017).
- b) U.S. EPA Contract Laboratory Program, Statement of Work for Organic Analysis, Multi-Media, Multi-Concentration, 7/85 revision and 1/91 revision.
- c) Test Methods for Evaluating Solid Waste, Physical/Chemical Methods, U.S. EPA Office of Solid Waste and emergency Response, Washington, D.C. 20460, November 1986, SW-846, Third Edition. Revision 0 September 1994, December 1996, Revision 2
- d) The Determination of Inorganic Anions in Water by Ion Chromatography, Revision 2.1, August 1993
- e) The Determination of Metals and Trace Elements in Water and Waste Revision 4.4, EMMC Version, EMMC Methods Work Group, 1994
- f) Standard Methods for the Examination of Water and Wastewater, APHA, AWWA, WPCF, 17th Edition, 1989.
- g) Standard Methods for the Examination of Water and Wastewater, APHA, AWWA, WPCF, 18th Edition, 1992.
- h) Standard Methods for the Examination of Water and Wastewater, APHA, AWWA, WPCF, 19th Edition, 1995.
- i) Standard Methods for the Examination of Water and Wastewater, APHA, AWWA, WPCF, 20th Edition, 1998.
- j) Criteria for Identification of Hazardous and Extremely Hazardous Wastes, California Code of Regulations (CCR), Title 22.
- k) DIONEX AU 107, R.D.Rocklin and E.L.Johnson, ANAL. CHEM., 1986, 55, 4
- l) Adaptation of method by the Naval Ocean Systems Center, San Diego, Marine Environment Branch, San Diego, CA 92152-5000
- m) "TOC/TN in Marine Sediments...", SCCWRP Annual Report, 1990-1991, and 1991-1992.
- n) "A Guide to Freeze Drying for the Laboratory...", LABCONCO, 3-53-5/94-Rosse-5M-R3, 1994.
- o) "Lipids Content in Fish Tissues via Accelerated Solvent Extraction...", WWChem, EMTS/MWWD, 1998
- v) Procedures for Handling and Chemical Analysis of Sediment and Water Samples, Russel H. Plumb, Jr., May 1981, EPA/Corp of Engineers Technical Committee on Criteria for Dredged and Fill Material, EPA Contract 4805572010.

C. Frequency of Analysis and Type of Sample - 2013

1. Definitions.

D= Daily      W= Weekly      M= Monthly      Q= Quarterly      S= Semi-Annual

Constituent	Type of Sample	FREQUENCY OF ANALYSIS			
		Influent	Effluent	Comb_Effluent	Reclaim
<b>Permit Required Testing</b>					
Flow	Recorder/Totalizer	<i>Continuous</i>	<i>Continuous</i>		<i>Continuous</i>
Biochemical Oxygen Demand - Total (5-day)	24hr Composite	<i>D</i>	<i>D</i>	<i>Q</i>	<i>D</i>
Oil and Grease	Grab		<i>W</i>	<i>Q</i>	
pH	Grab		<i>D</i>	<i>Q</i>	<i>D</i>
Settleable Solids	Grab		<i>W</i>	<i>Q</i>	
Temperature			<i>W</i>	<i>Q</i>	
Total Suspended Solids	24hr Composite	<i>D</i>	<i>D</i>	<i>Q</i>	<i>D</i>
Volatile Suspended Solids	24hr Composite				<i>D</i>
Total Dissolved Solids	24hr Composite				<i>M</i>
Turbidity	24hr Composite		<i>W</i>	<i>Q</i>	<i>W</i>
Dissolved Oxygen	Grab		<i>W</i>	<i>Q</i>	
Total Residual Chlorine	Grab		<i>W</i>	<i>Q</i>	
As,Cd,Cr,Cu,Pb,Hg,Ni,Ag,Zn	24hr Composite	<i>M</i>	<i>M</i>	<i>Q</i>	
Sb, Be, Tl	24hr Composite		<i>M</i>	<i>Q</i>	
Se	24hr Composite		<i>M</i>	<i>Q</i>	
Fe, Mn, B					<i>M</i>
Anions (Chloride, Sulfate, Nitrate as N, Fluoride)	24hr Composite				<i>M</i>
Ammonia-Nitrogen	24hr Composite		<i>M</i>	<i>Q</i>	
MBAS	24hr Composite				<i>M</i>
Cyanide	24hr Composite	<i>M</i>	<i>M</i>	<i>Q</i>	
Acrolein and Acrylonitrile	Grab		<i>Q</i>	<i>Q</i>	
Base/Neutral Compounds	24hr Composite		<i>Q</i>	<i>Q</i>	
Benzidines	24hr Composite		<i>Q</i>	<i>Q</i>	
Dioxin	24hr Composite		<i>M</i>	<i>Q</i>	
Percent Sodium	24hr Composite				<i>M</i>
Pesticides, chlorinated	24hr Composite		<i>M</i>	<i>Q</i>	
Phenols, non-chlorinated	24hr Composite		<i>M</i>	<i>Q</i>	
Phenols, chlorinated	24hr Composite		<i>M</i>	<i>Q</i>	
Polychlorinated Biphenyls	24hr Composite		<i>Q</i>	<i>Q</i>	
Purgeable (Volatile) Compounds	Grab		<i>Q</i>	<i>Q</i>	
Tri, Di, & monobutyl tins	24hr Composite		<i>Q</i>	<i>Q</i>	
Radiation	24hr Composite		<i>M</i>	<i>Q</i>	
Toxicity (Acute & Chronic)*	24hr Composite		<i>W</i>	<i>Q</i>	

\*Reported monthly in the *Toxicity Testing Report* by the Biology Section.

D= Daily      W= Weekly      M= Monthly      Q= Quarterly      S= Semi-Annual

Constituent	Type of Sample	FREQUENCY OF ANALYSIS			
		Influent	Effluent	Comb_Effluent	Reclaim
<b>Additional Testing</b>					
Total Dissolved Solids	24hr Composite	<i>D</i>			
Volatile Suspended Solids	24hr Composite	<i>D</i>			
Pesticides, organophosphorus	24hr Composite	<i>S</i>	<i>S</i>	<i>S</i>	<i>S</i>
Cations (Ca <sup>2+</sup> , Mg <sup>2+</sup> , Li <sup>+</sup> , Na <sup>+</sup> , K <sup>+</sup> )	24hr Composite	<i>M</i>	<i>M</i>	<i>Q</i>	<i>M</i>
Anions	24hr Composite	<i>M</i>	<i>M</i>	<i>Q</i>	
Fe	24hr Composite	<i>M</i>	<i>M</i>	<i>Q</i>	
Oil and Grease	Grab	<i>Q</i>			<i>Q</i>
pH	Grab	<i>D</i>			
Settleable Solids	Grab	<i>Q</i>			
MBAS	24hr Composite	<i>Q</i>	<i>Q</i>	<i>Q</i>	
Turbidity	24hr Composite	<i>Q</i>			<i>Continuos</i>
Sb, Be, Tl	24hr Composite	<i>M</i>			<i>M</i>
Se	24hr Composite	<i>M</i>			<i>M</i>
Ammonia-Nitrogen	24hr Composite	<i>Q</i>			<i>Q</i>
Cyanide	24hr Composite				<i>Q</i>
Acrolein and Acrylonitrile	Grab	<i>Q</i>			<i>Q</i>
Base/Neutral Compounds	24hr Composite	<i>Q</i>			<i>Q</i>
Benzidines	24hr Composite	<i>Q</i>			<i>Q</i>
Dioxin	24hr Composite	<i>M</i>			<i>Q</i>
Pesticides, chlorinated	24hr Composite	<i>Q</i>			<i>Q</i>
Phenols, non-chlorinated	24hr Composite	<i>Q</i>			<i>Q</i>
Phenols, chlorinated	24hr Composite	<i>Q</i>			<i>Q</i>
Polychlorinated Biphenyls	24hr Composite	<i>Q</i>			<i>Q</i>
Tri, Di, & monobutyl tins	24hr Composite	<i>Q</i>			<i>Q</i>
Percent Sodium	24hr Composite		<i>M</i>	<i>Q</i>	
Purgeable (Volatile) Compounds	Grab	<i>Q</i>			<i>Q</i>
Radiation	24hr Composite	<i>M</i>			<i>Q</i>

D. Laboratories Contributing Results used in this report.

- i) Metropolitan Wastewater Chemistry Laboratory  
(EPA Lab Code: CA00380, ELAP Certificate: 1609)  
5530 Kiowa Drive  
La Mesa, CA 91942  
(619)668-3212  
*All results except those listed below.*
- ii) Point Loma Wastewater Chemistry Laboratory  
(EPA Lab Code: CA01435, ELAP Certificate: 2474)  
1902 Gatchell Road  
San Diego, CA 92106  
(619)221-8765  
*Process control analyses and wet methods for the plant.*
- iii) North City Wastewater Chemistry Laboratory  
(EPA Lab Code: CA01436, ELAP Certificate: 2477)  
4949 Eastgate Mall  
San Diego, CA 92121  
(858)824-6009  
*Process control analyses and wet methods for the plant.*
- iv) Metro Biosolids Center Chemistry Laboratory  
(EPA Lab Code: CA01437, ELAP Certificate: 2478)  
5240 Convoy Street  
San Diego, CA 92111  
(858)614-5834  
*Process control analyses and wet methods for the plant.*
- v) South Bay Water Reclamation Plant  
(EPA Lab Code: CA01460, ELAP Certificate: 2539)  
2411 Dairy Mart Road  
San Diego, CA 92173  
619.428.7349  
*Process control analyses and wet methods for the plant.*
- vi) City of San Diego - Water Quality Laboratory  
(EPA Lab Code: CA00080, ELAP Certificate: 1058)  
5530 Kiowa Drive  
La Mesa, CA 91942  
(619)668-3237  
*Total Organic Carbon in Wastewater*
- vii) City of San Diego - Marine Microbiology and Vector Management  
(EPA LabCode: CA01393, ELAP Certificate: 2185)  
4918 Harbor Drive, Suite 101  
San Diego, CA 92106  
(619) 758-2311  
*Microbiology*
- viii) City of San Diego – Toxicity Bioassay Laboratory  
(EPA Lab Code: CA01302, ELAP Certificate: 1989 )  
4918 Harbor Drive, Suite 101  
San Diego, CA 92106  
(619) 758-2347  
*Bioassays*
- ix) Frontier Analytical Laboratory  
5172 Hillside Circle  
El Dorado Hills, CA 95762  
ELAP Certification: 02113CA  
Telephone# (916) 934-0900  
*Dioxins/Furans*
- x) Test America  
2800 George Washington Way  
Richland, WA 99354-1613  
CA ELAP Certification: 2425  
Telephone# (509) 375-3131  
*Gross Alpha/Beta Radioactivity*

## **Summary and Overview:**

The Wastewater Chemistry Services Section, Metropolitan Wastewater Department, City of San Diego performs most of the NPDES and other permit and process control chemical and physical testing for the City of San Diego E.W. Bloom, Pt. Loma Wastewater Treatment Plant (PLWWTP), North City Water Reclamation Plant (NCWRP), South Bay Water Reclamation Plant (SBWRP), and the Metro Biosolids Center (MBC). We also perform the chemical/physical testing of ocean sediment and fish tissue samples for the Ocean monitoring program for the City of San Diego (PLWWTP Ocean Outfall and SBWRP Ocean Outfall) and the International Boundary and Water Commission, International Treatment Plant outfall. We also perform environmental testing for various customers, both internal to the City of San Diego and for other agencies.

The QA/QC activities of the Laboratory are comprehensive and extensive. Of the 35,042 samples received in the Laboratory in 2013, approximately 24.6% were Quality Control (QC) samples, such as blanks, check samples, standard reference materials, etc. 113 different analyses were performed throughout the year resulting in 262,628 analytical determinations. Of the determinations, 105,857 (~40.0%) were QC determinations (e.g. blanks, lab. replicates, matrix spikes, surrogates, etc.) used to determine the accuracy, precision, and performance of each analysis and batch.

We have 5 separate laboratory facility locations, each with its own California ELAP (Environmental Laboratory Accreditation Program) certification for the fields of testing required under California regulations. This is a rigorous program involving continuing independent blind performance testing, biannual comprehensive audits, and extensive documentation requirements. Each of the 5 laboratory facilities in the Metropolitan Wastewater (Metro) Department are independently certified and copies of those certifications are included at Attachment 1. California ELAP certifies fields of testing (methods/analytes) only for Water, Wastewater, and Hazardous materials for which methods are published in the Federal Register or specifically approved in regulation by U.S.EPA. Additionally, the Laboratory performs analyses using methods for which certification does not exist, such as ocean sediment and sea water determinations. Those methods have been developed in-house, derived from or in collaboration with other scientific laboratories (e.g. Scripps Institute of Oceanography, Southern California Coastal Water Research Project, et. al.) and have been used extensively in multi-agency EPA and State sponsored studies over the past several years. Many methods of analysis developed for matrices and applications not within ELAP jurisdiction have been adapted from ELAP listed methods. In all cases, we apply generally accepted standards of performance and quality control to methods.

Additionally, the operating division and all Metro Department Laboratories maintained International Standards Organization (ISO) 14001 Environmental Management Systems certification.

Contract laboratories are also required to use only approved methods for which they hold certification for, and/or are approved by the appropriate regulatory agency (e.g. SDRWQCB). Copies of their certifications are included as Attachment 2.

The following report summarizes the QA/QC activities during 2013 and documents the laboratory information and certifications for those laboratories which provided data used in NPDES and other permit monitoring or environmental testing during the year.

**Laboratories Contributing Results used in this report.**

Laboratory Name	EPA Lab Code	ELAP Cert.#	Address	Phone #	Contribution
Alvarado Wastewater Chemistry Laboratory	CA00380	1609	5530 Kiowa Drive L Mesa, CA 91942	(619)668-3212	All results except those listed below.
Pt. Loma Wastewater Chemistry Laboratory	CA01435	2474	1902 Gatchell Road San Diego, CA 92106	(619)221-8765	Process Control Analyses and wet mehtod for the treatment plant.
North City Wastewater Chemistry Laboratory	CA01436	2477	4949 Eastgate Mall San Diego, CA 92121	(858)824-6009	Process Control Analyses and wet mehtod for the treatment plant.
Metro Biosolids Center Chemistry Laboratory	CA01437	2478	5240 Convoy Street San Diego, CA 92111	(858)614-5834	Process Control Analyses and wet mehtod for the treatment plant.
South Bay Wastewater Chemistry Laboratory	CA00080	2539	2411 Dairy Mart Road San Diego, CA 92173	(619)428-7349	Process Control Analyses and wet mehtod for the treatment plant.
City of San Diego Water Quality Laboratory	CA01393	1058	5530 Kiowa Drive La Mesa, CA 91942	(619)668-3237	Total Organic Carbon in Wastewater
City of San Diego- Marine Microbiology	CA01302	2185	2392 Kincaid Road San Diego, CA 92101	(619)758-2312	Microbiology
City of San Diego Toxicology Laboratory		1989	2392 Kincaid Road San Diego, CA 92101	(619)758-2341	Bioassays
TestAmerica Laboratories, Inc		2425	2800 George Washington Way, Richland, WA 99354	(509)375-3131	Gross Alpha/Beta Radioactivity
TestAmerica Nashville Division		01168CA	2960 Foster Creighton Drive Nashville, TN 37204	(615)756-0177	Herbicides
Frontier Analytical Laboratory		02113CA	5172 Hillsdale Circle El Dorado Hills, CA 95762	(916)934-0900	Dioxin/Furan Wastewater and Solids

## **Facilities & Scope:**

The Wastewater Chemistry Services Section (WCS) comprises five geographically separated laboratories. The Section's main laboratory facilities and headquarters located at the Alvarado Joint Laboratory building in La Mesa and the four satellite wastewater chemistry laboratories located at MWW treatment plants maintain individual California Department of Health Service, Environmental Laboratory Accreditation Program (ELAP) certification in their respective Fields of Testing (FoT). Each laboratory has its own U.S.EPA Lab Code as shown in the following table.

Laboratory Facility	Laboratory	Address	Phone	EPA Lab. Code	ELAP Cert. No.
<b>Alvarado Laboratory</b>	<b>Wastewater Chemistry Laboratory</b>	<b>5530 Kiowa Drive, La Mesa CA 91942</b>	<b>619.668.3215</b>	<b>CA00380</b>	<b>1609</b>
<b>Point Loma Satellite Lab</b>	<b>Pt. Loma Wastewater Chemistry Laboratory</b>	<b>1902 Gatchell Rd., San Diego, CA 92106</b>	<b>619.221.8765</b>	<b>CA01435</b>	<b>2474</b>
<b>North City Water Reclamation Plant Satellite Lab</b>	<b>North City Wastewater Chemistry Laboratory</b>	<b>4949 Eastgate Mall, San Diego, CA 92121</b>	<b>858.824.6009</b>	<b>CA01436</b>	<b>2477</b>
<b>Metro Biosolids Center Satellite Lab</b>	<b>Metro Biosolids Center Wastewater Chemistry Lab</b>	<b>5240 Convoy Street, San Diego, CA 92111</b>	<b>858.614.5834</b>	<b>CA01437</b>	<b>2478</b>
<b>South Bay Water Reclamation Plant Satellite Lab</b>	<b>South Bay Wastewater Chemistry Laboratory</b>	<b>2411 Dairy Mart Rd., San Diego CA 92154</b>	<b>619.428.7349</b>	<b>CA01460</b>	<b>2539</b>

The information presented in this report applies to the Wastewater Chemistry Services Section, including all of the laboratories listed above, unless specified otherwise. The main laboratory at Alvarado is the main office for the WCS and contains the most extensive laboratory facilities of the several laboratories. Along with a variety of process control and wet chemistry analyses, this facility also handles all of the trace metals, pesticides/organics determinations, and other analyses. The satellite laboratories are primarily dedicated to process control, wet chemistry, and other analyses directly related to the support of the operations of the co-located wastewater treatment plant.

The Wastewater Chemistry Services Section performs most of the NPDES and other permit and process control chemical and physical testing for the:

- E.W. Blom, Pt. Loma Wastewater Treatment Plant (PLWWTP), NPDES Permit No. CA0107409/ Order No. R9-2009-0001, including the ocean monitoring program.
- North City Water Reclamation Plant (NCWRP), Order No. 97-03.
- Metro Biosolids Center (MBC), no permit, but monitoring requirements contained in Permit No. R9-2009-0001.
- South Bay Water Reclamation Plant (SBWRP), NPDES Permit No. CA0109045/ Order No. 2013-0006.
- Ocean monitoring program for the International Boundary and Water Commission, International Treatment Plant.
- Other environmental testing for various customers, both internal to the City of San Diego and other public agencies.

A small portion of the required monitoring testing was sub-contracted out to laboratories certified by ELAP for those analyses, specifically;

- Gross alpha- and Beta radiations are analyzed by Test America Laboratories, Inc., Richland Division
- Herbicides are analyzed by Test America Laboratories, Inc, Nashville Division
- Total organic carbon (TOC) in water are analyzed by the Water Quality Laboratory, City of San Diego, Water Department.
- Dioxin and Furans in solids and wastewater are analyzed by Frontier Analytical Laboratory.

Copies of these laboratories' ELAP certifications are included as Attachment 2. The City of San Diego pays for additional QC samples (replicates, blanks, and spikes) as a routine quality check on contracted laboratory work. This is beyond the usual and customary practices with contract laboratory work.

#### Ocean monitoring:

While there are no recognized State certifications for laboratory analyses of marine environmental samples (e.g. seawater, sediments, various tissues, etc.), the City of San Diego has been a leader in the development and standardization of analytical methods for determinations in these areas.

Many of the methods are novel approaches developed after extensive research and development from other published work (e.g. organo-tin analyses, sediment grain size, etc.) or adaptations of existing EPA methods (e.g. SW 846 Method 8082 for PCB congeners in sediments, etc.). In all of these cases we participate in extensive inter-laboratory calibration studies. Some of the most extensive studies have involved the participation of several public, academic/research, and private laboratories under the umbrella of the Southern California Coastal Water Research Project (SCCWRP). These programs are repeated periodically as part of the Southern California Bight Regional Monitoring/Survey Project. This is a massive sampling and monitoring program participated in by all of the major Publicly Owned Treatment Works (POTWs), California Water Resource Control Boards, and research organizations.

Our laboratory is a reference (referee) laboratory for the NRCC (National Research Council of Canada) CARP-2 Certified Reference Material (CRM) for fish tissue. This was adopted as the standard reference material for QC QA for the Southern California Bight Regional Project. This sample is also used world-wide as a standard reference material. We have worked with NIST to develop a West Coast marine sediment and fish tissue standard reference material (SRM).

---



**QA/QC Activities Summary:**

**Report for January 1, 2013 - December 31, 2013.<sup>7</sup>**

The sample distribution for 2013 is not significantly changed from 2011. **269,029** analytical determinations were made on **35,042** samples received by the Laboratory in 2012(see table A.). Of these **8,576** or **24.47%** were Quality Control (QC) samples. **13.29%** were blanks and **10.52%** check or reference samples.

	2013	2013
	Number of Samples	Percent of total samples
<b>Table A. Samples</b>		
Customer/Environmental samples	26,428	75.42%
Quality Contr ol (QC) samples	8,614	24.58%
<b>Total Samples</b>	<b>35,042</b>	<b>100.00%</b>

**QC Samples:**

**Blanks:**

FIELD_BLANK	215	0.61%
REAGENT_BLANK	18	0.05%
TRIP BLANK	0	0.00%
METHOD_BLANK	4,657	13.29%
<b>Total Blanks:</b>	<b>4,890</b>	<b>13.95%</b>

**Check samples:**

External Check samples	2,084	5.95%
Internal Check samples	1,569	4.48%
SRMs (Standard Reference Material)	33	0.09%
<b>Total Check Samples:</b>	<b>3,686</b>	<b>10.52%</b>
<b>Total QC Samples:</b>	<b>8,576</b>	<b>24.47%</b>

High levels of QC are used for laboratory determinations. **40.3%** of the **262,628** determinations were QC (e.g. blanks, lab replicates, matrix spikes, surrogates, etc.). If calculated for the **260,980** customer determinations only, the percentage increases to **44.0%**.

0.64% of total analytical determinations or of analytical batches did not meet internal QA review due to a variety of criteria, e.g. unsuccessful calibration, unacceptable QC performance, etc. Samples having analytical determinations that were rejected are reanalyzed, or, if that is not possible, the data is either not reported or reported but flagged as having not met data quality objectives and may not be suitable for compliance determination.

<sup>7</sup> Data counts (metrics) were obtained on March 21, 2013 and do not include analyses that were underway, but incomplete as of that time. All table data is based on samples collected between January 1, 2012 and December 31, 2012. This data summary is comprehensive; includes all laboratory analyses work for all customers, projects, and programs unless otherwise indicated.

**Table A.2. Analyses (results) - 2013**

	<b>Number</b>	<b>Percent of total</b>
<b>Total number of analytes/results determined:</b>	262,628	NA
Total results not complete <sup>2</sup> :	17,008	6.5%
<b>No. of results for Customer/ Environmental Samples <sup>1,3</sup>:</b>	240,514	91.6%
Total number of rejected results:	22,114	8.96%
No. of results for blanks <sup>3</sup> :	25,884	9.9%
No. of results for matrix spikes <sup>3</sup> :	16,705	6.4%
No. of results for Check samples <sup>3</sup> :	26,087	9.9%
No. of results for Replicates <sup>3</sup> :	25,422	9.7%
No. of results for surrogates <sup>3</sup> :	11,759	4.5%
<b>Total QC analyses run <sup>3</sup> :</b>	<b>105,857</b>	<b>40.3%</b>
<b>Total in-house analyses completed <sup>2</sup>:</b>	<b>246,911</b>	

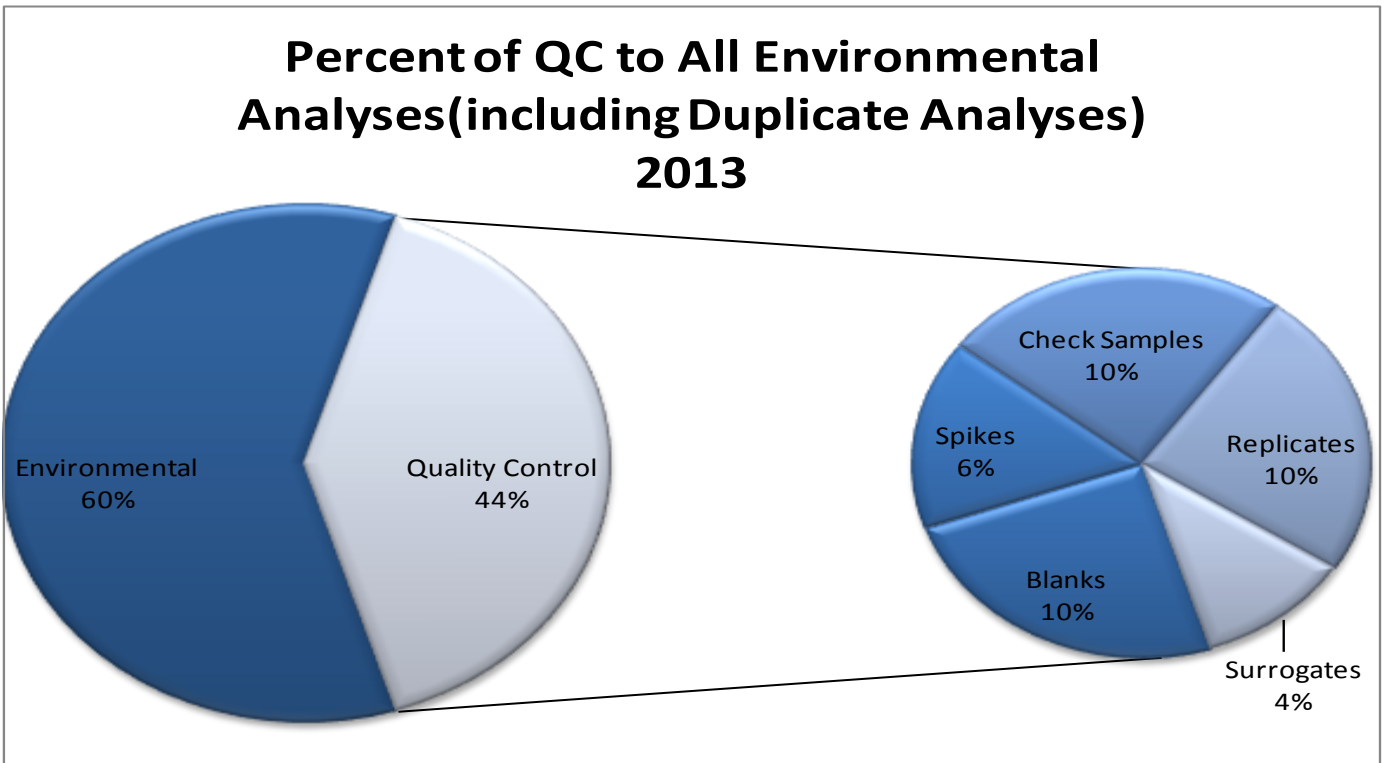

1 – matrix spike, replicates, surrogates are also part of the total for Customer/Environmental samples.

2 – as of March 6, 2014.

3 – percent of QC samples calculated from grand total of **262,628**.

NOTE: Analysis, for the purposes of the metrics used in this report generally refer to each analyte determined in each sample in a batch. For example, an analysis (determination) of several metals in a sample (e.g. iron, nickel, lead) would total as 3 analyses in the expression of totals such as those in the Analyses table on the preceding page. This method of calculation has been used for many years and, with batch and method, is useful comparative measure of laboratory performance and is one of the fundamental constants in applying quality control measures.

	<b>No. of Batches</b>	<b>Percent of total</b>
Total number of analytical batches:	<b>15,402</b>	
Total number of rejected analytical batches:	<b>98</b>	<b>0.64%</b>
Incomplete batches (as of March 21, 2013):	<b>149</b>	<b>0.97%</b>

### **Outside laboratories**

A small number of permit required analyses are contracted out, including gross alpha- & Beta- radiation, and Total Organic Carbon in wastewater as summarized below. Herbicides analysis contracted to Test America Laboratory.

Results from sub-contracted labs.		
Laboratory	Analytes	% of Total in-house Analytes
Test America	394	0.16%
Frontier Laboratory	4,590	1.86%
Water Quality, City of San Diego	140	0.06%
<b>Total outside results:</b>	<b>5,124</b>	<b>2.08%</b>

**QA Plan:**

The Quality Assurance Plan was updated in March 2013.

---

**Performance Testing (PT) Studies for 2013:**

The Wastewater Chemistry Laboratories participates in required ELAP and U.S.EPA PT studies throughout the year. We participated in 13 PT studies in 2013. Each of our geographically separated laboratory facilities participated individually (as required by ELAP). PT studies were purchased from Wibby and Phenova and were successfully completed. When results submitted were determined to be outside of study acceptance limits the laboratory reviewed internal protocols, modified procedures were necessary and participated in a subsequent study for the analytes in question. A PT study was completed with satisfactory results for all analytes by in-house chemistry laboratories.

The results of the Laboratory PT studies for 2013 are summarized in the following tables.

---

**Alvarado Wastewater Chemistry Laboratory:**

<b>PT Study</b>	<b>Number of Analytes</b>	<b>Number of Acceptable results</b>	<b>Success Rate (%)</b>
HW-0113	20	20	100%
HW-0413	90	90	100%
HW-0513	1	1	100%
HW-0713	47	47	100%
HW-1013	4	4	100%
RP-11471	1	1	100%
SOIL- 82	2	2	100%
WP-0213	8	8	100%
WP-0313	73	73	100%
WP-0413	51	47	92.2%
WP-0713	32	32	100%
WP-1113	19	19	100%
<b>Total analytes:</b>	<b>348</b>	<b>344</b>	<b>Overall: 98.9%</b>

**North City Chemistry Laboratory:**

<b>PT Study</b>	<b>Number of Analytes</b>	<b>Number of Acceptable results</b>	<b>Success Rate (%)</b>
WP-0513	2	2	100%
WP-0413	14	14	100%
<b>Total analytes:</b>	<b>16</b>	<b>Overall:</b>	<b>100%</b>

**Metro Biosolids Center (MBC) Chemistry Laboratory:**

<b>PT Study</b>	<b>Number of Analytes</b>	<b>Number of Acceptable results</b>	<b>Success Rate (%)</b>
WP-0413	5	5	100%
<b>Total analytes:</b>	<b>5</b>	<b>Overall:</b>	<b>100%</b>

***Pt. Loma Wastewater Chemistry Laboratory:***

---

<b>PT Study</b>	<b>Number of Analytes</b>	<b>Number of Acceptable results</b>	<b>Success Rate (%)</b>
WP-0413	6	6	100%
WP-0513	7	7	100%
<b>Total analytes:</b>	13	<b>Overall:</b>	100%

---

***South Bay Wastewater Chemistry Laboratory:***

---

<b>PT Study</b>	<b>Number of Analytes</b>	<b>Number of Acceptable results</b>	<b>Success Rate (%)</b>
WP-0213	15	15	100%
WP-0219	1	1	100%
WP-0413	1	1	100%
<b>Total analytes:</b>	17	<b>Overall</b>	100%

---

## E. Staff Contributing to this Report

Staff Contributing to this Report in 2013

Initials	ID	First Name	Last Name	Signature
BOA	BOA	Ben	Andoh	
TB	TSB	Tan	Bao	
VB	VEB	Virginia	Basilan	
EB	BTX	Enrique	Blanco	
BGB	N8B	Brent	Bowman	
LC	UEC	Laura	Carr	
JC	G3C	Jose	Castro	
JCM	U8C	Jacqueline	Cazares-Medina	
NC	NLC	Nancy	Coglan	
SC	SCORIA	Salvador	Coria	
MC	M5C	Maricela	Coronel	
JCM	G8C	Jerry	Czajkowski	
KD	KOD	Ken	Dang	
BD	BDONAHUE	Brad	Donahue	
SD	SDRAPER	Sara	Draper	
HH	HZD	Heather	Duckett	
ACD	AD4	Angelica	Duran	
JTF	JRF	Jeff	Findley	
EFITZ	EFITZGERALD	Erica	Fitzgerald	
KG	KG3	Kenneth	Genz	
MH	MHANNA	Mona	Hanna	
RJ	RCJ	Ron	Jardine	
WLJ	WLJOHNSON	Wendy	Johnson	
LK	LNK	Lee	King	
VK	VK4	Vesselka	Kozarev	
EL	EVL	Estela	Lanez	
LL	Lli	Lin	Li	
AM	M5U	Armando	Martinez	
FM	YBM	Fernando	Martinez	
CGM	M4M	Connie	Mata	
JM	G7M	Jeff	McAnally	
JN	IEN	Jesus	Nieto	
MN	MGZ	Maria	Noller	
LP	LJP	Lorena	Pantoja	
PP	PPARRA	Paola	Parra	
LP	LXP	Leonard	Przybylo	
CAQ	CQ5	Corinna	Quinata	
KR	KRV	Keith	Ruehrwein	
RS	NDS	Robert	Sandoval	
VS	VS7	Victoria	Santibanez	
DWS	DXS	David	Schlickman	
GS	GTS	Greg	Schlimme	
GLS	HIR	Gloria	Siqueiros	
MRS	MWS	Michael	Stewart	
MIS	S49	Margot	Szeterlak	
SV	SCV	Sandra	Valenzuela	
ZV	ZVANSLAGER	Zachary	Vanslager	
JW	AIW	Julie	Webb	
KLW	N/A	Kristof	Witczak	

Figure 1. Chemistry Laboratory Organization Chart.

Metropolitan Wastewater Department  
 Environmental Monitoring and Technical Services Division  
**Wastewater Chemistry Laboratory**

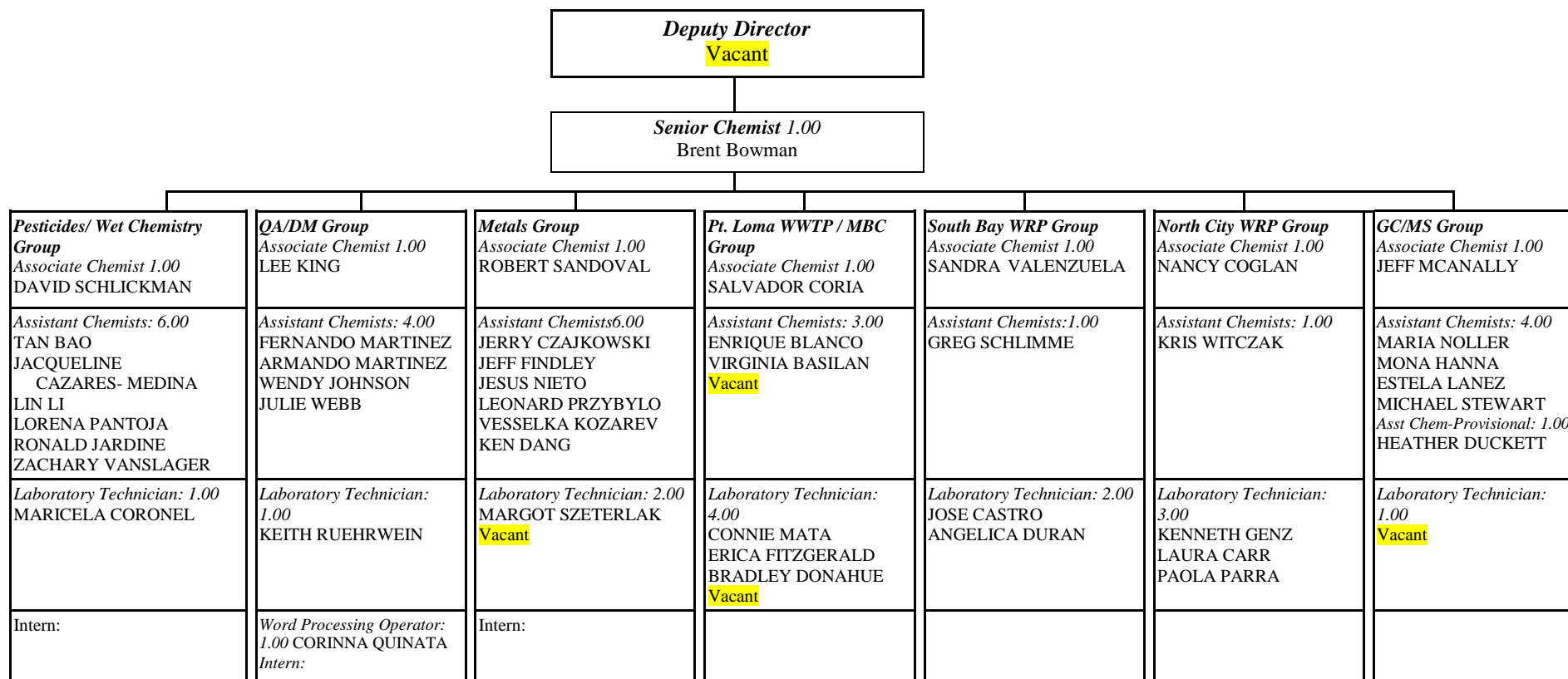



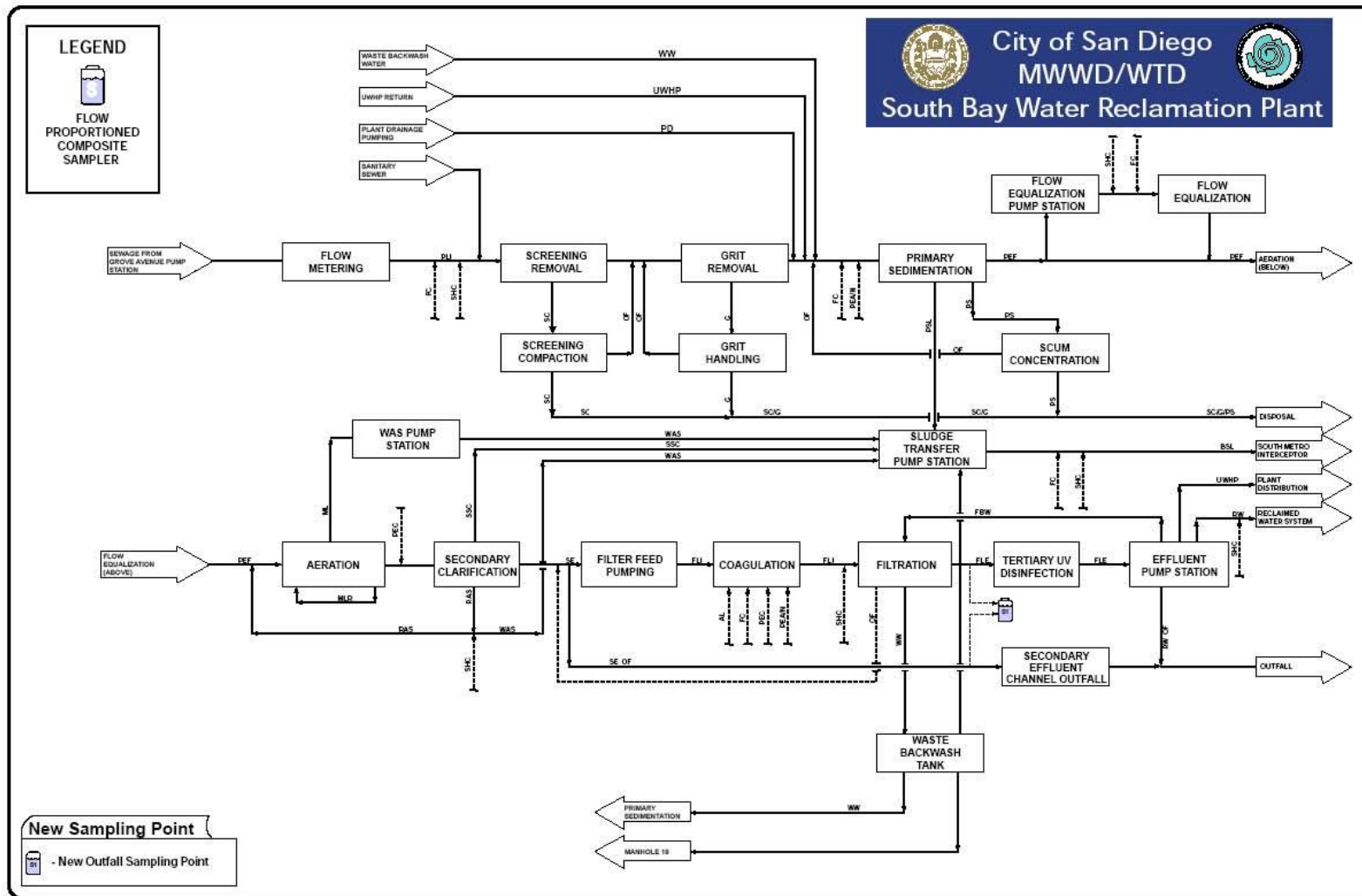

Figure 1 - New Effluent to Ocean Outfall Sample Point

South Bay Water Reclamation Plant  
Effluent to Ocean Outfall Sampling System  
June 2007

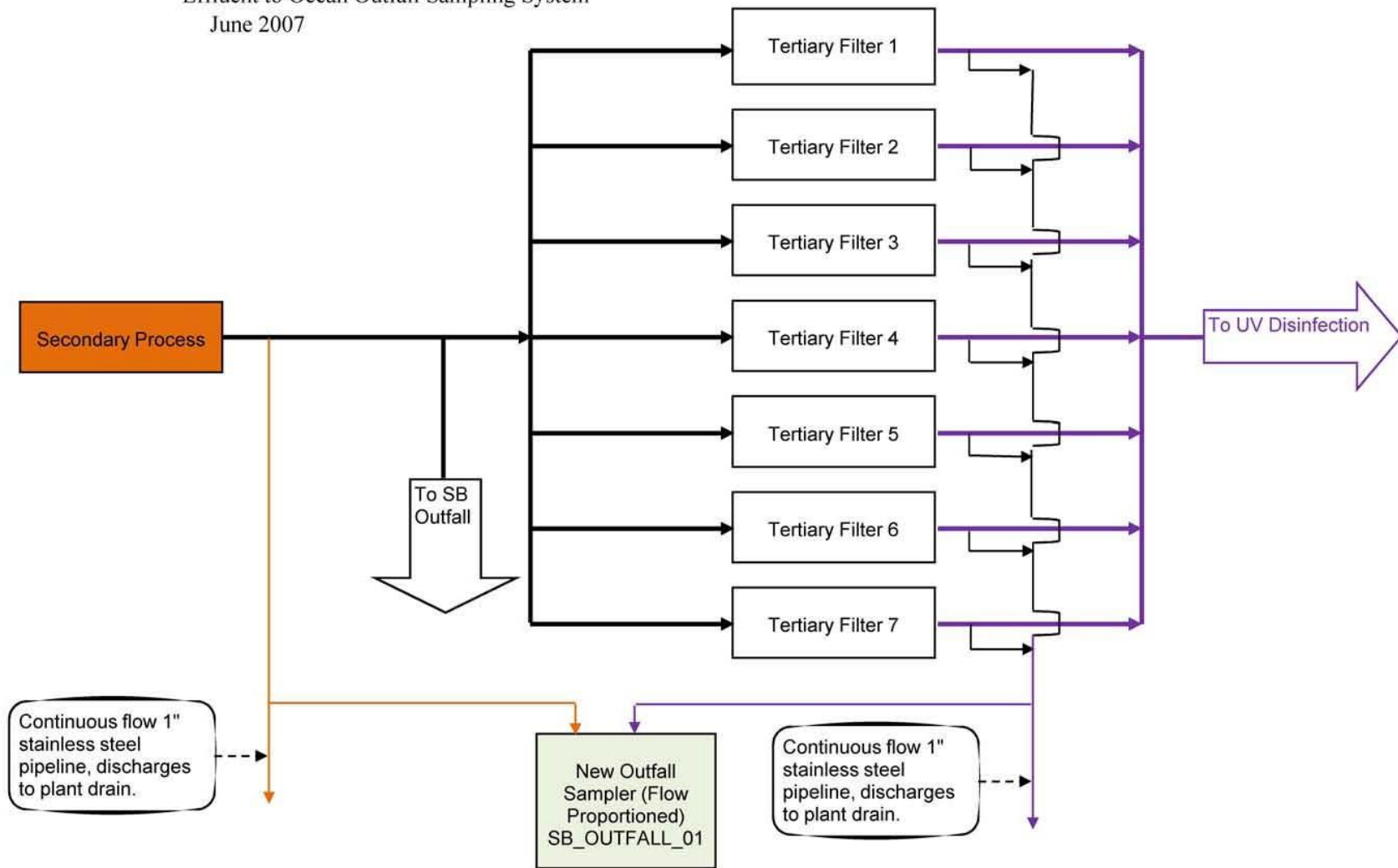

Figure 2 - Detail of Effluent Sampling System