



THE CITY OF SAN DIEGO

REPORT TO THE PLANNING COMMISSION

DATE ISSUED: June 16, 2011 **REPORT NO. PC-11-041**

ATTENTION: Planning Commission, Agenda of June 23, 2011

SUBJECT: ARCO Balboa Avenue – Project No. 163653. Process 5

**OWNER/
APPLICANT:** Seven Clairemont Properties/
BP West Coast Products (Attachment 13)

SUMMARY

Issue: Should the Planning Commission recommend the City Council approve a request to rezone a property, and to demolish and rebuild a new vehicle service station and convenience store with continuing alcohol sales at 6130 Balboa Avenue in the Clairemont Mesa Community Plan area?

Staff Recommendation:

1. Recommend that the City Council Certify Negative Declaration No. 163653; and
2. Recommend that the City Council Adopt Rezone No. 837802, and Approve Conditional Use Permit No. 586793, Site Development Permit No. 586794, Planned Development Permit No. 840713, and Neighborhood Use Permit No. 623983, Amending Conditional Use Permit No. 83-0729.

Community Planning Group Recommendation: On January 11, 2011, the Clairemont Community Planning Group voted 11-0-0 to recommend approval of the project on the condition that the landscaping in the planters/boxes along Mt. Abernathy include a minimum of medium-sized trees and not just shrubs.

Environmental Review: Negative Declaration No. 163653 has been prepared for this project in accordance to the California Environmental Quality Act (CEQA) State CEQA guidelines.

Fiscal Impact Statement: All costs associated with the processing of this project are paid for through a deposit account maintained by the applicant.

Code Enforcement Impact: None.

Housing Impact Statement: The project site is being rezoned from CN-1-2 to CC-1-3, however the site has been used as a vehicle service station since first being approved in 1966. The proposed project has no impact on housing.

BACKGROUND

The project site at 6130 Balboa Avenue is located at the northeast corner of Balboa Avenue and Mount Abernathy Street (Attachments 1 and 2). The site is located within the Clairemont Mesa Community Plan which identifies the site as “Community Core” and within the Community Plan Implementation Overlay Zone (Attachment 3).

City records show that the site was first developed as a service station in 1966 under Permit No. C-7731 when the site was zoned C1-A. In 1981 under Conditional Use Permit (CUP) No. 10-625-0, a mini-market was added to the facility, while the site was zoned CN. On January 5, 1984, while still zoned CN, the CUP was amended to allow a new gasoline sales pump island and canopy while also recognizing the 24-hour operation (Attachment 4). The proposed project will amend and supersede all these prior permits.

DISCUSSION

Project Description:

The proposed ARCO Balboa Avenue project located at 6130 Balboa Avenue would rezone the site from CN-1-2 to CC-1-3, demolish an existing gas station with convenience store, and construct a new vehicle service station with a 2,400 square foot convenience store and 3,400 square foot canopy with six (6) fuel dispensers on the 0.42 acre site (Attachment 6). In addition the project would allow for the continued alcohol sales (Type 20: Off-Premise Beer and Wine only), and 24-hour operation.

Community Plan Analysis:

The proposed project is in conformance with the commercial designation of the Clairemont Mesa Community Plan. The Plan designates this site as a portion of the Community Core and places it in the Community Plan Implementation Overlay Zone, Type B, recommending that a Planned Development Permit be obtained. Further, the proposed project would implement the Balboa Avenue Revitalization Action Program (RAP) by enhancing the aesthetics of the site and providing improved landscaping and pedestrian amenities. Specific project features include: a outdoor patio area, direct pedestrian access from the sidewalk to the building, the closure and consolidation of several driveways, and the installation of street trees with tree grates. These features are intended to help promote walkability along Balboa Avenue and establish pedestrian and bicycle connections to the adjacent residential neighborhoods.

Environmental Analysis:

A Negative Declaration has been prepared for this project in accordance to the California Environmental Quality Act (CEQA) (Attachment 7). During the review of this project Staff evaluated hazardous materials and determined that the projects impacts would be below significance.

Project-Related Issues:

The proposed project constitutes a continuation of a long standing use of the property. With the Municipal Code update in 2000, the CN-1-2 zone no longer allows Vehicle Service Stations with either a Conditional or Neighborhood Use Permit. Therefore complete demolition of the previously conforming use requires the applicant to obtain numerous approvals as discussed below:

Rezone

The majority of the “Community Core” properties within the Clairemont Mesa Community Implementation Overlay Zone (CPIOZ) are zoned CC-1-3. This includes properties to the South and the large Genesse Plaza and Balboa Mesa shopping centers to the west. While this site is adjacent to multi-family units zoned RM-3-7, the service station use has been in existence for over forty (40) years, and this rezone from CN-1-2 to CC-1-3 is consistent with the intent of the past entitlements and allowed uses (Attachment 8).

Conditional Use Permit

The existing service station and convenience store has been operating on a 24-hour basis since at least 1984, and selling beer and wine under a Type 20 –Off Premise (beer and wine only) Alcoholic Beverage Control (ABC) License for many years under various ABC licenses. The continued sale of these products requires a Conditional Use Permit. The San Diego Police Department has requested that the pay phone on the premises be removed. The pay phone has been responsible for 16 of the 26 calls for service in January-October 2010, with all being 911 hang-ups (Attachment 12). A condition has been added to the draft permit eliminating the pay phone (Attachment 9). In addition the Police Department has stated that in this census tract (85.07) there are four (4) existing ABC Licenses where five (5) are permitted.

Site Development Permit

The project site at 6130 Balboa Avenue is identified in the Municipal Code as being located in the CPIOZ-Area B within the Clairemont Mesa Community Plan. The Municipal Code Section 132.1402 and Table 132-14B requires a Site Development Permit for development in this area.

Planned Development Permit

The project site is located within the commercial designation of the Clairemont Mesa Community Plan. The Plan designates this site as a portion of the Community Core and places it

in the Community Plan Implementation Overlay Zone, Type B, recommending that a Planned Development Permit be obtained. The proposed project does not deviate from any development regulations of the CC-1-3 zone.

Neighborhood Use Permit

The CC-1-3 zone allows vehicle service stations with a Neighborhood Use Permit. The conditions of approval for the project will require compliance with several operational constraints and development controls intended to assure the continued protection of public health, safety, and welfare (Attachment 9). The development will also provide for the health, safety, and welfare of the customers and nearby residents by constructing all buildings in accordance with current construction standards and building codes. All of the construction plans associated with the project will be reviewed prior to issuance of a construction permit and inspected during construction to assure the project will meet or exceed all relevant and applicable building, electrical, mechanical, plumbing and fire codes.

Community Planning Group Recommendation

On January 11, 2011, the Clairemont Community Planning Group voted 11-0-0 to recommend approval of the project on the condition that the landscaping in the planters/boxes along Mt. Abernathy include a minimum of medium-sized trees and not just shrubs (Attachment 11).

The proposed planting plan for the project has incorporated this request with three Jacarandas to be added in the planter located along Mount Abernathy. The construction documents will be reviewed against this exhibit prior to issuance of the construction permits.

Conclusion:

Staff have reviewed the proposed Rezone, Conditional Use Permit, Site Development Permit, Planned Development Permit and Neighborhood Use Permit, amending and superseding the previous permits, and has found it to be in conformance with the requirements of the Municipal Code. Staff believes the required findings can be supported and recommends the Planning Commission recommend approval of this project to the City Council.

ALTERNATIVES:

1. Recommend that the City Council Adopt Rezone No. 837802, and Approve Conditional Use Permit No. 586793, Site Development Permit No. 586794, Planned Development Permit No. 840713, and Neighborhood Use Permit No. 623983, Amending Conditional Use Permit No. 83-0729, **with modifications.**
2. Recommend that the City Council Deny Rezone No. 837802, and Deny Conditional Use Permit No. 586793, Site Development Permit No. 586794, Planned Development Permit No. 840713, and Neighborhood Use Permit No. 623983.

Respectfully submitted,



Mike Westlake
Program Manager
Development Services Department



Project Manager
Development Services Department

WESTLAKE/JT

Attachments:

1. Aerial Photograph
2. Project Location Map
3. Community Plan Land Use Map
4. Existing Conditional Use Permit No. 83-0729
5. Project Data Sheet
6. Site Plans
7. Environmental Resolution
8. Rezone B-Sheet and Draft Ordinance
9. Draft Permit with Conditions
10. Draft Permit Resolution with Findings
11. Community Planning Group Recommendation
12. Police Calls for Service
13. Ownership Disclosure
14. Chronology



Aerial Photo

ARCO BALBOA AVENUE – 6130 BALBOA AVENUE
PROJECT NO. 163653

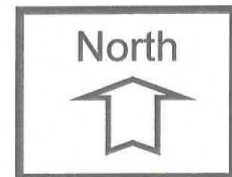

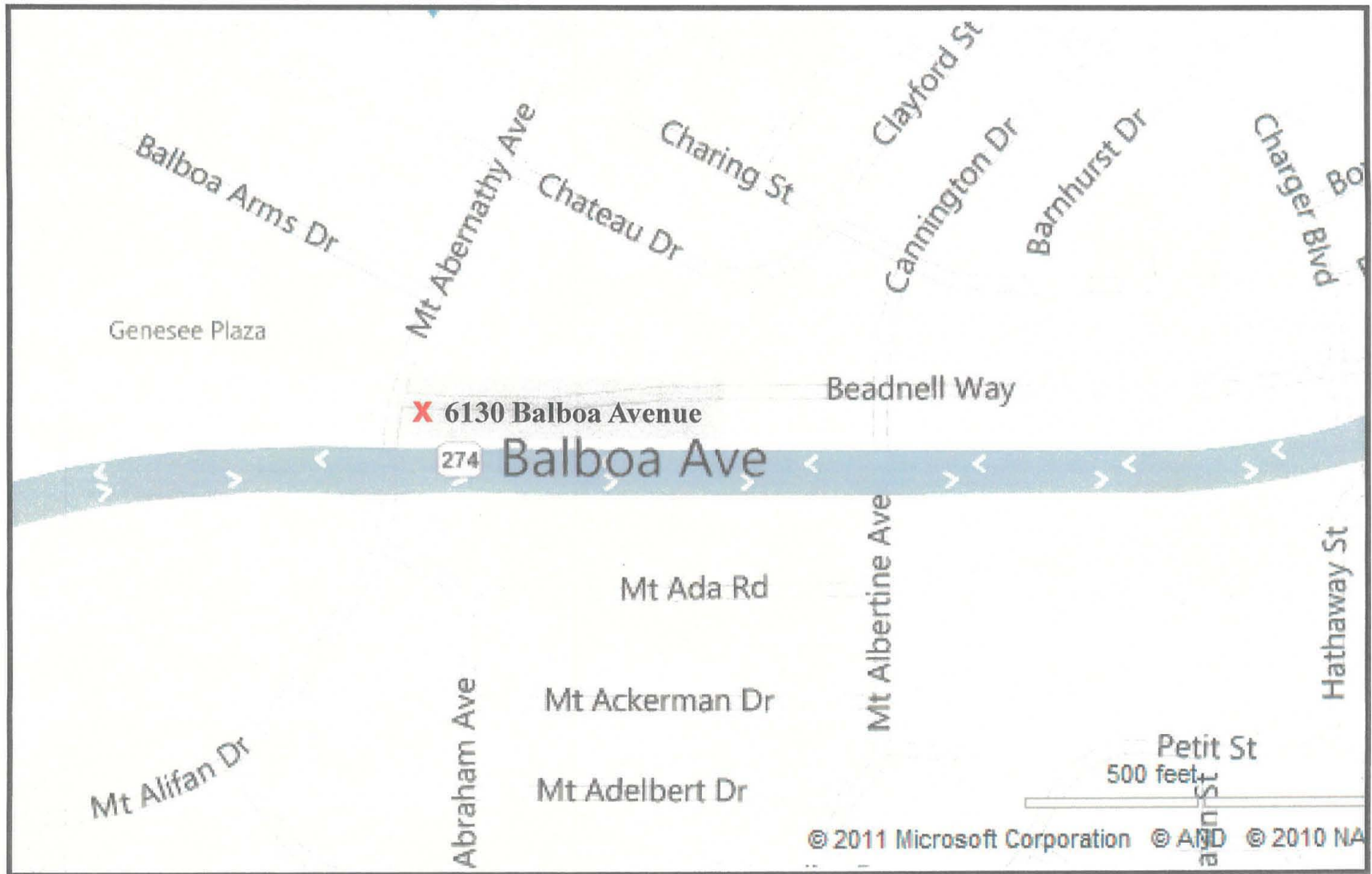

Project Location Map

ARCO BALBOA AVENUE – 6130 BALBOA AVENUE
 PROJECT NO. 163653

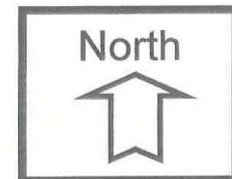

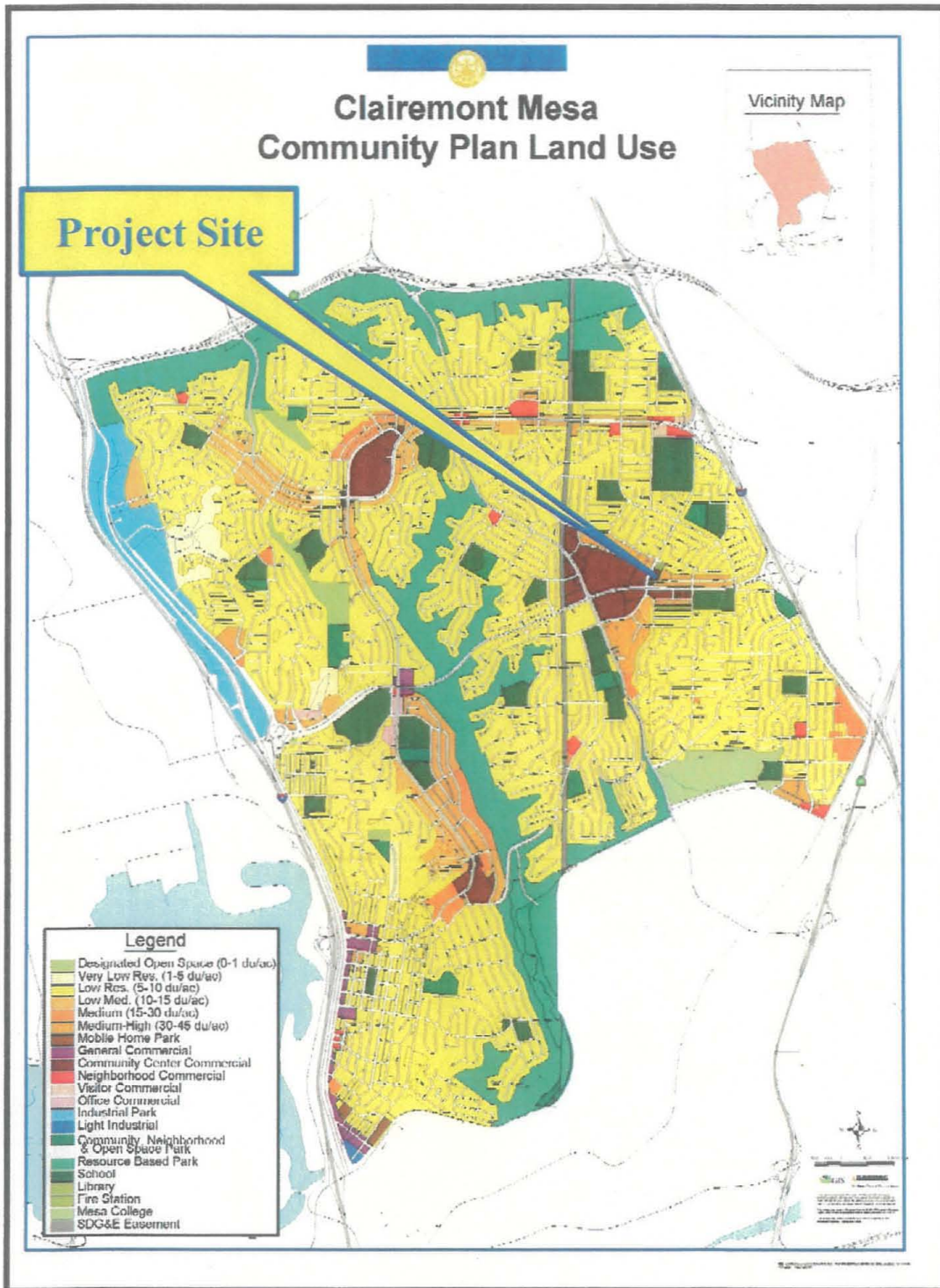

Land Use Map

ARCO BALBOA AVENUE – 6130 BALBOA AVENUE
PROJECT NO. 163653



CONDITIONAL USE PERMIT NO. 83-0729

APR 09 1984

PLANNING COMMISSION

ZONING ADMINISTRATION

This conditional use permit amendment is granted by the Planning Commission of The City of San Diego to ATLANTIC RICHFIELD COMPANY, a Pennsylvania corporation, Lessee, Owner/Permittee, under the conditions in Section 101.0506 of the Municipal Code of The City of San Diego.

1. Permission is granted to Owner/Permittee to construct and operate a second self-service pump island and canopy addition to a self-service gasoline sales facility and mini-market, located at the northeast corner of Balboa Avenue and Mount Abernathy Avenue, described as Lot 3, Balboa Annex Unit No. 2, Map No. 5119, in the CN zone.
2. The facility shall consist of the following:
 - a. Existing self-service gasoline sales and mini-market;
 - b. New self-service gasoline sales pump island and canopy;
 - c. Off-street parking;
 - d. Accessory uses as may be determined incidental and approved by the Planning Director.
3. No fewer than six off-street parking spaces shall be maintained on the property in the approximate location shown on Exhibit "A," dated January 5, 1984, on file in the office of the Planning Department. Parking spaces shall be consistent with Division 8 of the Municipal Code and shall be permanently maintained and not converted for any other use. Parking spaces and aisles shall conform to Planning Department standards. Parking areas shall be marked.
4. A self-service gasoline sales facility and mini-market may be operated on a 24-hour basis.
5. Pennants or banners shall not be permitted on the premises.
6. Signaling devices to alert station attendants to entering vehicles shall be located and adjusted to minimize noise disturbances to adjoining properties.
7. No merchandise or supplies shall be stored or displayed outdoors, except that motor oil may be stored on suitable racks on pump islands.
8. All trash shall be stored in suitable containers, and the containers shall be placed within the building or within enclosed solid walls or fences.

CUP No. 83-0729 (Am. to CUP No. 10-625-0)

9. A letter from the Lessee, stating that he has read and understands the conditions imposed on the service station, shall be written, signed and sent to the parent oil company, and a copy sent to The City of San Diego Planning Department.

10. A copy of this conditional use permit shall be posted on the premises of the service station at all times and be available for viewing by any person or persons who may desire to see the document.

11. In the event that the gasoline sales service facility is abandoned or vacated for a continuous period of one year (12 months), the property owner shall cause to have all structures, buildings, signs and accessory uses related to the gasoline service station and other potentially hazardous conditions removed from the premises. Underground fuel storage tanks shall also be removed or capped, satisfactory to the Fire Department.

12. No construction or operation of any facility shall be granted, nor shall any activity authorized by this permit be conducted on the premises until:

- a. The Owner/Permittee signs and returns the permit to the Planning Department; and
- b. The conditional use permit is recorded in the office of the County Recorder.

13. Before issuance of any building permits, complete building plans shall be submitted to the Planning Director for approval. Plans shall be in substantial conformity to Exhibit "A," dated January 5, 1984, on file in the office of the Planning Department. No change, modifications or alterations shall be made unless appropriate applications for amendment of this permit shall have been granted.

14. Before issuance of any building permits, a revised landscape plan, with additional landscaping along Beadness Way, as shown on Exhibit "A," including a permanent irrigation system, shall be submitted to the Planning Director for approval. Approved planting shall be installed before issuance of any occupancy permit on any building. Such planting shall not be modified or altered unless this permit has been amended.

15. All outdoor lighting shall be so shaded and adjusted that the light is directed to fall only on the same premises as light sources are located.

16. This conditional use permit amendment must be used within 18 months after the date of City approval or the permit shall be void. An extension of time may be granted, as set forth in Section 101.0506 and 101.0507 of the Municipal Code.

17. Construction and operation of the approved use shall comply at all times with the regulations of this or any other governmental agencies.

18. After establishment of the project, the property shall not be used for any other purposes unless:

- a. Authorized by the Planning Commission; and
- b. The proposed use meets every requirement of the zone existing for the property at the time of conversion; or
- c. The permit has been revoked by the City.

19. This conditional use permit may be revoked by the City if there is a material breach or default in any of the conditions of this permit. This includes the limitation on permitted signage.

20. This conditional use permit is a covenant running with the lands and shall be binding upon the Owner/Permittee and any successor or successors, and the interests of any successor shall be subject to each and every condition set out.

21. Sign identification shall consist of existing building wall-mounted signs, an existing monument price sign and proposed canopy-mounted signs.

22. This project shall be reviewed for conformance six months from the date of approval.

PASSED AND ADOPTED BY THE PLANNING COMMISSION OF THE CITY OF SAN DIEGO
ON JANUARY 5, 1984.

PROJECT DATA SHEET

ATTACHMENT 5

PROJECT NAME:	ARCO Balboa Avenue
PROJECT DESCRIPTION:	Continue to operate an alcoholic beverage outlet, and to demolish an existing gas station and construct a new gas station with a 2,400 square foot convenience store and 3,400 square foot canopy with six (6) fuel dispensers
COMMUNITY PLAN AREA:	Clairemont Mesa
DISCRETIONARY ACTIONS:	Rezone/CUP/SDP/PDP/NUP
COMMUNITY PLAN LAND USE DESIGNATION:	General Commercial/Community Core

ZONING INFORMATION:

ZONE: To be rezoned CC-1-3

HEIGHT LIMIT: 30-Foot maximum height limit.

LOT SIZE: 5,000 square-foot minimum lot size.

FLOOR AREA RATIO: 0.75 maximum.

FRONT SETBACK: 0 feet.

SIDE SETBACK: 10 feet.

STREETSIDE SETBACK: 0 feet

REAR SETBACK: 10 feet.

PARKING: 11 parking spaces required for development

<u>ADJACENT PROPERTIES:</u>	LAND USE DESIGNATION & ZONE	EXISTING LAND USE
NORTH:	Community Center Commercial/RS-1-7	Fire Station
SOUTH:	Community Center Commercial/CC-1-3	Gas Station/Strip Mall
EAST:	Med-High Density/RM-3-7	Apartments
WEST:	Community Center Commercial/CC-1-3	Genesee Plaza Shopping Center

DEVIATIONS OR VARIANCES REQUESTED:	None
---	------

COMMUNITY PLANNING GROUP RECOMMENDATION:	On January 11, 2011, the Clairemont Community Planning Group voted 11-0-0 to recommend approval of the project with a condition satisfied on the plans.
---	---

CONDITIONAL USE PERMIT AND SITE DEVELOPMENT PERMIT

SCOPE OF WORK:
 -RAZE AND REBUILD ENTIRE EXISTING SITE
 -ADD NEW 2400 S.F. C-STORE
 -ADD NEW 3400 S.F. GASOLINE CANOPY
 -ADD NEW UNDERGROUND STORAGE
TANKS
 -ADD NEW TRASH ENCLOSURE
 -ADD PARKING AND LANDSCAPING AREAS.
 -REZONE FROM CN-1-2 TO CC-1-3.

CONTACTS:
OWNER:
 Seven Claremont Properties
 4238 Balboa Avenue
 San Diego, CA. 92117
 PH: 626-273-4431

APPLICANT:
 AGC DESIGN CONCEPT
 204 N. FIRST AVE
 ARCADIA, CA. 91006
 PH: 626-445-0000

PROJECT ADDRESS: 6130 BALBOA AVENUE
 SAN DIEGO, CA 92111-3106
APN: 362-420-0300
ZONE: COMMUNITY PLAN IMPLEMENTATION OVERLAY # AIRPORT INFLUENCE AREA CN-1-2
EXISTING USE: 2100 S.F. CONVENIENCE MARKET WITH A GAS STATION W/ 2 MPD'S (BUILT IN 1977)
PROPOSED USE: 2400 S.F. GAS STATION W/ 6 MPD'S
SITE AREA: ± 18,408 S.F. (.42 ACRES)

MINI-MART
 ALLOWED AREA: 9,000 S.F.
 ACTUAL AREA: 2,400 S.F.
 STORIES: 1 STORY
 HEIGHT: 23'
 CONSTRUCTION TYPE: V-N
 OCCUPANCY: M / S-1
 HOURS OF OPERATION: 24 HOURS
 FLOOR RATIO: 0.13

GASOLINE
 ALLOWED AREA: 9,000 S.F.
 ACTUAL CANOPY AREA: 3,400 S.F.
 STORIES: 1 STORY
 HEIGHT: 20'
 CONSTRUCTION TYPE: V-N
 OCCUPANCY: S-3
 HOURS OF OPERATION: 24 HRS.

PARKING
 REQ'D PARKING:
 C-STORE 3 PER 1000 SF 9 + 2 SPACES
PROVIDED PARKING:
 H.C. PARKING STALL: 1 STALLS
 PARKING STD. STALL: 7 STALLS
 PARALLEL STALL: 3 STALLS
 MOTORCYCLE STALL: 2 STALLS
 TOTAL PARKING STALL: 11 AUTOMOBILE STALLS + 2 MOTORCYCLE STALLS
LANDSCAPE AREA:
 TBD S.F. REQ'D
 3,029 S.F. PROVIDED

LEGAL DESCRIPTION: LOT 3 OF BALBOA ANNEX UNIT NO. 2, IN THE CITY OF SAN DIEGO, COUNTY OF SAN DIEGO, STATE OF CALIFORNIA, ACCORDING TO MAP THEREOF NO. 5119, FILED IN THE OFFICE OF THE COUNTY RECORDER OF SAN DIEGO COUNTY, JANUARY 21, 1963.
BUILDING ADDRESS NOTE:
 PROVIDE BUILDING ADDRESS NUMBERS, VISIBLE AND LEGIBLE FROM THE STREET OR ROAD FRONTING THE PROPERTY PER FHPS POLICY P-00-6 (UFC 901.4.4)

FIRE HYDRANTS:
 NO FIRE HYDRANTS FOUND ON SITE.
BUS STOPS:
 NO BUS STOPS FOUND ON SITE

EASEMENT / SETBACKS:
 NO KNOWN SETBACKS / EASEMENTS AT STREET SIDES
LEGEND
 [Symbol] INDICATES LANDSCAPED AREAS

AGC DESIGN CONCEPT, INC.
 350 N. GLENDALES BLVD. SUITE 300
 BURBANK, CA. 91502
 Phone: 818.586.4000
 Fax: 818.586.4090
 E-Mail: ACUEVAS@AGCDCC.COM



BY	DATE	REVISIONS
ABC	01/13/10	REVISED PER PLANNING
EJ	07/22/08	REVISED PER CLIENT
EJ	07/18/08	REVISED PER CLIENT
EJ	07/16/08	REVISED PER CLIENT
ACC	16/3/08	SITE PLAN REVISION PER BP
ABC	14-1-08	CUP-1

RAZE AND REBUILD
 6130 BALBOA AVENUE
 SAN DIEGO, CA. 92111
SITE PLAN

consultant job# AGC-0014
 master release date 06/19/08
 project date 05/10/08
 master drawn by SB
 Title# AGC0014-CUP-1
 Facility/Project 01986
 sheet name CUP-1
 sheet 1 of 8

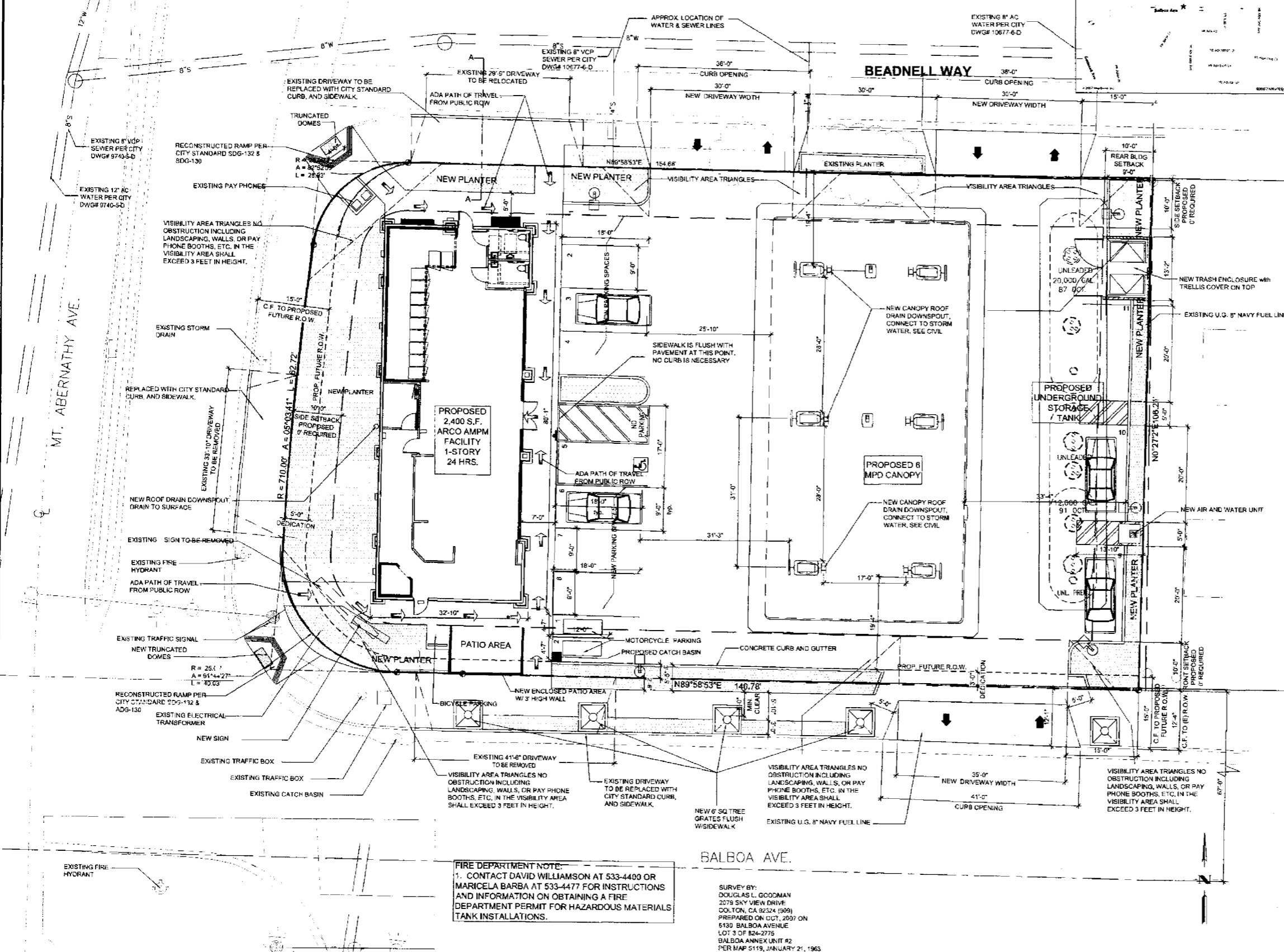
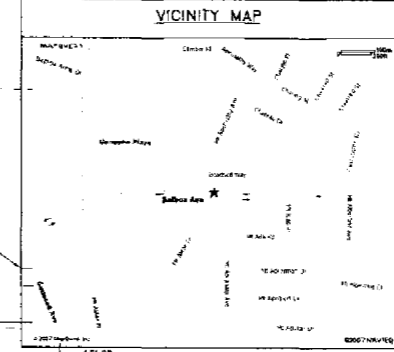
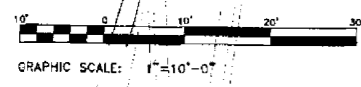

FIRE DEPARTMENT NOTE:
 1. CONTACT DAVID WILLIAMSON AT 533-4400 OR MARICELA BARBA AT 533-4477 FOR INSTRUCTIONS AND INFORMATION ON OBTAINING A FIRE DEPARTMENT PERMIT FOR HAZARDOUS MATERIALS TANK INSTALLATIONS.

SURVEY BY:
 DOUGLAS L. GOODMAN
 2378 SKY VIEW DRIVE
 COLTON, CA 92324 (909)
 PREPARED ON OCT. 2007 ON
 6130 BALBOA AVENUE
 LOT 3 OF 524-2775
 BALBOA ANNEX UNIT #2
 PER MAP 5119, JANUARY 21, 1963

CUP NO. 586793, NUP NO. 623983, PTS NO. 163653, J.O. NO. 43-1512

SOUTH WEST CORNER

ACC DESIGN CONCEPT, INC.
 350 N. GLENDALES BLVD. SUITE 307
 BURBANK, CA. 91502
 Phone: 818.566.4000
 Fax: 818.566.4090
 E-Mail: ACUEVAS@ACDC.COM

NO.	DATE	REVISIONS
1	09/03/08	REV. PER PLANNING DEPT.

RAZE AND REBUILD
 6130 BALBOA AVENUE
 SAN DIEGO, CA. 92111

consultant job#
 ACC-0014
 master release date
 06/19/08
 project
 exe date
 master drawn by
 SB
 Facility/Project
 01986
 sheet name
CUP-2
 sheet 2 of 8

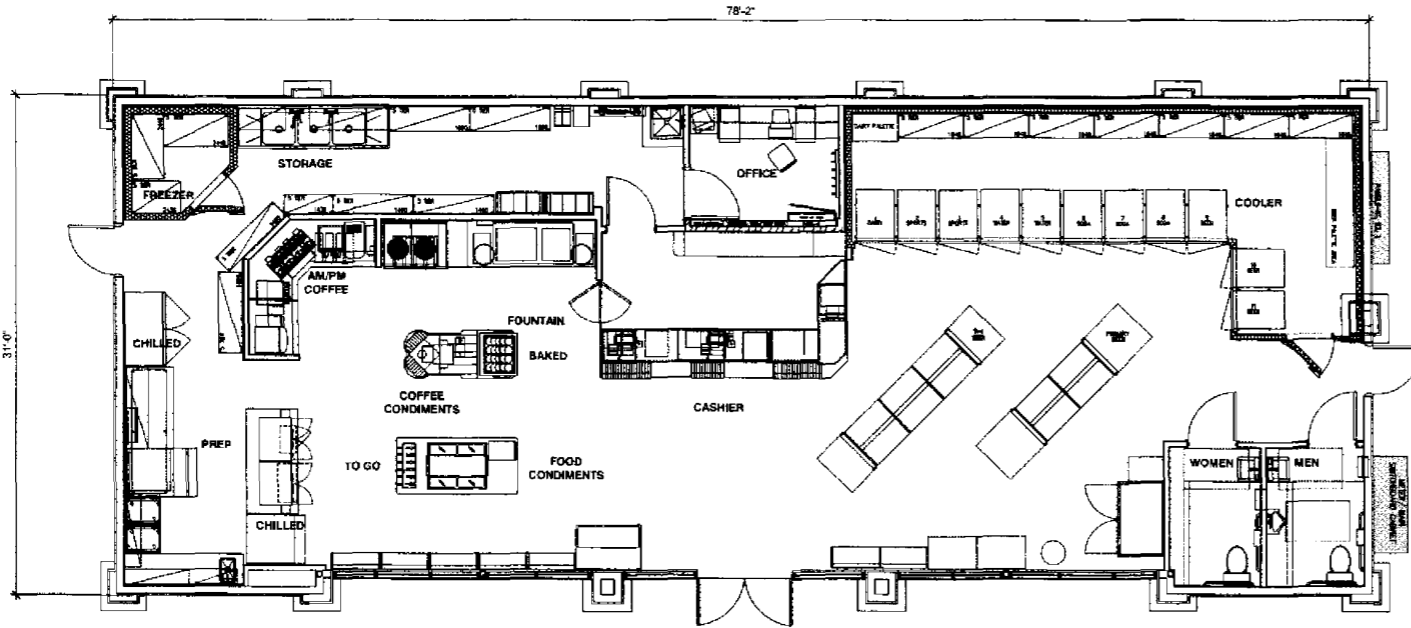

PROPOSED "ARCO AM/PM" FLOOR PLAN
 SCALE: 3/16"=1'-0"

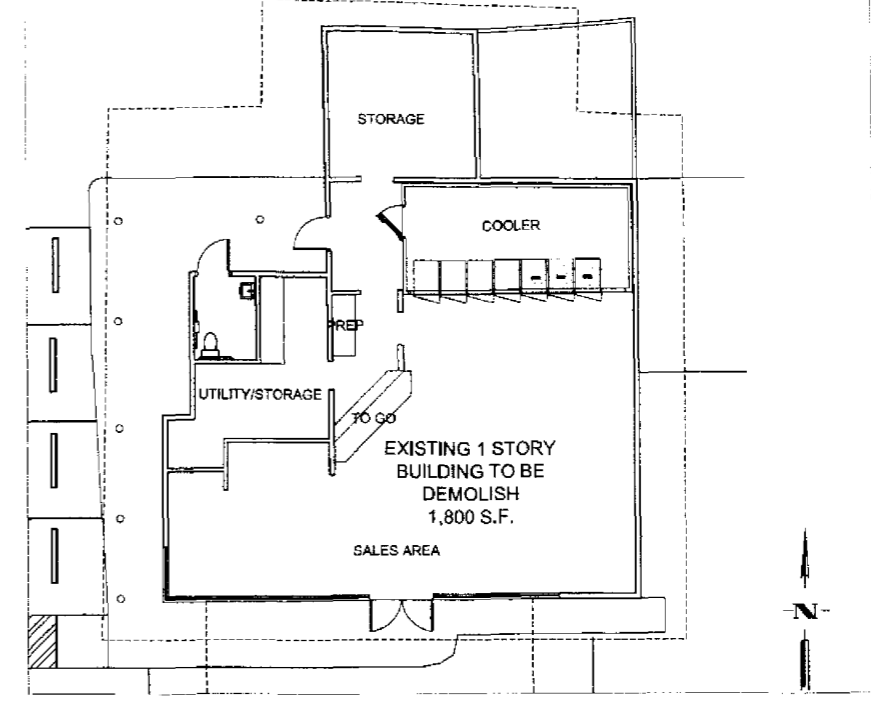

EXISTING FLOOR PLAN
 SCALE: 1/8"=1'-0"

USE	SQ.FT.
A. SALES AREA	1,238.30
B. CASHIER AREA	136.30
C. ALL OTHER	1,161.70
D. REAR AREA	37.90
TOTAL SALES AREA: 1,238.3	
TOTAL AREA: 2,400.00	

BEER AREA	NEW	EXISTING
	37.90 X 5 SHELVES 189.5 SQ.FT = 7.9 %	24.00 X 5 SHELVES 120.00 SQ.FT = 6.7 %

DECREASING PERCENTAGE - 0.8 %

USE	SQ.FT.	FACTOR	OCC. LOAD
A. SALES AREA	1238.3	30	41.28
B. BACKROOM	433	300	1.45
C. COOL FREEZER	374.1	360	1.25
D. RESTROOM	129		2.32
E. ALL OTHERS	292.3	180	2.32
TOTAL: 2,400			48.30

OCCUPANCY LOAD=47

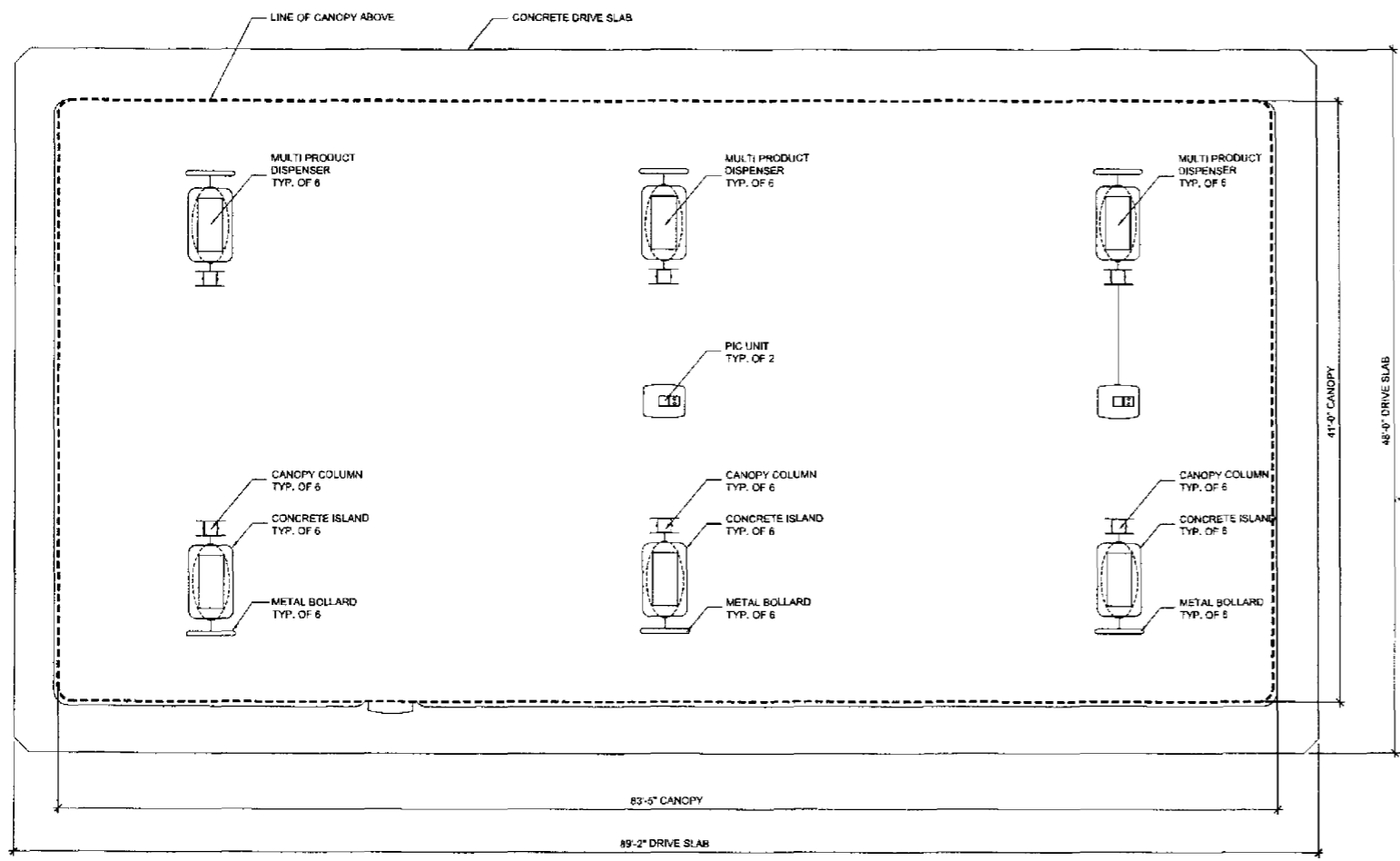

PROPOSED CANOPY FLOOR PLAN
 SCALE: 3/16"=1'-0"

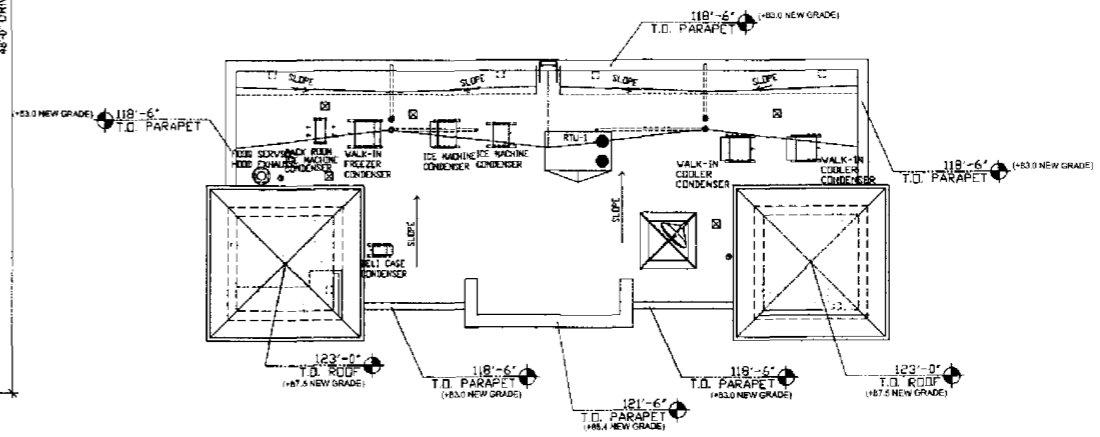

PROPOSED "ARCO AM/PM" ROOF PLAN
 SCALE: 1/8"=1'-0"

ALL ROOF MOUNTED EQUIPMENT
 WILL BE FULLY SCREENED BY
 THE PARAPETS

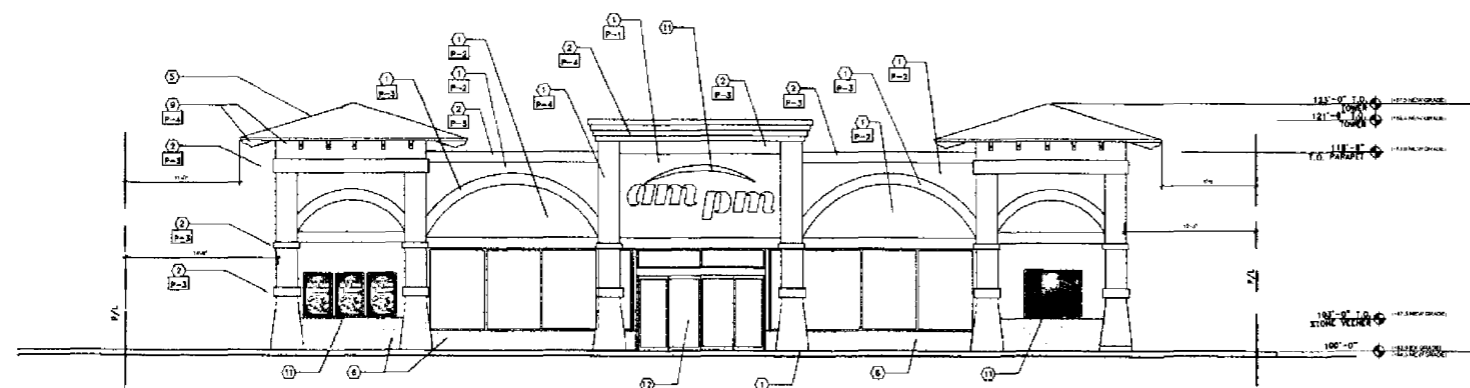

EAST ELEVATION "ARCO AM/PM"
SCALE: 1/8"=1'-0"

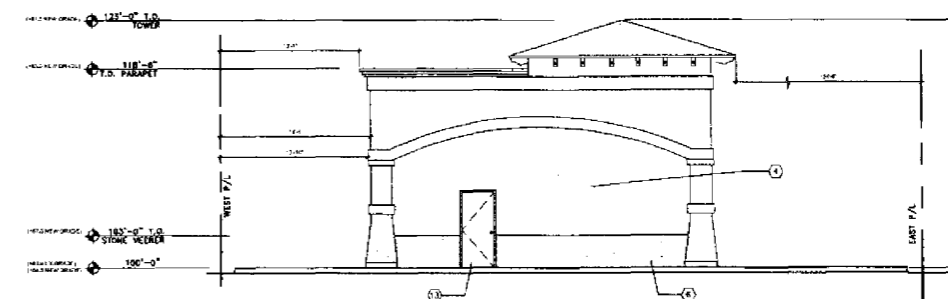

SOUTH ELEVATION "ARCO AM/PM"
SCALE: 1/8"=1'-0"

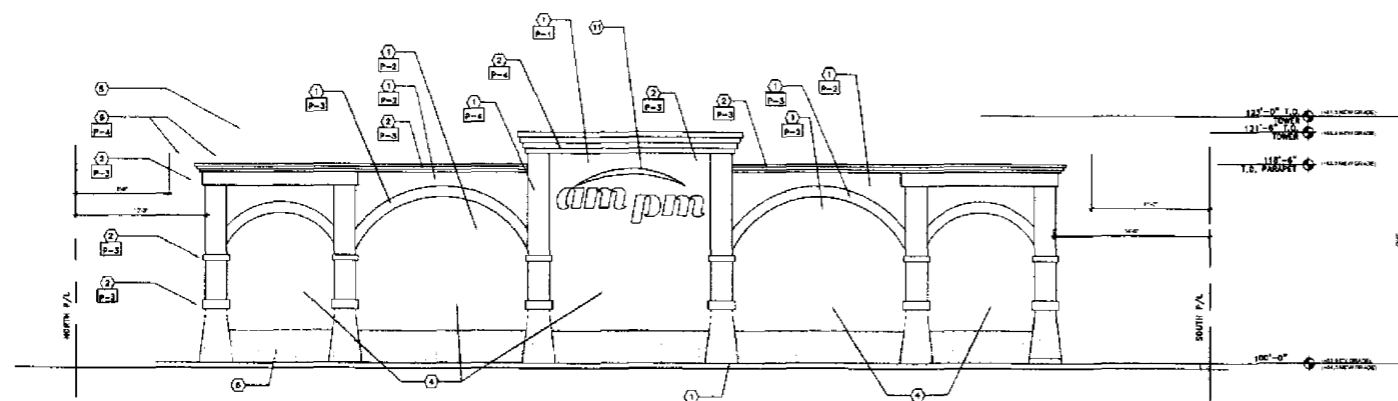

WEST ELEVATION "ARCO AM/PM"
SCALE: 1/8"=1'-0"

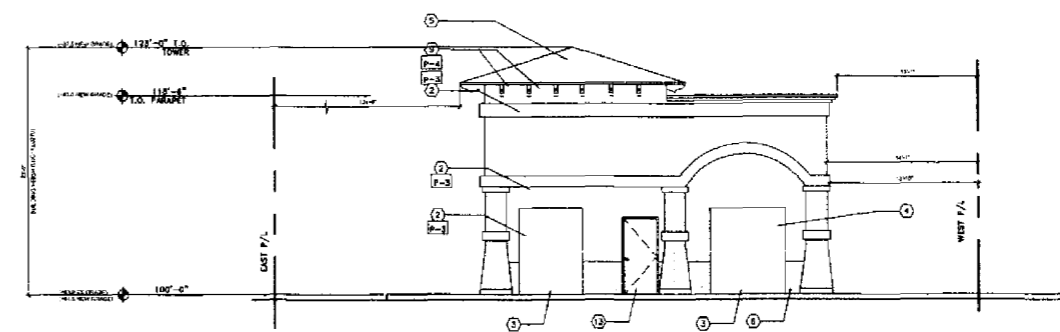

NORTH ELEVATION "ARCO AM/PM"
SCALE: 1/8"=1'-0"

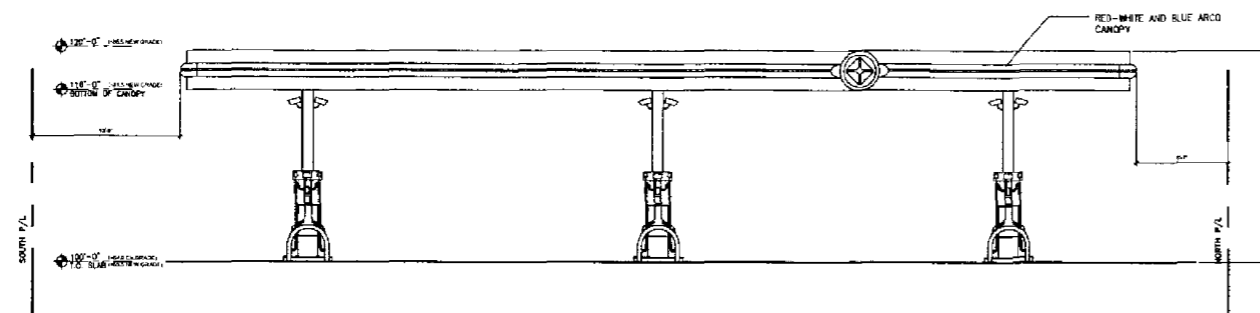

FUEL SYSTEM CANOPY
SCALE: 1/8"=1'-0"

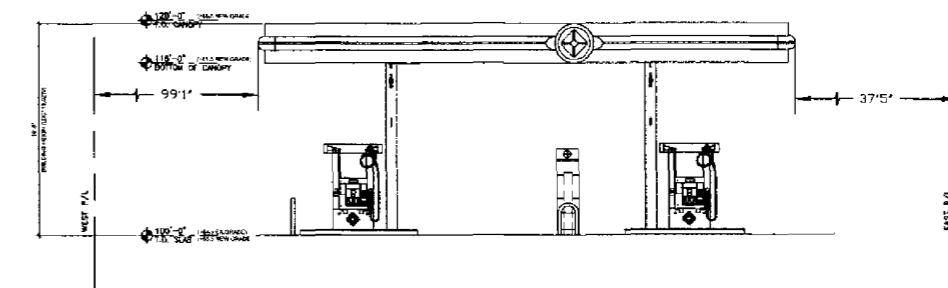

FUEL SYSTEM CANOPY
SCALE: 1/8"=1'-0"

KEYED NOTES:

- 1 STUCCO SAND FINISH
- 2 PREFAB WELDING
- 3 ELECTRICAL PANELS
- 4 WOOD TRELLIS WITH VINYL
- 5 ROOF TILE (TERRACOTA TILE)
- 6 BRICK VENEER (TERRACOTA COLOR)
- 7 ACCENT TILE, BURGANDY
- 8 WOOD RAFTERS
- 9 TRASH ENCLOSURE
- 10 SIGNAGE
- 11 DOUBLE GLASS DOOR
- 12 EMERGENCY DOOR

PAINT LEGEND

CODE	MATERIAL	MANUFACTURER	COLOR
P-1	PAINT(EXTERIOR)	DUNN-EDWARDS/ OR EQ.	ADORE SOUTH (DEC 709)
P-2	PAINT(EXTERIOR)	DUNN-EDWARDS/ OR EQ.	CUFF BROWN (DEC 711)
P-3	PAINT(EXTERIOR)	DUNN-EDWARDS/ OR EQ.	FOXTAIL (DEC 707)
P-4	PAINT(EXTERIOR)	DUNN-EDWARDS/ OR EQ.	ROSEWOOD (DEC 700)

AGC DESIGN CONCEPT, INC.
350 N. GLENDALE BLVD., SUITE 307
BURBANK, CA. 91502
Phone: 818.566.4000
Fax: 818.566.4090
E-Mail: ACUEVAS@AGCCDC.COM



NO.	DATE	REVISIONS	BY
1	4-1-08	CUP-2	AGC
2	09/03/08	REV. PER PLANNING DEPT.	EJ

RAZE AND REBUILD
6130 BALBOA AVENUE
SAN DIEGO, CA. 92111
BLDG & CANOPY ELEVATIONS

consultant job #	AGC-0014
master release date	06/13/08
project exe date	master drawn by
	SB
File name	AGC0014-CUP-3
Facility/Project	01986
sheet name	CUP-3
	sheet 3 of 8

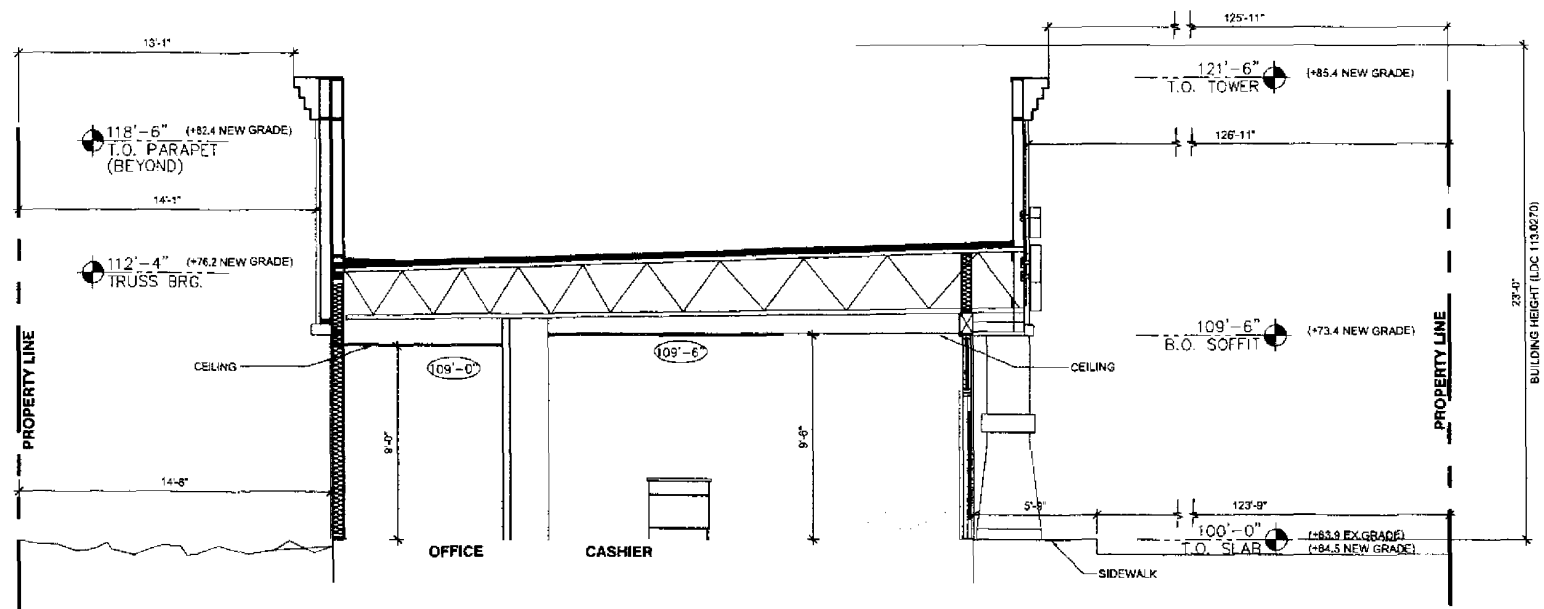

01 FRONT TO REAR BUILDING SECTION
SCALE: 1/4"=1'-0"

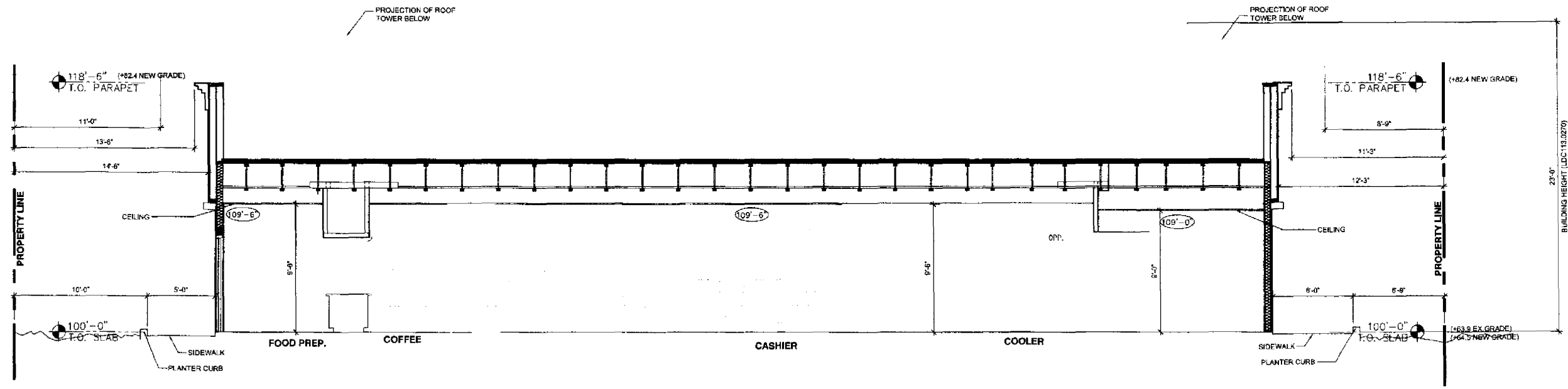

02 LEFT SIDE TO RIGHT SIDE BUILDING SECTION
SCALE: 1/4"=1'-0"

CUP NO. 586793, NUP NO. 623983, PTS NO. 163653, J.O. NO. 43-1512

AGC DESIGN CONCEPT, INC.
350 N. GLENDALES BLVD., SUITE 307
BURBANK, CA 91502
Phone: 818.566.4000
Fax: 818.566.4090
E-Mail: ACUEVAS@AGCDC.COM

NO.	DATE	REV.	PER	REVISIONS	BY
1	09/03/08		REV. PER PLANNING DEPT.		EU

RAZE AND REBUILD
6130 BALBOA AVENUE
SAN DIEGO, CA 92111
BUILDING SECTIONS

consultant job #	AGC-0014
master release date	06/19/08
project exe date	master drawn by
	SB
Filename	2008014-CUP-4
Facility/Project	01986
sheet name	CUP-4
	sheet 1 of 8

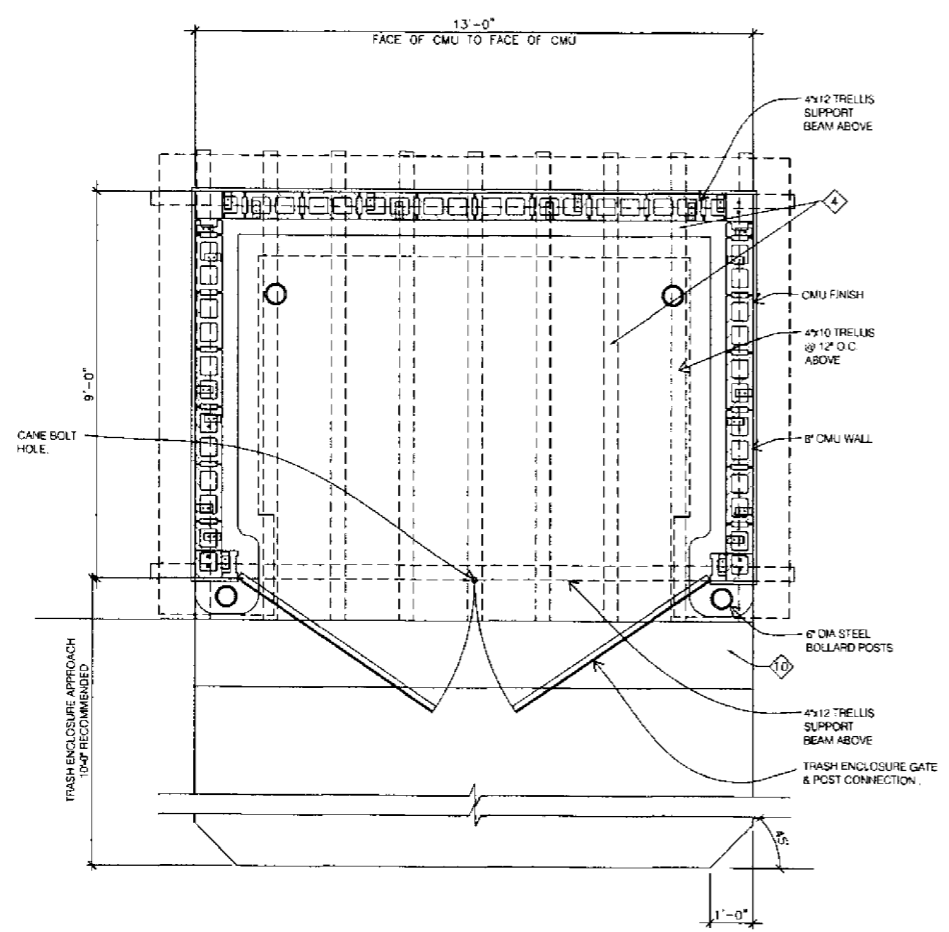

01 FOUNDATION & ROOF FRAMING PLAN
SCALE: 1/2"=1'-0"

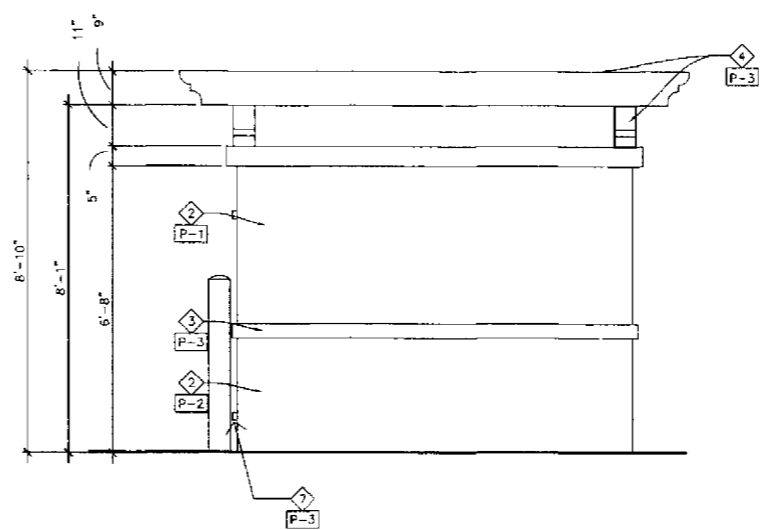

04 SIDE ELEVATION
SCALE: 1/2"=1'-0"

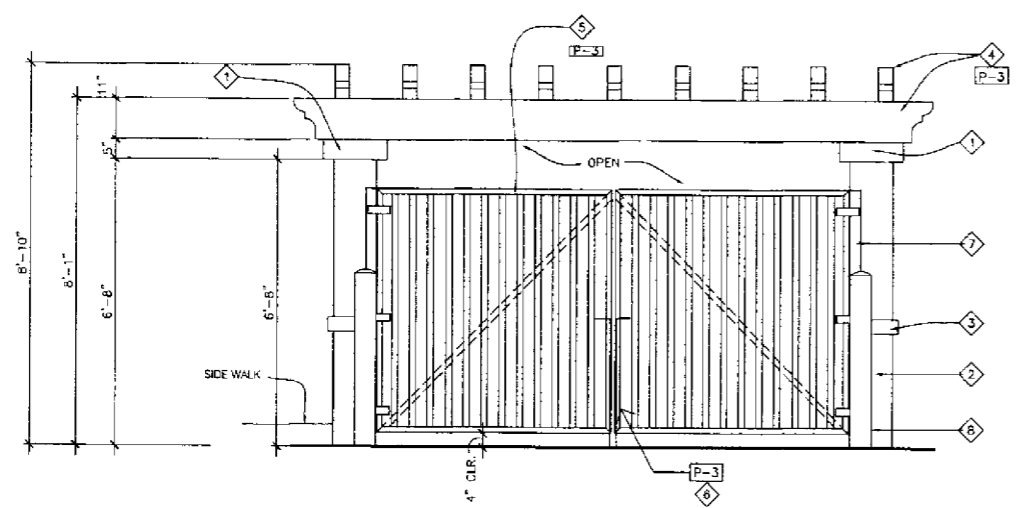

02 FRONT ELEVATIONS
SCALE: 1/2"=1'-0"

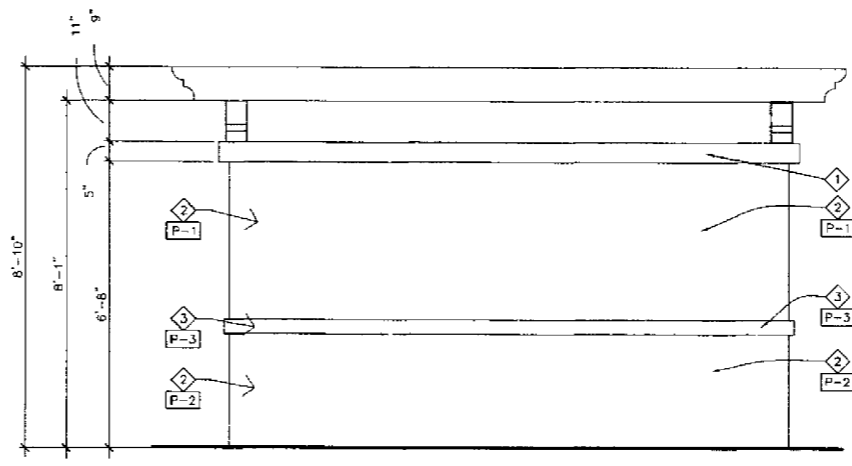

03 REAR ELEVATION
SCALE: 1/2"=1'-0"

Legend	
MARK	DESCRIPTION
1	4"x6" WOOD TRIM
2	3/8" BROWN & 1/8" COLOR COAT STUCCO FINISH OVER C.M.U. (TYP.)
3	2"x4" WOOD TRIM
4	WOOD TRELLIS PAINT P-3
5	CHANNEL FRAME GA. CORRUGATED PAINTED BOTH SIDES COLOR
6	GATE
7	POST
8	BOLLARD POST
9	8"x8"x16" C.M.U. (TYP.)
10	REINFORCED CONCRETE APRON SEE CIVIL PLAN

Paint Legend		
CODE	MATERIAL	MANUFACTURER
P-1	PAINT (EXTERIOR)	ICI # A0717
	COLOR: TAN	INDIAN CORN
P-2	PAINT (EXTERIOR)	ICI # A1761
	COLOR: DARK TAN	ONIONSKIN TAN
P-3	PAINT (EXTERIOR)	ICI # A0767
	COLOR: DARK PEARL	DESERT VALLEY

NOTE:
CEMENT PLASTER SPECIFIED MAY BE SUBSTITUTED W/E.I.F.S. ABOVE WAINSCOT ONLY

ACC DESIGN CONCEPT, INC.
350 N. GLENDALES BLVD. SUITE 307
BURBANK, CA. 91502
Phone: 818.566.4000
Fax: 818.566.4090
E-Mail: ACCUEVAS@AGCCDC.COM

NO.	DATE	REVISIONS	BY
1			EU

RAZE AND REBUILD
6130 BALBOA AVENUE
SAN DIEGO, CA. 92111
TRASH ENCLOSURE

consultant job #	ACC-0014
master release date	05/19/08
project	05/10/08
exe date	05/10/08
master drawn by	SB
File name	ACC0014-CUP-5
Facility/Project	01986
sheet name	CUP-5
	sheet 5 of 8

AGC DESIGN CONCEPT, INC.
 350 N. GLENDALES BLVD., SUITE 307
 BURBANK, CA. 91502
 Phone: 818.566.4000
 Fax: 818.566.4090
 E-Mail: ACUEVAS@AGCCDC.COM



NO.	DATE	REVISIONS
1	BY/13/08	REVISED PER PLANNING

NO.	DATE	REVISIONS

NO.	DATE	REVISIONS

RAZE AND REBUILD
 6130 BALBOA AVENUE
 SAN DIEGO, CA. 92111
SIGN PROGRAM

consultant job #	AGC-0014
master release date	05/19/08
project exe date	05/10/08
master drawn by	ER
File name	AGC0014-SN.1.DWG
Facility/Project	01986
sheet name	CUP-7
	sheet 7 of 8

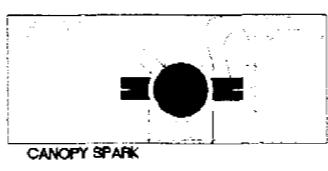
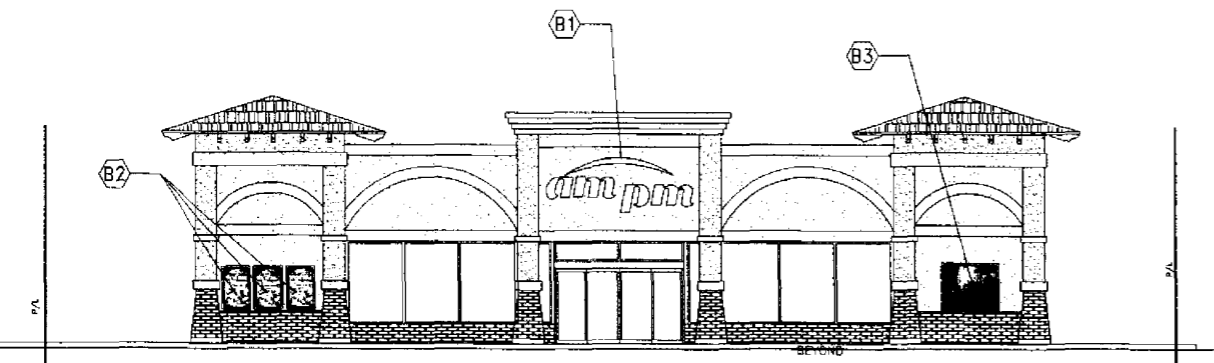

CANOPY SPARK



BUILDING SIGN

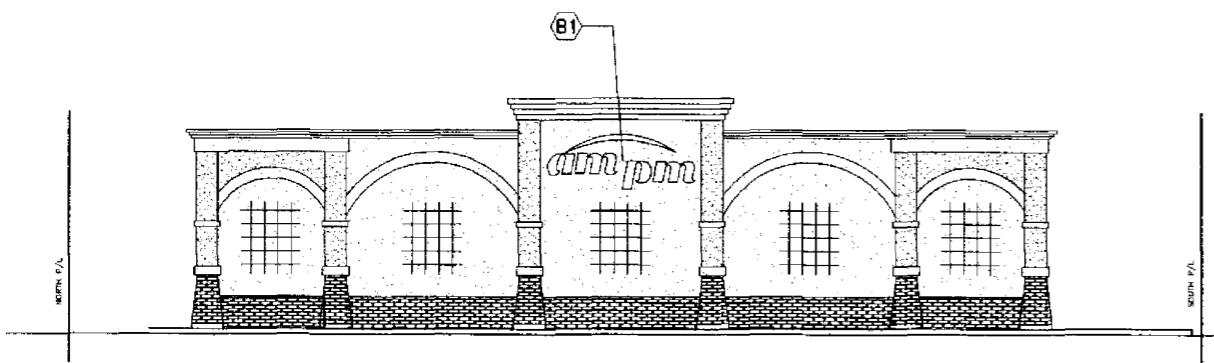

NEW PIC UNIT SIGNAGE, NO PART OF SIGN SUMMARY

NEW DISPENSER SIGNAGE NOT PART OF SIGN SUMMARY

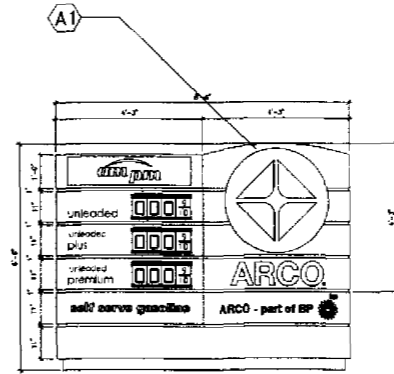
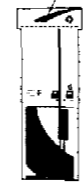

3 ID SIGN

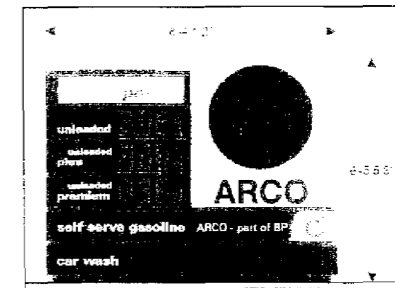

1 EXISTING BUILDING AND NEW CARWASH ELEVATIONS

SCALE: 1/8" = 1'

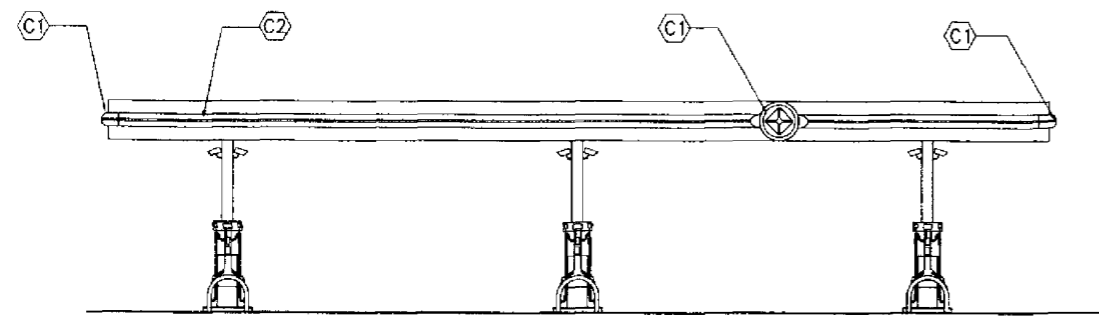

2 CANOPY ELEVATION

SCALE: 1/8" = 1'

PROPOSED SIGN SUMMARY						
MARK	DESCRIPTION	STATUS	DIMENSIONS	AREA (SQ. FT.)	QTY.	TOTAL AREA (SQ. FT.)
A1	ID SIGN SPARK LOGO AND ARCO LETTERS AM/PM LOGO SELF-SERVE GASOLINE / ARCO PART OF BP PANELS	EXISTING	4'-3" X 11" 4'-3" X 4'-3" 8'-6" X 11"	4.1 13.33 16.43	1	33.86
B1	BUILDING (AM/PM SIGN WALL MOUNTED)	NEW	12'-1/2" X 5'-1 1/4"	61.47	2	122.94
B2	TENANT SIGN	NEW	2'-8" X 4'	10.66	3	31.98
B3	TENANT SIGN	NEW	5'-4" X 4'-4"	23.11	1	23.11
C1	CANOPY (ARCO LOGO)	NEW	36" diam	7.06	3	21.18
C2	BULLHOSE WITH LED LIGHT	NEW	278/4" X 15"	347.91	1	347.91
TOTAL NEW SIGN AREA (SQ.FT.)						547.12

- SIGNAGE UNDER SEPARATE PERMIT BY SIGN INSTALLER
- SIGNAGE TO BE PROVIDED AND INSTALLED BY GC.

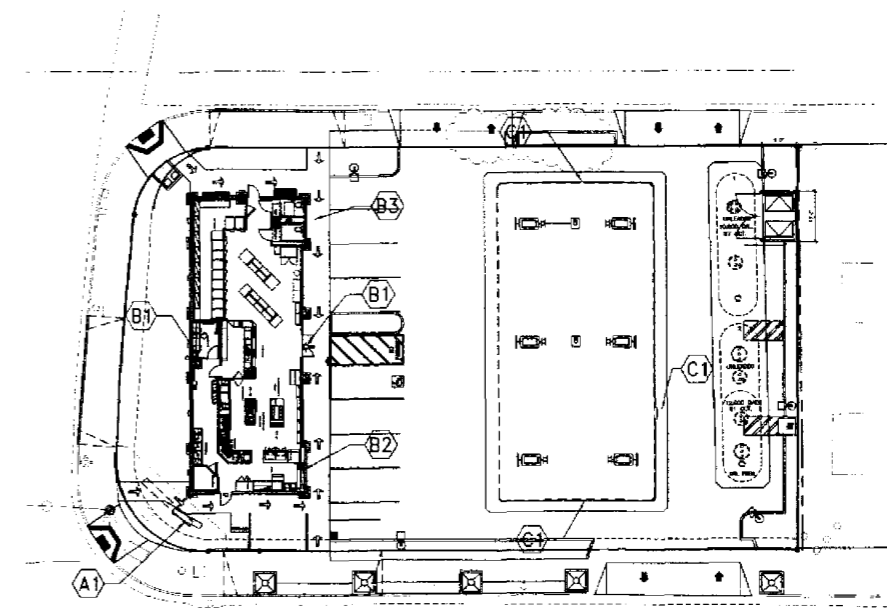

4 Site Plan

SCALE: 1"=40'-0"

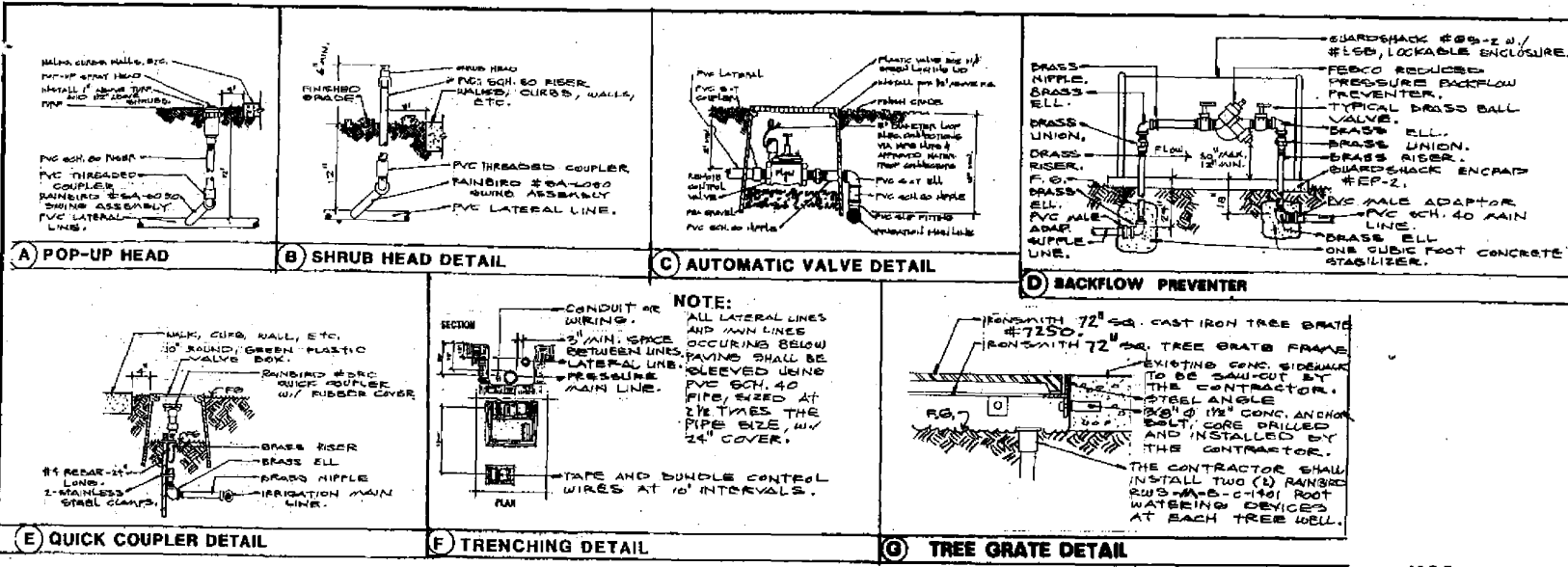

IRRIGATION LEGEND:

SYMBOL	MFG.	MODEL NUMBER	G.P.M.	R.A.D.	P.S.I.	DETAIL
RB	RAIN BIRD	1800-SAM-PRO-MFR-8" Q	GREEN	.26	8"	30
D8	"	1806	"	.52	8"	A
D10	"	1806	"	.77	10"	A
D12	"	1806	"	.65	12"	A
D15	"	1806	"	.92	15"	A
D15	"	1806	"	1.25	15"	A
D15	"	1806	"	3.70	15"	A
D8	"	PA-85-PRG-MFR-8" Q	GREEN	.26	8"	B
D10	"	PA-105	"	.39	10"	B
D12	"	PA-125	"	.65	12"	B
D15	"	PA-155	"	.92	15"	B
V15	"	PA-155	"	1.85	15"	B
V15	"	PA-155	"	3.70	15"	B
◆	"	RWS-A-B-C-140	"	.25	"	C

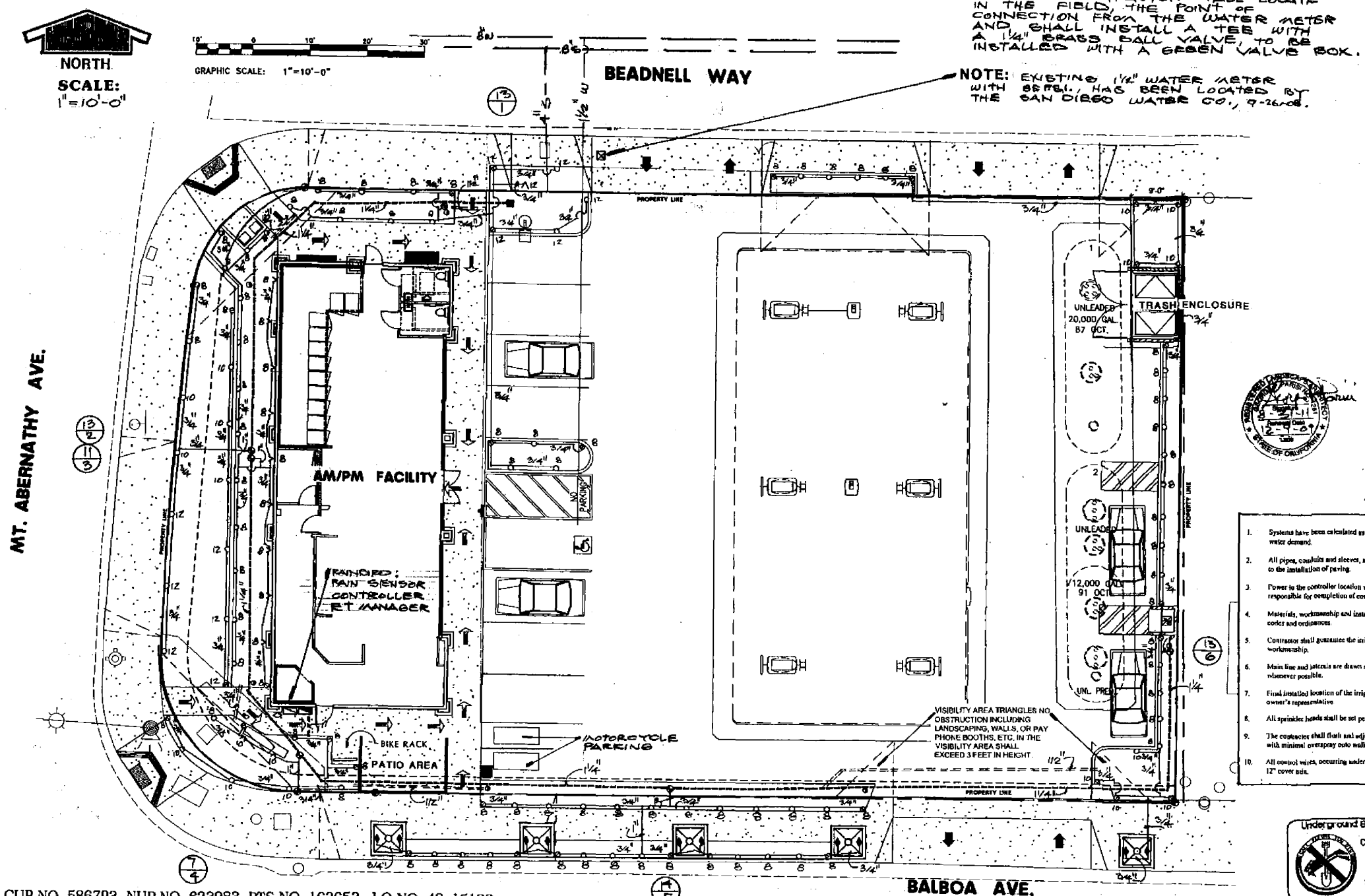

- ☑ EXISTING 1/2" WATER METER
- RAINBIRD WIRELESS RAIN SENSOR - WRSC
- SUPERIOR #950-1" REMOTE CONTROL BRASS GLOBE VALVE - SEE DETAIL C
- RAINBIRD #SRC-1" QUICK COUPLER - SEE DETAIL E
- FEBCO #825Y-1/4" REDUCED PRESSURE BACKFLOW PREVENTER TO BE INSTALLED WITH COAST GUARD SHACK #GS-2 ENCLOSURE AND #EP-2 ENCPAD SEE DETAIL D
- ☑ RAINBIRD #ESP-7 STATION MODULAR SERIES CONTROLLER, TO BE INSTALLED WITH A CLOCK GUARD #CG-1 ENCLOSURE
- ☑ RAINBIRD #ETM1: ET MANAGER, TO BE INSTALLED WITH A #ETM1-OR-OUTDOOR ENCLOSURE, NEXT TO THE CONTROLLER
- APPROVED PVC LATERAL LINE, SCH. 40 W/ 12" COVER
- APPROVED PVC MAIN LINE, SCH. 40 W/ 18" COVER
- APPROVED PVC CONDUIT, SCH. 40 FOR CONTROLLER WIRE W/ 18" COVER - SEE PLAN FOR SIZE.
- ⑬ SYSTEM WATER DEMAND IN GALLONS PER MINUTE IDENTIFICATION NUMBER

NOTES:

- THE LANDSCAPE CONTRACTOR SHALL CALL MRS. ANITA MATLOCK OF RAINBIRD FOR THE CORRECT WEATHER STATION CODE FOR THE ET MANAGER, CELL PHONE 951-34-1740
- THE LANDSCAPE CONTRACTOR SHALL PROGRAM THE CONTROLLER PER RAINBIRD'S RECOMMENDATIONS AND SHALL CONSULT WITH MRS. MATLOCK OF RAINBIRD FOR ANY ADDITIONAL INSTRUCTIONS.

GENERAL IRRIGATION NOTES:

1. Systems have been calculated using 25 PSI static pressure and 14 GPM maximum water demand.
2. All pipe, couplings and sleeves, shown on plan, crossing paving, shall be installed prior to the installation of paving.
3. Power to the controller will be provided by owner. Contractor shall be responsible for completion of controller hookup.
4. Materials, workmanship and installation shall be installed in accordance with all local codes and ordinances.
5. Contractor shall guarantee the irrigation system for a period of one year for materials and workmanship.
6. Main line and jetties are drawn schematically and are to be installed in plotted areas whenever possible.
7. Final installed location of the irrigation controller shall be approved by the owner or the owner's representative.
8. All sprinkler heads shall be set perpendicular to finish grade unless otherwise specified.
9. The contractor shall flush and adjust all sprinkler heads and valves for optimum coverage with minimal overpray onto walks, streets, walls, etc.
10. All control wires, occurring under paving, shall be installed in PVC Sch. 40 sleeves, with 12" cover.
11. All lateral line piping, occurring below paving, shall be PVC Sch. 40 and shall be installed prior to paving.
12. Pipe sizes shall conform to those shown on the drawings. No substitutions of smaller pipe sizes shall be permitted, but substitutions of larger sizes may be approved.
13. It is the responsibility of the irrigation contractor to familiarize himself with all grade differences, location of walls, structures and utilities. The irrigation contractor shall repair or replace all items damaged by his work. The irrigation contractor shall coordinate his work with other contractors for the location and installation of all PVC pipes, conduits, sleeves and laterals through walls, under roadways and paving.
14. All sprinkler equipment, not otherwise detailed or specified, shall be installed as per manufacturer's recommendations and specifications.
15. These plans are diagrammatic - adjust to fit field conditions for 100% coverage.
16. Head layout is designed for head to head coverage. Adjust nozzle and R.C.V. to eliminate over/under and mist spray.
17. Place control wire in main line trench, secure with 10 mil. tape to the underside of main line at 10' on center.
18. Main line shall be pressure checked at 1 1/2 times existing static pressure. All lateral lines placed under pavement shall be pressure checked at existing static pressure.
19. All quick couplers shall be installed within 18" of walks and drive ways and within stub area, not grass areas, for ease of access.

Underground Service Alert
 Call: TOLL FREE
 1-800-227-2600
 TWO WORKING DAYS BEFORE YOU DIG

HOLD HARMLESS AND INDEMNIFICATION CLAUSE:

Contractor agrees that he shall assume sole responsibility for job site conditions during the course of construction of this project, including safety of all persons and property, that this requirement shall apply continuously and not be limited to normal working hours, and that the contractor shall defend, indemnify, and hold the owner and the landscape architect harmless from any and all liability, loss or alleged, in connection with the performance of work on this project, except for liability arising from the sole negligence of the owner or the landscape architect.

These drawings and specifications are the property and copyright of George P. Parisi and Associates, landscape architect, and shall not be used on any work except by agreement with George P. Parisi and Associates. Written dimensions take precedence over scaled dimensions and shall be verified by the contractor on the job site. Any discrepancy shall be brought to the attention of George P. Parisi and Associates, prior to the commencement of any work.

George P. Parisi and Associates
 LANDSCAPE ARCHITECTURE
 17158 E. Ridge Park Dr.
 Hacienda Heights, CA 91745 (626) 944-5711

IRRIGATION PLAN

ARCO AM/PM FACILITY
 6130 BALBOA AVE.
 SAN DIEGO, CALIF.
 AGENT: ALEX CUBERVAS of ARCO

Sheet
 1 of 2

RESOLUTION NUMBER R-_____

ADOPTED ON _____

WHEREAS, on January 9, 2009, Alex Cuevas submitted an application to the Development Services Department for a Planned Development Permit, Site Development Permit, Neighborhood Use Permit, Rezone, and Conditional Use Permit and

WHEREAS, the permit was considered by the Planning Commission of the City of San Diego; and

WHEREAS, under Charter section 280(a)(2) this resolution is not subject to veto by the Mayor because this matter requires the City Council to act as a quasi-judicial body and where a public hearing was required by law implicating due process rights of individuals affected by the decision and where the Council was required by law to consider evidence at the hearing and to make legal findings based on the evidence presented; and

WHEREAS, the issue was considered by the Planning Commission of the City of San Diego on June 23, 2011; and

WHEREAS, the Planning Commission of the City of San Diego considered the issues discussed in Negative Declaration No 163653; NOW THEREFORE,

BE IT RESOLVED, by of the City of San Diego, that it is hereby certified that Negative Declaration No.163653 has been completed in compliance with the California Environmental Quality Act of 1970 (California Public Resources Code Section 21000 et seq.) as amended, and the State guidelines thereto (California Administrative Code Section 15000 et seq.), that the report reflects the independent judgment of the City of San Diego as Lead Agency and that the information contained in said report, together with any comments received during the public review process, has been reviewed and considered by the Planning Commission of the City of San Diego; directing staff to file a Notice of Determination.

BE IT FURTHER RESOLVED that Planning Commission of the City of San Diego of the City of San Diego finds, based upon the Initial Study and any comments received, that there is no substantial evidence that the project will have a significant effect on the environment and therefore, that said Negative Declaration is hereby approved.

APPROVED: _____

By: _____
Development Project Manager



CITY OF SAN DIEGO • DEVELOPMENT SERVICES

PROPOSED REZONING

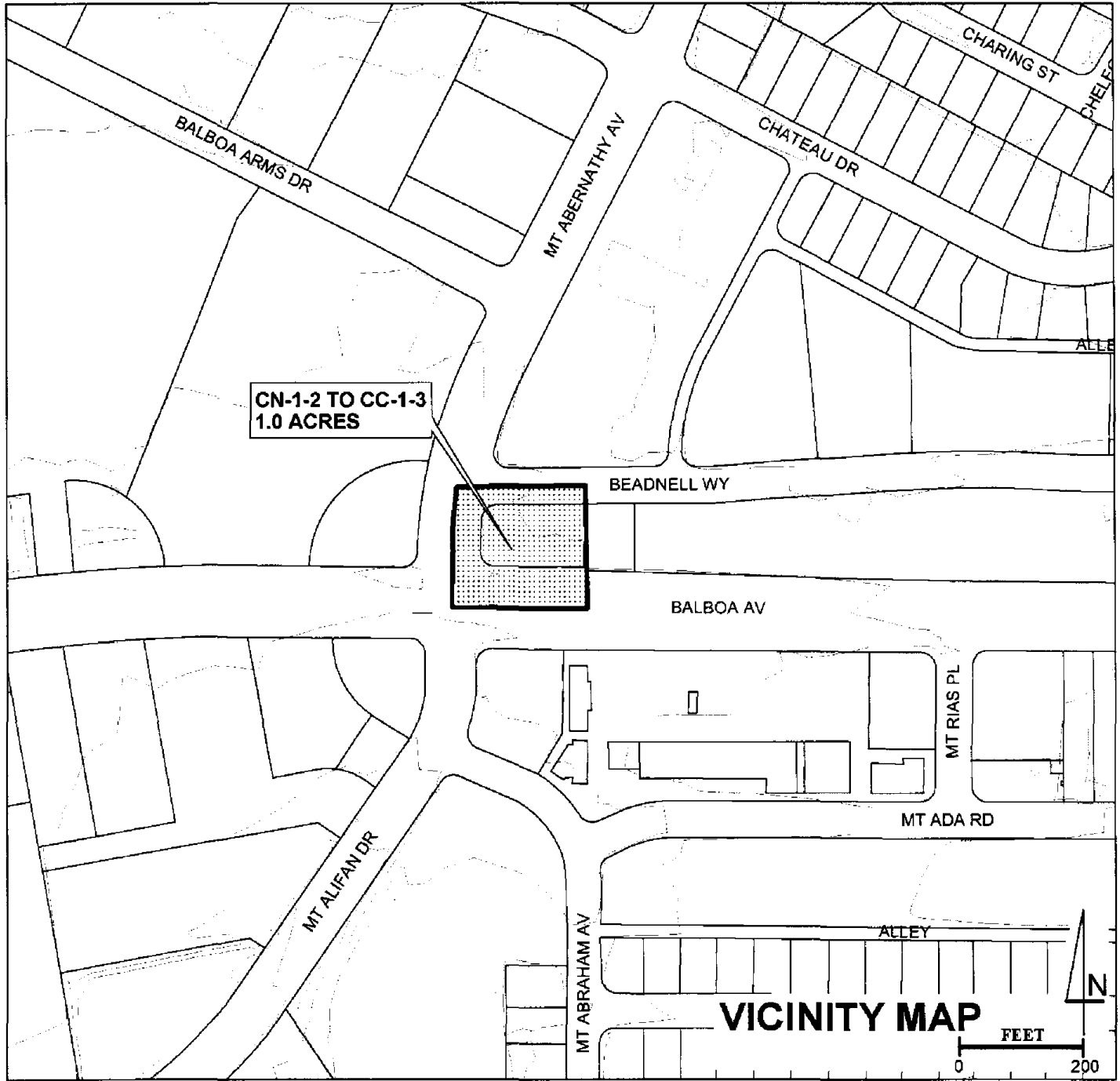

LOT 3, BALBOA ANNEX UNIT#2, MAP 5119

ORDINANCE NO. _____
 EFF. DATE ORD. _____
 ZONING SUBJ. TO _____
 BEFORE DATE _____
 EFF. DATE ZONING _____
 MAP NAME AND NO. _____

REQUEST **CC-1-3**
 PLANNING COMM.
 RECOMMENDATION
 CITY COUNCIL
 ACTION

CASE NO. 43-1512

DEVELOPMENT SERVICES MANAGER

B- 4286

APN: 362-240-03

(238-1713) 3-18-11 ldj

Rezone Ordinance

(O-XXXX)

ORDINANCE NUMBER O-_____ (NEW SERIES)

ADOPTED ON

AN ORDINANCE OF THE COUNCIL OF THE CITY OF SAN DIEGO CHANGING 1.0 ACRE LOCATED AT 6130 BALBOA AVENUE, WITHIN THE CLAIREMONT MESA COMMUNITY PLAN AREA, IN THE CITY OF SAN DIEGO, CALIFORNIA, FROM THE CN-1-2 ZONE INTO THE CC-1-3 ZONE, AS DEFINED BY SAN DIEGO MUNICIPAL CODE SECTION 131.0507; AND REPEALING ORDINANCE NO. R-301263 (NEW SERIES), ADOPTED FEBRUARY 28, 2006, OF THE ORDINANCES OF THE CITY OF SAN DIEGO IN SO FAR AS THE SAME CONFLICT HEREWITH.

WHEREAS, under Charter section 280(a)(2) this ordinance is not subject to veto by the Mayor because this matter requires the City Council to act as a quasi-judicial body and where a public hearing was required by law implicating due process rights of individuals affected by the decision and where the Council was required by law to consider evidence at the hearing and to make legal findings based on evidence presented; NOW, THEREFORE,

BE IT ORDAINED, by the Council of the City of San Diego, as follows:

Section 1. That 1.0 acre located at 6130 Balboa Avenue, and legally described as Lot 3, Balboa Annex Unit No. 2, Map No. 5119, in the Clairemont Mesa Community Plan area, in the City of San Diego, California, as shown on Zone Map Drawing No. B-4286, filed in the office of the City Clerk as Document No. OO- _____, are rezoned from the CN-1-2 into the CC-1-3 zone, as the zone is described and defined by San Diego Municipal Code Chapter 13 Article 1 Division 5. This action amends the Official Zoning Map adopted by Resolution R-301263 on February 28, 2006.

ATTACHMENT 8

Section 2. That Ordinance No.) O-8566 (New Series), adopted January 21, 1963, of the ordinances of the City of San Diego is repealed insofar as the same conflict with the rezoned uses of the land.

Section 3. That a full reading of this ordinance is dispensed with prior to its final passage, a written or printed copy having been available to the City Council and the public a day prior to its final passage.

Section 4. This ordinance shall take effect and be in force on the thirtieth day from and after its passage, and no building permits for development inconsistent with the provisions of this ordinance shall be issued unless application therefore was made prior to the date of adoption of this ordinance.

APPROVED: JAN GOLDSMITH, City Attorney

By _____
Andrea Dixon
Deputy City Attorney

Initials~
Date~
Or.Dept: DSD
Case No.163653
O-XXXX

RECORDING REQUESTED BY
CITY OF SAN DIEGO
DEVELOPMENT SERVICES
PERMIT INTAKE, MAIL STATION 501

WHEN RECORDED MAIL TO
CITY CLERK
MAIL STATION 2A

SPACE ABOVE THIS LINE FOR RECORDER'S USE

INTERNAL ORDER NUMBER: 23431512

CONDITIONAL USE PERMIT NO. 586793
SITE DEVELOPMENT PERMIT NO. 586794
PLANNED DEVELOPMENT PERMIT NO. 840713
NEIGHBORHOOD USE PERMIT NO. 623983
ARCO BALBOA AVENUE – PROJECT NO. 163653
AMENDMENT
CITY COUNCIL

This Conditional Use Permit No. 586793, Site Development Permit No. 586794, Planned Development Permit No. 840713, and Neighborhood Use Permit No. 623983, amendment to Conditional Use Permit No. 83-0729 is granted by the City Council of the City of San Diego to Seven Clairemont Properties, A California General Partnership, Owner, and BP West Coast Products, LLC, Permittee, pursuant to San Diego Municipal Code [SDMC] sections 126.0305, 126.0504, 126.0604 and 126.0404. The 0.42 -acre site is located at 6130 Balboa Avenue in the CN-1-2, to be rezoned to CC-1-3, the Airport Influence Overlay, FAA Part 77, Clairemont Mesa Height Limit Overlay, and Community Plan Implementation Overlay Zone Area B, within the Clairemont Mesa Community Plan area. The project site is legally described as Lot 3, Balboa Annex Unit No. 2, Map No. 5119.

Subject to the terms and conditions set forth in this Permit, permission is granted to Owner and Permittee to continue to operate an alcoholic beverage outlet, and to demolish an existing gas station and construct a new gas station with a 2,400 square foot convenience store and 3,400 square foot canopy with six (6) fuel dispensers, and subject to the City's land use regulations] described and identified by size, dimension, quantity, type, and location on the approved exhibits [Exhibit "A"] dated XXXXX, on file in the Development Services Department.

The project shall include:

- a. The construction of a 24-hour service station including a new 2,400 square foot convenience store and 3,400 square foot canopy with six (6) fuel dispensers with subterranean tanks;
- b. Continued operation of a Type 20 (off-site consumption, beer and wine only) alcoholic beverage outlet conditioned upon the continuance of a license from the State Department of Alcoholic Beverage Control;
- c. Landscaping (planting, irrigation and landscape related improvements);
- b. Off-street parking; and
- c. Public and private accessory improvements determined by the Development Services Department to be consistent with the land use and development standards for this site in accordance with the adopted community plan, the California Environmental Quality Act [CEQA] and the CEQA Guidelines, the City Engineer's requirements, zoning regulations, conditions of this Permit, and any other applicable regulations of the SDMC.

STANDARD REQUIREMENTS:

1. This permit must be utilized within thirty-six (36) months after the date on which all rights of appeal have expired. If this permit is not utilized in accordance with Chapter 12, Article 6, Division 1 of the SDMC within the 36 month period, this permit shall be void unless an Extension of Time has been granted. Any such Extension of Time must meet all SDMC requirements and applicable guidelines in effect at the time the extension is considered by the appropriate decision maker.
2. No permit for the construction, occupancy, or operation of any facility or improvement described herein shall be granted, nor shall any activity authorized by this Permit be conducted on the premises until:
 - a. The Owner/Permittee signs and returns the Permit to the Development Services Department; and
 - b. The Permit is recorded in the Office of the San Diego County Recorder.
3. While this Permit is in effect, the subject property shall be used only for the purposes and under the terms and conditions set forth in this Permit unless otherwise authorized by the appropriate City decision maker.
4. This Permit is a covenant running with the subject property and all of the requirements and conditions of this Permit and related documents shall be binding upon the Owner/Permittee and any successor(s) in interest.

5. The continued use of this Permit shall be subject to the regulations of this and any other applicable governmental agency.
6. Issuance of this Permit by the City of San Diego does not authorize the Owner/Permittee for this Permit to violate any Federal, State or City laws, ordinances, regulations or policies including, but not limited to, the Endangered Species Act of 1973 [ESA] and any amendments thereto (16 U.S.C. § 1531 et seq.).
7. The Owner/Permittee shall secure all necessary building permits. The Owner/Permittee is informed that to secure these permits, substantial building modifications and site improvements may be required to comply with applicable building, fire, mechanical, and plumbing codes, and State and Federal disability access laws.
8. Construction plans shall be in substantial conformity to Exhibit "A." Changes, modifications, or alterations to the construction plans are prohibited unless appropriate application(s) or amendment(s) to this Permit have been granted.
9. All of the conditions contained in this Permit have been considered and were determined-necessary to make the findings required for approval of this Permit. The Permit holder is required to comply with each and every condition in order to maintain the entitlements that are granted by this Permit.

If any condition of this Permit, on a legal challenge by the Owner/Permittee of this Permit, is found or held by a court of competent jurisdiction to be invalid, unenforceable, or unreasonable, this Permit shall be void. However, in such an event, the Owner/Permittee shall have the right, by paying applicable processing fees, to bring a request for a new permit without the "invalid" condition(s) back to the discretionary body which approved the Permit for a determination by that body as to whether all of the findings necessary for the issuance of the proposed permit can still be made in the absence of the "invalid" condition(s). Such hearing shall be a hearing de novo, and the discretionary body shall have the absolute right to approve, disapprove, or modify the proposed permit and the condition(s) contained therein.

10. The Owner/Permittee shall defend, indemnify, and hold harmless the City, its agents, officers, and employees from any and all claims, actions, proceedings, damages, judgments, or costs, including attorney's fees, against the City or its agents, officers, or employees, relating to the issuance of this permit including, but not limited to, any action to attack, set aside, void, challenge, or annul this development approval and any environmental document or decision. The City will promptly notify Owner/Permittee of any claim, action, or proceeding and, if the City should fail to cooperate fully in the defense, the Owner/Permittee shall not thereafter be responsible to defend, indemnify, and hold harmless the City or its agents, officers, and employees. The City may elect to conduct its own defense, participate in its own defense, or obtain independent legal counsel in defense of any claim related to this indemnification. In the event of such election, Owner/Permittee shall pay all of the costs related thereto, including without limitation reasonable attorney's fees and costs. In the event of a disagreement between the City and Owner/Permittee regarding litigation issues, the City shall have the authority to

control the litigation and make litigation related decisions, including, but not limited to, settlement or other disposition of the matter. However, the Owner/Permittee shall not be required to pay or perform any settlement unless such settlement is approved by Owner/Permittee.

ENGINEERING REQUIREMENTS:

11. The drainage system proposed for this development, as shown on the site plan, is private and subject to approval by the City Engineer.
12. Prior to the issuance of any building permits, the Owner/Permittee shall obtain an Encroachment Maintenance Removal Agreement, from the City Engineer, for the curb drain in the Balboa Avenue Right-of-Way.
13. Prior to the issuance of any building permits, the Owner/Permittee shall assure, by permit and bond, the construction of a current City Standard 35 feet wide driveway, adjacent to the site on Balboa Avenue and two 30 feet wide driveways, adjacent to the site on Beadnell Way.
14. Prior to the issuance of any building permits, the Owner/Permittee shall assure, by permit and bond, the closure of the non-utilized driveways with current City Standard curb, gutter and sidewalk, adjacent to the site on Balboa Avenue, Mt Abernathy, and Beadnell Way.
15. Prior to the issuance of any building permits, the Owner/Permittee shall assure, by permit and bond, to reconstruct the existing curb ramps at the northeast corner of Balboa Avenue and Mount Abernathy Avenue and at the southeast corner of Mount Abernathy and Beadnell Way, with current City Standard curb ramp Standard Drawing SDG-130 and SDG-132 with truncated domes.
16. Prior to the issuance of any construction permit, the Owner/Permittee shall enter into a Maintenance Agreement for the ongoing permanent BMP maintenance, satisfactory to the City Engineer.
17. Prior to the issuance of any construction permit, the Owner/Permittee shall incorporate any construction Best Management Practices necessary to comply with Chapter 14, Article 2, Division 1 (Grading Regulations) of the San Diego Municipal Code, into the construction plans or specifications.
18. Prior to the issuance of any construction permit the Owner/Permittee shall submit a Water Pollution Control Plan (WPCP). The WPCP shall be prepared in accordance with the guidelines in Appendix E of the City's Storm Water Standards.
19. Prior to the issuance of any construction permit the Owner/Permittee shall incorporate and show the type and location of all post-construction Best Management Practices (BMP's) on the final construction drawings, consistent with the approved Water Quality Technical Report.
20. The project proposes to export 480 cubic yards of material from the project site. All excavated material listed to be exported, shall be exported to a legal disposal site in accordance

with the Standard Specifications for Public Works Construction (the "Green Book"), 2003 edition and Regional Supplement Amendments adopted by Regional Standards Committee.

21. Prior to the issuance of any building permits, the Owner/Permittee shall dedicate an additional 5 feet on Mount Abernathy to provide a 15 foot curb-to-property-line distance, satisfactory to the City Engineer.
22. Prior to the issuance of any building permits, the Owner/Permittee shall dedicate an additional 3 feet on Balboa Avenue to provide a 15 foot curb-to-property-line distance, satisfactory to the City Engineer.
23. Whenever street rights-of-way are required to be dedicated, it is the responsibility of the Owner/Permittee to provide the right-of-way free and clear of all encumbrances and prior easements. The Applicant must secure "subordination agreements" for minor distribution facilities and/or "joint-use agreements" for major transmission facilities.

LANDSCAPE REQUIREMENTS:

24. Prior to issuance of any construction permits for public right-of-way improvements, complete landscape construction documents for right-of-way improvements shall be submitted to the Development Services Department for approval. Improvement plans shall show, label and dimension a 40 square foot area around each tree which is unencumbered by utilities. Driveways, utilities, drains, water and sewer laterals shall be designed so as not to prohibit the placement of street trees.
25. Prior to issuance of any grading permits, complete landscape construction documents, including an automatic permanent irrigation system, shall be submitted to the Development Services Department for approval. The plans shall be in substantial conformance to Exhibit 'A', on file in the office of Development Services.
26. If any required landscape (including existing or new plantings, hardscape, landscape features, etc.) indicated on the approved construction document plans is damaged or removed during demolition or construction, it shall be repaired and/or replaced in kind and equivalent size per the approved documents to the satisfaction of the Development Services Department within 30 days of damage or Certificate of Occupancy or a Final Landscape Inspection.
27. Any required planting that dies within 3 years of installation shall be replaced within 30 calendar days of plant death with the same size and species of plant material shown on the approved plan. Required shrubs or trees that die 3 years or more after installation shall be replaced with 15 gallon size or 60-inch box size material, respectively. Development Services may authorize adjustment of the size and quantity of replacement material where material replacement would occur in inaccessible areas or where the existing plant being replaced is larger than a 15 gallon shrub or 60-inch box tree.

PLANNING/DESIGN REQUIREMENTS:

28. 11 automobile parking spaces (including 1 van accessible space) and 2 motorcycle parking spaces are required by the Land Development Code and shall be provided as shown on the project's Exhibit "A." All on-site parking stalls and aisle widths shall be in compliance with the requirements of the City's Land Development Code and shall not be converted and/or utilized for any other purpose, unless otherwise authorized in writing by the Development Services Director.

29. Prior to the issuance of any construction permits, the applicant shall provide verification, in letter form, to the Mitigation Monitoring and Coordination Section (MMC) that the County of San Diego, Department of Environmental Health has reviewed and approved the proposed Health and Safety Work Plan for the treatment and disposal of hazardous materials or contaminated soils that may be encountered within the project site.

The work plan would contain specific procedures for encountering both expected and unexpected contaminants. The plan would prescribe safe work practices, contaminant monitoring, personal protective equipment, emergency response procedures, and safety training requirements for the protection of construction workers and third parties. The health and safety plan would meet the requirements of 29 CFR 1910 and 1926, and all other applicable federal, state, and local requirements.

30. A topographical survey conforming to the provisions of the SDMC may be required if it is determined, during construction, that there may be a conflict between the building(s) under construction and a condition of this Permit or a regulation of the underlying zone. The cost of any such survey shall be borne by the Owner/Permittee.

31. All signs associated with this development shall be consistent with sign criteria established by either the approved Exhibit "A" or City-wide sign regulations.

32. All private outdoor lighting shall be shaded and adjusted to fall on the same premises where such lights are located and in accordance with the applicable regulations in the SDMC.

POLICE DEPARTMENT RECOMMENDATIONS:

33. Exterior advertising of alcoholic beverages, or interior advertising of alcoholic beverages that is visible from the exterior of the premises shall be prohibited. [Note: Any restrictions on alcohol advertising need to be supported by evidence of the City's substantial interest in imposing the restriction (for example, to prevent under-age drinking), that the restriction directly advances that substantial interest, and that the restriction goes no further than necessary to advance the interest (e.g., advertising still allowed in areas not frequented by minors)].

34. Exterior public pay phones are not permitted on the premises, adjacent public sidewalks, or areas under the control of the owner or operator.

35. The sign area pertaining to or referencing alcoholic sales or beverages shall not exceed 630 square inches. A maximum of 33 percent of the square footage of the windows and doors of the

premises may bear advertising or signs of any sort, and all advertising and signs shall be placed and maintained in a manner that ensures that law enforcement personnel have a clear and unobstructed view of the interior of the outlet.

37. The owner or operator of the alcoholic beverage outlet shall post a prominent, permanent sign or signs stating, "No loitering, consumption of alcoholic beverages, or open alcoholic beverage containers are allowed inside the premises, in the parking area, or on the public sidewalks adjacent to the premises.

38. The owner or operator shall maintain the premises, adjacent public sidewalks, and areas under the control of the owner or operator, free of litter and graffiti at all times. The owner or operator shall provide for daily removal of trash, litter, and debris. The owner or operator shall eliminate graffiti within 48 hours of application.

TRANSPORTATION REQUIREMENTS

39. Prior to the issuance of any permits, the applicant shall dedicate 3 feet along Balboa Avenue to provide a minimum 15 feet curb to property line distance, satisfactory to the City Engineer.

40. Prior to the issuance of any permits, the applicant shall dedicate 5 feet along Mt. Abernathy Avenue to provide a minimum 15 feet curb to property line distance, satisfactory to the City Engineer.

WASTEWATER REQUIREMENTS:

41. Utilization of existing sewer laterals is at the sole risk and responsibility of the developer to ensure the laterals are functional and connected to a public sewer facility. Prior to connecting to any existing sewer lateral, the lateral shall be inspected using a closed-circuit television (CCTV) by a California Licensed Plumbing Contractor to verify the lateral is in good working condition and free of all debris.

42. All proposed private sewer facilities located within a single lot are to be designed to meet the requirements of the California Uniform Plumbing Code and will be reviewed as part of the building permit plan check.

43. All proposed public sewer facilities are to be designed and constructed in accordance with established criteria in the most current City of San Diego sewer design guide.

44. No trees or shrubs exceeding three feet in height at maturity shall be installed within ten feet of any public sewer facilities.

WATER REQUIREMENTS:

45. Prior to the issuance of any building permits, the Owner/Permittee shall assure, by permit and bond, the design and construction of new water service(s) outside of any driveway, and the

removal of all existing unused services, within the right-of-way adjacent to the project site, in a manner satisfactory to the Director of Public Utilities and the City Engineer.

46. Prior to the issuance of any building permits, the Owner/Permittee shall apply for a plumbing permit for the installation of appropriate private back flow prevention device(s) on each water service (domestic, fire and irrigation) within the development, in a manner satisfactory to the Director of Public Utilities and the City Engineer.

47. Prior to the issuance of any certificates of occupancy, the public water facilities, necessary to serve this development, shall be complete and operational in a manner satisfactory to the Director of Public Utilities and the City Engineer.

48. The Owner/Permittee shall design and construct all proposed public water facilities in accordance with established criteria in the current edition of the City of San Diego Water Facility Design Guidelines and City regulations, standards and practices.

INFORMATION ONLY:

- The issuance of this discretionary use permit alone does not allow the immediate commencement or continued operation of the proposed use on site. The operation allowed by this discretionary use permit may only begin or recommence after all conditions listed on this permit are fully completed and all required ministerial permits have been issued and received final inspection.
- Any party on whom fees, dedications, reservations, or other exactions have been imposed as conditions of approval of this Permit, may protest the imposition within ninety days of the approval of this development permit by filing a written protest with the City Clerk pursuant to California Government Code-section 66020.
- This development may be subject to impact fees at the time of construction permit issuance.

APPROVED by the City Council of the City of San Diego onXXXXXand [Approved Resolution Number].

CUP-586793/SDP-586794/PDP-840713/NUP-623983

Date of Approval: xxxxxxxx

AUTHENTICATED BY THE CITY OF SAN DIEGO DEVELOPMENT SERVICES
DEPARTMENT

Jeannette Temple
Development Project Manager

**NOTE: Notary acknowledgment
must be attached per Civil Code
section 1189 et seq.**

The undersigned Owner/Permittee, by execution hereof, agrees to each and every condition of
this Permit and promises to perform each and every obligation of Owner/Permittee hereunder.

Seven Clairemont Properties
Owner

By _____
NAME
TITLE

BP West Coast Products
Owner/Permittee

By _____
NAME
TITLE

**NOTE: Notary acknowledgments
must be attached per Civil Code
section 1189 et seq.**

Resolution for Approving Permits

(R-XXXX)

RESOLUTION NUMBER R-XXXX

ADOPTED ON XXXX

WHEREAS, Seven Clairemont Properties, Owner, and BP West Coast Products, LLC, Permittee, filed an application with the City of San Diego for a Conditional Use Permit No. 586793, Site Development Permit No. 586794, Planned Development Permit No. 840713, and Neighborhood Use Permit No. 623983, amendment to Conditional Use Permit No. 83-0729, to continue to operate an alcoholic beverage outlet, and to demolish an existing gas station and construct a new gas station with a 2,400 square foot convenience store and 3,400 square foot canopy with six (6) fuel dispensers, known as the ARCO Balboa Avenue project, Project No. 163653, located at 6130 Balboa Avenue, and legally described as Lot 3, Balboa Annex Unit No. 2, Map No. 5119, in the Clairemont Mesa Community Plan area, in the CN-1-2 zone which is proposed to be rezoned to the CC-1-3 zone, and located within the Airport Influence Overlay, FAA Part 77, Clairemont Mesa Height Limit Overlay, and Community Plan Implementation Overlay Zone Area B; and

WHEREAS, on June 23, 2011, the Planning Commission of the City of San Diego considered Conditional Use Permit (CUP) No. 586793, Site Development Permit (SDP) No. 586794, Planned Development Permit (PDP) No. 840713, and Neighborhood Use Permit (NUP) No. 623983, and pursuant to Resolution No. PC-XXXX voted to recommend City Council approval of the permit; and

WHEREAS, under Charter section 280(a)(2) this resolution is not subject to veto by the Mayor because this matter requires the City Council to act as a quasi-judicial body and where a public

hearing was required by law implicating due process rights of individuals affected by the decision and where the Council was required by law to consider evidence at the hearing and to make legal findings based on the evidence presented; and

WHEREAS, the matter was set for public hearing on XXXX, testimony having been heard, evidence having been submitted, and the City Council having fully considered the matter and being fully advised concerning the same; NOW, THEREFORE,

BE IT RESOLVED, by the Council of the City of San Diego, that it adopts the following findings with respect to CUP No. 586793, SDP No. 586794, PDP No. 840713, and NUP No. 623983:

Findings for Conditional Use Permit Approval – Section §126.0305

1. The proposed development will not adversely affect the applicable land use plan.

The proposed project would demolish the existing service station with convenience store which operates under an existing Conditional Use Permit, and construct a new gas station with a 2,400 square foot convenience store and 3,400 square foot canopy with six (6) fuel dispensers on a 0.42 acre site. The existing service station has a Type 20 Alcohol Sales License (off-premise consumption, beer and wine only), and the license would remain at this location.

The proposed project is in conformance with the commercial designation of the Clairemont Mesa Community Plan. The Plan designates this site as a portion of the Community Core and places it in the CPIOZ, Type B, recommending that a Planned Development Permit be obtained. Further, the proposed project would implement the Balboa Avenue Revitalization Action Program (RAP) by enhancing the aesthetics of the site and providing improved landscaping and pedestrian amenities. Specific project features include: an outdoor patio area, direct pedestrian access from the sidewalk to the building, the closure and consolidation of several driveways, and the installation of street trees with tree grates. These features are intended to help promote walkability along Balboa Avenue and establish pedestrian and bicycle connections to the adjacent residential neighborhoods. Therefore, the proposed project will not adversely affect the applicable land use plan.

2. The proposed development will not be detrimental to the public health, safety, and welfare.

The ARCO Balboa Avenue project would demolish the existing service station with convenience store which operates under an existing Conditional Use Permit, and construct a new gas station with a 2,400 square foot convenience store and 3,400 square foot canopy with six (6) fuel

dispensers on a 0.42 acre site. The existing service station has a Type 20 Alcohol Sales License (off-premise consumption, beer and wine only), and the license would remain at this location.

The conditions of approval for the project will require compliance with several operational constraints and development controls intended to assure the continued protection of public health, safety, and welfare. The development will also provide for the health, safety, and welfare of the customers and nearby residents by constructing all buildings in accordance with current construction standards and building codes. All of the construction plans associated with the project will be reviewed prior to issuance of a construction permit and inspected during construction to assure the project will meet or exceed all relevant and applicable building, electrical, mechanical, plumbing and fire codes.

3. The proposed development will comply to the maximum extent feasible with the regulations of the Land Development Code.

The ARCO Balboa Avenue project would demolish the existing service station with convenience store which operates under an existing Conditional Use Permit, and construct a new gas station with a 2,400 square foot convenience store and 3,400 square foot canopy with six (6) fuel dispensers on a 0.42 acre site. The existing service station has a Type 20 Alcohol Sales License (off-premise consumption, beer and wine only), and the license would remain at this location.

Part of the proposed project is to rezone the project site from CN-1-2 to CC-1-3. Although the Gas station has been in existence since 1966 under Use permits, the current proposal to demolish and rebuild the 24-hour service station and store requires rezoning. Once rezoned, the proposed use can be permitted under a Conditional Use Permit and the station has been designed to comply with all the regulations of the CC-1-3 zone. The station is proposed to operate on a 24-hour basis as it has since at least 1983.

4. The proposed use is appropriate at the proposed location.

The ARCO Balboa Avenue project would demolish the existing service station with convenience store which operates under an existing Conditional Use Permit, and construct a new gas station with a 2,400 square foot convenience store and 3,400 square foot canopy with six (6) fuel dispensers on a 0.42 acre site. The existing service station has a Type 20 Alcohol Sales License (off-premise consumption, beer and wine only), and the license would remain at this location.

Although the Gas station has been in existence since 1966 under use permits, the current proposal to demolish and rebuild the 24-hour service station and store requires rezoning of the property. Once rezoned, the proposed use can be permitted under a Conditional Use Permit and the station has been designed to comply with all the regulations of the CC-1-3 zone. The station is proposed to operate on a 24-hour basis as it has since at least 1983.

The proposed project would implement the Balboa Avenue Revitalization Action Program (RAP) by enhancing the aesthetics of the site and providing improved landscaping and pedestrian amenities. Specific project features include: an outdoor patio area, direct pedestrian access from the sidewalk to the building, the closure and consolidation of several driveways, and the installation of street trees with tree grates. These features are intended to help promote

walkability along Balboa Avenue and establish pedestrian and bicycle connections to the adjacent residential neighborhoods.

Site Development Permit - Section 126.0504

A. Findings for all Site Development Permits

1. The proposed development will not adversely affect the applicable land use plan.

The proposed project would demolish the existing service station with convenience store which operates under an existing Conditional Use Permit, and construct a new gas station with a 2,400 square foot convenience store and 3,400 square foot canopy with six (6) fuel dispensers on a 0.42 acre site. The existing service station has a Type 20 Alcohol Sales License (off-premise consumption, beer and wine only), and the license would remain at this location.

The proposed project is in conformance with the commercial designation of the Clairemont Mesa Community Plan. The Plan designates this site as a portion of the Community Core and places it in the CPIOZ, Type B, recommending that a Planned Development Permit be obtained. Further, the proposed project would implement the Balboa Avenue Revitalization Action Program (RAP) by enhancing the aesthetics of the site and providing improved landscaping and pedestrian amenities. Specific project features include: an outdoor patio area, direct pedestrian access from the sidewalk to the building, the closure and consolidation of several driveways, and the installation of street trees with tree grates. These features are intended to help promote walkability along Balboa Avenue and establish pedestrian and bicycle connections to the adjacent residential neighborhoods. Therefore, the proposed project will not adversely affect the applicable land use plan.

2. The proposed development will not be detrimental to the public health, safety, and welfare.

The ARCO Balboa Avenue project would demolish the existing service station with convenience store which operates under an existing Conditional Use Permit, and construct a new gas station with a 2,400 square foot convenience store and 3,400 square foot canopy with six (6) fuel dispensers on a 0.42 acre site. The existing service station has a Type 20 Alcohol Sales License (off-premise consumption, beer and wine only), and the license would remain at this location.

The conditions of approval for the project will require compliance with several operational constraints and development controls intended to assure the continued protection of public health, safety, and welfare. The development will also provide for the health, safety, and welfare of the customers and nearby residents by constructing all buildings in accordance with current construction standards and building codes. All of the construction plans associated with the project will be reviewed prior to issuance of a construction permit and inspected during construction to assure the project will meet or exceed all relevant and applicable building, electrical, mechanical, plumbing and fire codes.

3. The proposed development will comply with the applicable regulations of the Land Development Code.

The ARCO Balboa Avenue project would demolish the existing service station with convenience store which operates under an existing Conditional Use Permit, and construct a new gas station with a 2,400 square foot convenience store and 3,400 square foot canopy with six (6) fuel dispensers on a 0.42 acre site. The existing service station has a Type 20 Alcohol Sales License (off-premise consumption, beer and wine only), and the license would remain at this location.

Part of the proposed project is to rezone the project site from CN-1-2 to CC-1-3. Although the Gas station has been in existence since 1966 under Use permits, the current proposal to demolish and rebuild the 24-hour service station and store requires rezoning. Once rezoned, the proposed use can be permitted under a Conditional Use Permit and the station has been designed to comply with all the regulations of the CC-1-3 zone. The station is proposed to operate on a 24-hour basis as it has since at least 1983.

Planned Development Permit - Section 126.0604

A. Findings for all Planned Development Permits

1. The proposed development will not adversely affect the applicable land use plan.

The proposed project would demolish the existing service station with convenience store which operates under an existing Conditional Use Permit, and construct a new gas station with a 2,400 square foot convenience store and 3,400 square foot canopy with six (6) fuel dispensers on a 0.42 acre site. The existing service station has a Type 20 Alcohol Sales License (off-premise consumption, beer and wine only), and the license would remain at this location.

The proposed project is in conformance with the commercial designation of the Clairemont Mesa Community Plan. The Plan designates this site as a portion of the Community Core and places it in the CPIOZ, Type B, recommending that a Planned Development Permit be obtained. Further, the proposed project would implement the Balboa Avenue Revitalization Action Program (RAP) by enhancing the aesthetics of the site and providing improved landscaping and pedestrian amenities. Specific project features include: an outdoor patio area, direct pedestrian access from the sidewalk to the building, the closure and consolidation of several driveways, and the installation of street trees with tree grates. These features are intended to help promote walkability along Balboa Avenue and establish pedestrian and bicycle connections to the adjacent residential neighborhoods. Therefore, the proposed project will not adversely affect the applicable land use plan.

2. The proposed development will not be detrimental to the public health, safety, and welfare.

The ARCO Balboa Avenue project would demolish the existing service station with convenience store which operates under an existing Conditional Use Permit, and construct a new gas station with a 2,400 square foot convenience store and 3,400 square foot canopy with six (6) fuel

dispensers on a 0.42 acre site. The existing service station has a Type 20 Alcohol Sales License (off-premise consumption, beer and wine only), and the license would remain at this location.

The conditions of approval for the project will require compliance with several operational constraints and development controls intended to assure the continued protection of public health, safety, and welfare. The development will also provide for the health, safety, and welfare of the customers and nearby residents by constructing all buildings in accordance with current construction standards and building codes. All of the construction plans associated with the project will be reviewed prior to issuance of a construction permit and inspected during construction to assure the project will meet or exceed all relevant and applicable building, electrical, mechanical, plumbing and fire codes.

3. The proposed development will comply with the regulations of the Land Development Code.

The ARCO Balboa Avenue project would demolish the existing service station with convenience store which operates under an existing Conditional Use Permit, and construct a new gas station with a 2,400 square foot convenience store and 3,400 square foot canopy with six (6) fuel dispensers on a 0.42 acre site. The existing service station has a Type 20 Alcohol Sales License (off-premise consumption, beer and wine only), and the license would remain at this location.

Part of the proposed project is to rezone the project site from CN-1-2 to CC-1-3. Although the Gas station has been in existence since 1966 under Use permits, the current proposal to demolish and rebuild the 24-hour service station and store requires rezoning. Once rezoned, the proposed use can be permitted under a Conditional Use Permit and the station has been designed to comply with all the regulations of the CC-1-3 zone. The station is proposed to operate on a 24-hour basis as it has since at least 1983.

4. The proposed development, when considered as a whole, will be beneficial to the community.

The ARCO Balboa Avenue project would demolish the existing service station with convenience store which operates under an existing Conditional Use Permit, and construct a new gas station with a 2,400 square foot convenience store and 3,400 square foot canopy with six (6) fuel dispensers on a 0.42 acre site. The existing service station has a Type 20 Alcohol Sales License (off-premise consumption, beer and wine only), and the license would remain at this location.

The proposed project would implement the Balboa Avenue Revitalization Action Program (RAP) by enhancing the aesthetics of the site and providing improved landscaping and pedestrian amenities. Specific project features include: an outdoor patio area, direct pedestrian access from the sidewalk to the building, the closure and consolidation of several driveways, and the installation of street trees with tree grates. These features are intended to help promote walkability along Balboa Avenue and establish pedestrian and bicycle connections to the adjacent residential neighborhoods. Therefore when considered as a whole, the continued use of a service station with convenience store and alcohol sales, will be beneficial to the community.

5. Any proposed deviations pursuant to Section 126.0602(b)(1) are appropriate for this location and will result in a more desirable project than would be achieved if designed in strict conformance with the development regulations of the applicable zone.

The ARCO Balboa Avenue project would demolish the existing service station with convenience store which operates under an existing Conditional Use Permit, and construct a new gas station with a 2,400 square foot convenience store and 3,400 square foot canopy with six (6) fuel dispensers on a 0.42 acre site. The existing service station has a Type 20 Alcohol Sales License (off-premise consumption, beer and wine only), and the license would remain at this location.

Part of the proposed project is to rezone the project site from CN-1-2 to CC-1-3. Although the Gas station has been in existence since 1966 under use permits, the current proposal to demolish and rebuild the 24-hour service station and store requires this rezoning. Once rezoned, the proposed use can be permitted under a Conditional Use Permit and the station has been designed to comply with all the regulations of the CC-1-3 zone, with no deviations. The station is proposed to operate on a 24-hour basis as it has since at least 1983.

Neighborhood Use Permit - Section 126.0205

1. The proposed development will not adversely affect the applicable land use Plan.

The proposed project would demolish the existing service station with convenience store which operates under an existing Conditional Use Permit, and construct a new gas station with a 2,400 square foot convenience store and 3,400 square foot canopy with six (6) fuel dispensers on a 0.42 acre site. The existing service station has a Type 20 Alcohol Sales License (off-premise consumption, beer and wine only), and the license would remain at this location.

The proposed project is in conformance with the commercial designation of the Clairemont Mesa Community Plan. The Plan designates this site as a portion of the Community Core and places it in the CPIOZ, Type B, recommending that a Planned Development Permit be obtained. Further, the proposed project would implement the Balboa Avenue Revitalization Action Program (RAP) by enhancing the aesthetics of the site and providing improved landscaping and pedestrian amenities. Specific project features include: an outdoor patio area, direct pedestrian access from the sidewalk to the building, the closure and consolidation of several driveways, and the installation of street trees with tree grates. These features are intended to help promote walkability along Balboa Avenue and establish pedestrian and bicycle connections to the adjacent residential neighborhoods. Therefore, the proposed project will not adversely affect the applicable land use plan.

2. The proposed development will not be detrimental to the public health, safety, and welfare.

The ARCO Balboa Avenue project would demolish the existing service station with convenience store which operates under an existing Conditional Use Permit, and construct a new gas station with a 2,400 square foot convenience store and 3,400 square foot canopy with six (6) fuel dispensers on a 0.42 acre site. The existing service station has a Type 20 Alcohol Sales License (off-premise consumption, beer and wine only), and the license would remain at this location.

The conditions of approval for the project will require compliance with several operational constraints and development controls intended to assure the continued protection of public health, safety, and welfare. The development will also provide for the health, safety, and welfare of the customers and nearby residents by constructing all buildings in accordance with current construction standards and building codes. All of the construction plans associated with the project will be reviewed prior to issuance of a construction permit and inspected during construction to assure the project will meet or exceed all relevant and applicable building, electrical, mechanical, plumbing and fire codes.

3. The proposed development will comply with the applicable regulations of the Land Development Code.

The ARCO Balboa Avenue project would demolish the existing service station with convenience store which operates under an existing Conditional Use Permit, and construct a new gas station with a 2,400 square foot convenience store and 3,400 square foot canopy with six (6) fuel dispensers on a 0.42 acre site. The existing service station has a Type 20 Alcohol Sales License (off-premise consumption, beer and wine only), and the license would remain at this location.

Part of the proposed project is to rezone the project site from CN-1-2 to CC-1-3. Although the Gas station has been in existence since 1966 under Use permits, the current proposal to demolish and rebuild the 24-hour service station and store requires rezoning. Once rezoned, the proposed use can be permitted under a Conditional Use Permit and the station has been designed to comply with all the regulations of the CC-1-3 zone. The station is proposed to operate on a 24-hour basis as it has since at least 1983.

The above findings are supported by the minutes, maps and exhibits, all of which are herein incorporated by reference.

BE IT FURTHER RESOLVED, that the recommendation of the Planning Commission is sustained, and Conditional Use Permit (CUP) No. 586793, Site Development Permit (SDP) No. 586794, Planned Development Permit (PDP) No. 840713, and Neighborhood Use Permit (NUP) No. 623983, is granted to Seven Clairemont Properties, Owner and BP West Coast Products,

Permittee, under the terms and conditions set forth in the permit attached hereto and made a part hereof.

APPROVED: JAN GOLDSMITH, City Attorney

By _____
Nina Fain
Deputy City Attorney

ATTY/SEC. INITIALS
DATE
Or.Dept:Clerk
R-XXXX
Reviewed by Jeannette Temple

Temple, Jeannette

From: Eric and Brooke Peterson [thepetes@hotmail.com]
Sent: Tuesday, February 08, 2011 1:54 PM
To: Temple, Jeannette
Subject: AGC-0014 San Diego - Project No. 163653

Jeanette,

We do not yet have approved minutes as this item was heard at our January meeting and we won't be voting approval of the minutes until our February meeting. I can provide you with the motion and vote though.

Motion: to approve the Arco-Balboa project on the condition that the landscaping in the planters/boxes along Mt. Abernathy includes a minimum of medium-sized trees and not just shrubs. Motion made by Scott Wentworth, seconded by Donald Steele.

Vote: 11-0-0, motion passed.

Please let me know if you need anything further from me.

Thanks.

Brooke Peterson, CCPG Chair

CITY OF SAN DIEGO
M E M O R A N D U M

DATE: 4/1/2011
TO: Sgt. Linda Griffin, Vice Unit
FROM: Joe Dalton, Crime Analysis
SUBJECT: ARCO

Search Criteria:

6130 Balboa Av.
Jan. 1, 2010 to Dec. 31, 2010

Request Summary:

The owners of ARCO located at 6130 Balboa Av. have a type 20 (Off-Sale Beer&Wine) ABC license. Supply ABC Board required statistics and any relevant supplemental information to assist in the evaluation of this application.

Results Summary:

Calls for Service - There were 26 service calls to the addresses for January 1, 2010 to December 31, 2010 with an out of service time of 12.5 hours.

MOI11 - There were 2 arrests at the location (one of the two was for 647(ff) and 37 arrests within a 0.2-mile radius from the location in 2010.

CCS50I - There was 1 crime case at the location and 96 crime cases within a 0.2-mile radius from the location in 2010.

ABC Report - The requested address is located in federal census tract 85.07 based on ARJIS geographical coding. I reviewed the static ABC report for 2010. The report shows that census tract 85.07 has a percent total crime rate of 138.9%. Please note that anything 120% or above is considered a high crime area. I also pulled the alcohol related arrests and citations for census tracts within the city and found that census tract 85.07 had 47 in 2010.

MAP - The attached map displays the location of current ABC licenses within federal census tract 85.07.

If you have any questions regarding this report, call me at 531-1536.

Joe Dalton
Crime Analyst

Calls For Service

ATTACHMENT 12

Address Information: 6130 -6130 BALBOA*

Date Range: 01/01/2010 - 12/31/2010 , 00:00 - 23:59 Hours

No Crime Type, Disposition or Priority specified.

Sorted by: Crime Type asc

4/1/2011

INCIDENT #	DATE/TIME	LOCATION	TYPE	DIS	BEAT	OST
P10010021209	Mon 01/11/2010 10:13	6130 BALBOA AV	1150	K	111	0.12
P10050045528	Fri 05/21/2010 15:31	6130 BALBOA AV	1150	K	111	0.08
P10040013446	Wed 04/7/2010 11:56	6130 BALBOA AV	211C	K	111	1.67
P10040053110	Mon 04/26/2010 15:45	6130 BALBOA AV	415	K	111	0.23
P10040053210	Mon 04/26/2010 16:36	6130 BALBOA AV	415	A	111	2.70
P10070052958	Sun 07/25/2010 12:38	8130 BALBOA AV	415	K	111	1.14
P10090008845	Sat 09/4/2010 23:52	6130 BALBOA AV	415V	CAN	111	
P10070014064	Wed 07/7/2010 10:00	6130 BALBOA AV	488R	(R)	111	1.92
P10090048845	Thu 09/23/2010 22:39	6130 BALBOA AV	488R THIS ONE NO REPORT ON	K	111	0.05
P10020015637	Mon 02/8/2010 11:07	6130 BALBOA AV	911	CAN	111	
P10010022001	Mon 01/11/2010 17:31	6130 BALBOA AV	911P	K	111	0.54
P10020031138	Mon 02/15/2010 17:11	6130 BALBOA AV	911P	K	111	0.17
P10020038686	Fri 02/19/2010 6:03	6130 BALBOA AV	911P	K	111	0.19
P10030014696	Mon 03/8/2010 6:31	6130 BALBOA AV	911P	U	111	0.30
P10030029666	Mon 03/15/2010 6:41	6130 BALBOA AV	911P	K	111	0.28
P10030041909	Sat 03/20/2010 16:09	6130 BALBOA AV	911P	K	111	0.13
P10030045195	Mon 03/22/2010 6:28	6130 BALBOA AV	911P	K	111	0.35
P10030051424	Thu 03/25/2010 6:36	6130 BALBOA AV	911P	K	111	0.22
P10040036713	Sun 04/18/2010 13:50	6130 BALBOA AV	911P	K	111	0.45
P10060041777	Sun 06/20/2010 12:31	6130 BALBOA AV	911P	K	111	0.47
P10070029351	Wed 07/14/2010 14:33	6130 BALBOA AV	911P	U	111	0.25
P10080022606	Wed 08/11/2010 14:19	6130 BALBOA AV	911P	K	111	0.35
P10080033632	Mon 08/16/2010 17:24	6130 BALBOA AV	911P	K	111	0.24
P10080034957	Tue 08/17/2010 9:32	6130 BALBOA AV	911P	K	111	0.30
P10080035014	Tue 08/17/2010 10:06	6130 BALBOA AV	911P	K	111	0.18
P10080043823	Sat 08/21/2010 11:07	6130 BALBOA AV	911P	K	111	0.21

TRAFFIC STOPS
ROBBERY CASES
DISTURBANCE
THEFT REPORT
NO REPORT ON

THEY
NEED TO
TAKE OUT
THIS PAYPHONE

Total # of Calls = 26

Total Out of Service Time = 12.54

**San Diego Police Department
Alcohol Arrests & Cites - By Federal Census Tract
(Excluding Unknown Tracts)
January to December 2010**

<u>2000 Census Tract</u>	<u>Alcohol Violations</u>	<u>Tract Total as % of Tract Average</u>
008329	48	77.7%
008330	10	16.2%
008331	8	13.0%
008332	3	4.9%
008333	14	22.7%
008334	8	13.0%
008335	18	29.1%
008336	2	3.2%
008337	13	21.0%
008338	12	19.4%
008339	20	32.4%
008340	11	17.8%
008341	14	22.7%
008342	16	25.9%
008343	5	8.1%
008344	12	19.4%
008345	7	11.3%
008346	10	16.2%
008347	17	27.5%
008348	8	13.0%
008349	28	45.3%
008350	30	48.6%
008351	11	17.8%
008352	17	27.5%
008353	5	8.1%
008354	12	19.4%
008355	25	40.5%
008356	8	13.0%
008357	33	53.4%
008358	50	81.0%
008359	12	19.4%
008360	23	37.2%
008501	17	27.5%
008502	60	97.1%
008503	43	69.6%
008504	39	63.1%
008505	46	74.5%
008506	22	35.6%
008507	47	76.1%
008509	50	81.0%
008510	23	37.2%
008511	166	268.8%
008512	13	21.0%
008513	6	9.7%
008600	56	90.7%
008701	11	17.8%
008702	43	69.6%
008800	47	76.1%

Alcohol And Beverage Control Licenses (San Diego) 6130 Balboa Av. - 0.2 Mile Radius

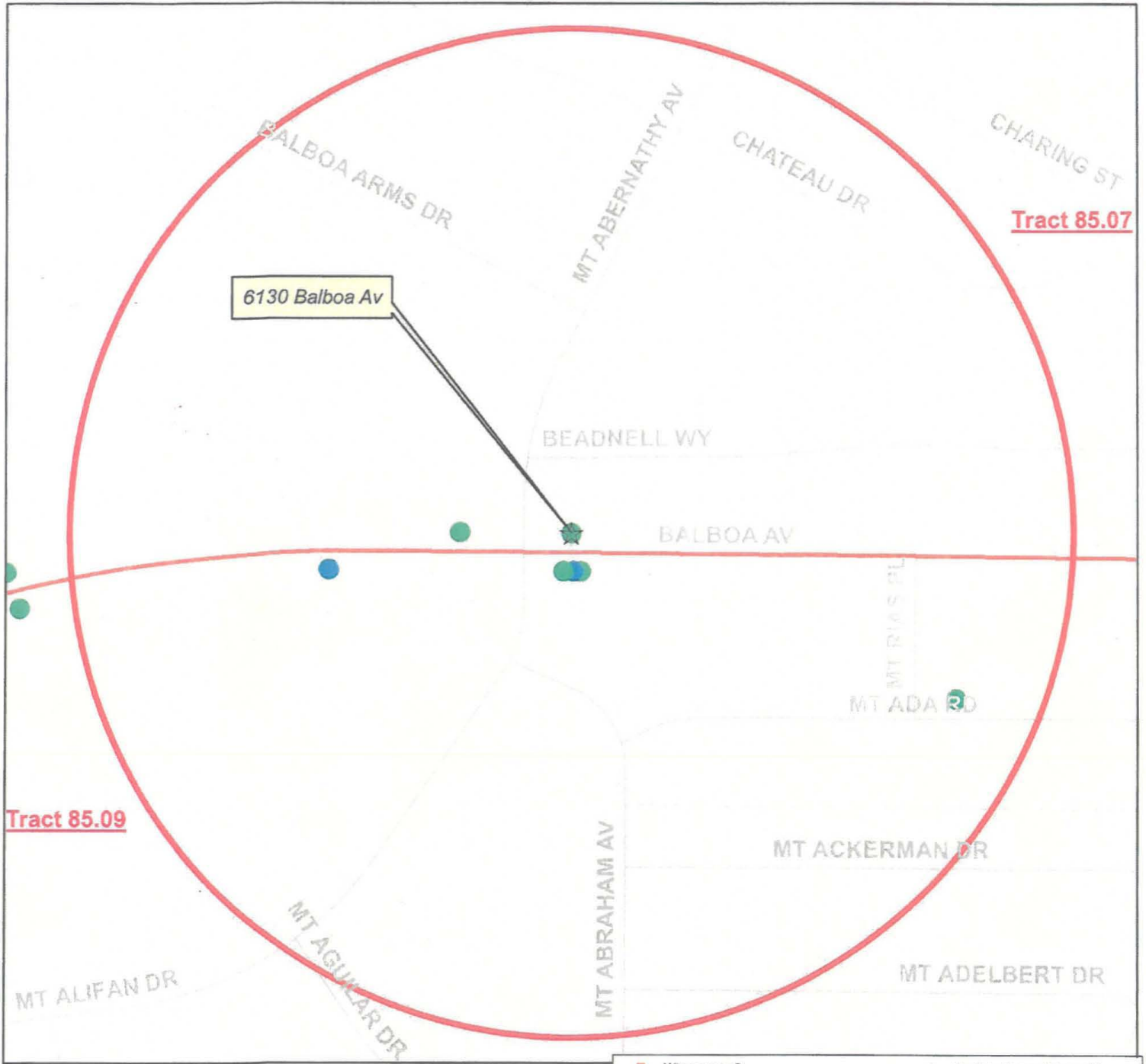

SanGIS San Diego Police Department
Crime Analysis Unit
February 2010

THIS MAP IS PROVIDED WITHOUT WARRANTY OF ANY KIND, EITHER EXPRESS OR IMPLIED, INCLUDING BUT NOT LIMITED TO, THE IMPLIED WARRANTIES OF MERCHANTABILITY AND FITNESS FOR A PARTICULAR PURPOSE. Copyright SanGIS. All Rights Reserved.

This product may contain information from the SANDAG Regional Information System that cannot be reproduced without the written permission of SANDAG.

This product may contain information that has been reproduced with permission granted by Thomas Brothers Maps.

Note: Hot spot layer is extremely geographically limited in order to show only the very worst overconcentrations of liquor licenses. The intent is to indicate areas where the City Plan permits high concentration, and areas where concentrations have occurred independent of planning action.



■ Winegrower 2	▲ On Sale General Plane 46
● Off Sale Beer & Wine 20	▲ On Sale Large Boat 56
● Off Sale General 21	● On Sale Special 57
● On Sale Beer 40	● Caterer 58
● On Sale Beer & Wine Eating Place 41	▲ On Sale General Dockside 62
● On Sale Beer & Wine Public Premise 42	● On Sale Theater 64
▲ On Sale Beer Boat 44	● Controlled Cabinate 66
▲ On Sale Beer & Wine Boat 45	● Bed & Breakfast 67
● On Sale General Eating Place 41	● Portable Bar 68
● On Sale General Public Premise 42	● On Sale General Restrictive 70
▲ On Sale General Club 50	● On Sale General Brew Pub 75
▲ Club 51	▲ On Sale General Museum 76
▲ Vets Club 52	● Event Permit 77
▲ On Sale General Boat 45	

02/07/2011
10:05:19

SAN DIEGO
STATIC ABC REPORT
PART 1 CRIME AND PART 2 ARREST REPORT
FROM JANUARY, 2010 TO DECEMBER, 2010
REPORTED BY=CENTRACT 008507

B98S323R
PAGE 187

CRIME TYPES	CRIME TOTALS
CRIMINAL HOMICIDE	0
FORCIBLE RAPE	1
ROBBERY	9
AGGRAVATED ASSAULT	13
BURGLARY	45
LARCENY	122
MOTOR VEHICLE THEFT	45
ARSON	0

TOTAL PART I CRIME :	235

ARREST TYPES	ARREST TOTALS
SIMPLE ASSAULT	7
OTHER PART TWO CRIMES	50
CHILD AND FAMILY	5
DEADLY WEAPONS	4
EMBEZZLEMENT	0
FRAUD	1
GAMBLING	0
MALICIOUS MISCHIEF	3
NARCOTICS	21
SEX CRIMES	4
FORGERY	1
OTHER NON-CRIMINAL	9

TOTAL PART II ARREST:	105

CENTRACT TOTAL = PART I CRIME + PART II ARREST	340
CENTRACT AVE. (AGENCY / 301 CENTRACT)	244.7
AGENCY WIDE TOTAL = PART I CRIME + PART II ARREST	73656
CENTRACT TOTAL AS % OF CENTRACT AVERAGE (120 IS CONSIDERED HIGH CRIME AREA)	138.9

ARCO Balboa Avenue - Project No. 163653

Seven Clairemont Properties
Michael Bartell
Managing Partner
4238 Balboa Avenue, San Diego, CA 92117.

BP West Coast Products, LLC
Jeff Cary
4 Centerpointe Drive
La Palma, CA 90623

Franchisee
Ed Haddad
29848 Live OakCanyon Road
Redlands, CA. 92373

DEVELOPMENT SERVICES DEPARTMENT
PROJECT CHRONOLOGY
 ARCO BALBOA AVENUE - PROJECT NO. 163653

Date	Action	Description	City Review Time (Calendar Days)	Applicant Response
1/9/09	First Submittal	Project Deemed Complete	-	-
2/2/09	First Assessment Letter	Furlough and City Holidays	24 days	
7/6/09	Second Submittal			5 months, 2 days
8/13/09	Second Assessment Letter		1 month, 7 days	
10/1/09	Third Submittal			1 month, 18 days
10/30/09	Third Assessment Letter		29 days	
12/11/09	Fourth Submittal			1 month, 12 days
1/13/10	Fourth Assessment Letter		1 month, 2 days	
1/15/10	Third Submittal			2 days
2/11/10	Third Assessment Letter		27days	
3/11/11		Worked out Hazmat Issues with County		1 year, 1 month
4/28/11	Hearing-Continued	CA Advice to prepare Neg Dec	48 days	
5/9/11	Draft ND out		11 days	
6/23/11	Hearing-PC		1 month, 14 days	
TOTAL STAFF TIME		(Does not exclude City Holidays or weekends)	8 months, 11 days	
TOTAL APPLICANT TIME		(Does not exclude City Holidays or weekends)		1 year, 9 months, 3 days
TOTAL PROJECT RUNNING TIME		From Deemed Complete to Hearing	2 years, 5 months, 14 days	