



THE CITY OF SAN DIEGO  
**REPORT TO THE PLANNING COMMISSION**

**DATE ISSUED:** March 22, 2012 **REPORT NO. PC-12-022**

**ATTENTION:** Planning Commission, Agenda of March 29, 2012

**SUBJECT:** AT&T MOBILITY - SIXTH AVENUE LTE  
PROJECT NO. 225054, PROCESS FOUR

**OWNER/  
APPLICANT:** BELLEFONTAINE CONDO OWNERSHIP ASSOCIATION  
AT&T MOBILITY

**SUMMARY**

**Issue(s):** Should the Planning Commission approve a modification to an existing Wireless Communication Facility (WCF) at 2400 Sixth Avenue (Attachment 1) in the Uptown Community Plan?

**Staff Recommendation:**

1. **APPROVE** Site Development Permit (SDP) No. 825696 and;
2. **APPROVE** Conditional Use Permit (CUP) No. 825695.

**Community Planning Group Recommendation:** On April 5, 2011, the Uptown Planners voted 16-0-0 to support the AT&T Mobility Sixth Avenue LTE project (Attachment 10).

**Environmental Review:** The project is categorically exempt from the California Environmental Quality Act (CEQA) pursuant to CEQA State Guidelines, Section 15301 (Existing Facilities) and 15303 (New Construction). This project is not pending an appeal of the environmental determination. The environmental exemption determination for this project was made on March 1, 2011, and the opportunity to appeal that determination ended March 15, 2011 (Attachment 12).

**Fiscal Impact Statement:** None with this action. All costs associated with the processing of this project are paid from a deposit account maintained by the applicant.

**Code Enforcement Impact:** None with this action.

**Housing Impact Statement:** None with this action.

## **BACKGROUND**

The project site is located at 2400 Sixth Avenue (Attachment 3) in the Mid-Cities Community Planned District (MCCPD) MR-800B zone of the Uptown Community Planning area (Attachment 2). This is an existing project that AT&T is proposing to upgrade for their on-going LTE (Long Term Evolution) 4g technology. AT&T Mobility recently received an approval from the Planning Commission on October 7, 2010 for a Site Development Permit and a Conditional Use Permit to continue the use of this Wireless Communication Facility (WCF) after it expired on November 16, 1999.

The project consists of three sectors of antennas façade mounted onto a 133-foot tall condominium complex. A total of sixteen (16) antennas will be owned and operated by AT&T Mobility as a result of this proposal. There will also be two additional equipment cabinets located inside the existing equipment platform, with no exterior changes.

Cricket Wireless is also located on this building, as well as equipment left behind by Metricom, who is no longer in business.

The property is located adjacent to commercial use on the north, residential uses to the west and north and Balboa Park to the west. An application for a Conditional Use Permit (CUP) and a Site Development Permit (SDP) has been submitted by AT&T Mobility to amend the previous approvals.

## **DISCUSSION**

**Project Description** – AT&T's modification for this project location involves relocating the existing antennas to the upper portion of the building on three sides of the condominium. Additionally, one new sector of antennas will be added to the top of the roof behind a new cupola constructed of Fiberglass Reinforced Panels (FRP). The existing equipment associated with this WCF will continue to operate on the north elevation behind a raised platform with minimal visibility.

More specifically, this project includes the removal of a total of three screen boxes on the existing condominium and restoring the facade back to its original condition. The existing antennas on the south sector will be replaced and relocated to a new FRP screen box on the south elevation that will align with the top of the structure and will be painted and textured to match the existing condominium. The antennas located on the north and west elevations will be relocated inside a four-sided FRP box designed to wrap around the structure as illustrated on the photosimulation (Attachment 8). In doing so, the antennas and all associated components will be concealed appropriately with minimal impacts to the aesthetics of the structure. Lastly, AT&T will also be adding a new sector of antennas on the roof behind an 8'-3" high cupola facing the east elevation. The four-sided cupola will be painted and textured to match the existing

condominium. As designed, one sector of antenna is located within the rear yard setback and the associated equipment enclosure exceeds the 250-square foot limit (Municipal Code Section 141.0420(g)(3)). As indicated in the Mid Cities Community Planned District Ordinance, these proposed deviations require an SDP (Attachment 6).

**Wireless Communication Facility(WCF) Regulation** - A CUP is required per City of San Diego Municipal Code Section 141.0420(f)(2) which states that a Conditional Use Permit is required for all Wireless Communication Facilities in residential zones. The project is located on an existing residential use within the MR-800B zone. Additionally, a Site Development Permit is being processed to continue to allow the WCF to remain within the required rear yard setback and to exceed the maximum equipment area (Per LDC Section 141.0420(g)(3)) of 250-square feet. After thoroughly reviewing this site location and the proposed deviations, staff has determined that this WCF is appropriate and complies with LDC section 141.0420.

**Community Plan Analysis** - The project location has been designated for residential use in the Uptown Community Land Use Plan (Attachment 2). The Uptown Community Plan does not contain specific policies on wireless communication facility development.

**Council Policy 600-43** - The guidelines establish a hierarchy from the most preferred locations (Preference 1) to the least preferred location (Preference 4) for WCFs. The project is proposed within a Preference 4 location according to Council Policy 600-43, which categorizes WCF's according to land use in which they are located. In this case, the project is located on a residential use, and is considered to be the least preferable location according to the Council Policy. The applicant is required to submit a site justification explaining why a Preference 4 site was selected over any lower Preference level sites. Due to the topography of the area and the other existing tall buildings, AT&T has elected to remain at this location to provide upgraded coverage for the community and for those passing through.

**General Plan** - The General Plan, Section UD-A.15, states that WCF's should be concealed in existing structures when possible, or otherwise use camouflage and screening techniques to hide or blend the facilities into the surrounding area. The design of the facility is to be aesthetically pleasing and respectful of the neighborhood context. The design consists of FRP boxes that fully conceal the antennas and will be painted and textured to match the existing condominium. The equipment associated with this project is located on the second story, and has been designed to appear as part of the building. Therefore, staff has determined that the proposed WCF has been designed to the extent possible to be integrated and respectful to the neighborhood context.

**Conclusion** - The proposed amendment has been determined by staff to be consistent with the purpose and intent of the applicable development regulations of the San Diego Municipal Code, which includes the development regulations from the MCCPD MR-800B zone and the Wireless Communication Facilities Regulations Section 141.0420. Staff supports the Uptown Planners' recommendation to support the modifications proposed by AT&T Mobility. The equipment, as stated earlier in the report is located on the second story, and has been designed to appear as part of the building with minimal visibility. The project complies with all applicable zoning requirements with the exception of the requested rear yard setback and equipment size deviation which requires a SDP. The WCF has been determined to be consistent with the General Plan and

the Uptown Community Plan. Staff recommends that the Planning Commission approve Site Development Permit No. 825696 and Conditional Use Permit No. 825695.

**ALTERNATIVES**

1. **Approve** Site Development Permit No. 825696 and Conditional Use Permit No. 825695, **with modifications.**
2. **Deny** Site Development Permit No. 825696 and Conditional Use Permit No. 825695, **if the Planning Commission makes written findings based on substantial evidence that the approval is not authorized by state or local zoning law.**

Respectfully submitted,



---

Mike Westlake  
Program Manager  
Development Services Department

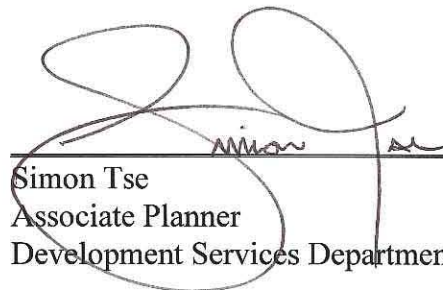

---

Simon Tse  
Associate Planner  
Development Services Department

Attachments:

1. Aerial Photograph
2. Community Plan Land Use Map
3. Project Location Map
4. Project Data Sheet
5. Draft Permit Resolution with Findings
6. Draft Permit with Conditions
7. Project Plan
8. Photosimulation(s)
9. Photosurvey
10. Community Planning Group Recommendation
11. Ownership Disclosure Statement
12. Notice of Exemption
13. Public Notice of Planning Commission Hearing
14. Project Chronology





# Aerial Photo

**AT&T Mobility Sixth Avenue LTE - Project No. 225054**  
**2400 Sixth Avenue, San Diego, CA 92101**

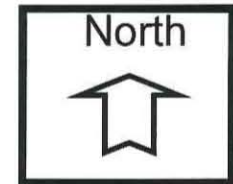



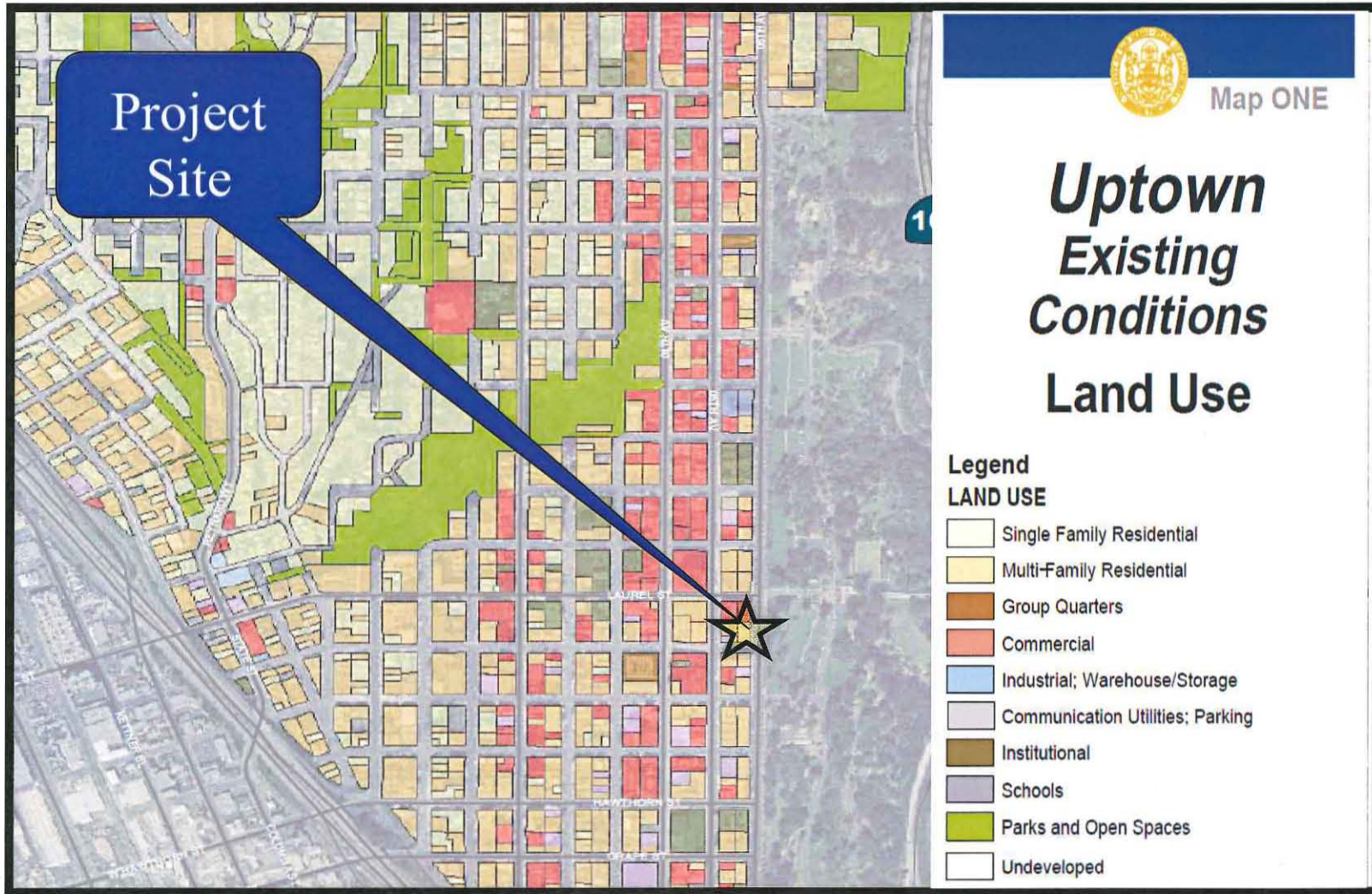

# Community Land Use Map (Uptown)

**AT&T Mobility Sixth Avenue LTE - Project No. 225054**  
**2400 Sixth Avenue, San Diego, CA 92101**

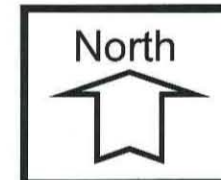

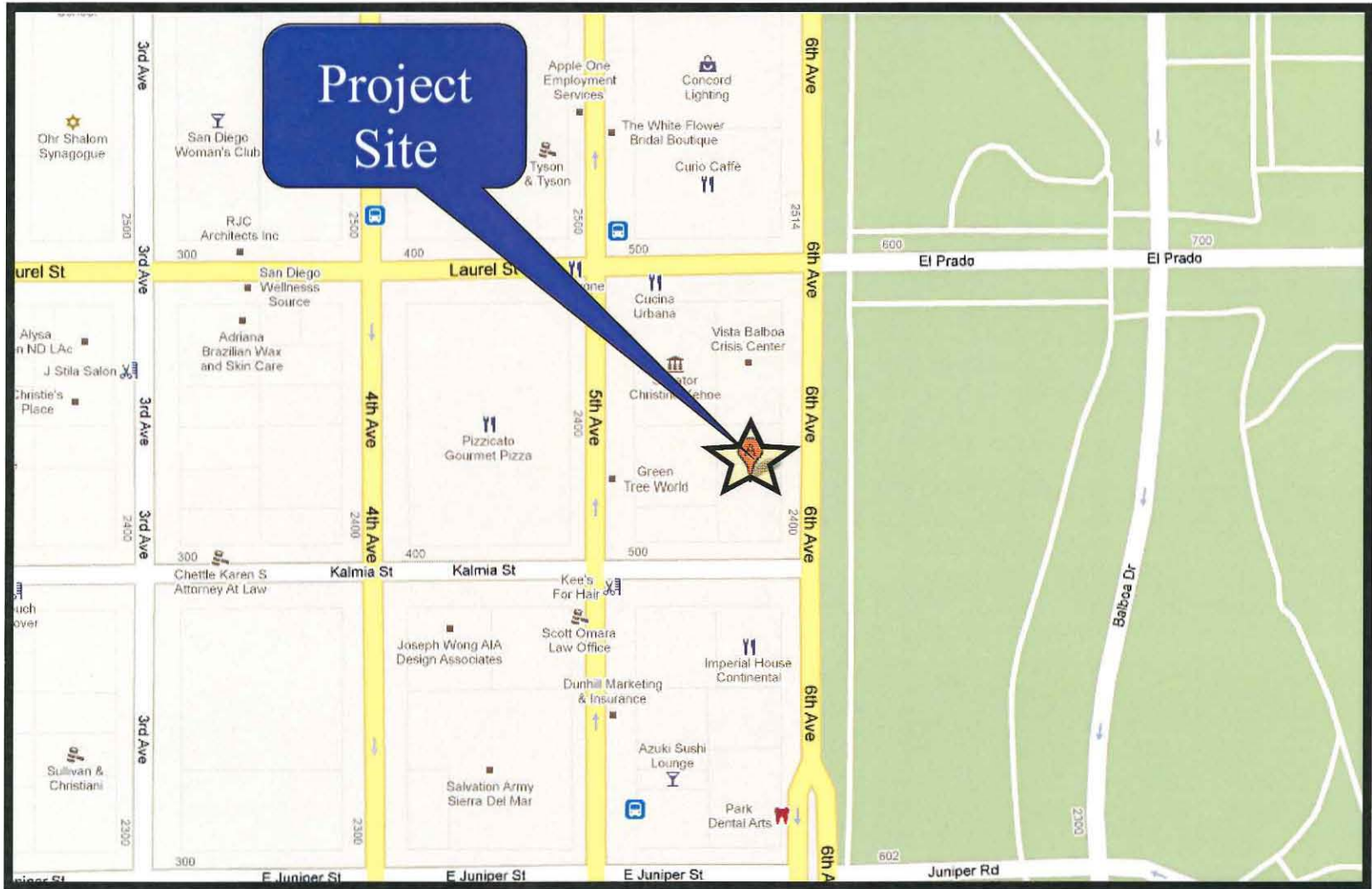

# Project Location Map

**AT&T Mobility Sixth Avenue LTE - Project No. 225054**  
**2400 Sixth Avenue, San Diego, CA 92101**

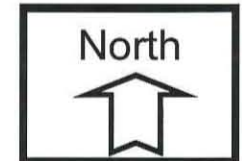

## PROJECT DATA SHEET

<b>PROJECT NAME:</b>	AT&T Mobility Sixth Avenue LTE	
<b>PROJECT DESCRIPTION:</b>	A modification to an existing Wireless Communication Facility (WCF) consisting of sixteen (16) panel antennas. Twelve (12) antennas behind Fiberglass Reinforced Panel (FRP) screen walls (relocated to the top of the building), painted and textured to match. Four (4) antennas behind a new rooftop FRP screen box painted and textured to match. The equipment associated with the project is located on the second story above the parking garage, and will not be visible to the public	
<b>COMMUNITY PLAN AREA:</b>	Uptown	
<b>DISCRETIONARY ACTIONS:</b>	Site Development Permit & Conditional Use Permit	
<b>COMMUNITY PLAN LAND USE DESIGNATION:</b>	Multi-Residential	
<b><u>(MCCPD MR-800 Zone) ZONING INFORMATION:</u></b>		
<b>ZONE:</b> MCCPD-MR-800B <b>HEIGHT LIMIT:</b> 60 feet (bldg. above encl. parking) <b>FRONT SETBACK:</b> 10 feet. <b>INTERIOR SIDE SETBACK:</b> 6 feet. <b>STREETSIDE SETBACK:</b> 6 feet. <b>REAR SETBACK:</b> 15 feet		
<b>ADJACENT PROPERTIES:</b>	<b>LAND USE DESIGNATION &amp; ZONE</b>	<b>EXISTING LAND USE</b>
<b>NORTH:</b>	Multi-family Residential MCCPD-MR-800B	Residential
<b>SOUTH:</b>	Multi-family Residential MCCPD-MR-800B	Mixed-Use (Residential and Commercial)
<b>EAST:</b>	Unzoned	Balboa Park
<b>WEST:</b>	Commercial and Mixed Use MCCPD-CN-1A	Residential
<b>DEVIATIONS OR VARIANCES REQUESTED:</b>	AT&T Mobility is requesting a setback deviation to continue to operate their WCF within the rear yard setback. Additionally, an equipment size deviation is being requested to exceed the maximum 250-sq ft (275-sq ft) as allowed per Land Development Code Section 141.0420(g)(3).	



<b>COMMUNITY PLANNING GROUP RECOMMENDATION:</b>	On April 5, 2011, the Uptown Planners voted 16-0-0 to support the AT&T Mobility Sixth Avenue LTE project (Attachment 10).
---	---

**PLANNING COMMISSION  
RESOLUTION NO.  
SITE DEVELOPMENT PERMIT NO. 825696  
CONDITIONAL USE PERMIT NO. 825695  
AT&T MOBILITY SIXTH AVENUE LTE  
PTS NO. 225054**

WHEREAS, **BELLEFONTAINE CONDO OWNERS ASSOCIATION**, Owner, and **AT&T MOBILITY**, Permittee, filed an application with the City of San Diego for a permit to modify an existing Wireless Communication Facility (WCF) consisting of sixteen (16) panel antennas all completely concealed behind Fiberglass Reinforced Panel (FRP) features, painted and textured to match the existing building. The equipment associated with this modification is located on the second story above the parking garage and will not be visible to the public as described in and by reference to the approved Exhibits "A" and corresponding conditions of approval for the associated Site Development Permit No. 825896 and Conditional Use Permit No. 825895;

WHEREAS, the project site is located at 2400 Sixth Avenue, San Diego, CA 92101, in the MCCPD-MR-800B zone of the Uptown Community Plan;

WHEREAS, the project site is legally described as Lots G, H, I in block 282 of Horton's addition, in the City San Diego, State of California, according to the Map thereof filed July 21, 1871, in deed book 13, page 522, in the office of the County Recorder of San Diego County;

WHEREAS, on March 29, 2012, the Planning Commission of the City of San Diego considered Site Development Permit No. 825896 and Conditional Use Permit No. 825895 pursuant to the Land Development Code of the City of San Diego; NOW, THEREFORE,

WHEREAS, on March 1, 2011, the City of San Diego, as Lead Agency, through the Development Services Department, made and issued an Environmental Determination that the project is exempt from the California Environmental Quality Act (CEQA) (Public Resources Code section 21000 et. seq.) under CEQA Guideline Section 15301 (existing facilities) and 15303 (new construction) and there was no appeal of the Environmental Determination filed within the time period provided by San Diego Municipal Code Section 112.0520;

BE IT RESOLVED by the Planning Commission of the City of San Diego as follows:

That the Planning Commission adopts the following written Findings, dated March 29, 2012.

**FINDINGS:**

**Findings for a Conditional Use Permit Approval – Section §126.0305**

- 1. The proposed development will not adversely affect the applicable land use plan.** The Uptown Community Plan does not address wireless communication facilities as a specific land use. However, the City of San Diego General Plan addresses these facilities, recommending that they minimize visual impact by concealing the wireless facilities in existing structures when possible, designing facilities to be aesthetically pleasing and respectful to the neighborhood context and concealing mechanical equipment and devices associated with wireless facilities in

underground vaults or unobtrusive structures. Pursuant to the San Diego Land Development Code, WCF's are permitted in all zones citywide with the appropriate permit process. WCF's are separately regulated uses, which have limitations or require compliance with conditions in order to minimize potential impacts. The intent of the regulations is to camouflage facilities from public view. All sixteen panel antennas will be completely concealed behind new Fiberglass Reinforced Panel (FRP) features designed to match the color and texture of the condominium. The associated equipment modification is concealed on the second story, above the parking garage and will not be visible to the public. As a result, the proposed development would not adversely affect the Uptown Community Plan or the City of San Diego General Plan and Progress Guide.

**2. The proposed development will not be detrimental to the public health, safety, and welfare.** The Telecommunication Act of 1996 preempts local governments from regulating the "placement, construction and modification of wireless communication facilities on the basis of the environmental effects of Radio Frequency (RF) emissions to the extent that such facilities comply with the Federal Communication Commission's (FCC) standards for such emissions." The proposed project would be consistent with the FCC's regulations for wireless facilities. AT&T Mobility submitted an RF Report to staff demonstrating compliance with the required FCC regulations. Therefore, based on the above, the project would not result in any significant health or safety risks to the surrounding area within matters of City's jurisdiction.

**3. The proposed development will comply to the maximum extent feasible with the regulations of the Land Development Code;** and The modified WCF for Sector D is located within the required MCCPD-MR-800B side yard setback and therefore requires a deviation to the setback requirements. AT&T is also requesting a deviation to maintain their equipment facility that exceeds the 250-square foot limit per Land Development Code (LDC) section 141.0420(g)(3). The project is also located on an existing condominium and as such, a Conditional Use Permit is required. As a result of these deviations, the project requires a Site Development Permit and a Conditional Use Permit, consolidated Process 4, Planning Commission decision, appealable to City Council. The Wireless Communication Regulations requires integration, and the project design complies with this section of the code by placing the antennas inside the stealth FRP boxes. Again, the equipment associated with this project is located in the required side yard setbacks and exceeds the maximum 250-square feet limit; however, it is also directly above the parking garage entrance and as designed will not be visible to the public. Staff can support the proposed deviations considering the existing equipment location would result in minimal impacts to the existing residential use and the equipment enclosure has been designed to comply with the WCF regulations. Besides the proposed deviations, the project will comply with the applicable regulations of the Land Development Code.

**4. The proposed use is appropriate at the proposed location.** Typically, the City of San Diego encourages wireless carriers to locate on non-residential properties. However, in this situation the existing WCF is located on a condominium that AT&T to improve. The improvements include the relocation of twelve existing antennas to the upper most portion of the condominium and concealed inside FRP screens, painted and textured to match the building. A new sector of antenna will also be concealed on the roof behind a cupola. In doing so, these antennas will be screened and will minimize all visual impacts to and from the site. Therefore, this project has been designed to comply with Section 141.0420 and the Wireless Communication



Facility Guidelines. Additionally, this site will continue to provide AT&T's wireless coverage to the roadways, homes, and business located in the area. Thus, the proposed use is appropriate for this site.

### **Findings for a Site Development Permit - Section 126.0504**

**1. The proposed development will not adversely affect the applicable land use plan;** The Uptown Community Plan does not address wireless communication facilities as a specific land use. However, the City of San Diego General Plan addresses these facilities, recommending that they minimize visual impact by concealing the wireless facilities in existing structures when possible, designing facilities to be aesthetically pleasing and respectful to the neighborhood context and concealing mechanical equipment and devices associated with wireless facilities in underground vaults or unobtrusive structures. Pursuant to the San Diego Land Development Code, wireless communication facilities are permitted in all zones citywide with the appropriate permit process. Wireless communication facilities are separately regulated uses, which have limitations or require compliance with conditions in order to minimize potential impacts. The intent of the regulations is to camouflage facilities from public view. All sixteen panel antennas will be completely concealed behind Fiberglass Reinforced Panel (FRP) features designed to match the color and texture of the condominium. The associated equipment modification is concealed on the second story, above the parking garage and will not be visible to the public. As a result, the proposed development would not adversely affect the Uptown Community Plan or the City of San Diego General Plan and Progress Guide.

**2. The proposed development will not be detrimental to the public health, safety, and welfare; and** The Telecommunication Act of 1996 preempts local governments from regulating the "placement, construction and modification of wireless communication facilities on the basis of the environmental effects of Radio Frequency (RF) emissions to the extent that such facilities comply with the Federal Communication Commission's (FCC) standards for such emissions." The proposed project would be consistent with the FCC's regulations for wireless facilities. AT&T Mobility submitted an RF Report to staff demonstrating compliance with the required FCC regulations. Therefore, based on the above, the project would not result in any significant health or safety risks to the surrounding area within matters of City's jurisdiction.

**3. The proposed development will comply with the applicable regulations of the Land Development Code.** The proposed WCF modification for Sector D is located within the required MCCPD-MR-800B side yard setback and therefore requires a deviation to the setback requirements. AT&T is also requesting a deviation to maintain their equipment facility that exceeds the 250-square foot limit per Land Development Code (LDC) section 141.0420(g)(3). The project is also located on an existing condominium and as such, a Conditional Use Permit is required. As a result of these deviations, the project requires a Site Development Permit and a Conditional Use Permit, consolidated Process 4, Planning Commission decision, appealable to City Council. The Wireless Communication Regulations requires integration, and the project design complies with this section of the code by placing the antennas inside the stealth FRP boxes. Again, the equipment associated with this project is located in the required side yard setbacks and exceeds the maximum 250-square feet limit; however, it is also directly above the parking garage entrance and as designed will not be visible to the public. Staff can support the proposed deviations considering the existing equipment location would result in minimal impacts to the existing residential use and the equipment enclosure has been designed to comply with the

WCF regulations. Besides the proposed deviations, the project will comply with the applicable regulations of the Land Development Code.

**4. Conformance With Community Plan and Design Manuals.** The proposed use and project design meet the purpose and intent of the Mid-City Communities Planned District (Section 1512.0101), and the following documents, as applicable to the site: the Mid-City Community Plan, the Greater North Park Community Plan, the State University Community Plan, the Uptown Community Plan, the Mid-City Design Plan (California State Polytechnic University, Pomona; Graduate studies in Landscape Architecture; June, 1983), Design Manual for the Normal Heights Demonstration Area and the City Heights Demonstration Area (HCH Associates and Gary Coad; April, 1984), The Design Study for the Commercial Revitalization of El Cajon Boulevard (Land Studio, Rob Quigley, Kathleen McCormick), The North Park Design Study, Volume 1, Design Concept and Volume 2, Design Manual (The Jerde Partnership, Inc. and Lawrence Reed Moline, Ltd.), Sears Site Development Program (Gerald Gast and Williams-Kuebelbeck and Assoc.; 1987) and will not adversely affect the Greater North Park Community Plan, the Uptown Community Plan or the General Plan of the City of San Diego; The proposed modifications have been designed to conceal all antennas inside FRP boxes painted and textured to match the existing building. The general concept is similar to the previously approved design with exception to the location of the FRP screenings. More importantly, each sector will continue to be completely concealed behind FRP panels, painted and textured to match the existing condominium. The 275-square foot equipment enclosure shall remain on the north elevation without any exterior changes. Therefore, as designed, the proposed modification will not adversely affect the Uptown Community Plan or the General Plan of the City of San Diego.

**5. Compatibility with surrounding development.** The proposed development will be compatible with existing and planned land use on adjoining properties and will not constitute a disruptive element to the neighborhood and community. In addition, architectural harmony with the surrounding neighborhood and community will be achieved as far as practicable; The proposed modification has been altered to improve the coverage objective to AT&T's overall network to the surrounding area. More importantly, the antennas will continue to be fully concealed on all four sectors. The FRP panels are reflected in the photosimulation is actually more coherently designed with the existing condominium. No longer are the FRP boxes located toward the center of the structure, instead, these antennas have been relocated to the upper portion of the building to appear as features to the condominium. An additional sector has been added to the rooftop behind a cupola to improve the overall coverage to the Balboa Park area. The proposed modifications would not constitute a disruptive element to the neighborhood and community since the antenna and equipment are completely concealed. In addition, the architectural harmony with the surrounding neighborhood and community would be preserved with the proposed modifications.

**6. No Detriment to Health, Safety and Welfare.** The proposed use, because of conditions that have been applied to it, will not be detrimental to the health, safety and general welfare of persons residing or working in the area, and will not adversely affect other property in the vicinity; The Telecommunication Act of 1996 preempts local governments from regulating the "placement, construction and modification of wireless communication facilities on the basis of the environmental effects of Radio Frequency (RF) emissions to the extent that such facilities comply with the Federal Communication Commission's (FCC) standards for such emissions."

The proposed project would be consistent with the FCC's regulations for wireless facilities. AT&T Mobility submitted an RF Report to staff demonstrating compliance with the required FCC regulations. Therefore, based on the above, the project would not result in any significant health or safety risks to the surrounding area within matters of City's jurisdiction.

**7. Adequate Public Facilities. For residential and mixed residential/commercial projects within the park-deficient neighborhoods shown on Map Number B-4104 that are not exempted by Section 1512.0203(b)(1)(A) or (B), the proposed development provides a minimum of 750 square feet of on-site usable recreational open space area per dwelling unit. The on-site usable recreational open space area shall not be located within any area of the site used for vehicle parking, or ingress and egress, and shall be configured to have a minimum of 10 feet in each dimension. The area will be landscaped and may also include hardscape and recreational facilities;** The proposed WCF is located on four sides of the building. All four sectors will be completely concealed inside FRP boxes, painted and textured to match the building. The associated equipment is located above the parking garage entrance and has minimal visibility. The proposed modification will not affect any existing open space area.

**8. Adequate Lighting. In the absence of a street light within 150 feet of the property, adequate neighborhood-serving security lighting consistent with the Municipal Code is provided on-site; and** The proposed Wireless Communication Facility would not result in any need for additional lighting to the property.

**9. The proposed use will comply with the relevant regulations in the San Diego Municipal Code.** The proposed WCF's modification for Sector D is located within the required MCCPD-MR-800B side yard setback and therefore requires a deviation to the setback requirements. AT&T is also requesting a deviation to maintain their equipment facility that exceeds the 250-square foot limit per Land Development Code (LDC) section 141.0420(g)(3). The project is also located on an existing condominium and as such, a Conditional Use Permit is required. As a result of these deviations, the project requires a Site Development Permit and a Conditional Use Permit, consolidated Process 4, Planning Commission decision, appealable to City Council. The Wireless Communication Regulations requires integration, and the project design complies with this section of the code by placing the antennas inside the stealth FRP boxes with the equipment facility minimally visible on the second story and above the parking garage. Besides the proposed deviations, the project will comply with the applicable regulations of the Land Development Code.

**10. The proposed structure height is appropriate because the location of the site, existing neighborhood character, and project design including massing, step backs, building façade composition and modulation, material and fenestration patterns when considered together, would ensure the development's compatibility with the existing character of the Uptown Community Plan Area.** The proposed AT&T WCF modification will not affect the overall existing structure height and therefore, would not adversely impact the character of the Uptown Community Plan Area.

**11. The proposed development includes an additional benefit to the community.** The proposed modifications to relocate the existing antennas and to add a new sector of antennas will significantly improve the coverage as well as alleviate the current network issues to visitors of Balboa Park. This will also eliminate the need to add a new facility in the surrounding area. While



the antennas are relocated to a higher elevation, each sector has been designed to integrate with the existing design of the condominium. As a result of these modifications, the FRP screening elements would appear as features to the structure as opposed to stand alone boxes on the side of the building. Every FRP feature is designed to keep the color and texture of the existing building as reflected in the photosimulations. The requested deviations to continue to operate within the required setbacks and above the equipment size limitation were approved by the Planning Commission on November 16, 1999. No changes are being proposed to these previously approved deviations.

BE IT FURTHER RESOLVED that, based on the findings hereinbefore adopted by the Planning Commission, Site Development Permit No. 825696 and Conditional Use Permit No. 825695 is hereby GRANTED by the Planning Commission to the referenced Owner/Permittee, in the form, exhibits, terms and conditions as set forth in Site Development Permit No. 825696 and Conditional Use Permit No. 825695 copy of which is attached hereto and made a part hereof.

---

Simon Tse - Associate Planner  
Development Services

Adopted on: March 29, 2012

Internal Order No. 24001305

**RECORDING REQUESTED BY**  
CITY OF SAN DIEGO  
DEVELOPMENT SERVICES  
PERMIT INTAKE, MAIL STATION 501

**WHEN RECORDED MAIL TO**

**PROJECT MANAGEMENT  
PERMIT CLERK  
MAIL STATION 501**

SPACE ABOVE THIS LINE FOR RECORDER'S USE

INTERNAL ORDER NUMBER: 24001305

**SITE DEVELOPMENT PERMIT NO. 825696  
CONDITIONAL USE PERMIT NO. 825695  
AT&T MOBILITY - SIXTH AVENUE LTE PROJECT NO. 225054  
PLANNING COMMISSION**

This Site Development Permit No. 825696 and Conditional Use Permit No. 825695 is granted by the Planning Commission of the City of San Diego to **BELLEFONTAINE CONDO OWNERS ASSOCIATION**, Owner, and **AT&T MOBILITY**, Permittee, pursuant to San Diego Municipal Code [SDMC] section Chapter 12, Article 6, Division 5 and Chapter 12, Article 6, Division 3, and LDC 141.0420 of the Wireless Communication Facilities regulations. The site is located at 2400 Sixth Avenue in the Mid Cities Community Planned District (MCCPD) -MR-800 zone of the Uptown Community Plan. The project site is legally described as Lots G, H, and I in block 282 of Horton's addition, in the City San Diego, State of California, according to the Map thereof filed July 21, 1871, in deed book 13, page 522, in the office of the County Recorder of San Diego County.

Subject to the terms and conditions set forth in this Permit, permission is granted to Owner and Permittee for a Wireless Communication Facility (WCF), described and identified by size, dimension, quantity, type, and location on the approved exhibits [Exhibit "A"] dated March 29, 2012, on file in the Development Services Department.

The project shall include:

- a. A modification to an existing Wireless Communication Facility (WCF) consisting of sixteen (16) panel antennas. The equipment associated with the project modification will continue to operate on the second story above the parking garage inside a 275-square foot enclosure equipment platform, not visible to the public; and
- b. Public and private accessory improvements determined by the Development Services Department to be consistent with the land use and development standards for this site in

accordance with the adopted community plan, the California Environmental Quality Act [CEQA] and the CEQA Guidelines, the City Engineer's requirements, zoning regulations, conditions of this Permit, and any other applicable regulations of the SDMC.

**STANDARD REQUIREMENTS:**

1. This permit must be utilized within thirty-six (36) months after the date on which all rights of appeal have expired. If this permit is not utilized in accordance with Chapter 12, Article 6, Division 1 of the SDMC within the 36 month period, this permit shall be void unless an Extension of Time has been granted. Any such Extension of Time must meet all SDMC requirements and applicable guidelines in effect at the time the extension is considered by the appropriate decision maker. This permit must be utilized by April 12, 2015.
2. This Site Development Permit [SDP] and Conditional Use Permit [CUP] and corresponding use of this site shall expire on **March 29, 2022**. Upon expiration of this Permit, the facilities and improvements described herein shall be removed from this site and the property shall be restored to its original condition preceding approval of this Permit.
3. No later than ninety (90) days prior to the expiration of this permit, the Owner/Permittee may submit a new application to the City Manager for consideration with review and a decision by the appropriate decision maker at that time. Failure to submit prior to the deadline will be cause for compliance, which may include penalties and fines.
4. Under no circumstances, does approval of this permit authorize AT&T Mobility or their tenants to utilize this site for wireless communication purposes beyond the permit expiration date. Implicit use of this permit beyond the effective date of this permit is prohibited.
5. No permit for the construction, occupancy, or operation of any facility or improvement described herein shall be granted, nor shall any activity authorized by this Permit be conducted on the premises until:
  - a. The Owner/Permittee signs and returns the Permit to the Development Services Department; and
  - b. The Permit is recorded in the Office of the San Diego County Recorder.
6. While this Permit is in effect, the subject property shall be used only for the purposes and under the terms and conditions set forth in this Permit unless otherwise authorized by the appropriate City decision maker.
7. This Permit is a covenant running with the subject property and all of the requirements and conditions of this Permit and related documents shall be binding upon the Owner/Permittee and any successor(s) in interest.



8. The continued use of this Permit shall be subject to the regulations of this and any other applicable governmental agency.

9. Issuance of this Permit by the City of San Diego does not authorize the Owner/Permittee for this Permit to violate any Federal, State or City laws, ordinances, regulations or policies including, but not limited to, the Endangered Species Act of 1973 [ESA] and any amendments thereto (16 U.S.C. § 1531 et seq.).

10. The Owner/Permittee shall secure all necessary building permits. The Owner/Permittee is informed that to secure these permits, substantial building modifications and site improvements may be required to comply with applicable building, fire, mechanical, and plumbing codes, and State and Federal disability access laws.

11. Construction plans shall be in substantial conformity to Exhibit "A." Changes, modifications, or alterations to the construction plans are prohibited unless appropriate application(s) or amendment(s) to this Permit have been granted.

12. All of the conditions contained in this Permit have been considered and were determined-necessary to make the findings required for approval of this Permit. The Permit holder is required to comply with each and every condition in order to maintain the entitlements that are granted by this Permit.

If any condition of this Permit, on a legal challenge by the Owner/Permittee of this Permit, is found or held by a court of competent jurisdiction to be invalid, unenforceable, or unreasonable, this Permit shall be void. However, in such an event, the Owner/Permittee shall have the right, by paying applicable processing fees, to bring a request for a new permit without the "invalid" condition(s) back to the discretionary body which approved the Permit for a determination by that body as to whether all of the findings necessary for the issuance of the proposed permit can still be made in the absence of the "invalid" condition(s). Such hearing shall be a hearing de novo, and the discretionary body shall have the absolute right to approve, disapprove, or modify the proposed permit and the condition(s) contained therein.

13. The Owner/Permittee shall defend, indemnify, and hold harmless the City, its agents, officers, and employees from any and all claims, actions, proceedings, damages, judgments, or costs, including attorney's fees, against the City or its agents, officers, or employees, relating to the issuance of this permit including, but not limited to, any action to attack, set aside, void, challenge, or annul this development approval and any environmental document or decision. The City will promptly notify Owner/Permittee of any claim, action, or proceeding and, if the City should fail to cooperate fully in the defense, the Owner/Permittee shall not thereafter be responsible to defend, indemnify, and hold harmless the City or its agents, officers, and employees. The City may elect to conduct its own defense, participate in its own defense, or obtain independent legal counsel in defense of any claim related to this indemnification. In the event of such election, Owner/Permittee shall pay all of the costs related thereto, including without limitation reasonable attorney's fees and costs. In the event of a disagreement between the City and Owner/Permittee regarding litigation issues, the City shall have the authority to control the litigation and make litigation related decisions, including, but not limited to,

settlement or other disposition of the matter. However, the Owner/Permittee shall not be required to pay or perform any settlement unless such settlement is approved by Owner/Permittee.

**ENGINEERING REQUIREMENTS:**

14. Prior to the issuance of any construction permits, the Owner/Permittee shall incorporate any construction Best Management Practices necessary to comply with Chapter 14, Article 2, Division 1 (Grading Regulations) of the Municipal Code, into the construction plans or specifications.

15. Prior to the issuance of any construction permits, the Owner/Permittee shall submit a Water Pollution Control Plan (WPCP). The WPCP shall be prepared in accordance with the guidelines in Appendix E of the City's Storm Water Standards.

**PLANNING/DESIGN REQUIREMENTS:**

16. Owner/Permittee shall not cause or allow the antennas located on the WCF to be different sizes (length, width, or height) than as shown on the stamped approved plans and as listed here:

17. Sixteen (16) antennas with the following dimensions: 96" by 11.8" by 6".

18. Prior to issuance of construction permits for this project, the Owner/Permittee shall remove all Metricom antennas and associated equipment and restore the buildings to its original condition to the satisfactory of Development Services Department.

19. The Permittee shall be responsible for removing the existing Fiberglass Reinforced Panel (FRP) screen boxes on the north, south and west elevations. These building facade shall be restored back to its original condition to the satisfactory of Development Services Department.

20. No more than four (4) antennas shall be concealed inside a new FRP screen box (16' by 12' by 18") located on the south elevation, painted and textured to match the existing building to the satisfactory of Development Services Department.

21. No more than eight (8) antennas shall be concealed inside a new four-sided FRP screening located on the northwest elevation, painted to match the existing building to the satisfactory of Development Services Department.

22. No more than four (4) antennas shall be concealed in a new rooftop cupola (8'-6" by 16' by 7') painted and textured to match the existing building to the satisfactory of Development Services Department.

23. The existing cable tray shall be extended as illustrated on the stamped approved 'Exhibit A' and shall be painted and textured to match to the satisfactory of Development Services Department.

24. Use of or replacement of any building façade or mechanical screen with FRP material for purposes of concealing antennas shall not result in any noticeable lines or edges in the transition to the original building. All FRP shall be painted and textured to match the original building.
25. The Owner/Permittee shall be required to place appropriate signs per CAL-OSHA requirements to the satisfaction of Development Services Department.
26. Final inspection shall not be granted until the final product conforms to the stamp approved plans and approved photosimulations.
27. The photosimulation(s) for the proposed project must be printed (not stapled) on the building plans. This is to ensure the construction team building the project is aware of what the completed design was approved to look like. Final inspection shall not be granted until the final product conforms to the stamp approved plans and approved photosimulation(s).
28. As a result of this approval, Conditional Use Permit No. 782390 and Site Development Permit No. 787611 shall be null and void.

**INFORMATION ONLY:**

- The issuance of this discretionary use permit alone does not allow the immediate commencement or continued operation of the proposed use on site. The operation allowed by this discretionary use permit may only begin or recommence after all conditions listed on this permit are fully completed and all required ministerial permits have been issued and received final inspection.
- Any party on whom fees, dedications, reservations, or other exactions have been imposed as conditions of approval of this Permit, may protest the imposition within ninety days of the approval of this development permit by filing a written protest with the City Clerk pursuant to California Government Code-section 66020.
- This development may be subject to impact fees at the time of construction permit issuance.
- Please note that an Administrative Planning Hold will be placed on the project prior to Final Clearance from the City's Building Inspector to ensure compliance with the approved plans and associated conditions. Prior to calling for your Final Inspection from your building inspection official, please contact the Project Manager listed below at (619) 687-5984 to schedule an inspection of the completed facility. Please schedule this administrative inspection at least five working days ahead of the requested Final Inspection date.

APPROVED by the Planning Commission of the City of San Diego on **March 29, 2012** by Resolution Number \_\_\_\_\_.



Site Development Permit No. 825696  
Conditional Use Permit No. 825695  
Date of Approval: March 29, 2012

AUTHENTICATED BY THE CITY OF SAN DIEGO DEVELOPMENT SERVICES DEPARTMENT

\_\_\_\_\_  
Simon Tse  
Associate Planner

**NOTE: Notary acknowledgment  
must be attached per Civil Code  
section 1189 et seq.**

\_\_\_\_\_  
**The undersigned Owner/Permittee, by execution hereof, agrees to each and every condition of  
this Permit and promises to perform each and every obligation of Owner/Permittee hereunder.**

BELLEFONTAINE CONDO OWNERS ASSOCIATION  
Owner

By \_\_\_\_\_  
NAME  
TITLE

AT&T MOBILITY  
Permittee

By \_\_\_\_\_  
NAME  
TITLE

**NOTE: Notary acknowledgments  
must be attached per Civil Code  
section 1189 et seq.**

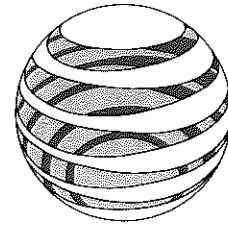

at&t

# SD0013 LTE OPTIMAL 2400 SIXTH AVENUE LTE OPTIMAL

2400 SIXTH AVENUE  
SAN DIEGO, CA 92101

ARCHITECT



DI DONATO ASSOCIATES  
ARCHITECTURE + GRAPHICS  
9399 FIRST AVENUE, SUITE 100, SAN DIEGO, CA 92103  
619.299.4210 • 619.299.4250 FAX • DDAMAIL@AOL.COM

PROJECT NAME



SD0013 LTE OPTIMAL  
2400 SIXTH AVENUE LTE OPTIMAL  
2400 SIXTH AVENUE SAN DIEGO, CA 92101

ISSUES REVISIONS

DATE	BY	ISSUE DESCRIPTION	REVISIONS
05-19-11	CHK	REVISED PER GPS LOCATION	Z05

SHEET INFORMATION

DI DONATO ASSOCIATES  
ARCHITECTURE + GRAPHICS

**T01**  
TITLE SHEET

SD0013 LTE OPTIMAL

1029.27  
PLOT SCALE 1:1 (11x17 PAPER SIZE)

**DRIVING DIRECTIONS FROM AT&T OFFICE:**

- HEAD SOUTHWEST ON PACIFIC CENTER BOULEVARD
- TURN LEFT AT LUSK BOULEVARD
- TURN RIGHT AT MIRA MESA BOULEVARD
- CONTINUE ONTO SORRENTO VALLEY ROAD
- TAKE I-805 SOUTH
- TAKE CA-163 SOUTH
- EXIT AT UNIVERSITY AVENUE
- MERGE ONTO SIXTH AVENUE
- SITE WILL BE ON THE RIGHT

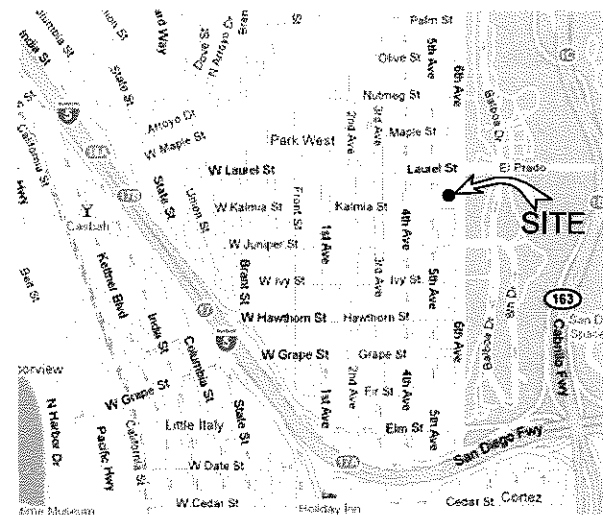

THOMAS GUIDE MAP #1289-A1

**VICINITY MAP**

1

LOTS G, H AND I IN BLOCK 282 OF HORTON'S ADDITION, IN THE CITY OF SAN DIEGO, STATE OF CALIFORNIA, ACCORDING TO THE MAP THEREOF FILED JULY 21, 1871, IN DEED BOOK 13, PAGE 522, IN THE OFFICE OF THE RECORDER OF SAID SAN DIEGO COUNTY.

**LEGAL DESCRIPTION**

5

**PROJECT APPLICANT:**  
AT&T MOBILITY  
5738 PACIFIC CENTER BLVD.  
SAN DIEGO, CA 92121

**CONSTRUCTION MANAGER:**  
CRAIG MCNULTY  
BLACK & VEATCH  
9920 WILLOW CREEK RD. STE. 310  
SAN DIEGO, CA 92131  
619.200.8664 PHONE

**PLANNING REPRESENTATIVE:**  
JIM KENNEDY  
TAIC  
9089 CLAIREMONT MESA BLVD. STE. 200  
SAN DIEGO, CA 92123  
619.593.1057 PHONE

**SITE ACQUISITION:**  
NICK FOSTER  
TAIC  
9089 CLAIREMONT MESA BLVD. STE. 200  
SAN DIEGO, CA 92123

**R.F. ENGINEERING REPRESENTATIVE:**  
RAVI JINDAL  
AT&T MOBILITY  
5738 PACIFIC CENTER BLVD.  
SAN DIEGO, CA 92121  
619.699.9254 PHONE

**PROPERTY OWNER:**  
BELLEFONTAINE CONDO OWNERSHIP ASSOCIATION  
3737 FIFTH AVE. STE. 204  
SAN DIEGO, CA 92101  
619.295.8711 PHONE

**ARCHITECT:**  
DI DONATO ASSOCIATES  
3939 FIRST AVE. STE. 100  
SAN DIEGO, CA 92103  
619.299.4210 PHONE  
619.299.4250 FAX  
dd@mail@aol.com

**PROJECT DESCRIPTION:**

THE PROJECT CONSISTS OF THE MODIFICATION OF AN EXISTING AT&T TELECOMMUNICATIONS SITE CONSISTING OF THE FOLLOWING:

A TOTAL OF (10) TEN PREVIOUSLY APPROVED ANTENNAS ARE TO BE REPLACED AND RELOCATED AND (6) SIX PROPOSED ANTENNAS ARE TO BE ADDED TO AN EXISTING RESIDENTIAL CONDOMINIUM BUILDING. ALL (16) SIXTEEN ANTENNAS ARE TO BE LOCATED BEHIND A PROPOSED CONCEALMENT CUPOLA AND CONCEALMENT SCREENS. OUTDOOR EQUIPMENT CABINETS ARE TO BE ADDED WITHIN AN EXISTING EQUIPMENT ENCLOSURE LOCATED ON AN EXISTING RAISED PLATFORM AT THE SECOND FLOOR OF THE BUILDING. ADDITIONALLY, (12) TWELVE TMA'S ARE TO BE RELOCATED AND (1) ONE GPS ANTENNA, (4) FOUR TMA'S, (16) SIXTEEN RRUS'S AND (4) FOUR SURGE SUPPRESSORS ARE TO BE ADDED.

THE FACILITY WILL ENHANCE THE GENERAL HEALTH, SAFETY, AND WELFARE OF THE COUNTY AND SURROUNDING CITIES BY PROVIDING MORE RELIABLE CELLULAR COMMUNICATION FROM THIS LOCATION.

NOTE: EXISTING CARRIERS: AT&T, CRICKET

**SITE ADDRESS:**  
2400 SIXTH AVE.  
SAN DIEGO, CA 92101

**JURISDICTION:**  
CITY OF SAN DIEGO

**ASSESSORS' PARCEL NUMBER:**  
533-104-05-01 THRU 533-104-05-30

**CURRENT USE:**  
CONDOMINIUM

**LATITUDE:**  
32°43'50.41"N

**EXISTING OCCUPANCY:**  
R-1, U, S-2 (AT EQUIPMENT ROOM)

**LONGITUDE:**  
117°09'34.65"W

**PROPOSED OCCUPANCY:**  
UNCHANGED

**TOTAL SITE AREA:**  
11,665 SF

**SETBACKS:**  
FRONT: 10'  
SIDE: 6' MIN., 15' MAX.  
STREET SIDE: 6'  
REAR: 15'

**EXISTING FLOOR AREA:**  
N/A

**WATER/SEWAGE:**  
N/A

**PROPOSED PROJECT AREA:**  
N/A

**UTILITIES:**

**EXISTING TYPE OF CONSTRUCTION:**  
TYPE V-B

ELECTRICAL: SDG&E

**PROPOSED TYPE OF CONSTRUCTION:**  
TYPE V-B

TELEPHONE: AT&T

**EXISTING ZONING:**  
MCCPD-MR-8008

FIRE DEPT.: CITY OF SAN DIEGO

ALL WORK SHALL COMPLY WITH THE FOLLOW APPLICABLE CODES:

- CALIFORNIA BUILDING CODE, 2010 EDITION
- CALIFORNIA PLUMBING CODE, 2010 EDITION
- CALIFORNIA MECHANICAL CODE, 2010 EDITION
- CALIFORNIA ELECTRICAL CODE, 2010 EDITION
- CALIFORNIA FIRE CODE, 2010 EDITION

IN THE EVENT OF CONFLICT, THE MOST RESTRICTIVE CODE SHALL PREVAIL

**PROJECT INFORMATION**

3

FACILITY IS UNMANNED AND NOT FOR HUMAN HABITATION. WIRELESS TELECOMMUNICATIONS MECHANICAL EQUIPMENT ROOMS ARE EXEMPT FROM REQUIREMENTS TO PROVIDE BUILDING UPGRADES FOR DISABLED ACCESS PER THE FOLLOWING:

IBC SECTION 1105B-BUILDING ACCESSIBILITY  
CAL ACS ACCESSIBILITY STANDARDS INTERPRETIVE MANUAL

**ADA COMPLIANCE**

7

**CONTACTS**

2

TECHNOLOGY	ERP (WATTS)	TRANSMIT (MHz)		RECEIVE (MHz)	
		START	STOP	START	STOP
LTE	500.0	704.0	716.0	734.0	746.0

**LTE FREQUENCY CHART**

6

**SHEET INDEX**

4

CONSTRUCTION REPRESENTATIVE	
SITE ACQUISITION	
R.F. ENGINEERING REPRESENTATIVE	
PLANNING REPRESENTATIVE	
AT&T REPRESENTATIVE	
LANDLORD	
A/E COORDINATOR	

**APPROVALS**

8



DI DONATO ASSOCIATES  
ARCHITECTURE + GRAPHICS  
6500 FIRST AVENUE, SUITE 100, SAN DIEGO, CA 92103  
619.299.2210 • 619.299.4200 FAX • DDONATO@A+G.COM

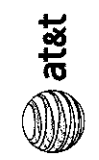

SD0013 LTE OPTIMAL  
2400 SIXTH AVENUE LTE OPTIMAL  
2400 SIXTH AVENUE SAN DIEGO, CA 92101

DATE	BY	ISSUE DESCRIPTION	REVISED PER GPS LOCATION
05-16-11	CKK		Z04

DI DONATO ASSOCIATES  
ARCHITECTURE + GRAPHICS

**Z01**  
SITE PLAN

THESE DRAWINGS, DRAWINGS AND SPECIFICATIONS ARE THE PROPERTY AND COPYRIGHT OF DD&G AND SHALL NOT BE USED IN CONNECTION WITH ANY OTHER WORK EXCEPT BY AGREEMENT WITH DD&G. THERE SHALL BE NO CHANGES OR DEVIATION WITHOUT THE CONSENT OF DD&G. WRITTEN DIMENSIONS SHALL BE BROUGHT TO THE NOTICE OF THE DDA PRIOR TO THE COMMENCEMENT OF ANY WORK.

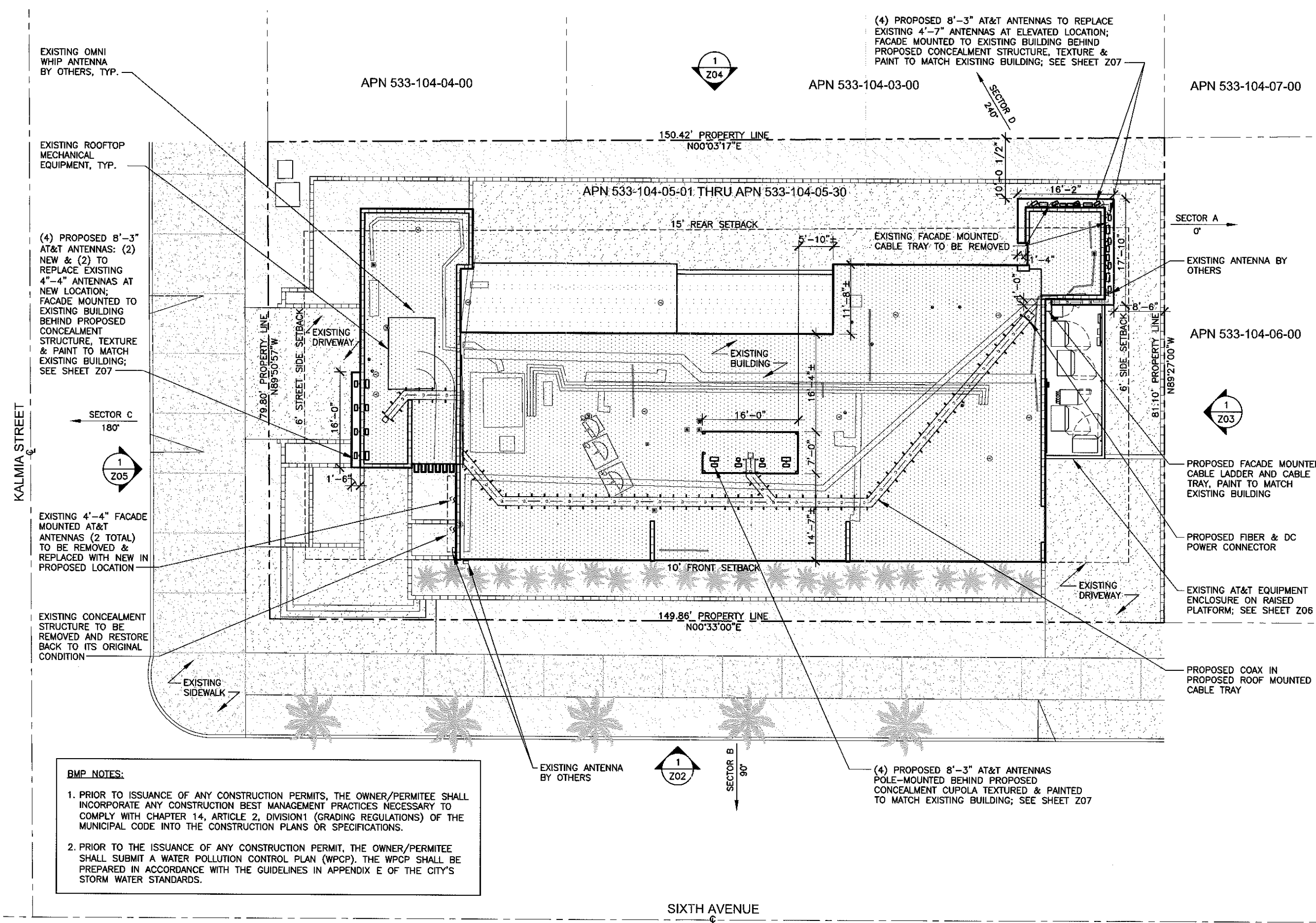

EXISTING OMNI WHIP ANTENNA BY OTHERS, TYP.

EXISTING ROOFTOP MECHANICAL EQUIPMENT, TYP.

(4) PROPOSED 8'-3" AT&T ANTENNAS: (2) NEW & (2) TO REPLACE EXISTING 4"-4" ANTENNAS AT NEW LOCATION; FACADE MOUNTED TO EXISTING BUILDING BEHIND PROPOSED CONCEALMENT STRUCTURE, TEXTURE & PAINT TO MATCH EXISTING BUILDING; SEE SHEET Z07

EXISTING 4"-4" FACADE MOUNTED AT&T ANTENNAS (2 TOTAL) TO BE REMOVED & REPLACED WITH NEW IN PROPOSED LOCATION

EXISTING CONCEALMENT STRUCTURE TO BE REMOVED AND RESTORE BACK TO ITS ORIGINAL CONDITION

**BMP NOTES:**

1. PRIOR TO ISSUANCE OF ANY CONSTRUCTION PERMITS, THE OWNER/PERMITEE SHALL INCORPORATE ANY CONSTRUCTION BEST MANAGEMENT PRACTICES NECESSARY TO COMPLY WITH CHAPTER 14, ARTICLE 2, DIVISION 1 (GRADING REGULATIONS) OF THE MUNICIPAL CODE INTO THE CONSTRUCTION PLANS OR SPECIFICATIONS.
2. PRIOR TO THE ISSUANCE OF ANY CONSTRUCTION PERMIT, THE OWNER/PERMITEE SHALL SUBMIT A WATER POLLUTION CONTROL PLAN (WPCP). THE WPCP SHALL BE PREPARED IN ACCORDANCE WITH THE GUIDELINES IN APPENDIX E OF THE CITY'S STORM WATER STANDARDS.

(4) PROPOSED 8'-3" AT&T ANTENNAS TO REPLACE EXISTING 4'-7" ANTENNAS AT ELEVATED LOCATION; FACADE MOUNTED TO EXISTING BUILDING BEHIND PROPOSED CONCEALMENT STRUCTURE, TEXTURE & PAINT TO MATCH EXISTING BUILDING; SEE SHEET Z07

(4) PROPOSED 8'-3" AT&T ANTENNAS POLE-MOUNTED BEHIND PROPOSED CONCEALMENT CUPOLA TEXTURED & PAINTED TO MATCH EXISTING BUILDING; SEE SHEET Z07

SITE PLAN  
1/16"=1'-0"

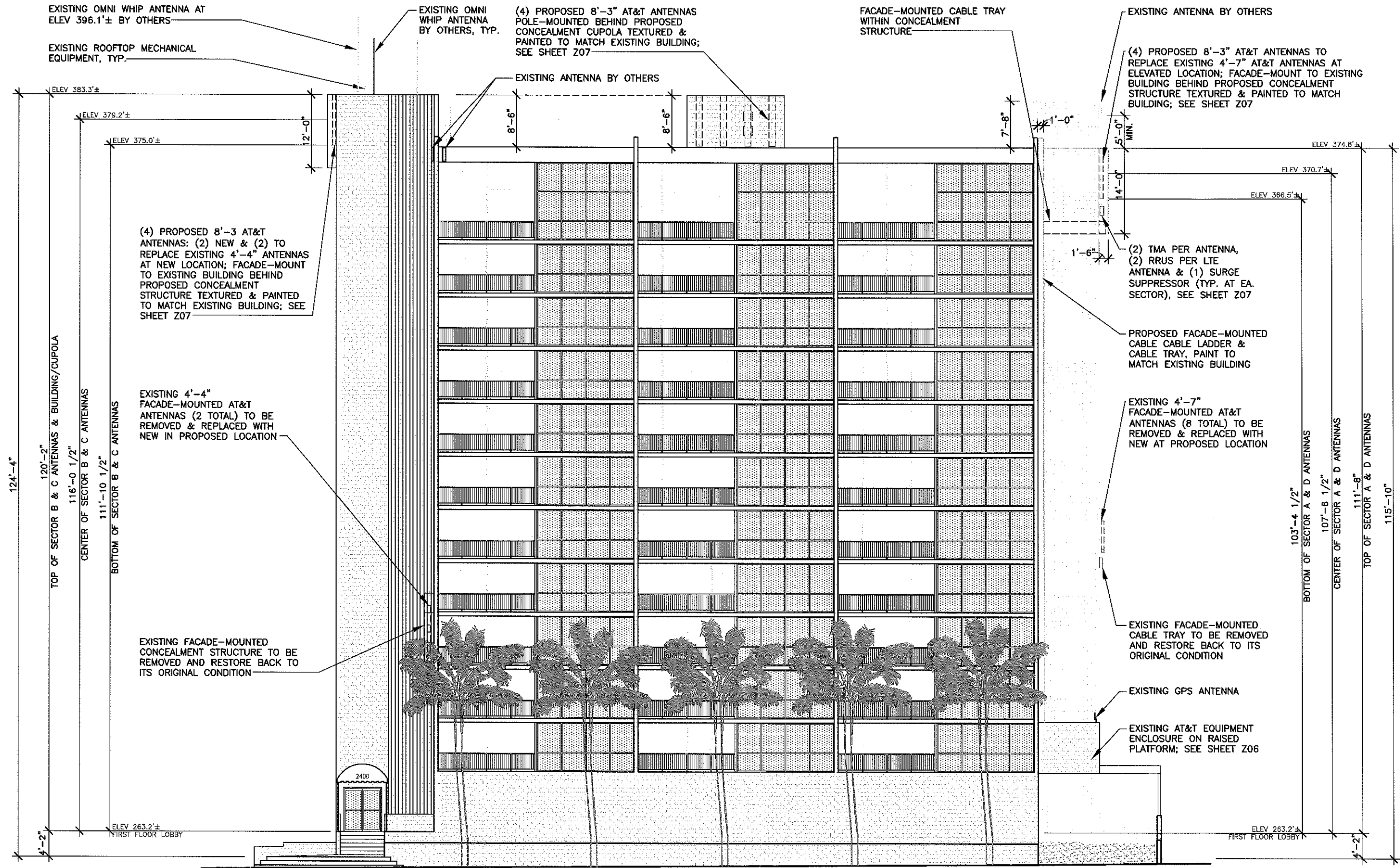

EAST ELEVATION  
1/16"=1'-0"

ARCHITECT



**DI DONATO ASSOCIATES**  
ARCHITECTURE + GRAPHICS  
8500 FIRST AVENUE, SUITE 100, SAN DIEGO, CA 92103  
619.295.4610 • 619.295.4628 FAX • DDONATO@AAGL.COM

---

PROJECT NAME



**SD0013 LTE OPTIMAL**  
**2400 SIXTH AVENUE LTE OPTIMAL**  
2400 SIXTH AVENUE SAN DIEGO, CA 92101

---

ISSUES REVISIONS

DATE	BY	ISSUE DESCRIPTION	ZONING
05-15-11	CHK	REVISED PER GPS LOCATION	Z0a

---

SHEET INFORMATION

**DI DONATO ASSOCIATES**  
ARCHITECTURE + GRAPHICS

# Z02

EAST ELEVATION

1020.27  
PLOT SCALE 1:1 (11x17 PAPER SIZE)

THESE DRAWING, DRAWINGS AND SPECIFICATIONS ARE THE PROPERTY AND COPYRIGHT OF DONATO ASSOCIATES. ANY REUSE OR REPRODUCTION OF ANY PART OF THIS DOCUMENT WITHOUT THE WRITTEN CONSENT OF DONATO ASSOCIATES IS STRICTLY PROHIBITED. ANY DISCREPANCY SHALL BE BROUGHT TO THE NOTICE OF THE USER PRIOR TO THE COMMENCEMENT OF ANY WORK.



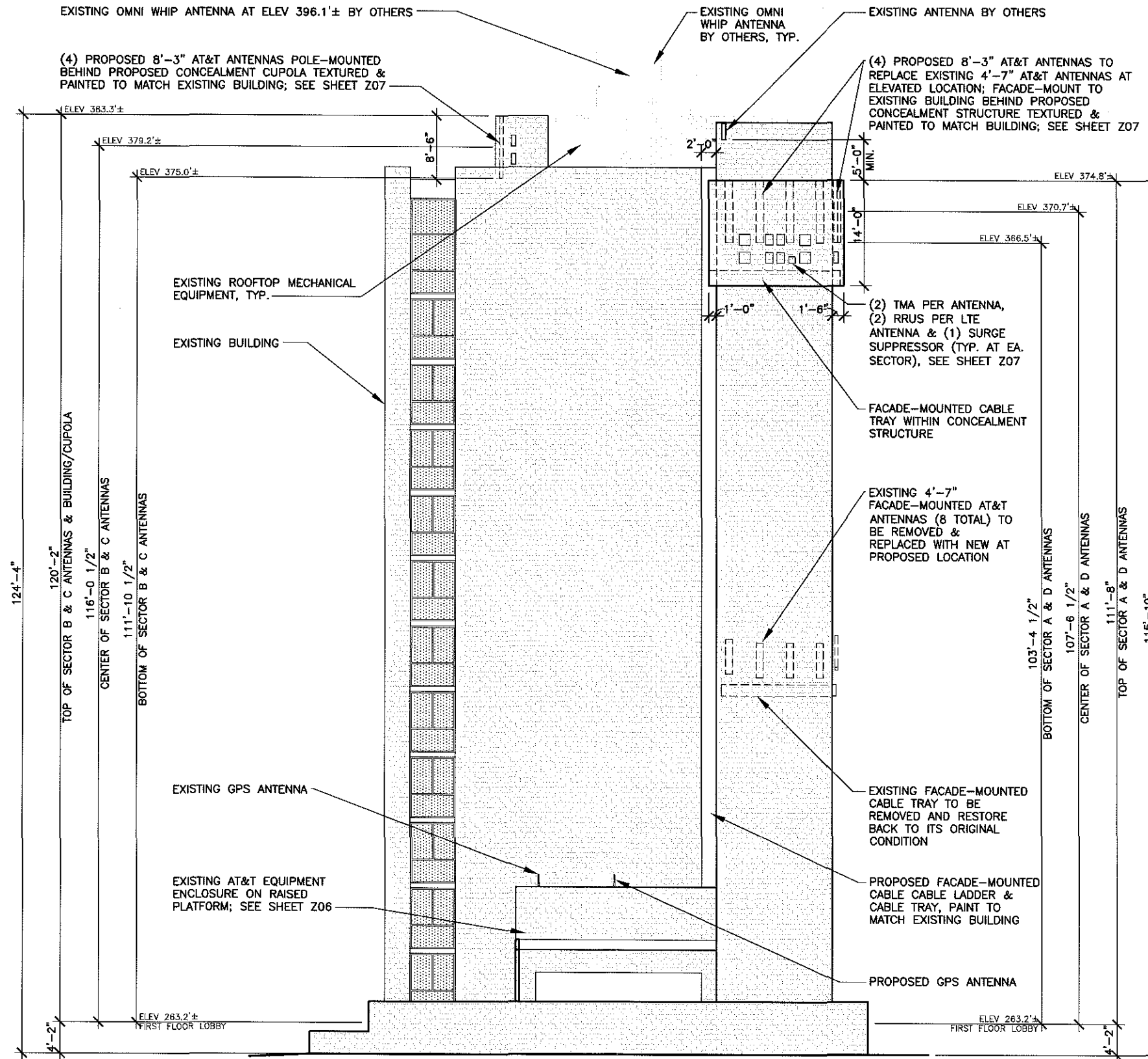

NORTH ELEVATION  
1/16"=1'-0"

THESE DESIGN DRAWINGS AND SPECIFICATIONS ARE THE PROPERTY AND COPYRIGHT OF DD&A AND SHALL NOT BE USED IN CONNECTION WITH ANY OTHER WORK EXCEPT BY AGREEMENT WITH DD&A. THERE SHALL BE NO CHANGES OR DEVIATION WITHOUT THE CONSENT OF DD&A. WRITTEN DIMENSIONS SHALL BE USED IN THE EVENT OF A DISCREPANCY. ANY DISCREPANCY SHALL BE RESOLVED TO THE NOTICE OF THE OWNER PRIOR TO THE COMMENCEMENT OF ANY WORK.

ARCHITECT



**DD&A**  
DI DONATO ASSOCIATES  
ARCHITECTURE + GRAPHICS  
3909 FIRST AVENUE - SUITE 100 - SAN DIEGO, CA 92103  
619.299.4210 - 619.299.4250 FAX - DD&A@AOL.COM

PROJECT NAME



**SD0013 LTE OPTIMAL  
2400 SIXTH AVENUE LTE OPTIMAL  
2400 SIXTH AVENUE SAN DIEGO, CA 92101**

ISSUES REVISIONS	
DATE	BY
05-18-11	CWK
	REVISED PER GPS LOCATION
	Z03

SHEET INFORMATION



**Z03**  
NORTH ELEVATION

1029.37  
PLOT SCALE 1:1 (11x17 PAPER SIZE)

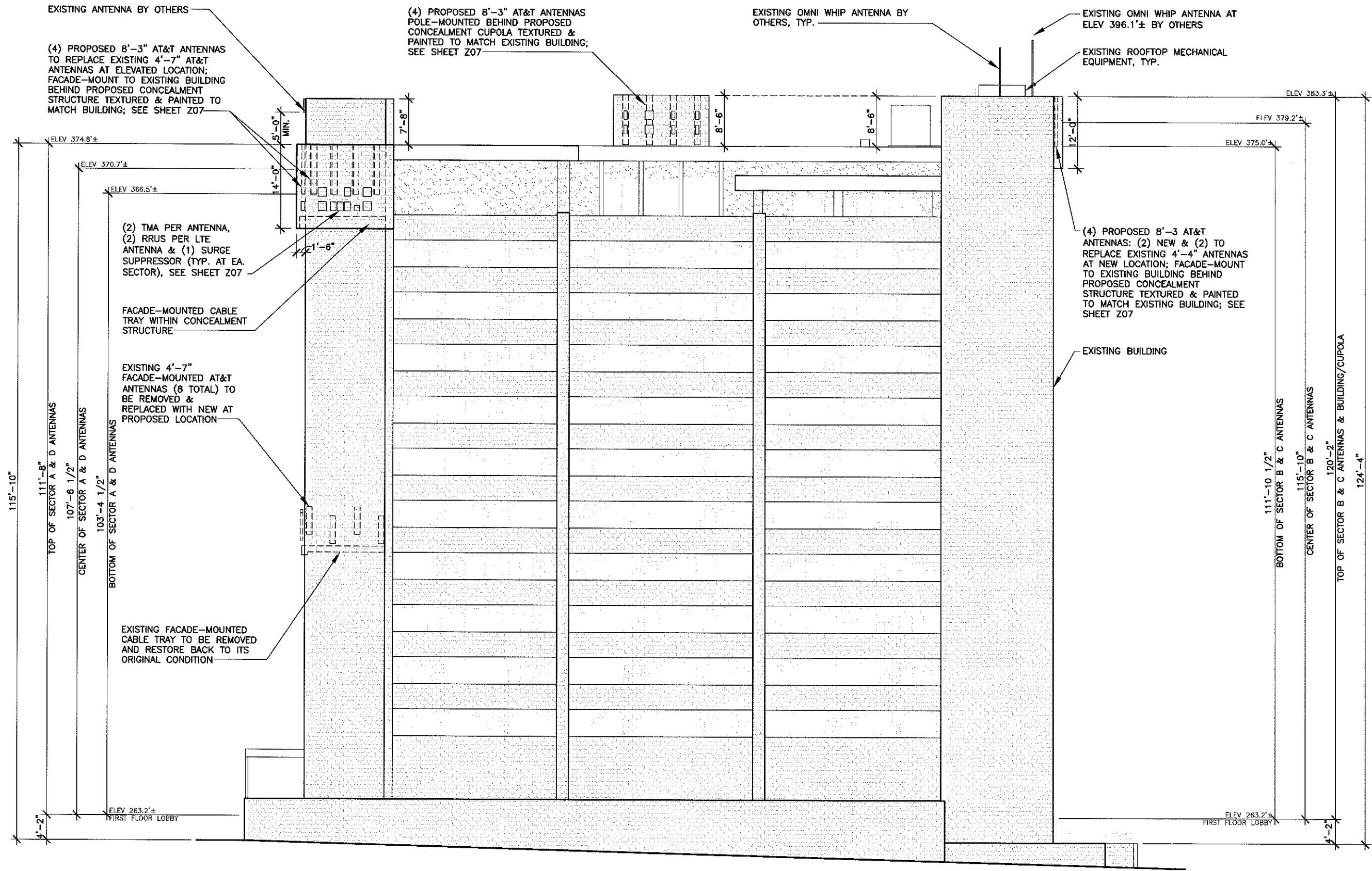

WEST ELEVATION  
1/16" = 1'-0"

ARCHITECT



SD0013 LTE OPTIMAL  
2400 SIXTH AVENUE LTE OPTIMAL  
2400 SIXTH AVENUE SAN DIEGO, CA 92101



DI DONATO ASSOCIATES  
ARCHITECTURE + GRAPHICS  
8559 FIRST AVENUE, SUITE 100, SAN DIEGO, CA 92103  
619.594.6170 • 619.291.4200 FAX • DDANAL@GMAIL.COM

PROJECT NAME

SD0013 LTE OPTIMAL  
2400 SIXTH AVENUE LTE OPTIMAL  
2400 SIXTH AVENUE SAN DIEGO, CA 92101

ISSUES REVISIONS	
DATE	DESCRIPTION
05-16-11	CHK REVISED PER GPS LOCATION
	Z04

SHEET INFORMATION

DI DONATO ASSOCIATES  
ARCHITECTURE + GRAPHICS

# Z04

WEST ELEVATION

1028.27  
PLOT SCALE 1 : 1 (11x17 PAPER SIZE)

THESE DESIGN DRAWINGS AND SPECIFICATIONS ARE THE PROPERTY AND COPYRIGHT OF DDA AND SHALL NOT BE USED IN CONNECTION WITH ANY OTHER WORK EXCEPT BY AGREEMENT WITH DDA. THERE SHALL BE NO CHANGES OR DEVIATIONS WITHOUT THE CONSENT OF DDA. WRITTEN DIMENSIONS SHALL BE VERIFIED ON THE JOB SITE. ANY DISCREPANCY SHALL BE BROUGHT TO THE NOTICE OF THE ODA PRIOR TO THE COMMENCEMENT OF ANY WORK.

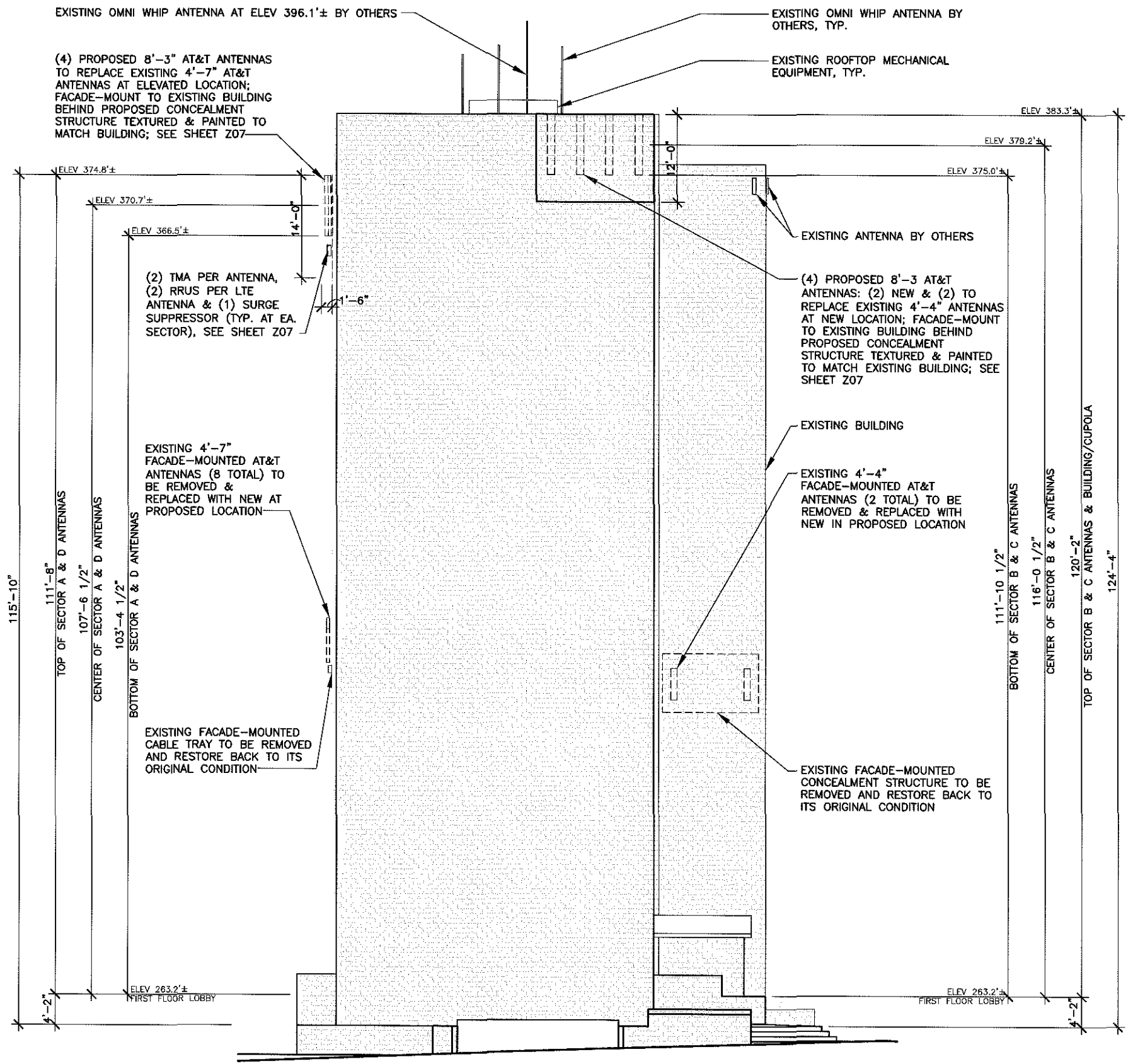

**SOUTH ELEVATION**  
1/16"=1'-0"

ARCHITECT



**DI DONATO ASSOCIATES**  
ARCHITECTURE + GRAPHICS  
8550 FIRST AVENUE, SUITE 100, SAN DIEGO, CA 92103  
619.295.8211 • 619.295.4280 FAX: DDDAMA@AACL.COM

---

PROJECT NAME



**SD0013 LTE OPTIMAL**  
**2400 SIXTH AVENUE LTE OPTIMAL**  
2400 SIXTH AVENUE SAN DIEGO, CA 92101

---

ISSUES REVISIONS

DATE	BY	ISSUE	DESCRIPTION	Z05
05-16-11	CHK	REVISED	PBT GPS LOCATION	

---

SHEET INFORMATION

**DI DONATO ASSOCIATES**  
ARCHITECTURE + GRAPHICS

# Z05

**SOUTH ELEVATION**

1029.27  
PLOT SCALE 1 : 1 (11x17 PAPER SIZE)

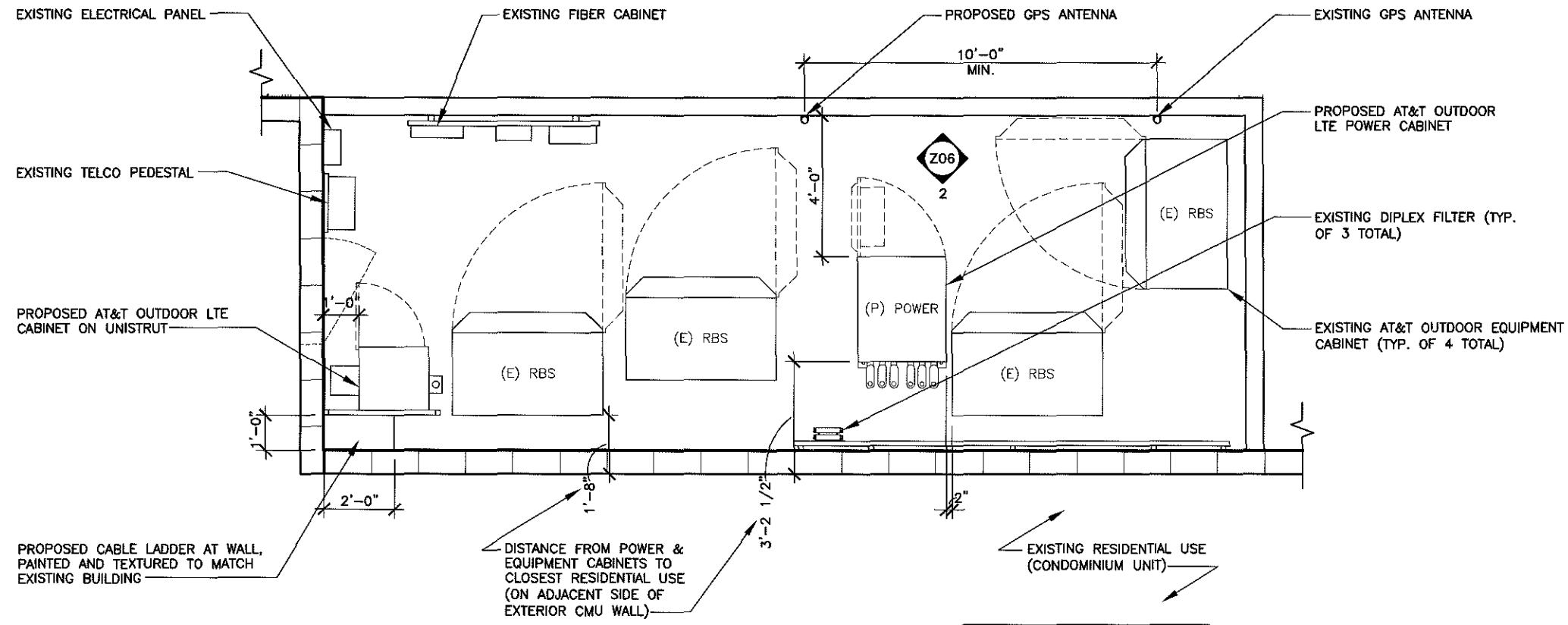

**EQUIPMENT PLAN**  
1/4"=1'-0"

**OUTDOOR EQUIPMENT** 1

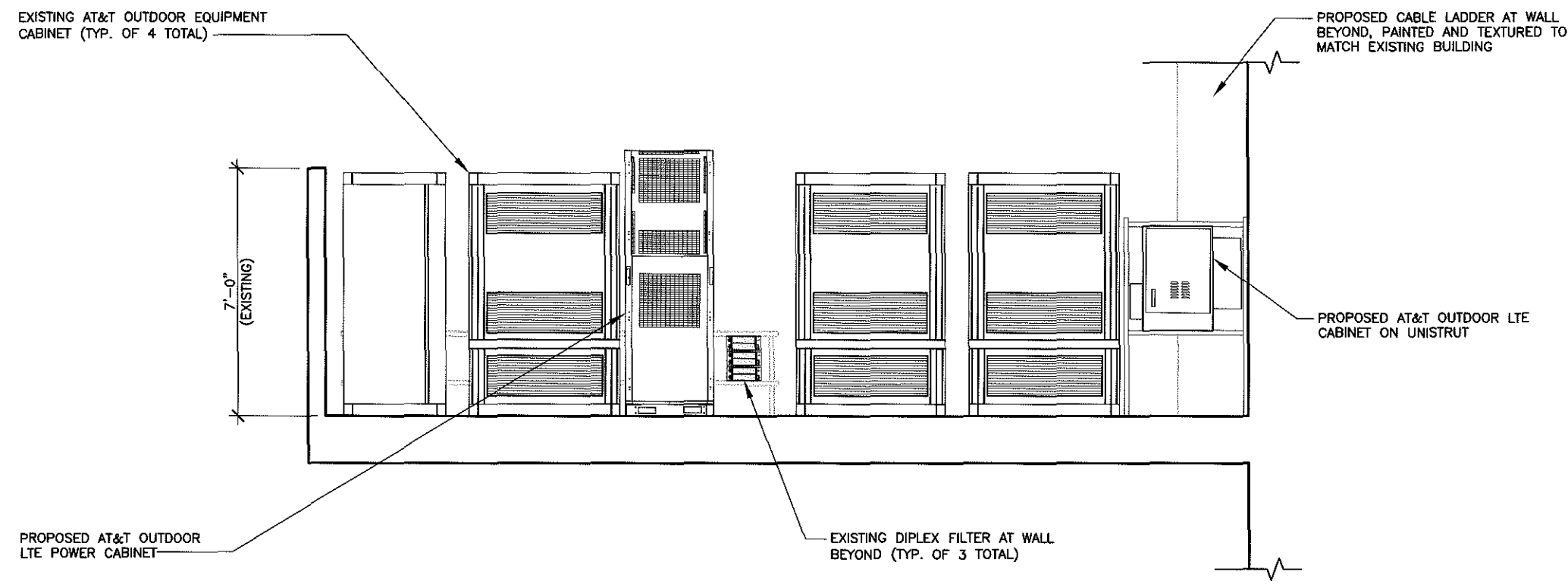

**EQUIPMENT ELEVATION**  
1/4"=1'-0"

2

ARCHITECT



**DE DONATO ASSOCIATES**  
ARCHITECTURE + GRAPHICS  
3939 FIRST AVENUE, SUITE 100, SAN DIEGO, CA 92103  
619.298.4210 • 619.298.4250 FAX • DDANAM@AOL.COM

PROJECT NAME

**SD0013 LTE OPTIMAL**  
**2400 SIXTH AVENUE LTE OPTIMAL**  
2400 SIXTH AVENUE SAN DIEGO, CA 92101

DATE	BY	ISSUE DESCRIPTION	CHK.	REVISED PER	GPS LOCATION
09-16-11	CK				

SHEET INFORMATION

**DE DONATO ASSOCIATES**  
ARCHITECTURE + GRAPHICS

Z06

EQUIPMENT PLAN,  
ELEVATION

1029.27  
PLOT SCALE 1:1 (11x17 PAPER SIZE)

THESE DESIGN DRAWINGS AND SPECIFICATIONS ARE THE PROPERTY AND COPYRIGHT OF DDA AND SHALL NOT BE USED IN CONNECTION WITH ANY OTHER WORK EXCEPT BY AGREEMENT WITH DDA. THERE SHALL BE NO CHANGES OR DEVIATION WITHOUT THE CONSENT OF DDA. WRITTEN CONSENTS SHALL BE BROUGHT TO THE NOTICE OF THE DDA PRIOR TO THE COMMENCEMENT OF ANY WORK.



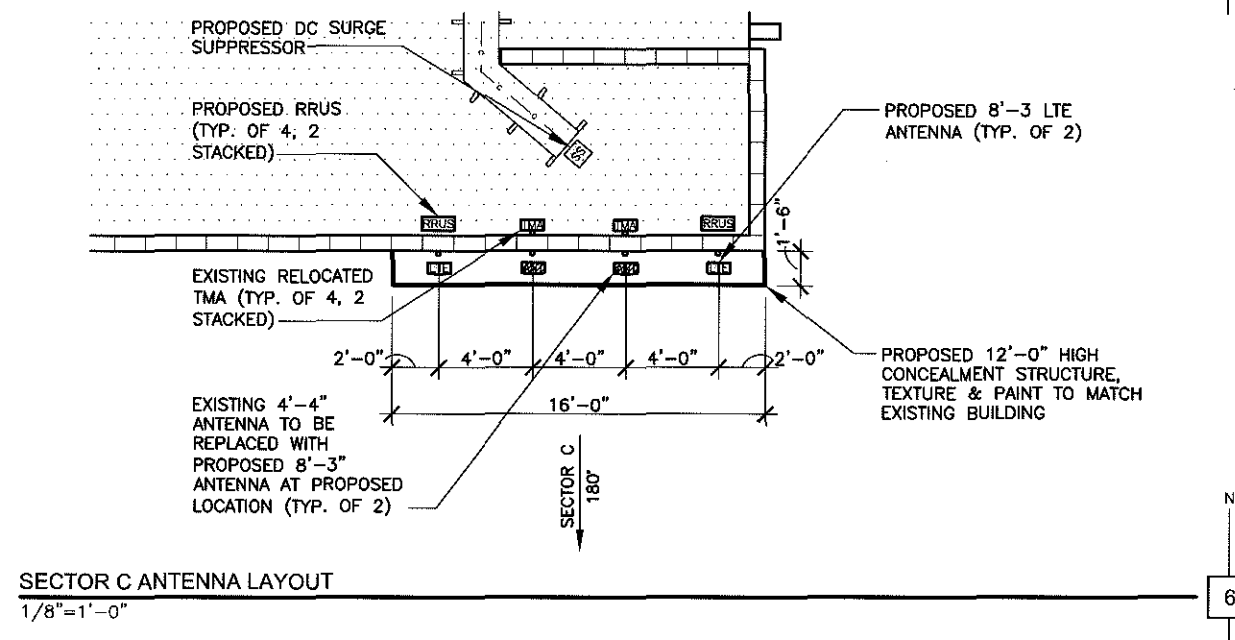
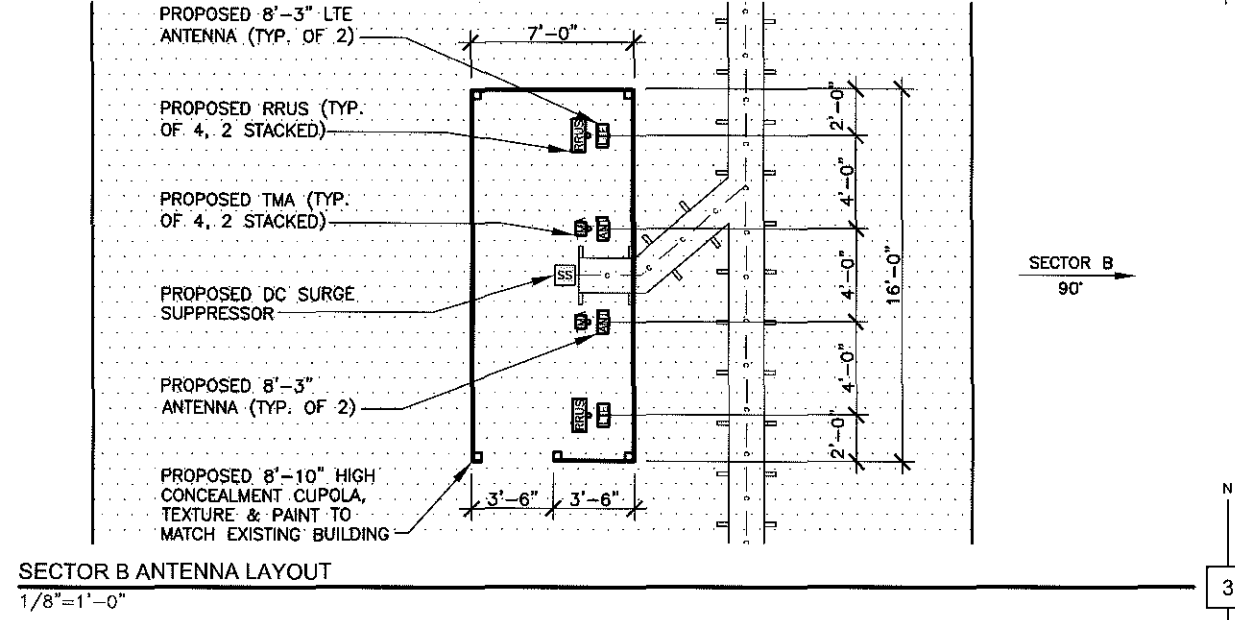
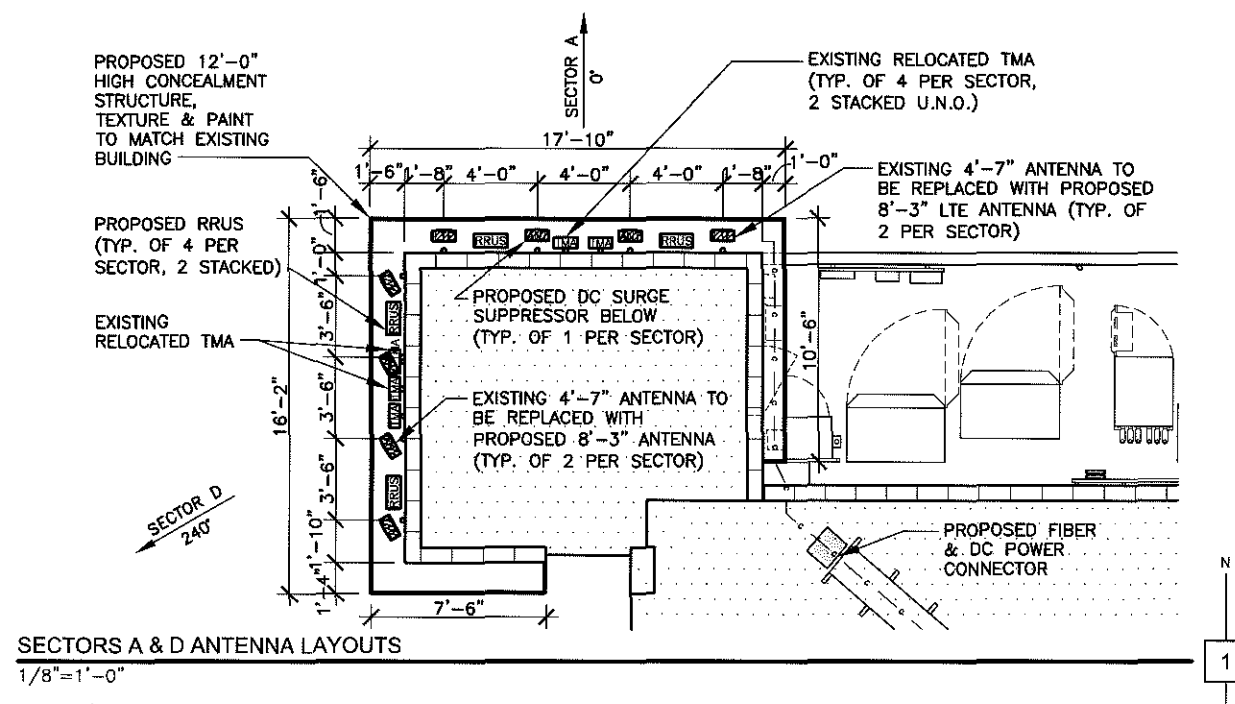

WEIGHT WITH BRACKETS:  
78.7 LBS. (35.7 KG)  
MODEL:  
KATHREIN 800 10766 K

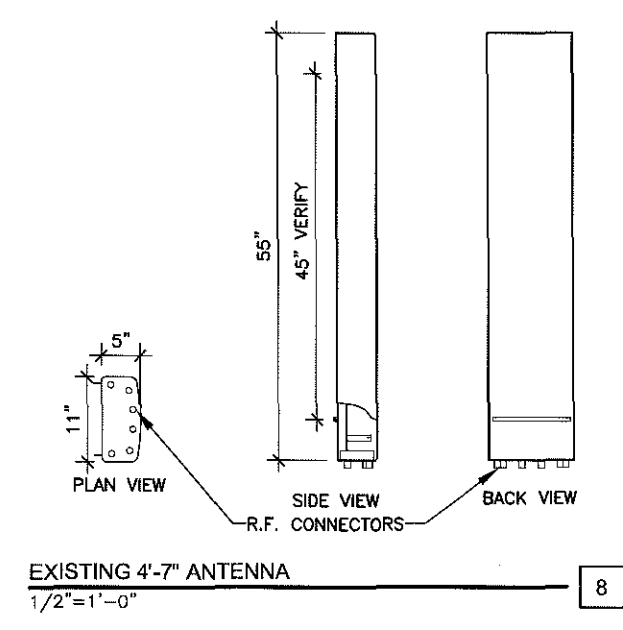
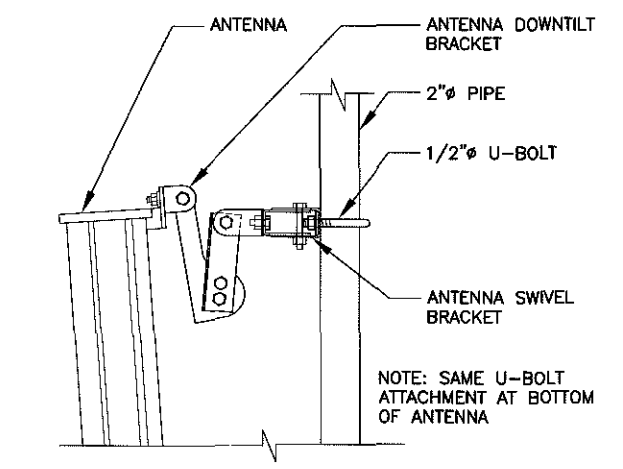
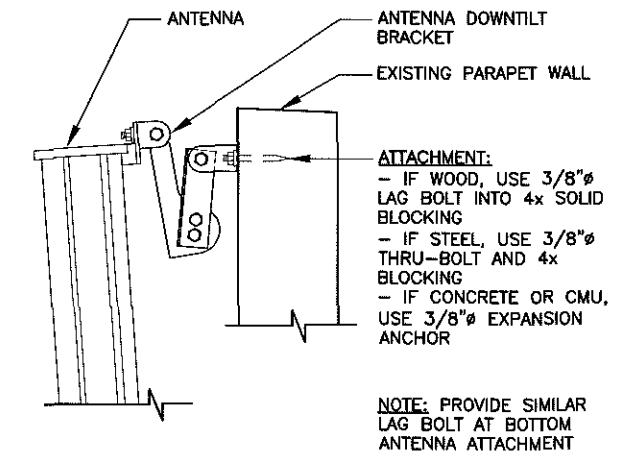
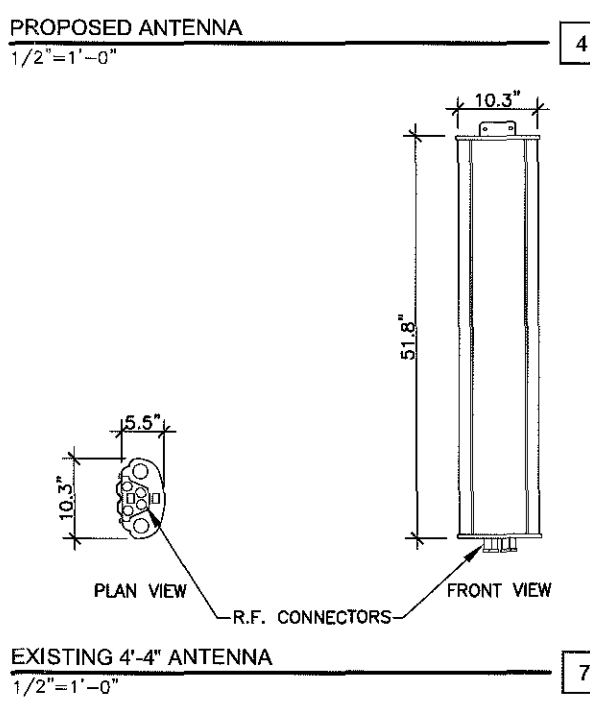
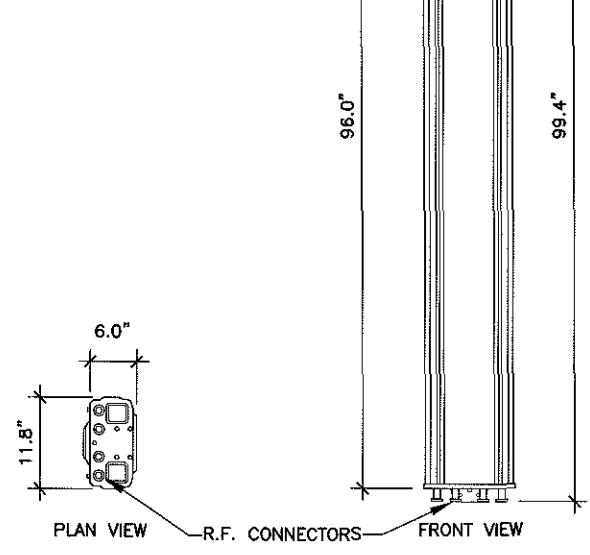

ARCHITECT

**DI DONATO ASSOCIATES**  
ARCHITECTURE + GRAPHICS  
3939 FIRST AVENUE, SUITE 100 - SAN DIEGO, CA 92103  
619.299.4210 • 619.299.4250 FAX • DDAMAIL@AOL.COM

**PROJECT NAME**

**at&t**  
SD0013 LTE OPTIMAL  
2400 SIXTH AVENUE LTE OPTIMAL  
2400 SIXTH AVENUE SAN DIEGO, CA 92101

DATE	ISSUE	DESCRIPTION	BY	CHK	REVISED PER	GPS LOCATION
05-16-11	01					

SHEET INFORMATION

**DI DONATO ASSOCIATES**  
ARCHITECTURE + GRAPHICS

**Z07**  
ANTENNA LAYOUTS, DETAILS

1029.27  
PLOT SCALE 1:1 (11x17 PAPER SIZE)



# 2400 Sixth Avenue

AT&T SITE ID: SD0013

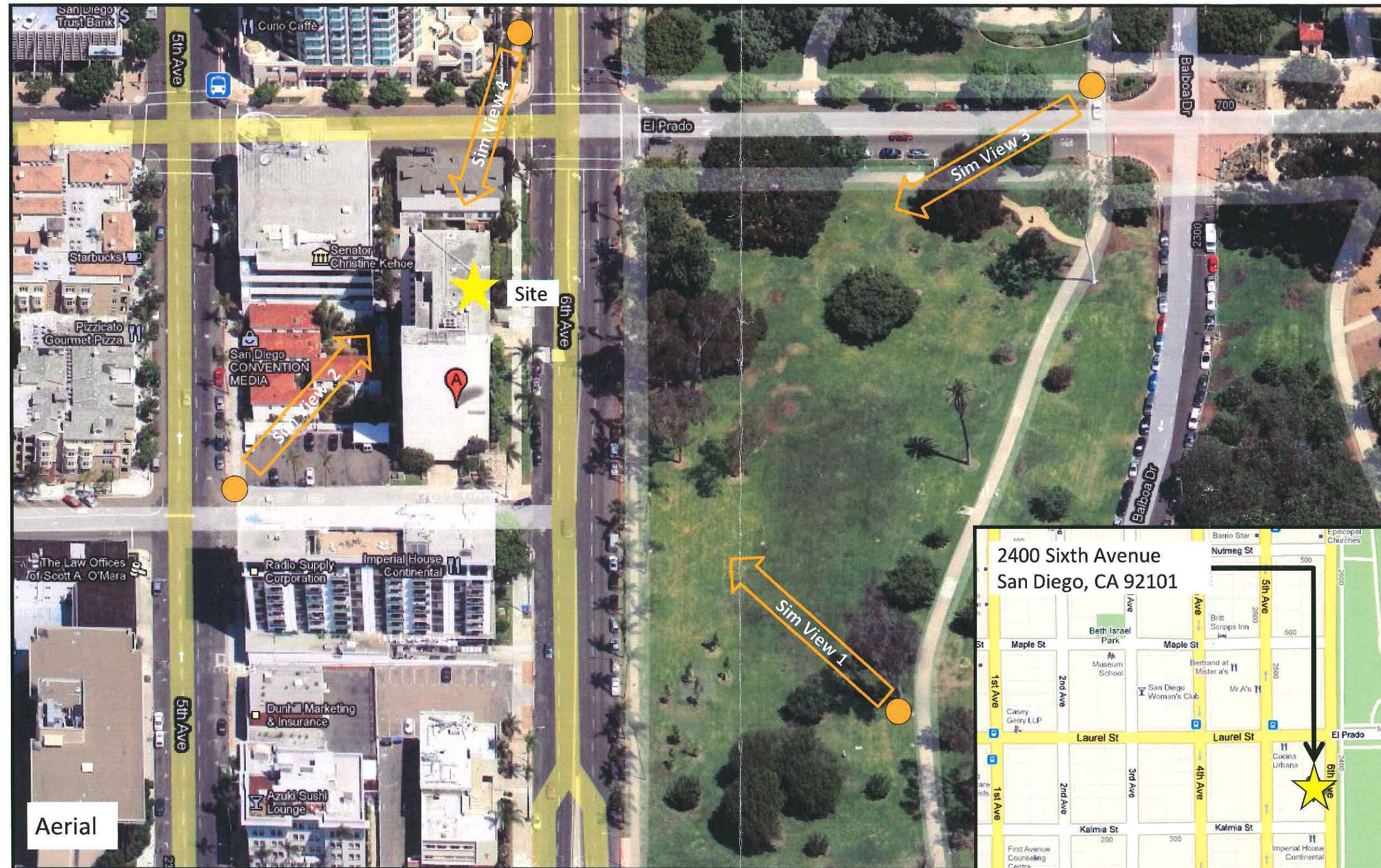

Aerial

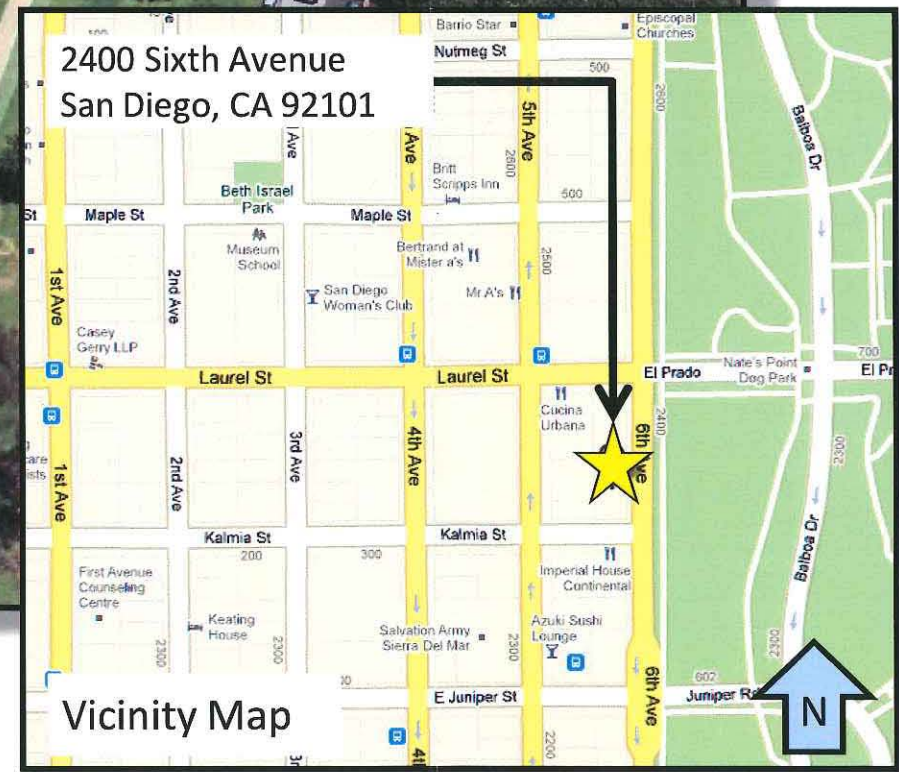

Vicinity Map



# 2400 Sixth Avenue

AT&T SITE ID: SD0013

**View 1**

**Proposed Site**

Proposed (4) AT&T panel antennas located within architecturally integrated FRP enclosure





# 2400 Sixth Avenue

AT&T SITE ID: SD0013

West Elevation

View 2

Proposed (4) AT&T panel antennas located within architecturally integrated FRP enclosure

Proposed Site

Existing Site





# 2400 Sixth Avenue

AT&T SITE ID: SD0013

**View 3**

**Proposed (8) AT&T panel antennas located behind architecturally integrated rooftop cupola**

**Proposed Site**



**Existing Site**





# 2400 Sixth Avenue

AT&T SITE ID: SD0013

**View 4**

Proposed (4) AT&T panel antennas located within architecturally integrated FRP enclosure



**Existing Site**





# Photo Survey

AT&T SD013 / 6<sup>th</sup> Avenue



Subject building and AT&T south sector antenna enclosure

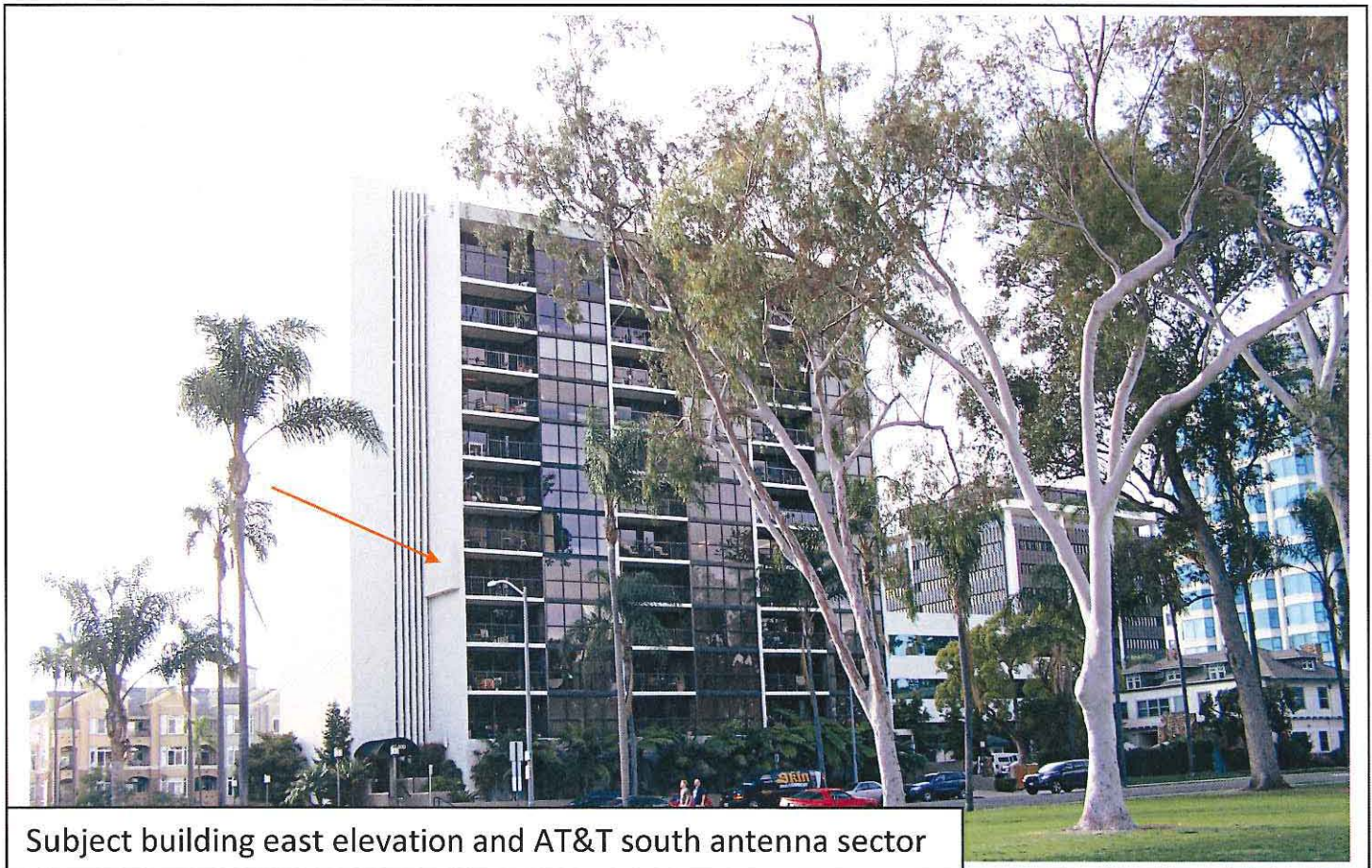

Subject building east elevation and AT&T south antenna sector





AT&T equipment enclosure and north antenna sector

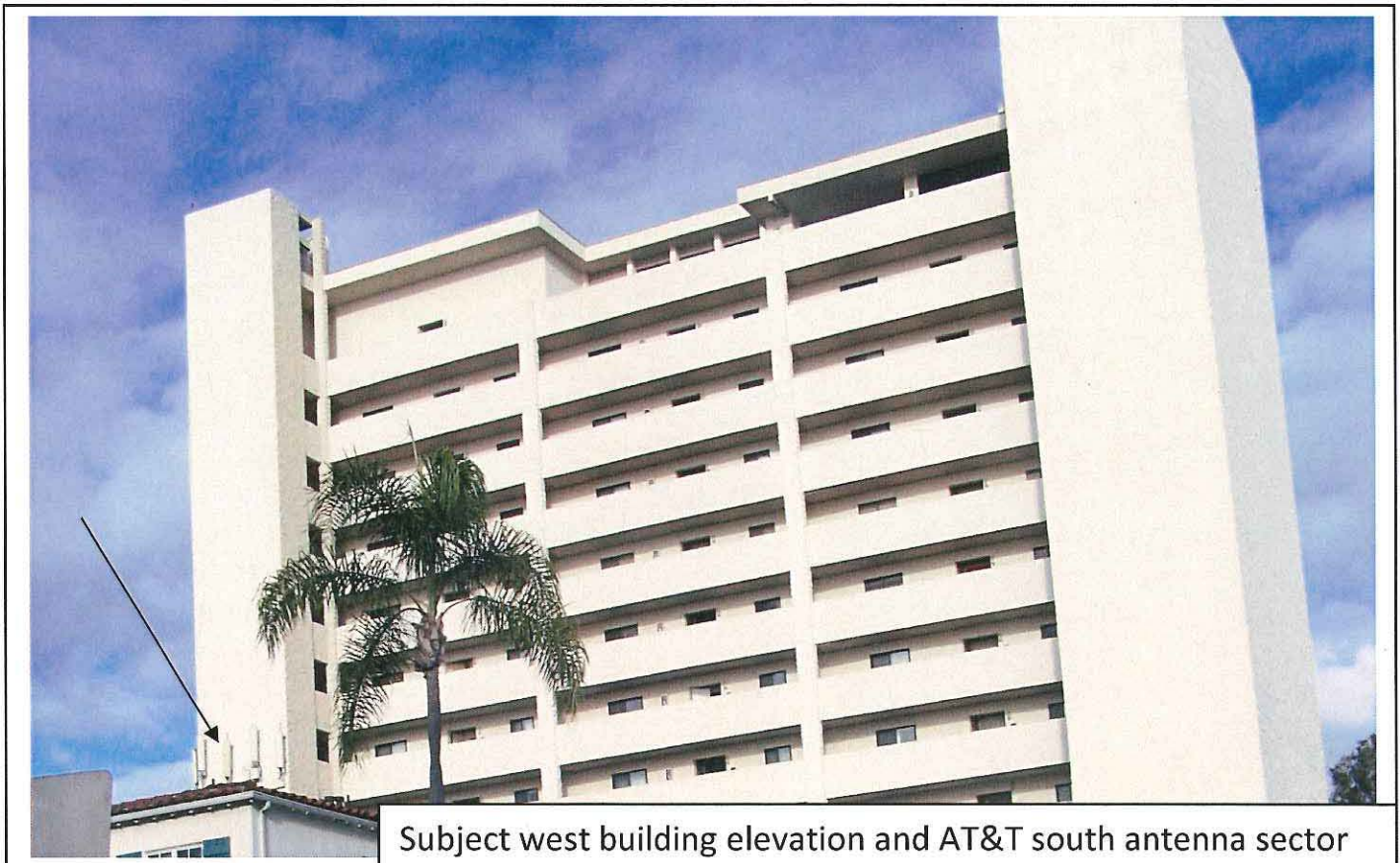

Subject west building elevation and AT&T south antenna sector



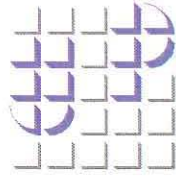

**UPTOWN PLANNERS**  
Uptown Community Planning Group  
**Meeting Minutes**

**April 5, 2011**

Joyce Beers Community Center, Uptown Shopping District

Present: Wilson, (Chair), Butler, Jaworski, Seidel, Liddell, Winney, O'Dea (Late), Tablang, Pesqueira, Adler, Ferrier, Bonn, Bonner, Dahl, Grinchuk, Mellos (late), Lamb (late)

**Board Meeting: Parliamentary Items/ Reports:**

Approval of Agenda: The following Items were removed from the Action Items sections of the agenda and placed on Consent:

Approval of Minutes: The minutes for the March 2011 meeting of Uptown Planners were approved by voice vote.

Election of Officers: Motion by Seidel, second by Bonn, to re-elect Wilson as chair; Liddell as co-chair; Dahl as treasurer; passed by unanimous vote of 14-0. Liddell nominated, Seidel seconded, Jaworski for secretary: Seconded by Seidel. Jaworski unanimously elected by 14-0 vote.

Before voting, the board members reviewed and discussed the memo from the City Attorney's Office regarding the need for a bylaws deviation regarding board election procedure, and the appointment of officers; and the memo in reply by Don Liddell and Leo Wilson pointed out the same deviation would also be required under the former bylaws, and that the present bylaws had been in effect 2007, based on the representation by both the City Attorney's Office and head of the Planning Department at the special City Council meeting that they had been approved. Nevertheless, both Liddell and Wilson stated they would agree to a retroactive deviation request to the City Council, as proposed by the City Attorney memo.

Treasurer's Report

Treasurer Dahl reported the balance in the Uptown Planners bank account.

Website Report: Discussion of need for other board members to participate in the maintenance and upkeep of the website.

Chair/ CPC Report

Chair reports the community gardens issue will come before the CPC.

Issues related to incentives for sustainability and affordable housing are moving to the city council

The retention of two meeting locations for Uptown Planners Board meetings was re-affirmed with the decision to hold the May meeting at the Joyce Beers Community Center

**Public Communications**

Joyce Summers presented an update on activities at the CCDC.

Ann Garwood of the Hillcrest Town Council announced that the upcoming agenda includes a redistricting forum.

Nancy Moors reported that on March 20 a storm toppled a eucalyptus tree onto the Quince Street Bridge, resulting in it being damaged and closed. Moors requested the repair of the bridge be expedited by the city.

Chair Wilson commented on that he wished the City had inserted the deviation clause approved by the Community Planners Committee in the recently approved Medical Marijuana Ordinance.

**Representatives of Elected Officials:**

Courtney Thompson from Third City Council District announced an Easter basket drive for an event to be held at Trolley Barn Park.

Thyme Curtis, the new representative from the Second City Council District, introduced herself and indicated she had worked in the Second District City Council office for over four years. Curtis reported the city was obtaining a cost estimate to repair the Quince Street Bridge, and would attempt to expedite its repair.

Ernie Bonn announced that SANDAG was hosting an April 7<sup>th</sup> meeting at Grace Lutheran Church regarding the Mid City Rapid Bus project

**Consent Agenda:** Action Item: Development Project Review Item 1. Request for Letter of Support by San Diego GLBT Pride for the 37<sup>th</sup> Annual Pride Event on July 16, 2011 moved to Consent.

**REQUEST FOR LETTER OF SUPPORT BY SAN DIEGO GLBT PRIDE FOR THE 37<sup>TH</sup> ANNUAL SAN DIEGO PRIDE EVENT ON JULY 16, 2011.**

Moved to and approved on Consent 16-0-0

**ATT 2400 SIXTH AVENUE AT&T MOBILITY 6<sup>TH</sup> AVENUE LTE SDP & CUP (“BELLAFOINTAINE AT&T SIXTH AVENUE LTE”)** – Bankers Hill/Park West – Process Four – AT&T Mobility is proposing to modify an existing Wireless Communication Facility at 2400 Sixth Avenue, in the MCCPD-MR-800 Zone. The modification is part of a network upgrade for LTE technology. The project as proposed requires a site development permit and conditional use permit

Moved to and approved on Consent 16-0-0; a letter from Tom Fox, President of the HOA at Bellefontaine had been submitted in favor of the project.

Motion to Approve Consent agenda made by Jaworski; Seconded by Ferrier. Approved: 16-0-1 chair abstaining

**Information Items: Projects**

**2001 FOURTH AVENUE (“SHARP REES-STEALY MEDICAL CENTER DOWNTOWN”)** – Process One/ Permits Issued -- Bankers Hill/Park West – Presentation by Don Balfour, MD, President and Medical Director, Sharp Rees-Stealy Medical Group and Patricia Nemeth, Vice President, Facilities, Sharp HealthCare; regarding a new medical office being built on the lot bordered by Grapes Street, Fourth Avenue, Fir Street and Third Avenue. Building designed around historic Florence Hotel Moreton Bay Fig Tree; and includes a 300-space parking garage; project scheduled for completion in the summer of 2012.

In addition to Don Balfour and Patricia Nemeth, also presenting on the topic were Sara Steinhoffer, Sharp VP of Government Affairs, Rick Guinn, Rudolph and Sletten, General Engineering Contractors and

Douglas Austin, of AVRPA, studios, as architects. An informational report was submitted to the board dated April 5, 2011.

The group presented plans for the new medical office building to replace the 88-year old building on 4<sup>th</sup> Ave. Sharp officials said it would be the first LEED Gold-certified medical building in San Diego. The three story building will have 66,365 square feet of medical office space, 300 parking spaces and a history gallery. The first floor will house a pharmacy, optical shop and physical therapy department. Urgent Care, occupational medicine and radiology will be on the second floor. The third floor will be devoted to internal medicine, family medicine and specialty practices. Sharp anticipates a summer 2012 opening.

Parking will be provided to patients for \$1.

Public comment was made by Ben Baltic, who was concerned over the impacts of the project on the adjacent neighborhood; and by Jeannie Rawlings, Nancy Moor.

Board members encouraged Sharp to consider opening the parking facility up to the community after hours to provide a wider community benefit. The Board also reminded Sharp that the facility is NOT located in Downtown San Diego, but rather in Uptown San Diego.

**WATER PURIFICATION SYSTEM** – Presentation by Jennifer Casamassima, Recycling Water Program Manager, and Public Utilities Department, about effort to provide a local and sustainable water supply, the Water Purification Demonstration Project is examining the use of advanced water purification technology to provide safe and reliable water for San Diego's future. The City's 2005 Water Reuse Study identified reservoir augmentation as the preferred option for developing recycled water resources.

A presentation made by city staff regarding the Water Purification Demonstration Project; more information regarding the project can be obtained at [www.purewatersd.org](http://www.purewatersd.org). The presentation was in regard to the need for more water in the San Diego region; and the ability of an advanced water purification process to provide reservoir augmentation for future needs.

**Action Items: Development Project Review:**

**301 UNIVERSITY PARKING LOT EXPANSION** -- Hillcrest – Request for a letter of support for demolition of existing vacant medical office building at 301 University, which would be replaced by an expansion of the existing parking lot, and would add an additional 25 new spaces. The additional parking would remain on a temporary basis pending development of the lot.

Bruce Leidenberger of La Jolla Pacific Development presented a request for non-conforming use in MR-800 to convert the 301 University site into a temporary parking lot adding, 25 new spaces. Proposed pricing to be as follows: 0-2 hours \$3; 2-5 hours \$5; 5-10 hours \$10

Hillcrest Business Association and Hillcrest BID support the parking lot expansion on a temporary basis. Walter Chambers communicates that Hillcrest community members would like more information on how the proposed parking lot will look like and how the operations, cost, etc will impact the vitality of the area; he had also submitted a letter to the board regarding the proposed project.

Motion was made by Seidel, seconded by Grinchuk to approve proposal subject to the following conditions: 1.) Project site should be made attractive with maintained landscaping, lighting and fencing. 2.) The use should be approved for a five year period of term, subject to renewal. The motion passed by a vote of 15-0; voting in favor were Dahl, O'Dea, Seidel, Lamb, Grinchuk, Winney, Ferrier, Jaworski, Tablang, Pesquiera, Butler; Liddell, Bonn, Bonner, Adler and Mellos; non-voting chair abstaining.

**PROPOSED REVISED COMMUNITY GARDEN ZONING ORDINANCE** - Revisions to existing regulations are proposed that would allow community gardens to be approved through a Process One permit, which would be valid for three years. Onsite sales would be allowed for produce grown onsite. All storage, refuse and composting we be required to be located in the center of the site.

Park Troutman spoke in favor of the ordinance, providing the board with some background on the issue. a

Board members expressed concerns over the up-keep and general attractiveness of the individual gardens.

Motion to support the proposed Community Garden Ordinance made by Dahl; seconded by O'Dea; approved by a 11-4-2 vote, with non-voting chair abstaining: voting in favor were Dahl, O'Dea, Seidel, Lamb, Grinchuk, Winney, Ferrier, Jaworski, Tablang, Pesquiera, Butler; voting against were Liddell, Bonn, Bonner, Adler; Mellos abstaining.

**Action Items: Community**

**PARKING METER UTILIZATON IMPROVEMENT PLAN** - Uptown – On March 8, 2011 the City Council adopted an ordinance implementing the Parking Meter Plan. The ordinance amends the Municipal Code to establish an on-street target utilization rate of 85% for parking meters and ensure payment compliance by users of multi-space pay stations. In order to achieve the target utilization rate, the ordinance would authorize performance-based parking meter pricing (variable rates) and flexible meter operating hours as recommended by community-base organizations.

Additionally, the City Council adopted a resolution to amend Council Policy 100-18 to cover all administrative and parking meter related costs before meter revenues are allocated between the City and the Community Parking Districts, and allowed Community Parking Districts to use allocated funds for pedestrian comfort and convenience, or vehicular convenience. The ordinance specifies that CPD Boards or designated advisory groups will monitor meter activity and provide recommendations to the City in order to achieve great utilization rates.

As background Information City of San Diego Report to the City Council, dated February 9, 2011, entitled: "Parking Meter Utilization Improvement Plan" had distributed to the board, as well as the Executive Summary of the report of the Independent Budge Analyst.

The Board discussed the importance of adopting parking management policy that includes oversight by a democratically elected parking board to ensure that the wishes of the community members directly impacted by parking will get the maximum benefit out proposed parking regulations and revenue.

Motion by Liddell, and seconded by Seidel, to oppose implementation of the Parking Utilization Plan in Uptown; voting in favor were; Passed by a 15-1-1 vote; Liddell, Seidel, Dahl, O'Dea, Lamb, Winney, Ferrier, Jaworski, Tablang, Pesquiera, Butler, Bonn, Bonner, Adler, Mellos; Voting against was Grinchuk non-voting chair abstained.

**Adjournment:** meeting adjourned at approximately 8:04 pm.

These minutes respectfully submitted by Board Secretary Beth Jaworski.





City of San Diego  
 Development Services  
 1222 First Ave., MS-302  
 San Diego, CA 92101  
 (619) 446-5000

# Ownership Disclosure Statement

Approval Type: Check appropriate box for type of approval (s) requested:  Neighborhood Use Permit  Coastal Development Permit  
 Neighborhood Development Permit  Site Development Permit  Planned Development Permit  Conditional Use Permit  
 Variance  Tentative Map  Vesting Tentative Map  Map Waiver  Land Use Plan Amendment •  Other \_\_\_\_\_

Project Title: AT&T SD013 / 6th Ave. Project No. For City Use Only  
225054  
 Project Address: 2400 6th, Ave., 92101

**Part I - To be completed when property is held by Individual(s)**

By signing the Ownership Disclosure Statement, the owner(s) acknowledge that an application for a permit, map or other matter, as identified above, will be filed with the City of San Diego on the subject property, with the intent to record an encumbrance against the property. Please list below the owner(s) and tenant(s) (if applicable) of the above referenced property. The list must include the names and addresses of all persons who have an interest in the property, recorded or otherwise, and state the type of property interest (e.g., tenants who will benefit from the permit, all individuals who own the property). A signature is required of at least one of the property owners. Attach additional pages if needed. A signature from the Assistant Executive Director of the San Diego Redevelopment Agency shall be required for all project parcels for which a Disposition and Development Agreement (DDA) has been approved / executed by the City Council. Note: The applicant is responsible for notifying the Project Manager of any changes in ownership during the time the application is being processed or considered. Changes in ownership are to be given to the Project Manager at least thirty days prior to any public hearing on the subject property. Failure to provide accurate and current ownership information could result in a delay in the hearing process.

Additional pages attached  Yes  No

Name of Individual (type or print): \_\_\_\_\_  
 Owner  Tenant/Lessee  Redevelopment Agency  
 Street Address: \_\_\_\_\_  
 City/State/Zip: \_\_\_\_\_  
 Phone No: \_\_\_\_\_ Fax No: \_\_\_\_\_  
 Signature: \_\_\_\_\_ Date: \_\_\_\_\_

Name of Individual (type or print): \_\_\_\_\_  
 Owner  Tenant/Lessee  Redevelopment Agency  
 Street Address: \_\_\_\_\_  
 City/State/Zip: \_\_\_\_\_  
 Phone No: \_\_\_\_\_ Fax No: \_\_\_\_\_  
 Signature: \_\_\_\_\_ Date: \_\_\_\_\_

Name of Individual (type or print): \_\_\_\_\_  
 Owner  Tenant/Lessee  Redevelopment Agency  
 Street Address: \_\_\_\_\_  
 City/State/Zip: \_\_\_\_\_  
 Phone No: \_\_\_\_\_ Fax No: \_\_\_\_\_  
 Signature: \_\_\_\_\_ Date: \_\_\_\_\_

Name of Individual (type or print): \_\_\_\_\_  
 Owner  Tenant/Lessee  Redevelopment Agency  
 Street Address: \_\_\_\_\_  
 City/State/Zip: \_\_\_\_\_  
 Phone No: \_\_\_\_\_ Fax No: \_\_\_\_\_  
 Signature: \_\_\_\_\_ Date: \_\_\_\_\_



Project Title: AT&T SD013 / 6th Ave. Project No. (For City Use Only) 225054

**Part II - To be completed when property is held by a corporation or partnership**

**Legal Status (please check):**

Corporation  Limited Liability -or-  General) What State? \_\_\_\_\_ Corporate Identification No. \_\_\_\_\_  
 Partnership

By signing the Ownership Disclosure Statement, the owner(s) acknowledge that an application for a permit, map or other matter as identified above, will be filed with the City of San Diego on the subject property with the intent to record an encumbrance against the property. Please list below the names, titles and addresses of all persons who have an interest in the property, recorded or otherwise, and state the type of property interest (e.g., tenants who will benefit from the permit, all corporate officers, and all partners in a partnership who own the property). A signature is required of at least one of the corporate officers or partners who own the property. Attach additional pages if needed. Note: The applicant is responsible for notifying the Project Manager of any changes in ownership during the time the application is being processed or considered. Changes in ownership are to be given to the Project Manager at least thirty days prior to any public hearing on the subject property. Failure to provide accurate and current ownership information could result in a delay in the hearing process. Additional pages attached  Yes  No

Corporate/Partnership Name (type or print): \_\_\_\_\_

Owner  Tenant/Lessee

Street Address: Suite 204  
3737 5th. Ave.

City/State/Zip: San Diego, CA, 92101

Phone No: 619-295-8711 Fax No: 619-296-4640

Name of Corporate Officer/Partner (type or print): Al Simonelli for Bellefontaine Condo Ownership Association

Title (type or print): Agent for HOA

Signature: Xcel Swartz Date: 9-2-09

Corporate/Partnership Name (type or print): \_\_\_\_\_

Owner  Tenant/Lessee

Street Address: \_\_\_\_\_

City/State/Zip: \_\_\_\_\_

Phone No: \_\_\_\_\_ Fax No: \_\_\_\_\_

Name of Corporate Officer/Partner (type or print): \_\_\_\_\_

Title (type or print): \_\_\_\_\_

Signature: \_\_\_\_\_ Date: \_\_\_\_\_

Corporate/Partnership Name (type or print): \_\_\_\_\_

Owner  Tenant/Lessee

Street Address: \_\_\_\_\_

City/State/Zip: \_\_\_\_\_

Phone No: \_\_\_\_\_ Fax No: \_\_\_\_\_

Name of Corporate Officer/Partner (type or print): \_\_\_\_\_

Title (type or print): \_\_\_\_\_

Signature: \_\_\_\_\_ Date: \_\_\_\_\_

Corporate/Partnership Name (type or print): \_\_\_\_\_

Owner  Tenant/Lessee

Street Address: \_\_\_\_\_

City/State/Zip: \_\_\_\_\_

Phone No: \_\_\_\_\_ Fax No: \_\_\_\_\_

Name of Corporate Officer/Partner (type or print): \_\_\_\_\_

Title (type or print): \_\_\_\_\_

Signature: \_\_\_\_\_ Date: \_\_\_\_\_

Corporate/Partnership Name (type or print): \_\_\_\_\_

Owner  Tenant/Lessee

Street Address: \_\_\_\_\_

City/State/Zip: \_\_\_\_\_

Phone No: \_\_\_\_\_ Fax No: \_\_\_\_\_

Name of Corporate Officer/Partner (type or print): \_\_\_\_\_

Title (type or print): \_\_\_\_\_

Signature: \_\_\_\_\_ Date: \_\_\_\_\_

Corporate/Partnership Name (type or print): \_\_\_\_\_

Owner  Tenant/Lessee

Street Address: \_\_\_\_\_

City/State/Zip: \_\_\_\_\_

Phone No: \_\_\_\_\_ Fax No: \_\_\_\_\_

Name of Corporate Officer/Partner (type or print): \_\_\_\_\_

Title (type or print): \_\_\_\_\_

Signature: \_\_\_\_\_ Date: \_\_\_\_\_

## NOTICE OF EXEMPTION

TO:  RECORDER/COUNTY CLERK  
 P.O. BOX 1750, MS A-33  
 1600 PACIFIC HWY, ROOM 260  
 SAN DIEGO, CA 92101-2422

FROM: CITY OF SAN DIEGO  
 DEVELOPMENT SERVICES DEPARTMENT  
 1222 FIRST AVENUE, MS 501  
 SAN DIEGO, CA 92101

\_\_\_\_ OFFICE OF PLANNING AND RESEARCH  
 1400 TENTH STREET, ROOM 121  
 SACRAMENTO, CA 95814

PROJECT NO.: 225054

PROJECT TITLE: AT&T Mobility 6<sup>th</sup> Ave. LTE

PROJECT LOCATION-SPECIFIC: 2400 Sixth Avenue, San Diego, CA 92101

PROJECT LOCATION-CITY/COUNTY: San Diego/San Diego

DESCRIPTION OF NATURE AND PURPOSE OF THE PROJECT: SITE DEVELOPMENT PERMIT AND CONDITIONAL USE PERMIT for modifications of an existing Wireless Communication Facility (WCF). The project proposes the following: Ten (10) previously approved antennas are to be replaced and relocated; six (6) antennas are to be added to the existing residential condominium building (all sixteen to be screened by new cupola and concealment screens); the addition of outdoor equipment cabinets within an existing equipment enclosure; and the relocation of sixteen (16) TMA's. The project would also add one (1) new GPS antenna; eight (8) new TMA's; eight (8) new RRU's; and four (4) new surge suppressors. The project is located within the MCCPD-MR-800 zone of the Uptown Community Planning area of Council District 2.

NAME OF PUBLIC AGENCY APPROVING PROJECT: City of San Diego

NAME OF PERSON OR AGENCY CARRYING OUT PROJECT: Courtney Hall  
 TAIC  
 5473 Kearny Villa Road, Ste. 300  
 San Diego, CA 92123  
 858-472-2168

EXEMPT STATUS: (CHECK ONE)

- MINISTERIAL (SEC. 21080(b)(1); 15268);  
 DECLARED EMERGENCY (SEC. 21080(b)(3); 15269(a));  
 EMERGENCY PROJECT (SEC. 21080(b)(4); 15269 (b)(c))  
 CATEGORICAL EXEMPTION: 15301: EXISTING FACILITIES & 15303: NEW CONSTRUCTION

REASONS WHY PROJECT IS EXEMPT: Section 15301 allows for the operation, repair, maintenance, permitting, leasing, licensing or minor alterations of existing public or private structures or facilities involving negligible or no expansion of use. Section 15303 allows for the construction and location of limited numbers of new, small facilities. None of the exceptions listed in CEQA Guidelines Section 15003.2 apply, therefore this exemption is applicable to the proposed project.

LEAD AGENCY CONTACT PERSON: M. Blake

TELEPHONE: (619) 446-5375

IF FILED BY APPLICANT:

1. ATTACH CERTIFIED DOCUMENT OF EXEMPTION FINDING.
2. HAS A NOTICE OF EXEMPTION BEEN FILED BY THE PUBLIC AGENCY APPROVING THE PROJECT?  
 YES  NO

IT IS HEREBY CERTIFIED THAT THE CITY OF SAN DIEGO HAS DETERMINED THE ABOVE ACTIVITY TO BE EXEMPT FROM CEQA

*M. Blake*  
 SIGNATURE/TITLE

3/15/2011  
 DATE

CHECK ONE:

- SIGNED BY LEAD AGENCY  
 SIGNED BY APPLICANT

DATE RECEIVED FOR FILING WITH COUNTY CLERK OR OPR:



THE CITY OF SAN DIEGO

DATE OF NOTICE: March 12, 2012

# NOTICE OF PUBLIC HEARING PLANNING COMMISSION

---

<b>DATE OF HEARING:</b>	<b>March 29, 2012</b>
<b>TIME OF HEARING:</b>	<b>9:00 A.M.</b>
<b>LOCATION OF HEARING:</b>	<b>Council Chambers, 12th Floor, City Administration Building, 202 C Street, San Diego, California 92101</b>
<b>PROJECT TYPE:</b>	<b>SITE DEVELOPMENT PERMIT &amp; CONDITIONAL USE PERMIT - PROCESS LEVEL 4</b>
<b>PROJECT NUMBER:</b>	<b>225054</b>
<b>PROJECT NAME:</b>	<b><u>AT&amp;T MOBILITY SIXTH AVENUE LTE</u></b>
<b>APPLICANT:</b>	<b>Jim Kennedy</b>
<b>COMMUNITY PLAN AREA:</b>	<b>Uptown</b>
<b>COUNCIL DISTRICT:</b>	<b>District 2</b>
<b>CITY PROJECT MANAGER:</b>	<b>SIMON TSE, Associate Planner</b>
<b>PHONE NUMBER:</b>	<b>(619) 687-5984</b>

---

As a property owner, tenant or person who has requested notice, you should know that the Planning Commission will hold a public hearing to approve, conditionally approve, or deny an application for a modification to an existing Wireless Communication Facility (WCF) consisting of sixteen (16) panel antennas. The equipment associated with the project modification will continue to operate on the second story above the parking garage inside a 275-square foot enclosure equipment platform, not visible to the public. The project is located at 2400 Sixth Avenue in the Mid Cities Community Planned District (MCCPD) MR-800 zone of the Uptown Community Plan.

The decision of the Planning Commission is final unless the project is appealed to the City Council. In order to appeal the decision of the Planning Commission you must be present at the public hearing and file a speaker slip concerning the application or have expressed interest by writing to the Planning Commission before the close of the public hearing. See Information Bulletin 505 "Appeal Procedure", available at [www.sandiego.gov/development-services](http://www.sandiego.gov/development-services) or in person at the office of the City Clerk, 202 "C" Street, Second Floor. The appeal must be made within 10 working days of the Planning

Commission decision. If you wish to challenge the City's action on the above proceedings in court, you may be limited to addressing only those issues you or someone else have raised at the public hearing described in this notice, or written in correspondence to the City at or before the public hearing.

This project was determined to be categorically exempt from the California Environmental Quality Act.

If you have any questions after reviewing this information, you can contact the City Project Manager listed above.

This information will be made available in alternative formats upon request. To request an agenda in alternative format or to request a sign language or oral interpreter for the meeting, call Support Services at (619) 321-3208 at least five working days prior to the meeting to insure availability. Assistive Listening Devices (ALD's) are also available for the meeting upon request.

Internal Order No. 24001305

Revised 12/5/08 RH

**AT&T Mobility Sixth Avenue LTE**  
**PROJECT CHRONOLOGY**  
**PTS #225054 INT #24001305**

Date	Action	Description	City Review	Applicant Response
<b>11.16.2010</b>	<b>First Submittal</b>	<b>Project Deemed Complete</b>		
12.21.2010	First Assessment Letter		<b>28 days</b>	
1.27.2011	Second Submittal			<b>37 days</b>
3.23.2011	Second Assessment Letter		<b>55 days</b>	
3.29.2011	Third Submittal			<b>6 days</b>
2.3.2012	All issues resolved	Pending FAA Determination of No Hazard to Air Navigation form.		<b>310 days</b>
3.29.2012	Scheduled for Planning Commission		<b>55 days</b>	
<b>Total Staff Time:</b>		Including City Holidays and Furlough	<b>138 days</b>	
<b>Total Applicant Time:</b>		Including City Holidays and Furlough		<b>353 days</b>
<b>Total Project Running Time:</b>		From Deemed Complete to PC Hearing	<b>591 days</b>	