



THE CITY OF SAN DIEGO

REPORT TO THE PLANNING COMMISSION

DATE ISSUED: April 18, 2013 **REPORT NO. PC-13-043**

ATTENTION: Planning Commission, Agenda of April 25, 2013

SUBJECT: AT&T – ENCANTO SKYLINE - PROJECT NO. 280764.
PROCESS 4

**OWNER/
APPLICANT:** City of San Diego
Verizon Wireless.

SUMMARY

Issue(s): Should the Planning Commission approve a Wireless Communication Facility (WCF) located at 6780 Aviation Drive within the Skyline Paradise Hills Community Plan area?

Staff Recommendation:

1. Approve Conditional Use Permit No.1105583; and
2. Approve Planned Development Permit No. 1105585

Community Planning Group Recommendation: On June 12, 2012, the Skyline – Paradise Hills Planning Committee voted 7-0 to recommend approval of the AT&T – Encanto Skyline project with no conditions (Attachment 11).

Environmental Review: This project is not pending an appeal of the environmental determination. This project is exempt from environmental review pursuant to Article 19, Section 15303, New Construction. The environmental exemption determination for this project was made on March 8, 2013 and the opportunity to appeal that determination ended March 22, 2013 (Attachment 10).

Fiscal Impact Statement: All project related costs associated with processing this permit are paid out of a deposit account maintained by the applicant.

Code Enforcement Impact: None.

Housing Impact Statement: Not Applicable.

BACKGROUND

This project proposes a 50-foot high faux pine tree supporting twelve AT&T antennas and a 228-square foot equipment enclosure on a City Water Department property located at 6780 Aviation Drive. The application also includes a new equipment shelter (Attachment 8). The property is zoned RS-1-7 and is located in the Skyline-Paradise Hills community planning area (Attachment 2). The site is on a hilltop surrounded by single family homes (Attachments 1, 2, and 3). WCF's are permitted in the RS-1-7 zone with a CUP. Because the height is proposed at 50-feet, where the maximum height allowed is 30-feet, a PDP is required.

The property once supported a water tank, which was dismantled and removed several years ago and is now home to various communication facilities. Currently on site, there are two other 50-foot tall faux pine trees operated by Sprint and T-Mobile. The City has a 105-foot tall communication tower on site and Verizon has a 133-foot tall monopole that is the subject of a settlement agreement and will be before the Planning Commission next month (Attachment 9).

The addition of landscaping will help to integrate all of the facilities into the hilltop setting and the other faux trees will become less visible to the surrounding community.

DISCUSSION

In order to allow a deviation to the 30-foot height limit, findings for the PDP must be made in the affirmative. PDP finding no. 3 specifically addresses the deviation request stating that, "The proposed development will comply with the regulations of the Land Development Code including any proposed deviations pursuant to Section 126.0602(b)(1) that are appropriate for this location and will result in a more desirable project than would be achieved if designed in strict conformance with the development regulations of the applicable zone; and any allowable deviations that are otherwise authorized pursuant to the Land Development Code."

AT&T has identified a significant gap in coverage in this primarily residential area (Attachment 7). Their search ring identified this non-residential property that is elevated above the residential area they are targeting. The centerline of the antennas is proposed at approximately 40-feet, which will achieve their coverage objective with a single installation, minimizing wireless proliferation in the community (Attachment 8). Additionally, the Telecommunication Act of 1996 does not permit local governments to discriminate against functionally equivalent services and since Sprint and T-Mobile both have 50-foot tall faux trees on site, AT&T's faux tree is appropriate at this location and would result in a more desirable project than would be achieved if the project was designed in strict conformance with the WCF Design Requirements. Detailed findings have been made in the affirmative for this project and are provided in Attachment 5.

Community Plan Analysis:

The Skyline – Paradise Hills Community Plan does not specifically address WCF's. However, the City's General Plan, Section UD-A.15, does address WCF's as follows:

Minimize the visual impact of wireless facilities.

- a) Conceal wireless facilities in existing structures when possible, otherwise use camouflage and screening techniques to hide or blend them into the surrounding area.
- b) Design facilities to be aesthetically pleasing and respectful of the neighborhood context.
- c) Conceal mechanical equipment and devices associated with wireless facilities in underground vaults or unobtrusive structures.

This project complies with the requirements of the General Plan for WCF's. The project proposes a 50-foot tall faux pine tree supporting 12 panel antennas and an equipment enclosure. The tree foliage will screen the antennas and the additional landscaping, as well as the existing faux trees will help to integrate the AT&T WCF into the property.

Conclusion:

Staff has reviewed the project and has determined that it complies with the Wireless Communication Facility regulations. Except for the height of the proposed faux tree, the project complies with all other development regulations of the RS-1-7 zone. The antennas will be interspersed within the faux tree and covered with pine needle socks to further incorporate the antennas into the overall design and make them less visible. The location of the tree on a hilltop along with the other faux trees and the proposed live trees will create a well integrated perspective to the surrounding community below. Therefore, Staff recommends approval of this project.

ALTERNATIVES

1. **Approve CUP No. 1105583 and PDP No. 1105585, with modifications.**
2. **Deny CUP No. 1105583 and PDP No. 1105585, if the Planning Commission makes written findings based on substantial evidence that the approval is not authorized by state or local zoning law.**

Respectfully submitted,



Mike Westlake
Assistant Deputy Director
Development Services Department

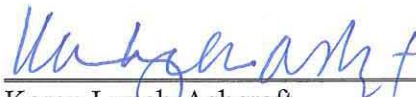

Karen Lynch-Ashcraft
Project Manager
Development Services Department

BROUGHTON/KLA

Attachments:

1. Aerial Photograph
2. Community Plan Land Use Map
3. Project Location Map
4. Project Data Sheet
5. Draft Permit Resolution with Findings
6. Draft Permit with Conditions
7. Coverage Maps
8. Photosimulations
9. Surrounding Photos
10. Environmental Exemption
11. Community Planning Group Recommendation
12. Project Chronology
13. Project Plans

Rev 01-06/11 hmd

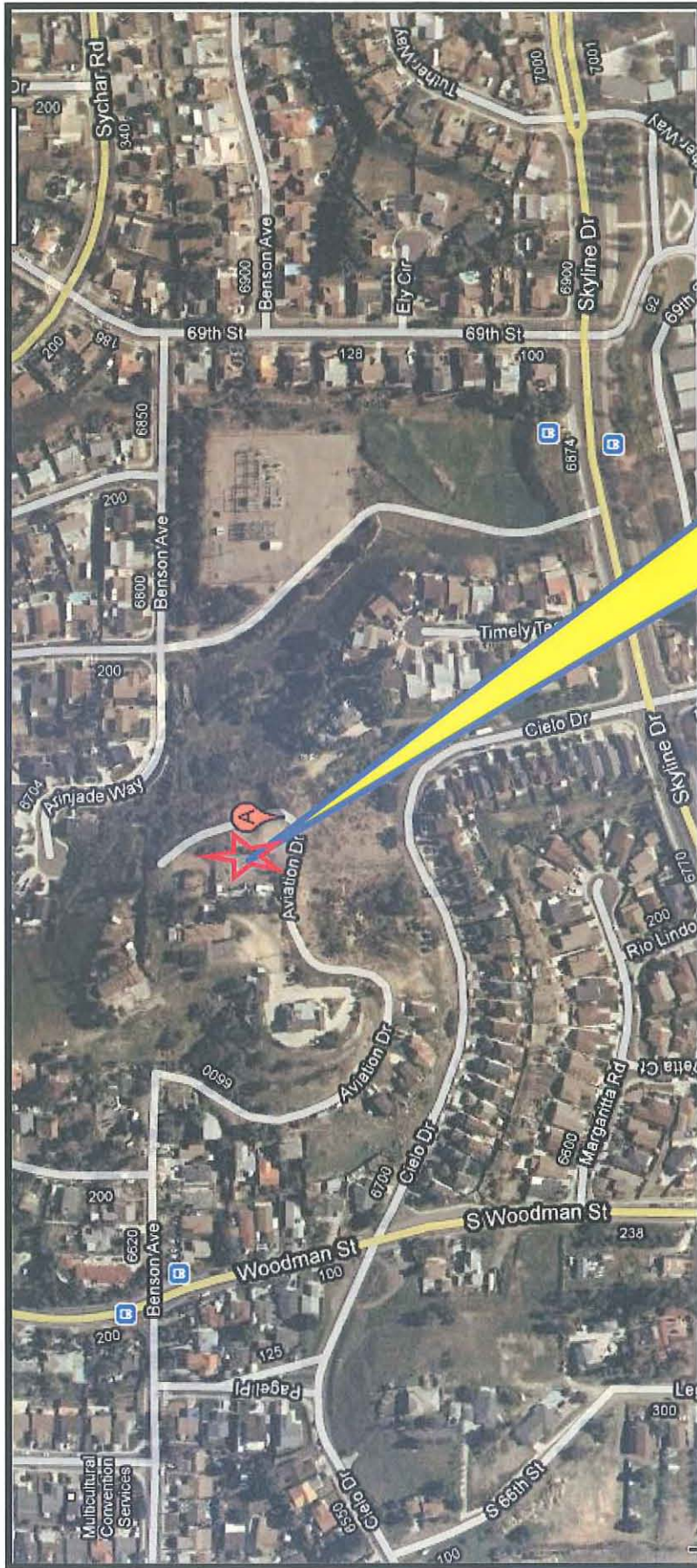

PROJECT SITE



Aerial Photo

AT&T – ENCANTO SKYLINE – PROJECT NUMBER 280764

6780 AVIATION DRIVE



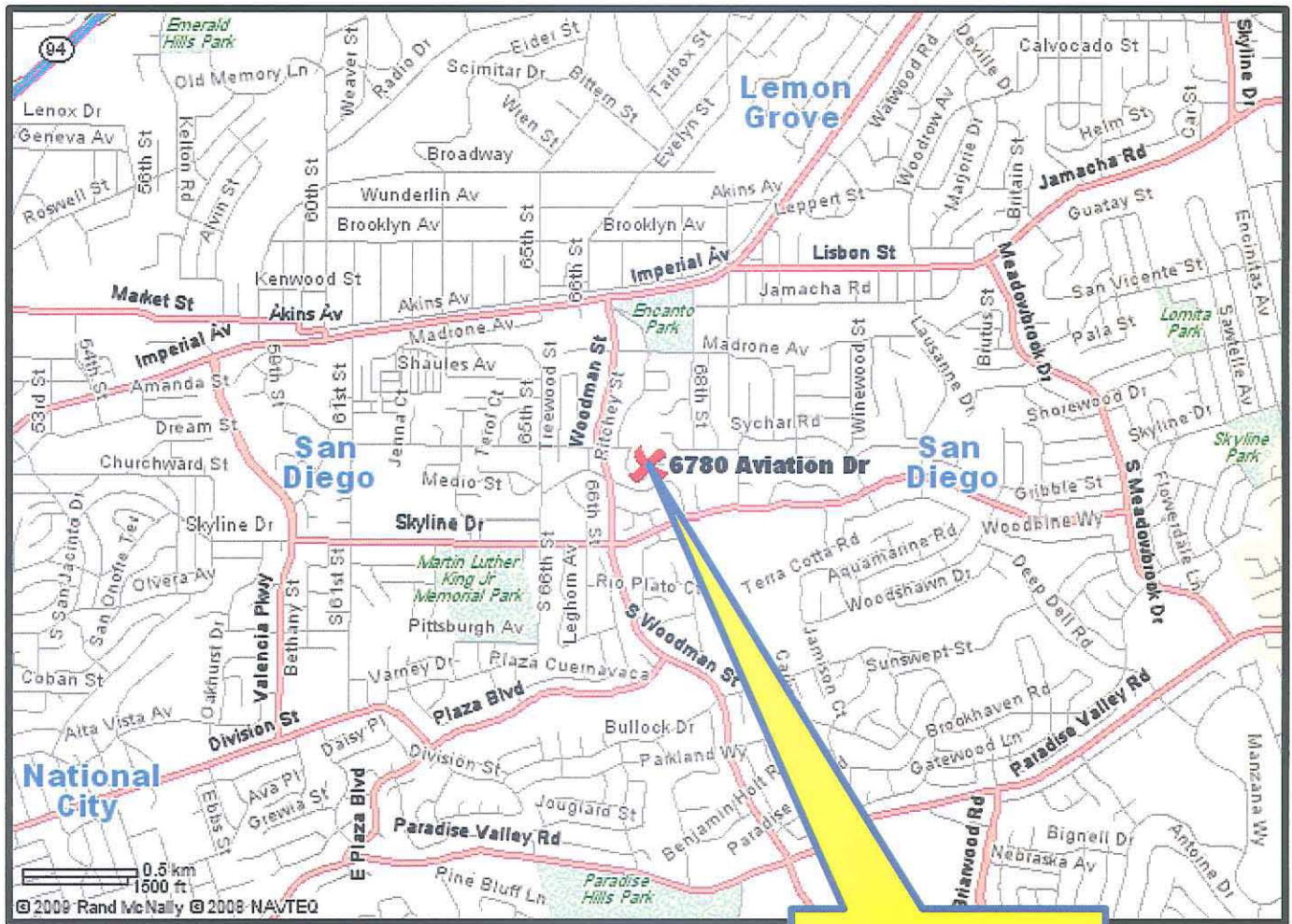

Project Location Map

AT&T – ENCANTO SKYLINE – PROJECT NUMBER 280764
 6780 AVIATION DRIVE

PROJECT SITE



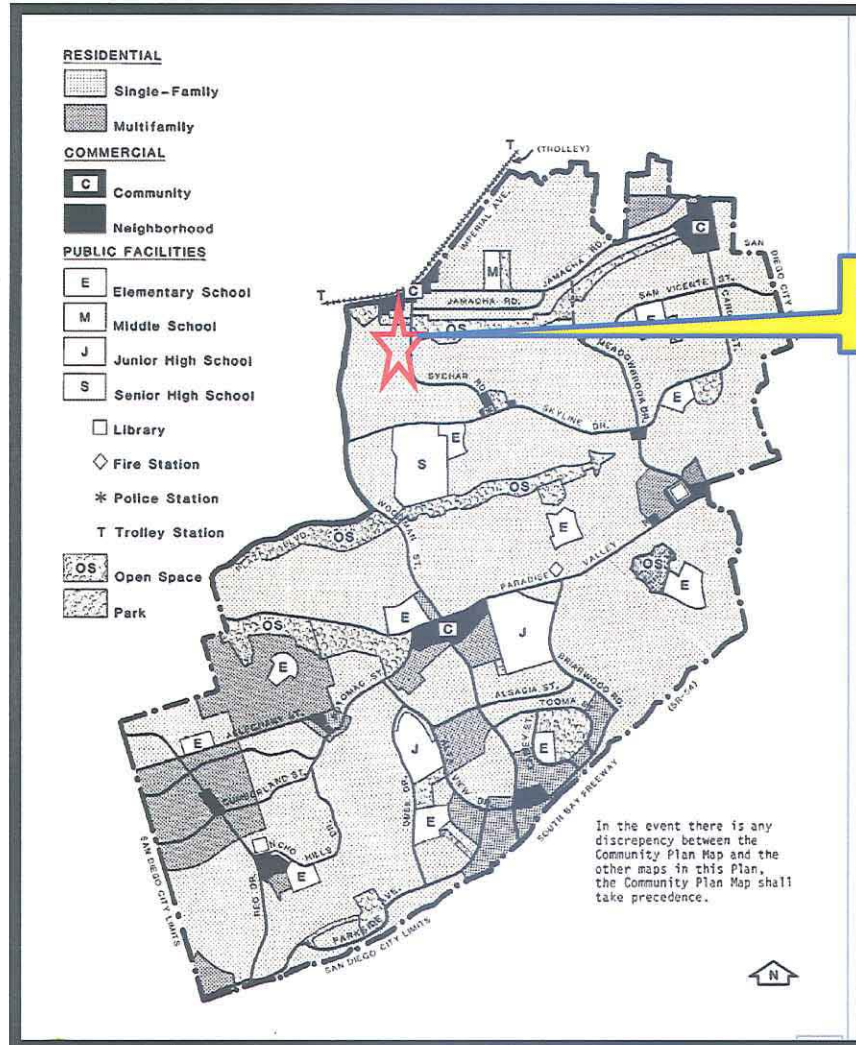

SKYLINE PARADISE HILLS COMMUNITY PLAN MAP

AT&T – ENCANTO SKYLINE – PROJECT NUMBER 280764

6780 AVIATION DRIVE



PROJECT DATA SHEET

PROJECT NAME:	AT&T – Encanto Skyline	
PROJECT DESCRIPTION:	A wireless communication facility consisting of a 50-foot tall faux pine tree supporting 12 panel antennas with an associated equipment enclosure.	
COMMUNITY PLAN AREA:	Skyline-Paradise Hills	
DISCRETIONARY ACTIONS:	Conditional Use Permit, Planned Development Permit	
COMMUNITY PLAN LAND USE DESIGNATION:	Single-Family Residential	
<u>ZONING INFORMATION:</u>		
ZONE: RS-1-7		
HEIGHT LIMIT: 30-Foot maximum height limit.		
FRONT SETBACK: 15 feet.		
SIDE SETBACK: 4 feet.		
STREETSIDE SETBACK: 12 feet.		
REAR SETBACK: 13 feet.		
<u>ADJACENT PROPERTIES:</u>	LAND USE DESIGNATION & ZONE	EXISTING LAND USE
NORTH:	Single-Family Residential; RS-1-7.	Single-Family Residential
SOUTH:	Single-Family Residential; RS-1-7.	Vacant
EAST:	Single-Family Residential; RS-1-7.	Vacant
WEST:	Single-Family Residential; RS-1-7.	Single-Family Residential
DEVIATIONS OR VARIANCES REQUESTED:	Deviation to exceed the 30-foot height limit with a 50-foot high faux tree.	
COMMUNITY PLANNING GROUP RECOMMENDATION:	On June 12, 2012, the Skyline-Paradise Hills Planning Committee voted 7-0 to recommend approval of the AT&T – Encanto Skyline project with no conditions.	

**PLANNING COMMISSION
RESOLUTION NO.
CONDITIONAL USE PERMIT NO. 1105583
PLANNED DEVELOPMENT PERMIT NO. 1105585
AT&T – ENCANTO SKYLINE
PROJECT NO. 280764
DRAFT**

WHEREAS, CITY OF SAN DIEGO, Owner and AT&T MOBILITY, Permittee, filed an application with the City of San Diego for a permit for a wireless communication facility (as described in and by reference to the approved Exhibits "A" and corresponding conditions of approval for the associated Permit No.'s 1105583 and 1105585 on portions of a .563-acre site;

WHEREAS, the project site is located at 6780 Aviation Drive in the RS-1-7 zone of the Skyline – Paradise Hills Community Plan;

WHEREAS, the project site is legally described as: That Portion of Lot 162, Encima De San Diego, in the City of San Diego County of San Diego, State of California, according to Map thereof No. 1546, filed in the Office of the County Recorder of San Diego County, March 18, 1913, lying southerly from a line drawn parallel with a distant 60.00feet southerly from the southerly line of Benson Avenue as shown on said Map No. 1546, and easterly from the following described line: Commencing at the point of intersection of the southerly line of said Benson Avenue with the southwesterly line of Aviation Drive, formerly Lot 1, as shown on said Map No. 1546; thence along the southerly line of said Benson Avenue North 89°11' west a distance of 65.00 feet to a point; thence south 0°49' west a distance of 60.00 feet to the true point of commencement; thence continuing south 0°49' west 181 feet, more or less to an intersection with the center line of said Aviation Drive;

WHEREAS, on April 25, 2013, the Planning Commission of the City of San Diego considered Conditional Use Permit No. 1105583 and Planned Development Permit No. 1105585 pursuant to the Land Development Code of the City of San Diego;

WHEREAS, on March 8, 2013, the City of San Diego, as Lead Agency, through the Development Services Department, made and issued an Environmental Determination that the project is exempt from the California Environmental Quality Act (CEQA) (Public Resources Code section 21000 et. seq.) under CEQA Guideline Section 15303 and there was no appeal of the Environmental Determination filed within the time period provided by San Diego Municipal Code Section 112.0520;

BE IT RESOLVED by the Planning Commission of the City of San Diego as follows:

That the Planning Commission adopts the following written Findings, dated April 25, 2013.

FINDINGS:

Findings for Conditional Use Permit Approval – Section §126.0305

1. The proposed *development* will not adversely affect the applicable *land use plan*;

The Skyline-Paradise Hills Community Plan does not address wireless communication facilities as a specific land use, however, the City of San Diego's General Plan (UD-15) requires that the visual impact of wireless facilities be minimized by concealing wireless facilities in existing structures or using screening techniques to hide or blend them into the surrounding area. The plan also calls for these facilities to be designed to be aesthetically pleasing and respectful of the neighborhood context. Furthermore, the plan states that equipment associated with wireless facilities be concealed from view. The antennas associated with this wireless facility are proposed to be covered with pine needle socks and mounted on a monopine located on a hilltop above the Skyline Paradise Hills community. The addition of landscape material adjacent to the facility will serve to blend the project into the surroundings. Equipment associated with this facility will be located within a prefabricated enclosure with lattice covered sides to assist with landscape growth on the east side where they may be views from the residential below. The AT&T pine tree will be consistent with the design of the other two 50-foot tall faux pine trees currently on site. Therefore, the proposed development would not adversely affect the Skyline-Paradise Hills Community Plan nor the City of San Diego General Plan and Progress Guide.

2. The proposed *development* will not be detrimental to the public health, safety, and welfare;

The Telecommunication Act of 1996 preempts local governments from regulating the "placement, construction and modification of wireless communication facilities on the basis of the environmental effects of Radio Frequency (RF) emissions to the extent that such facilities comply with the Federal Communication Commission's (FCC) standards for such emissions." As noted in the Cumulative RF Report, dated July 14, 2012, the facility will comply with the FCC Guidelines for public safety. Therefore, based on the above, the project would not result in any significant health or safety risks to the surrounding area within the jurisdiction of the City.

3. The proposed *development* will comply with the regulations of the Land Development Code including any allowable deviations pursuant to the Land Development Code; and

This project complies with the regulations of the Land Development Code, specifically the WCF Regulations, LDC 141.0420. WCF's are permitted in residential zones with a non-residential use with the processing of a Conditional Use Permit when the antennas are located less than 100-feet from the property line of a residential use. At 50-feet in height, the project deviates from the development regulations of the RS-1-7 zone for height, which is 30-feet. The project requires a Planned Development Permit to allow for this deviation.

The WCF Design Requirements state that WCF's shall utilize the smallest, least visually intrusive antennas, components, and other necessary equipment. Furthermore, the applicant shall use all reasonable means to conceal or minimize the visual impacts of the WCF's through integration. Integration with existing structures or among other existing uses shall be accomplished through the use of architecture, landscape, and siting solutions. In this case, the panel antennas are proposed to be located within an existing steeple structure, to be enlarged to incorporate larger antennas. Existing and proposed trees and other landscape material will act to improve the appearance of the WCF as seen from the public right-of-way. Based on the design of the facility,

the project complies with the applicable regulations of the Land Development Code, including the allowed deviations being processed with the PDP.

4. The proposed use is appropriate at the proposed location.

WCF's are permitted in residential zones, with a non-residential use where the antennas are located less than 100 feet from the property line of a residential use with the processing of a Conditional Use Permit. Additionally, Council Policy 600-43 encourages that carriers locate WCF in non-residential areas. In this case, AT&T needs to provide coverage in this area, which is surrounded by residential uses. The hilltop Water Department property is primarily used for communication towers— a non-residential use – and is a more preferable area to locate this facility than in the surrounding residentially zoned areas. The faux tree, like the other existing faux trees on site along with the existing and planned landscape will integrate into the existing setting. The WCF is appropriate at this location.

Planned Development Permit - Section 126.0604

1. The proposed development will not adversely affect the applicable land use plan;

The Skyline-Paradise Hills Community Plan does not address wireless communication facilities as a specific land use, however, the City of San Diego's General Plan (UD-15) requires that the visual impact of wireless facilities be minimized by concealing wireless facilities in existing structures or using screening techniques to hide or blend them into the surrounding area. The plan also calls for these facilities to be designed to be aesthetically pleasing and respectful of the neighborhood context. Furthermore, the plan states that equipment associated with wireless facilities be concealed from view. The antennas associated with this wireless facility are proposed to be covered with pine needle socks and mounted on a monopine located on a hilltop above the Skyline Paradise Hills community. The addition of landscape material adjacent to the facility will serve to blend the project into the surroundings. Equipment associated with this facility will be located within a prefabricated enclosure with lattice covered sides to assist with landscape growth on the east side where they may be views from the residential below. The AT&T pine tree will be consistent with the design of the other two 50-foot tall faux pine trees currently on site. Therefore, the proposed development would not adversely affect the Skyline-Paradise Hills Community Plan nor the City of San Diego General Plan and Progress Guide.

2. The proposed development will not be detrimental to the public health, safety, and welfare;

The Telecommunication Act of 1996 preempts local governments from regulating the “placement, construction and modification of wireless communication facilities on the basis of the environmental effects of Radio Frequency (RF) emissions to the extent that such facilities comply with the Federal Communication Commission's (FCC) standards for such emissions.” As noted in the Cumulative RF Report, dated July 14, 2012, the facility will comply with the FCC Guidelines for public safety. Therefore, based on the above, the project would not result in any significant health or safety risks to the surrounding area within the jurisdiction of the City.

- 3. The proposed development will comply with the regulations of the Land Development Code including any proposed deviations pursuant to Section 126.0602(b)(1) that are appropriate for this location and will result in a more desirable project than would be achieved if designed in strict conformance with the development regulations of the applicable zone; and any allowable deviations that are otherwise authorized pursuant to the Land Development Code.**

The RS-1-7 zone allows a maximum height of 30-feet. The faux tree is proposed to be 50-feet tall. The general vicinity is low scale single family homes with the exception of the immediate vicinity, which is the site of a former water tank, but now supports two 50-foot faux pine trees and two communication towers. One of the towers belongs to the City and is used for emergency communications. The other is a 133-foot tall monopole belonging to Verizon. That project was previously denied by Planning Commission and City Council when American Tower Corporation was processing new permits for it. Verizon has taken the project over and will be scheduled for Planning Commission once the environmental document is completed.

If the faux tree were reduced to 30-feet in height, the AT&T coverage foot print would be reduced significantly. As a result, additional facilities would have to be installed throughout the community to compensate for the loss in coverage. Besides being consistent with the other two monopines on site, the location and design of the project and the existing mature and proposed landscaping make this project a well designed wireless communication facility.

BE IT FURTHER RESOLVED that, based on the findings hereinbefore adopted by the Planning Commission, Conditional Use Permit No. 1105583 and Planned Development Permit No. 1105585 is hereby GRANTED by the Planning Commission to the referenced Owner/Permittee, in the form, exhibits, terms and conditions as set forth in Permit No. 1105583 and 1105585, a copy of which is attached hereto and made a part hereof.

Karen Lynch-Ashcraft
Development Project Manager
Development Services

Adopted on: April 25, 2013

Job Order No. 24002669

RECORDING REQUESTED BY
 CITY OF SAN DIEGO
 DEVELOPMENT SERVICES
 PERMIT INTAKE, MAIL STATION 501

WHEN RECORDED MAIL TO

PROJECT MANAGEMENT
PERMIT CLERK
MAIL STATION 501

SPACE ABOVE THIS LINE FOR RECORDER'S USE

INTERNAL ORDER NUMBER: 24002669

CONDITIONAL USE PERMIT NO. 1105583
PLANNED DEVELOPMENT PERMIT NO. 1105585
AT&T – ENCANTO SKYLINE
PROJECT NO. 280764
PLANNING COMMISSION
DRAFT

This Conditional Use Permit No. 1105583 and Planned Development Permit No. 1105585 is granted by the Planning Commission of the City of San Diego to City of San Diego, Owner, and AT&T Mobility, Permittee, pursuant to San Diego Municipal Code [SDMC] section 141.0420 and Chapter 14, Article 3, Division 4. The .563-acre site is located at 6780 Aviation Drive in the RS-1-7 zone of the Skyline – Paradise Hills Community Planning area. The project site is legally described as: That Portion of Lot 162, Encima De San Diego, in the City of San Diego County of San Diego, State of California, according to Map thereof No. 1546, filed in the Office of the County Recorder of San Diego County, March 18, 1913, lying southerly from a line drawn parallel with a distant 60.00feet southerly from the southerly line of Benson Avenue as shown on said Map No. 1546, and easterly from the following described line: Commencing at the point of intersection of the southerly line of said Benson Avenue with the southwesterly line of Aviation Drive, formerly Lot 1, as shown on said Map No. 1546; thence along the southerly line of said Benson Avenue North 89°11' west a distance of 65.00 feet to a point; thence south 0°49' west a distance of 60.00 feet to the true point of commencement; thence continuing south 0°49' west 181 feet, more or less to an intersection with the center line of said Aviation Drive.

Subject to the terms and conditions set forth in this Permit, permission is granted to Permittee for a Wireless Communication Facility described and identified by size, dimension, quantity, type, and location on the approved exhibits [Exhibit "A"] dated April 25, 2013, on file in the Development Services Department.

The project shall include:

- a. A 50-foot tall faux pine tree supporting 12 panel antennas. This is a deviation to the RS-1-7 development regulations for height, which permits a maximum of 30-feet;
- b. A 228-square foot equipment enclosure;
- c. Landscaping (planting, irrigation and landscape related improvements);
- d. Public and private accessory improvements determined by the Development Services Department to be consistent with the land use and development standards for this site in accordance with the adopted community plan, the California Environmental Quality Act [CEQA] and the CEQA Guidelines, the City Engineer's requirements, zoning regulations, conditions of this Permit, and any other applicable regulations of the SDMC.

STANDARD REQUIREMENTS:

1. This permit must be utilized within thirty-six (36) months after the date on which all rights of appeal have expired. If this permit is not utilized in accordance with Chapter 12, Article 6, Division 1 of the SDMC within the 36 month period, this permit shall be void unless an Extension of Time has been granted. Any such Extension of Time must meet all SDMC requirements and applicable guidelines in effect at the time the extension is considered by the appropriate decision maker. This permit must be utilized by May 10, 2016.
2. This Conditional Use Permit (CUP) and corresponding use of this site shall **expire on April 25, 2023**. Upon expiration of this Permit, the facilities and improvements described herein shall be removed from this site and the property shall be restored to its original condition preceding approval of this Permit.
3. No later than ninety (90) days prior to the expiration of this permit, the Permittee may submit a new application to the City Manager for consideration with review and a decision by the appropriate decision maker at that time. Failure to submit prior to the deadline will be cause for enforcement for noncompliance, which may include penalties and fines.
4. Under no circumstances, does approval of this permit authorize AT&T to utilize this site for wireless communication purposes beyond the permit expiration date. Use of this permit beyond the expiration date of this permit is prohibited.
5. No permit for the construction, occupancy, or operation of any facility or improvement described herein shall be granted, nor shall any activity authorized by this Permit be conducted on the premises until:
 - a. The Permittee signs and returns the Permit to the Development Services Department;
and

b. The Permit is recorded in the Office of the San Diego County Recorder.

6. While this Permit is in effect, the subject property shall be used only for the purposes and under the terms and conditions set forth in this Permit unless otherwise authorized by the appropriate City decision maker.

7. This Permit is a covenant running with the subject property and all of the requirements and conditions of this Permit and related documents shall be binding upon the Permittee and any successor(s) in interest.

8. The continued use of this Permit shall be subject to the regulations of this and any other applicable governmental agency.

9. Issuance of this Permit by the City of San Diego does not authorize the Owner/Permittee for this Permit to violate any Federal, State or City laws, ordinances, regulations or policies including, but not limited to, the Endangered Species Act of 1973 [ESA] and any amendments thereto (16 U.S.C. § 1531 et seq.).

10. The Permittee shall secure all necessary building permits. The Permittee is informed that to secure these permits, substantial building modifications and site improvements may be required to comply with applicable building, fire, mechanical, and plumbing codes, and State and Federal disability access laws.

11. Construction plans shall be in substantial conformity to Exhibit "A." Changes, modifications, or alterations to the construction plans are prohibited unless appropriate application(s) or amendment(s) to this Permit have been granted.

12. All of the conditions contained in this Permit have been considered and were determined-necessary to make the findings required for approval of this Permit. The Permit holder is required to comply with each and every condition in order to maintain the entitlements that are granted by this Permit.

13. If any condition of this Permit, on a legal challenge by the Permittee of this Permit, is found or held by a court of competent jurisdiction to be invalid, unenforceable, or unreasonable, this Permit shall be void. However, in such an event, the Permittee shall have the right, by paying applicable processing fees, to bring a request for a new permit without the "invalid" condition(s) back to the discretionary body which approved the Permit for a determination by that body as to whether all of the findings necessary for the issuance of the proposed permit can still be made in the absence of the "invalid" condition(s). Such hearing shall be a hearing de novo, and the discretionary body shall have the absolute right to approve, disapprove, or modify the proposed permit and the condition(s) contained therein.

14. The Permittee shall defend, indemnify, and hold harmless the City, its agents, officers, and employees from any and all claims, actions, proceedings, damages, judgments, or costs, including attorney's fees, against the City or its agents, officers, or employees, relating to the issuance of this permit including, but not limited to, any action to attack, set aside, void, challenge, or annul this

development approval and any environmental document or decision. The City will promptly notify Permittee of any claim, action, or proceeding and, if the City should fail to cooperate fully in the defense, the Permittee shall not thereafter be responsible to defend, indemnify, and hold harmless the City or its agents, officers, and employees. The City may elect to conduct its own defense, participate in its own defense, or obtain independent legal counsel in defense of any claim related to this indemnification. In the event of such election, Permittee shall pay all of the costs related thereto, including without limitation reasonable attorney's fees and costs. In the event of a disagreement between the City and Permittee regarding litigation issues, the City shall have the authority to control the litigation and make litigation related decisions, including, but not limited to, settlement or other disposition of the matter. However, the Permittee shall not be required to pay or perform any settlement unless such settlement is approved by Permittee.

ENGINEERING REQUIREMENTS:

15. The project proposes to export 13 cubic yards of material from the project site. All excavated material listed to be exported, shall be exported to a legal disposal site in accordance with the Standard Specifications for Public Works Construction (the "Green Book"), 2003 edition and Regional Supplement Amendments adopted by Regional Standards Committee.
16. Prior to the issuance of any construction permit, the Permittee shall enter into a Maintenance Agreement for the ongoing permanent BMP maintenance, satisfactory to the City Engineer.
17. Prior to the issuance of any construction permit, the Permittee shall incorporate any construction Best Management Practices necessary to comply with Chapter 14, Article 2, Division 1 (Grading Regulations) of the San Diego Municipal Code, into the construction plans or specifications.
18. Prior to the issuance of any construction permit the Permittee shall submit a Water Pollution Control Plan (WPCP). The WPCP shall be prepared in accordance with the guidelines in Appendix E of the City's Storm Water Standards.

LANDSCAPE REQUIREMENTS:

19. Prior to construction permit issuance, landscape plans in substantial conformance with this Development Permit shall be submitted for approval.
20. All required landscape shall be maintained in a disease, weed and litter free condition at all times.
21. If any landscape, including plantings, hardscape or irrigation, is damaged or removed during construction, it shall be repaired and/or replaced in kind per the approved plans to the satisfaction of the Development Services Department.

PLANNING/DESIGN REQUIREMENTS:

22. A topographical survey conforming to the provisions of the SDMC may be required if it is determined, during construction, that there may be a conflict between the building(s) under construction and a condition of this Permit or a regulation of the underlying zone. The cost of any such survey shall be borne by the Permittee.
23. All proposed hand-holes shall be covered with bark material to match the tree trunk to the satisfaction of the Development Services Department.
24. All coaxial conduits shall be routed up through the caisson and into the tree to the satisfaction of the Development Services Department. Cable enclosures (referred to as “doghouses”) are not permitted.
25. Branches shall extend a minimum of 24-inches beyond the face of the proposed antennas to the satisfaction of the Development Services Department.
26. Starting branch height shall be no lower than 10-feet, as illustrated on the stamped, approved Exhibit “A.”
27. All exposed cables, brackets and supports shall be painted to match the faux tree foliage to the satisfaction of the Development Services Department.
28. Radio-frequency transparent “socks” fully covering the front and back of the antennas (and any other components) shall be installed.
29. The applicant is required to provide color samples of the faux tree prior to Building Permit issuance. This is to ensure that the proposed faux tree integrates with the surrounding landscape. Staff will pre-approve the color sample prior to Building Permit issuance. The exact faux tree color exhibit will be used during the FINAL INSPECTION. The color approved by Planning Staff must be identical to the as-built faux tree.
30. Faux trees rely on existing and/or proposed trees to integrate with the surroundings. Additional trees may be required, to effectively integrate the faux tree, to the satisfaction of the Development Services Department.
31. All private outdoor lighting shall be shaded and adjusted to fall on the same premises where such lights are located and in accordance with the applicable regulations in the SDMC.
32. All facilities and related equipment shall be: maintained in good working order; free from trash, debris, graffiti; and designed to discourage vandalism. Any damaged equipment shall be repaired or replaced within thirty (30) calendar days of notification by the City of San Diego.
33. The Permittee shall notify the City within 30 days of the sale or transfer of this site to any other provider or if the site is no longer operational requiring the removal and the restoration of this site to its original condition.

34. The photosimulation(s) for the proposed project shall be printed (not stapled) on the building plans. This is to ensure the construction team building the project is in compliance with approved the Exhibit "A."
35. Exposed mounting apparatus shall be removed and shall not remain on the faux tree absent antennas.
36. The Permittee shall not cause or allow the antennas to be different sizes (length, width, or height) than as shown on the stamped approved plans.
37. The WCF shall conform to Exhibit "A" (consisting of the stamped approved plans and approved photosimulations) prior to receiving final inspection approval.
38. All equipment, including transformers, emergency generators and air conditioners belonging to the Permittee shall be designed and operated consistent with the City noise ordinance. Ventilation openings shall be baffled and directed away from residential areas. Vibration resonance of operating equipment in the equipment enclosures shall be eliminated.
39. The Permittee shall place appropriate signage on the WCF as required by CAL-OSHA/FCC to the satisfaction of the Development Services Department.

APPROVED by the Planning Commission of the City of San Diego on April 25, 2013 by Resolution Number XXXXXXXX.

INFORMATION ONLY:

- The issuance of this discretionary use permit alone does not allow the immediate commencement or continued operation of the proposed use on site. The operation allowed by this discretionary use permit may only begin or recommence after all conditions listed on this permit are fully completed and all required ministerial permits have been issued and received final inspection.
- A "Telecom Planning Inspection" will be required prior to Final Clearance from the City's Building Inspector to ensure compliance with the approved plans, exhibits, and associated conditions. Prior to calling for your Final Inspection from your building inspection official, please contact the Project Manager listed below at **(619) 446-5351** to schedule an inspection of the completed WCF. Please request the telecom inspection at least five working days ahead of the requested Final inspection.
- Any party on whom fees, dedications, reservations, or other exactions have been imposed as conditions of approval of this Permit, may protest the imposition within ninety days of the approval of this development permit by filing a written protest with the City Clerk pursuant to California Government Code-section 66020.
- This development may be subject to impact fees at the time of construction permit issuance.

Permit Type/PTS Approval No.: CUP No. 1105583/PDP No. 1105585
Date of Approval: April 25, 2013

AUTHENTICATED BY THE CITY OF SAN DIEGO DEVELOPMENT SERVICES
DEPARTMENT

Karen Lynch-Ashcraft
Development Project Manager

**NOTE: Notary acknowledgment
must be attached per Civil Code
section 1189 et seq.**

The undersigned Owner/Permittee, by execution hereof, agrees to each and every condition of this Permit and promises to perform each and every obligation of Owner/Permittee hereunder.

AT&T Mobility
Permittee

By _____
Kevin Becker
Senior Real Estate Construction Manager

City of San Diego
Owner

By _____
David A. Sandoval, CCIM
Deputy Director, Real Estate Assets

**NOTE: Notary acknowledgments
must be attached per Civil Code
section 1189 et seq.**

EXISTING COVERAGE *WITHOUT* PROPOSED AT&T FACILITY (SD0563)

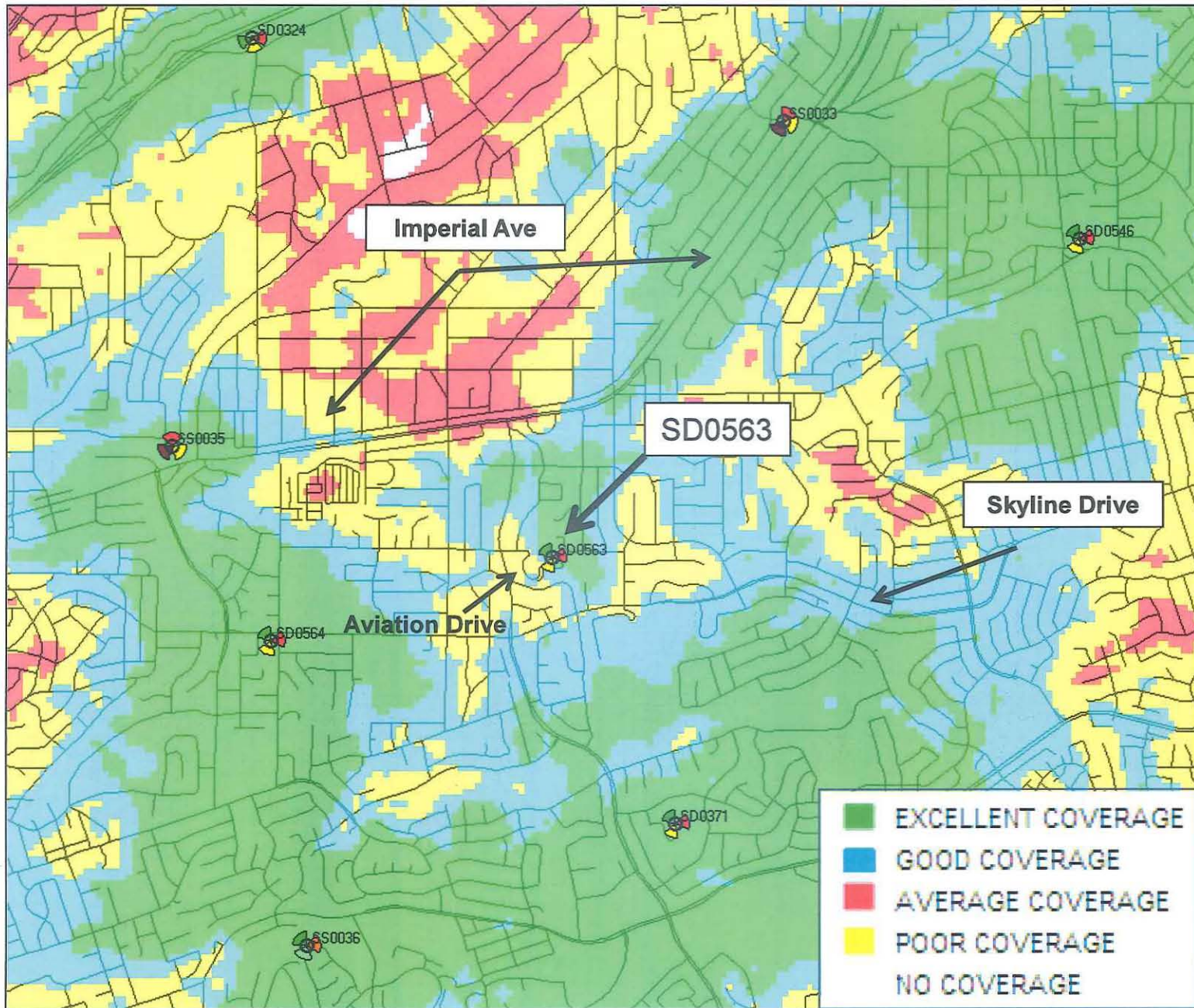

EXISTING COVERAGE WITH PROPOSED AT&T FACILITY (SD0563)

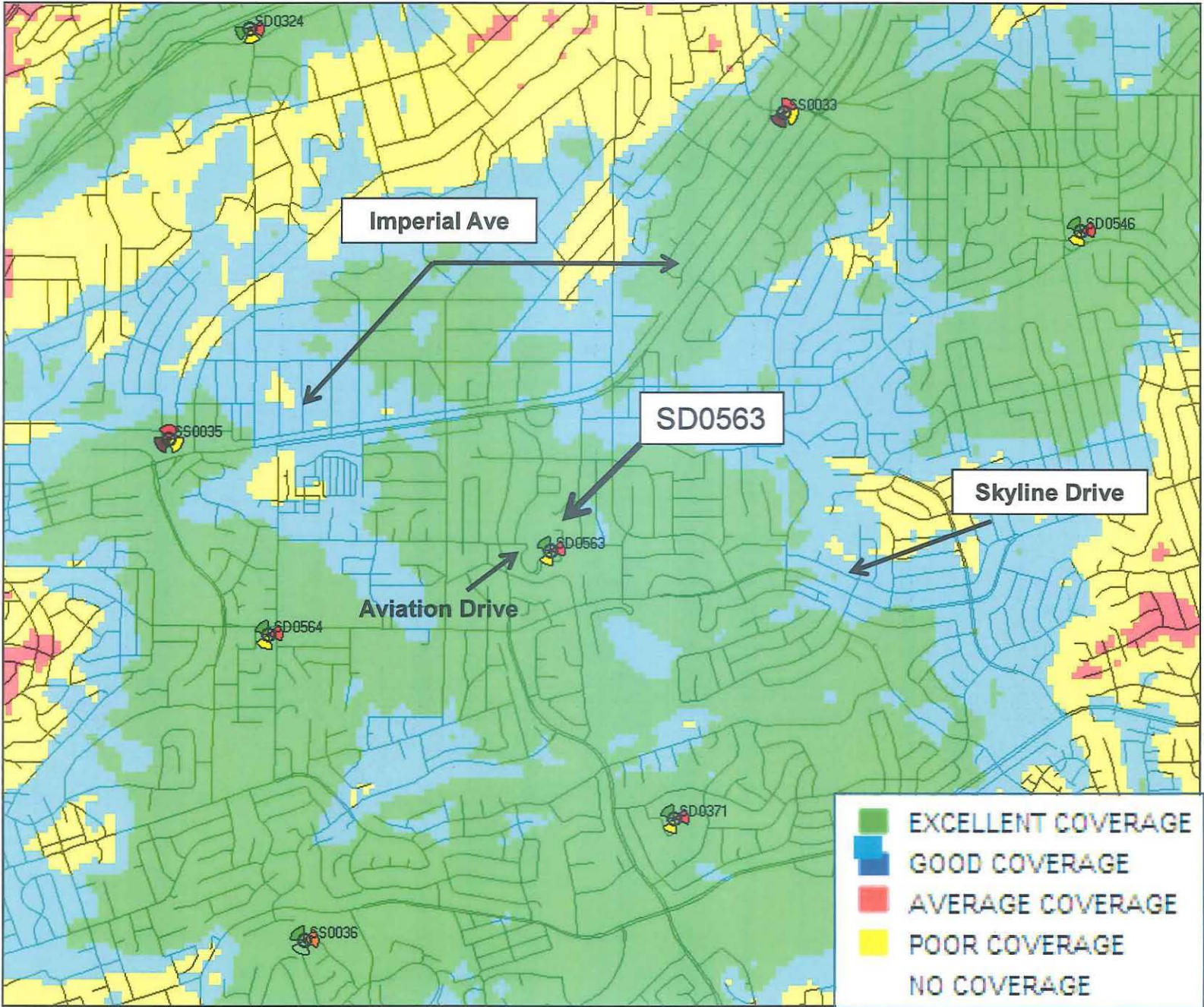



SD0563
ENCANTO SANDPIPE (SKYLINE)
6780 AVIATION DRIVE
SAN DIEGO, CA 92114

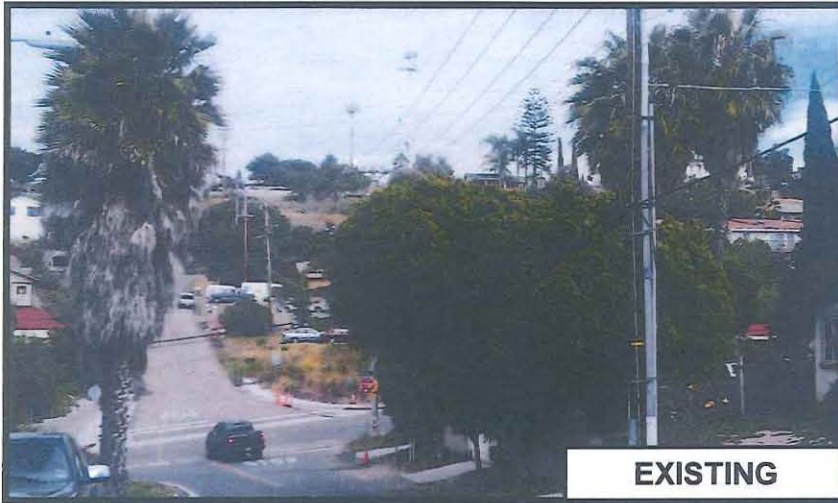

EXISTING

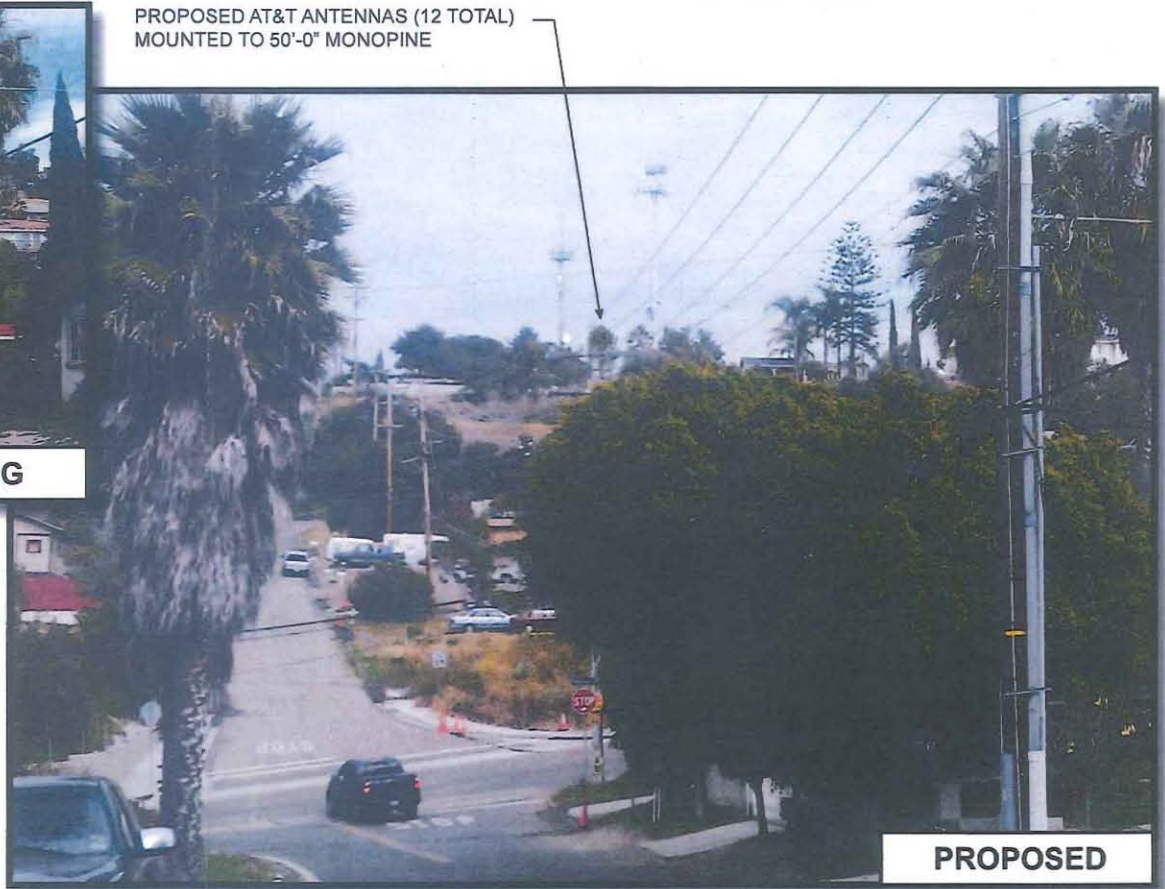

PROPOSED

PROPOSED AT&T ANTENNAS (12 TOTAL)
MOUNTED TO 50'-0" MONOPINE

1

ATTACHMENT 8

VIEWPOINT 1



SD0563
ENCANTO SANDPIPE (SKYLINE)
 6780 AVIATION DRIVE
 SAN DIEGO, CA 92114



PROPOSED AT&T ANTENNAS (12 TOTAL)
 MOUNTED TO 50'-0" MONOPINE

2

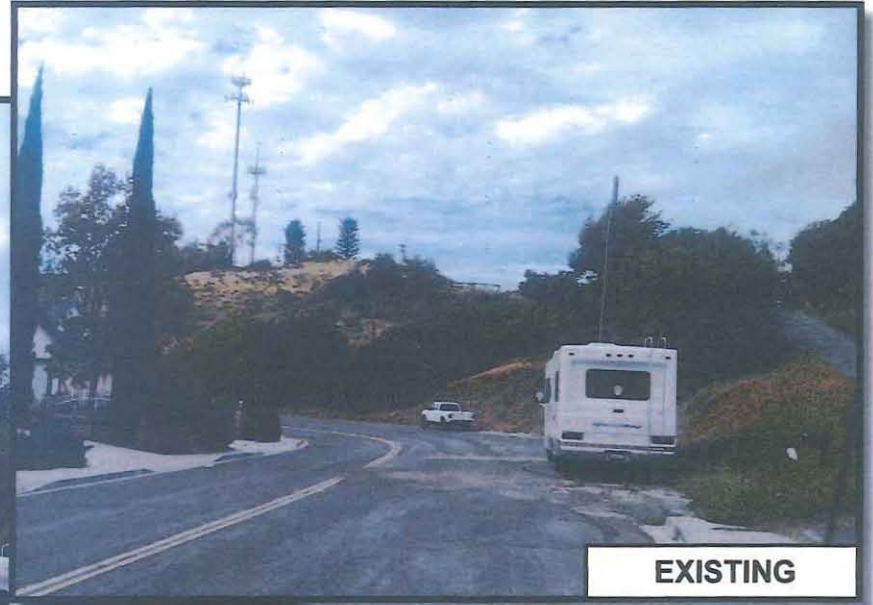
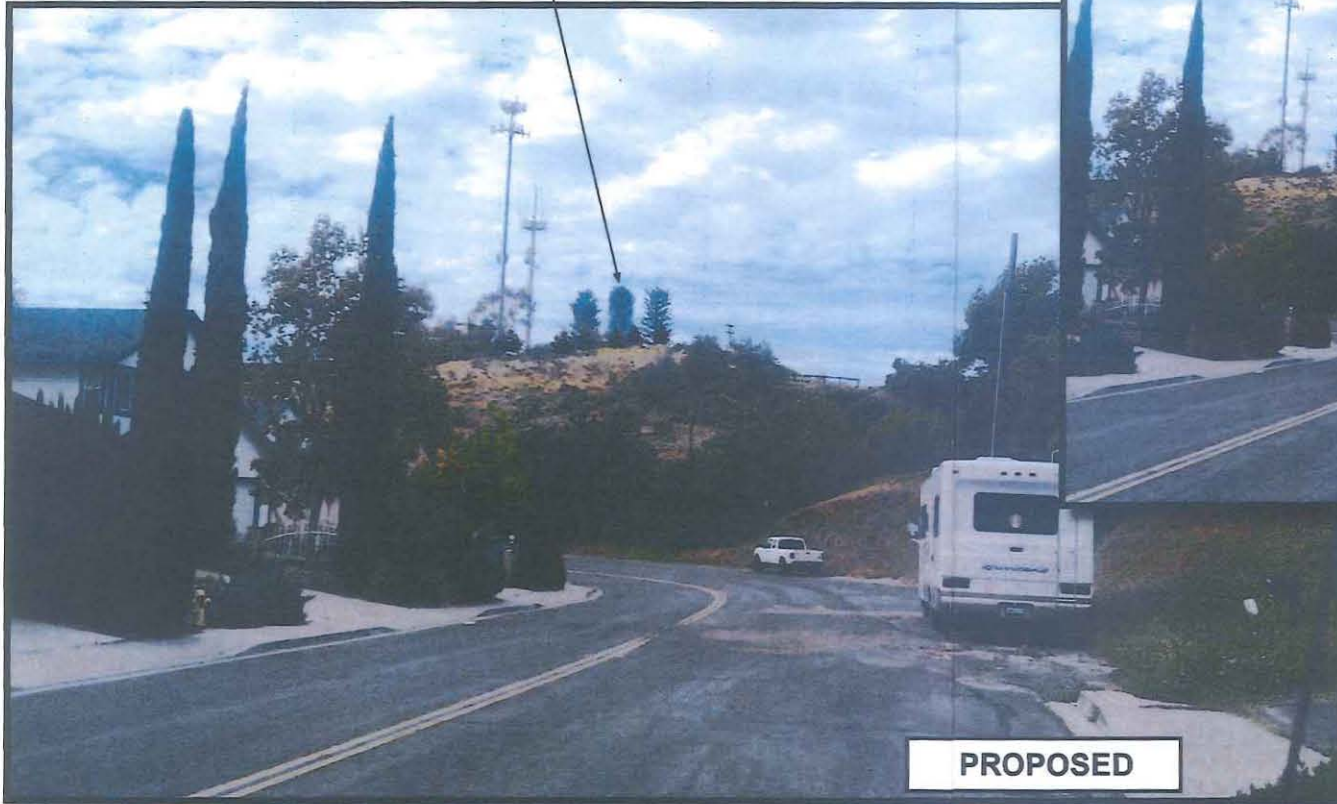

*NOTE: LANDSCAPING SHOWN AT MATURITY.

ATTACHMENT 8

VIEWPOINT 2

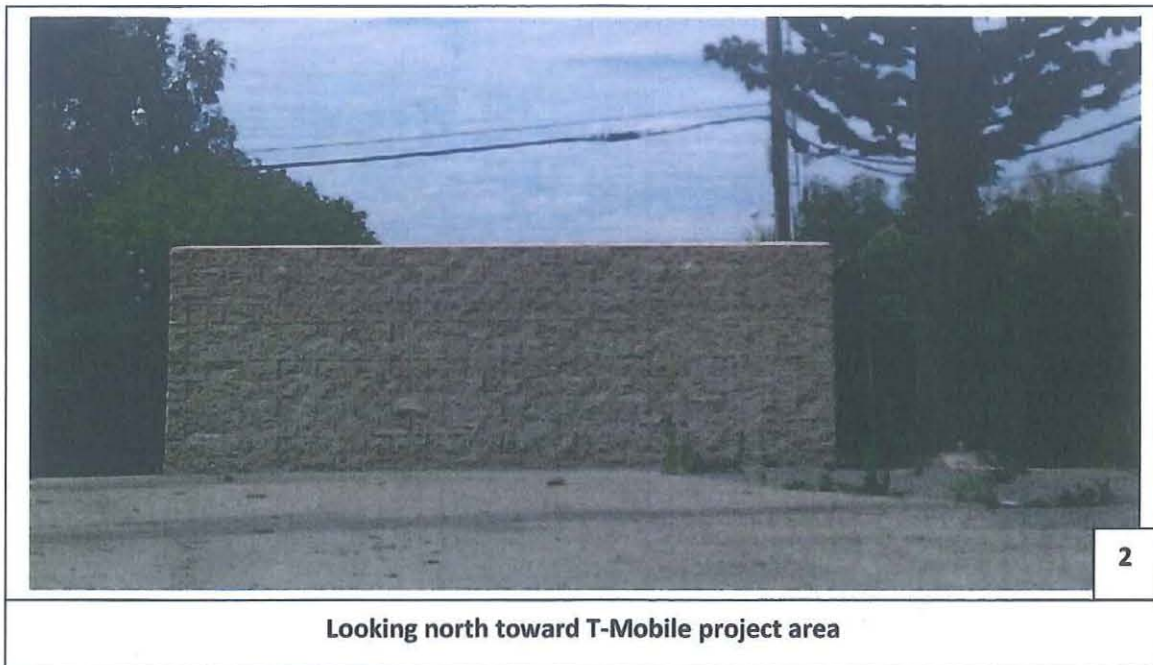
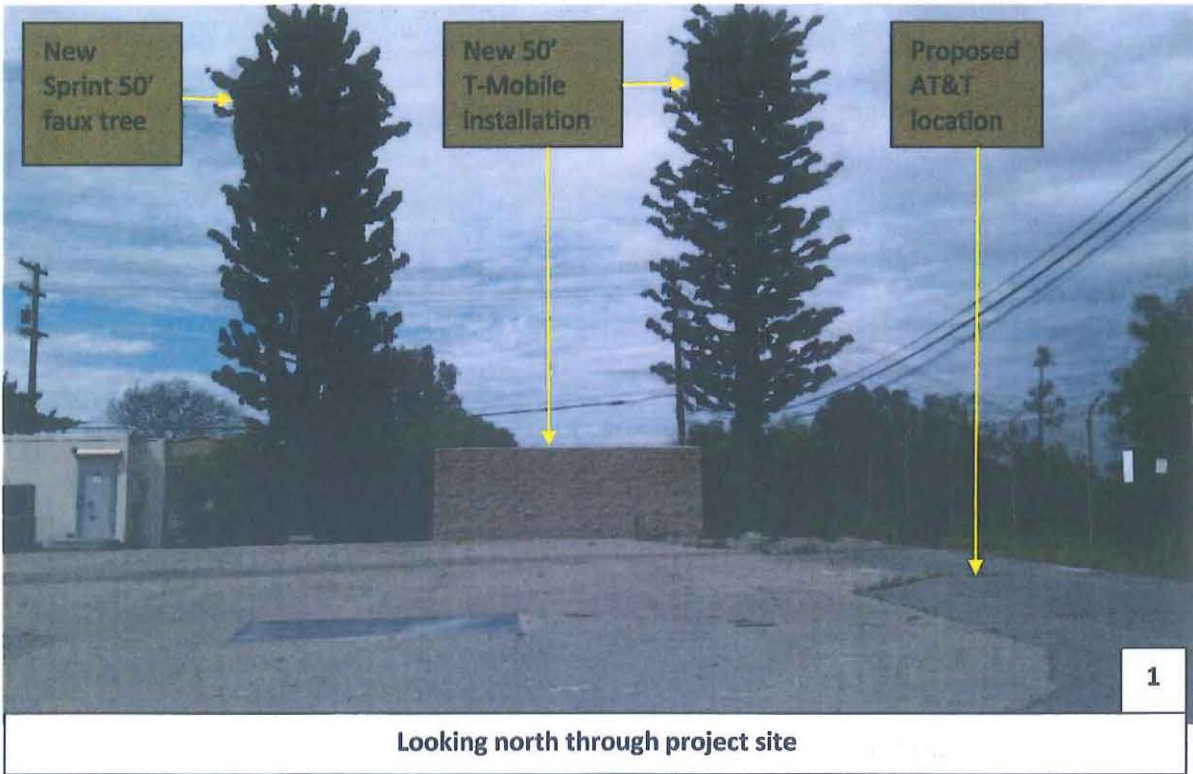



3

Looking SE towards AT&T project site



4

Looking westerly at existing monopoles and new faux trees
(Sprint/Nextel, Verizon, City of San Diego)



5

Looking north from the project site

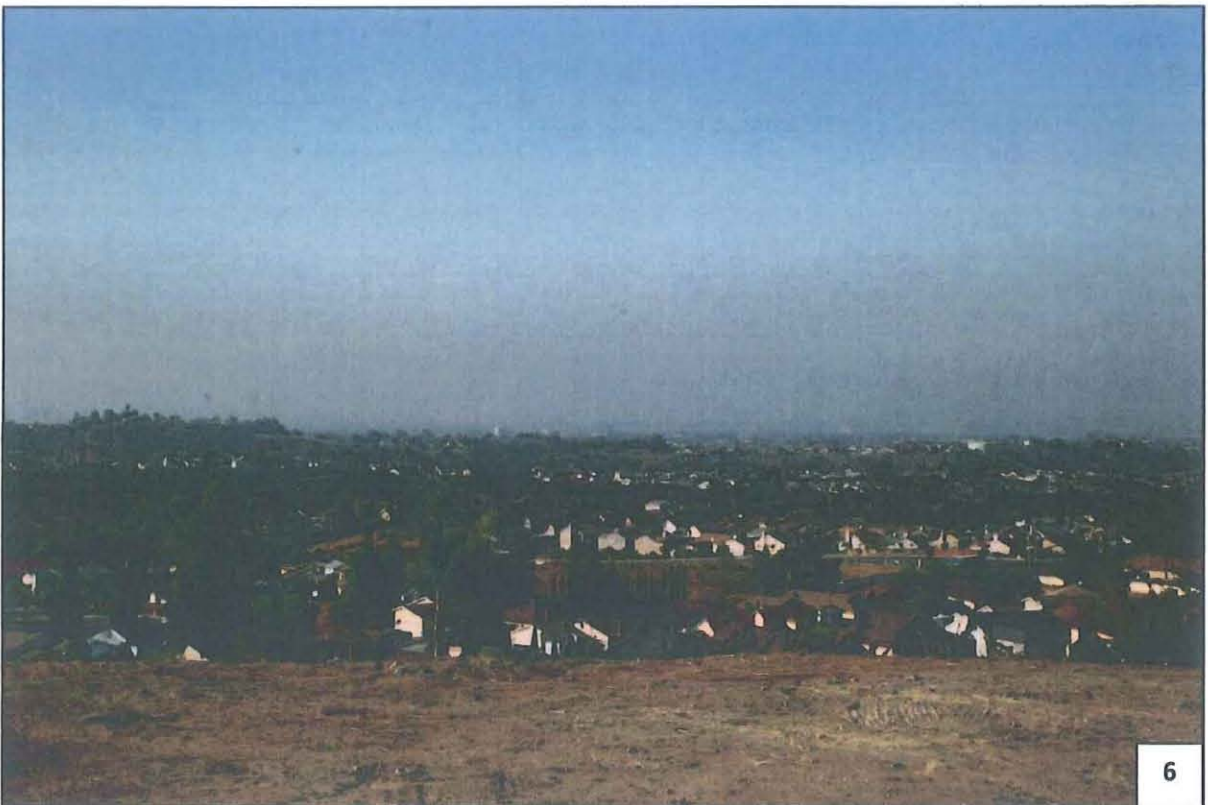

6

Looking south from the project site



7

Looking east from the project site

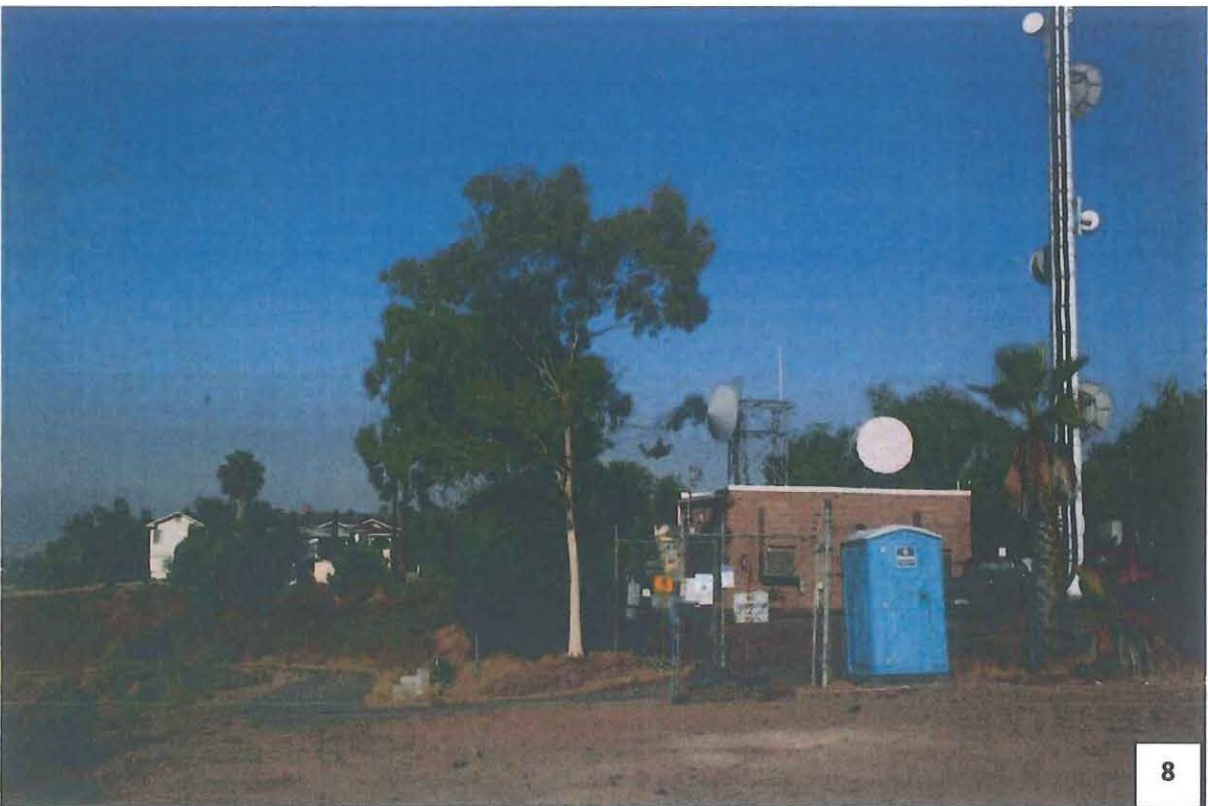

8

Looking west from the project site towards the access road

NOTICE OF EXEMPTION

ATTACHMENT 10

(Check one or both)

TO: X RECORDER/COUNTY CLERK
P.O. BOX 1750, MS A-33
1600 PACIFIC HWY, ROOM 260
SAN DIEGO, CA 92101-2422

FROM: CITY OF SAN DIEGO
DEVELOPMENT SERVICES DEPARTMENT
1222 FIRST AVENUE, MS 501
SAN DIEGO, CA 92101

 OFFICE OF PLANNING AND RESEARCH
1400 TENTH STREET, ROOM 121
SACRAMENTO, CA 95814

PTS No.: 280764

PROJECT TITLE: AT&T Encanto-Skyline

PROJECT LOCATION-SPECIFIC: The project is located at 6780 Aviation Drive, San Diego, California 92114 within the Skyline-Paradise Hills Community Plan area.

PROJECT LOCATION-CITY/COUNTY: San Diego/San Diego

DESCRIPTION OF NATURE AND PURPOSE OF THE PROJECT: The project is a Conditional Use Permit (CUP)/Planned Development Permit (PDP) for a Wireless Communication Facility (WCF) consisting of a 50 feet tall monopole supporting 12 panel antennas and a 228 square-foot equipment enclosure on a 0.08 acre site.

NAME OF PUBLIC AGENCY APPROVING PROJECT: City of San Diego

NAME OF PERSON OR AGENCY CARRYING OUT PROJECT: Kevin Becker
AT&T Mobility NSB Program - San Diego
7337 Trade Street, 3East, Room 3684
San Diego, CA 92121-4202
858-717-7908

EXEMPT STATUS: (CHECK ONE)

- MINISTERIAL (SEC. 21080(b)(1); 15268);
- DECLARED EMERGENCY (SEC. 21080(b)(3); 15269(a));
- EMERGENCY PROJECT (SEC. 21080(b)(4); 15269 (b)(c))
- CATEGORICAL EXEMPTION: 15303 (New Construction or Conversion of Small Structures)
- STATUTORY EXEMPTIONS:

REASONS WHY PROJECT IS EXEMPT: The City of San Diego conducted an environmental review which determined that this project, the installation of a WCF consisting of a 50 feet tall monopole supporting 12 panel antennas and a 228 square – feet equipment enclosure, meets the criteria set forth in CEQA Section 15303, which allows for minor alteration of facilities involving no or a negligible expansion of use, and construction and location of limited numbers of new small facilities or structures, respectively. The exceptions listed in CEQA Section 15300.2 would not apply.

LEAD AGENCY CONTACT PERSON: Anna L. McPherson

TELEPHONE: 619-446-5276

IF FILED BY APPLICANT:

1. ATTACH CERTIFIED DOCUMENT OF EXEMPTION FINDING.
2. HAS A NOTICE OF EXEMPTION BEEN FILED BY THE PUBLIC AGENCY APPROVING THE PROJECT?
 Yes No

IT IS HEREBY CERTIFIED THAT THE CITY OF SAN DIEGO HAS DETERMINED THE ABOVE ACTIVITY TO BE EXEMPT FROM CEQA

Anna L. McPherson AICP / Senior Planner

SIGNATURE/TITLE

MARCH 8, 2013

DATE

CHECK ONE:

SIGNED BY LEAD AGENCY

DATE RECEIVED FOR FILING WITH COUNTY CLERK OR OPR:



Minutes of June 12, 2012

Attendees

Wayne English-Treasurer Guy Preuss
William Glover Michelle Krug
William Penick – Chair Senta Delgado
Nathan Beltz John Mooney – Secretary

Absent

Yolanda Lujan
Richard Lujan
James Keitt
Cathy Ramsey - Vice-
Chair
Yvonne Hunt

6:30 p.m. **Correspondence review**

7:00 p.m. **Call to order & Approval of Agenda** N. Beltz moved to accept agenda, 2nd – S. Delgado; approved, 7-0.

7:02p.m. **Announcements & Public Comment**

7:03 p.m. **Approval of April Meeting Minutes** Motion to approve April, 2012 minutes as corrected by G. Pruess, 2nd - W. English; approved 6-0 with J. Mooney abstaining.

7:05 p.m. **Treasurer's Report:** \$331.01 on account in the bank.

7:22 p.m. **Presentations**

1. Officer Mercado reviewed community crime statistics and announced that the annual National Night Out will be held August 7 at the Skyview Park.
<http://www.nationaltownwatch.org/nno/>. Officer Mercado can be contacted at jmercado@pd.sandiego.gov.
2. Bruce Williams, for Councilman Anthony Young, discussed recent and planned activities of the Councilman. The most recent Community Update letter is available at <http://www.sandiego.gov/citycouncil/cd4/updates/index.shtml>.
3. The City Community Planning Committee (CPC) representative summarized the most recent meeting. More information is available at <http://sandiego.gov/cpci>.

7:20 p.m. **Informational items** - none.

8:00 p.m. **Action items** – G. Preuss moved to approve project #280764 internal order #24002669 located at 6780 Aviation Drive, as presented by Monica Moretta, on behalf of AT&T, to replace

a currently standing cellular phone tower with a 50 ft. faux pine tree tower; second by W. Glover; approved 7-0.

8:30 p.m. Motion to Adjourn by W. Glover, 2nd – W. English; approved 7-0.

Minutes submitted by John Mooney.

Project Chronology
AT&T – Encanto Skyline
PTS No. 280764

Date	Action	Description	City Review Time	Applicant Response
5/16/12	Submittal for Completeness Check			
5/21/12	Completeness Review Assessment		5 days	
7/24/12	First Full Submittal	Deemed Complete		2 months, 3 days
9/5/12	First Assessment		1 month, 12 days	
1/28/13	Second Submittal			4 months, 23 days
2/22/13	Second Assessment		25 days	
3/8/13	Notice of Exemption		14 days	
3/8/13	Issues Resolved			
4/24/13	Planning Commission Hearing		1 month , 17 days	
TOTAL STAFF TIME**			4 months 13 days	
TOTAL APPLICANT TIME**				6 months, 26 days
TOTAL PROJECT RUNNING TIME**			11 months, 19 days	

**Based on 30 days equals to one month.



SD0563 ENCANTO STANDPIPE (SKYLINE)

6780 AVIATION DRIVE
SAN DIEGO, CA 92114

ARCHITECT



DI DONATO ASSOCIATES
ARCHITECTURE + GRAPHICS
3809 FIRST AVENUE, SUITE 100, SAN DIEGO, CA 92103
619.299.4210 • 619.299.4255 FAX • DDONATO@DAA.COM

PROJECT NAME



SD0563
ENCANTO STANDPIPE (SKYLINE)
6780 AVIATION DRIVE, SAN DIEGO, CA 92114

ISSUES REVISIONS

DATE	BY	ISSUE DESCRIPTION
11-23-10	BKH	BOX FOR REVIEW
11-30-10	BKH	REV 0 FOR SUBMITTAL
03-10-11	BKH	REV 1 PER CITY COMMENTS
04-16-11	BKH	REV 2 PER COUNTY
05-10-11	BKH	REV 3 PER CS&E
05-10-11	BKH	REV 4 PER CS&E
06-18-12	JLZ	REV 5 REVISED PER CITY COMMENTS
10-30-12	TJW	REV 6 PER CITY COMMENTS
01-21-13	RHA	REV 7 ANTENNAS CHANGED TO 6" TYPE

SHEET INFORMATION

DI DONATO ASSOCIATES
ARCHITECTURE + GRAPHICS
T01
TITLE SHEET

SD0563
1003.24
PLOT SCALE 1 : 1 (24x36" D SIZE)

DRIVING DIRECTIONS FROM AT&T OFFICE:

- TAKE I-805 SOUTH
- TAKE EXIT 12A FOR IMPERIAL AVENUE
- TURN LEFT AT IMPERIAL AVENUE
- TURN RIGHT AT WOODMAN STREET
- TURN LEFT AT BENSON AVENUE
- BENSON AVENUE TURNS RIGHT AND BECOMES AVIATION DRIVE

PROJECT APPLICANT:
AT&T MOBILITY
7337 TRADE ST.
SEAST, ROOM 3684
SAN DIEGO, CA 92121-4202

PROPERTY OWNER:
CITY OF SAN DIEGO
SAN DIEGO, CA
SITE CONTACT: CAROL YOUNG

CONSTRUCTION MANAGER:
KEVIN BURGESS
BLACK AND VEATCH
9820 WILLOW CREEK ROAD,
SUITE 310
SAN DIEGO, CA 92131
619-306-3541

ARCHITECT:
DI DONATO ASSOCIATES
3939 FIRST AVE, SUITE 100
SAN DIEGO, CA 92103
619.299.4210 PHONE
619.299.4250 FAX
ddamail@aol.com

PLANNING REPRESENTATIVE:
JIM KENNEDY
TMC
5473 KEARNY VILLA RD.
SUITE 300
SAN DIEGO, CA 92123
619-341-3396

SITE ACQUISITION:
JEFF GOLDMAN
TMC
9089 CLAIREMONT MESA BLVD.
SUITE 200
SAN DIEGO, CA 92123
619-806-0858

R.F. ENGINEERING REPRESENTATIVE:
FRAN JUNGAL
5738 PACIFIC CENTER BLVD.
SAN DIEGO, CA 92121
619-699-9254

PROJECT DESCRIPTION:

THE PROJECT CONSISTS OF THE INSTALLATION AND OPERATION OF (12) TWELVE ANTENNAS AND ASSOCIATED EQUIPMENT CABINETS FOR AT&T TELECOMMUNICATIONS NETWORK.

A TOTAL OF (12) TWELVE ANTENNAS ARE TO BE MOUNTED ON A NEW 50' HIGH MONOPINE. EQUIPMENT CABINETS ARE TO BE LOCATED INSIDE A NEW 11'-5"x20'-0" PREFABRICATED EQUIPMENT SHELTER.

THE FACILITY WILL ENHANCE THE GENERAL HEALTH, SAFETY, AND WELFARE OF THE COUNTY AND SURROUNDING CITIES BY PROVIDING MORE RELIABLE CELLULAR COMMUNICATION AT THIS LOCATION. PREVIOUSLY APPROVED EQUIPMENT TO REMAIN AS IS.

NOTE: EXISTING CARRIERS: NEXTEL/SPRINT, T-MOBILE, VERIZON

SITE ADDRESS:
6780 AVIATION DRIVE
SAN DIEGO, CA 92114

JURISDICTION:
CITY OF SAN DIEGO

ASSESSOR'S PARCEL NUMBER:
549-320-05-00

CURRENT USE:
TELECOMMUNICATIONS

LATITUDE:
32°42'16.50" N

EXISTING OCCUPANCY:
N/A

LONGITUDE:
117°03'08.29" W

PROPOSED OCCUPANCY:
S-2 AT EQUIPMENT ENCLOSURE

TOTAL SITE AREA:
22,276.6 SF (.51 ACRE)

SETBACKS:
FRONT: 15'
SIDE: .08 x LOT WIDTH
STREET SIDE: .10 x LOT WIDTH
REAR: 13'

EXISTING FLOOR AREA:
N/A

HEIGHT LIMIT:
30 FEET

PROPOSED PROJECT AREA:
APPROX. 400 SF

WATER/SEWAGE:
N/A

EXISTING TYPE OF CONSTRUCTION:
N/A

UTILITIES:

PROPOSED TYPE OF CONSTRUCTION:
TYPE V-N

ELECTRICAL: SD&E

TELEPHONE: AT&T

EXISTING ZONING:
RS-1-7

FIRE DEPT.: CITY OF SAN DIEGO

ALL WORK SHALL COMPLY WITH THE FOLLOW APPLICABLE CODES:

- CALIFORNIA BUILDING CODE, 2010 EDITION (BASED ON 2009 IBC)
- CALIFORNIA PLUMBING CODE, 2010 EDITION (BASED ON 2008 UPC BY IAPMO)
- CALIFORNIA MECHANICAL CODE, 2010 EDITION (BASED ON 2008 UMC BY IAPMO)
- CALIFORNIA ELECTRICAL CODE, 2010 EDITION (BASED ON 2007 NEC)
- CALIFORNIA FIRE CODE, 2010 EDITION (BASED ON 2008 IFC)
- CALIFORNIA GREEN BUILDING CODE, 2010 EDITION

NOTE: THE WIRELESS COMMUNICATIONS FACILITY COMPLIES WITH FEDERAL STANDARDS FOR RADIO FREQUENCY IN ACCORDANCE WITH THE TELECOMMUNICATIONS ACT OF 1996 AND SUBSEQUENT AMENDMENTS AND ANY OTHER REQUIREMENTS IMPOSED BY STATE OR FEDERAL REGULATORY AGENCIES.

PROJECT INFORMATION

FACILITY IS UNMANNED AND NOT FOR HUMAN HABITATION. WIRELESS TELECOMMUNICATIONS MECHANICAL EQUIPMENT ROOMS ARE EXEMPT FROM REQUIREMENTS TO PROVIDE BUILDING UPGRADES FOR DISABLED ACCESS PER THE FOLLOWING:

CBC SECTION 1105B-BUILDING ACCESSIBILITY
CAL ACS ACCESSIBILITY STANDARDS INTERPRETIVE MANUAL

ADA COMPLIANCE

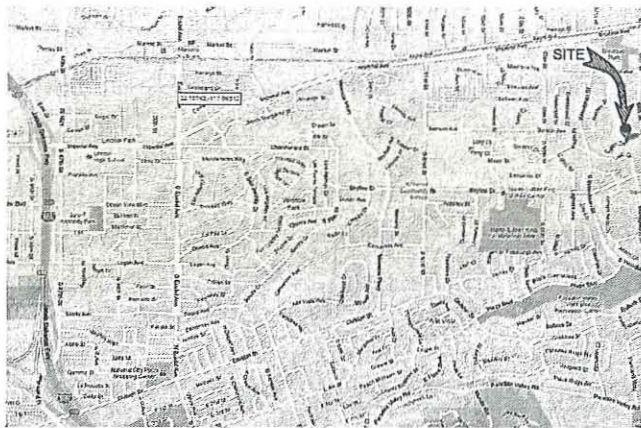

THOMAS GUIDE MAP #1290-E4

© GOOGLE 2010

VICINITY MAP

THAT PORTION OF LOT 162, ENCLAVA DE SAN DIEGO, IN THE CITY OF SAN DIEGO, COUNTY OF SAN DIEGO, STATE OF CALIFORNIA, ACCORDING TO MAP THEREOF NO. 1548, FILED IN THE OFFICE OF THE COUNTY RECORDER OF SAN DIEGO COUNTY, MARCH 16, 1913, LYING SOUTHERLY FROM A LINE DRAWN PARALLEL WITH A DISTANT 60.00 FEET SOUTHERLY FROM THE SOUTHERLY LINE OF BENSON AVENUE, FORMERLY BOSTON AVENUE AS SHOWN ON SAID MAP NO. 1548, AND EASTERLY FROM THE FOLLOWING DESCRIBED LINE:

COMMENCING AT THE POINT OF INTERSECTION OF THE SOUTHERLY LINE OF SAID BENSON AVENUE WITH THE SOUTHWESTERLY LINE OF AVIATION DRIVE, FORMERLY LOT 1, AS SHOWN ON SAID MAP NO. 1548; THENCE ALONG THE SOUTHERLY LINE OF SAID BENSON AVENUE NORTH 89°11' WEST A DISTANCE OF 65.00 FEET TO A POINT; THENCE SOUTH 0°49' WEST A DISTANCE OF 60.00 FEET TO THE TRUE POINT OF COMMENCEMENT; THENCE CONTINUING SOUTH 0°49' WEST 181 FEET, MORE OR LESS, TO AN INTERSECTION WITH THE CENTER LINE OF SAID AVIATION DRIVE.

LEGAL DESCRIPTION

CONTACTS

#	TYPE OF INSPECTION	DESIGN STRENGTH
	SEE SHEET S01 FOR SPECIAL INSPECTIONS	

NOT USED

T01 TITLE SHEET

- Z01 SITE PLAN
- Z02 AREA PLAN
- Z03 ELEVATIONS
- Z04 ELEVATIONS
- Z05 ANTENNA DETAILS
- Z06 SHELTER ELEVATIONS
- Z07 EQUIPMENT PLAN

L01 LANDSCAPE DEVELOPMENT PLAN

- POLE DRAWINGS:**
- S1 POLE ELEVATION, NOTES
 - S2 DETAILS

- C01 SURVEY
- C02 SURVEY

SHEET INDEX

CONSTRUCTION REPRESENTATIVE	
SITE ACQUISITION	
R.F. ENGINEERING REPRESENTATIVE	
PLANNING REPRESENTATIVE	
AT&T REPRESENTATIVE	
LANDLORD	

APPROVALS

1

2

3

4

5

6

7

8

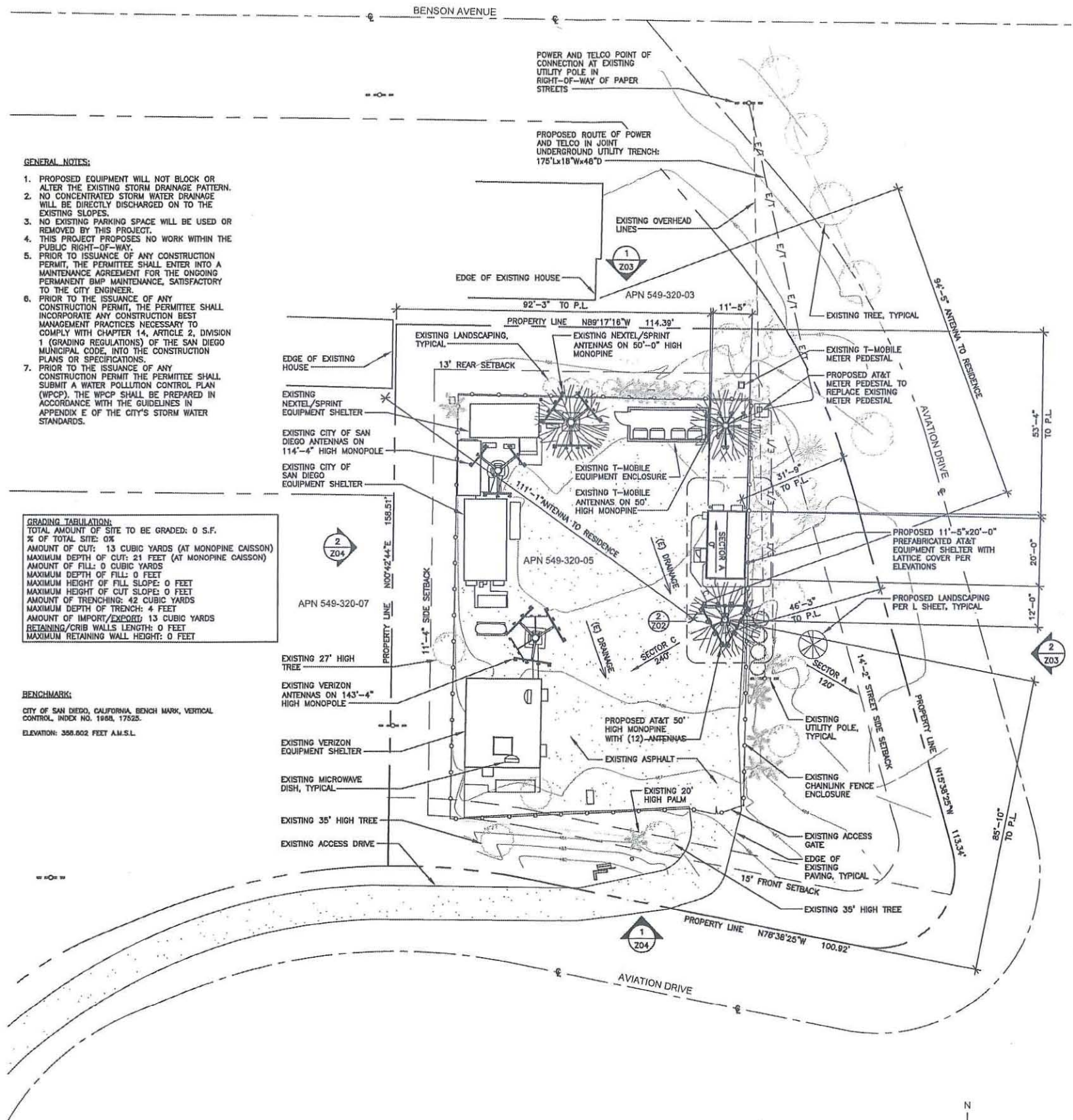

- GENERAL NOTES:**
1. PROPOSED EQUIPMENT WILL NOT BLOCK OR ALTER THE EXISTING STORM DRAINAGE PATTERN.
 2. NO CONCENTRATED STORM WATER DRAINAGE WILL BE DIRECTLY DISCHARGED ON TO THE EXISTING SLOPES.
 3. NO EXISTING PARKING SPACE WILL BE USED OR REMOVED BY THIS PROJECT.
 4. THIS PROJECT PROPOSES NO WORK WITHIN THE PUBLIC RIGHT-OF-WAY.
 5. PRIOR TO ISSUANCE OF ANY CONSTRUCTION PERMIT, THE PERMITEE SHALL ENTER INTO A MAINTENANCE AGREEMENT FOR THE ONGOING PERMANENT BMP MAINTENANCE, SATISFACTORY TO THE CITY ENGINEER.
 6. PRIOR TO THE ISSUANCE OF ANY CONSTRUCTION PERMIT, THE PERMITEE SHALL INCORPORATE ANY CONSTRUCTION BEST MANAGEMENT PRACTICES NECESSARY TO COMPLY WITH CHAPTER 14, ARTICLE 2, DIVISION 1 (GRADING REGULATIONS) OF THE SAN DIEGO MUNICIPAL CODE, INTO THE CONSTRUCTION PLANS OR SPECIFICATIONS.
 7. PRIOR TO THE ISSUANCE OF ANY CONSTRUCTION PERMIT THE PERMITEE SHALL SUBMIT A WATER POLLUTION CONTROL PLAN (WPCP). THE WPCP SHALL BE PREPARED IN ACCORDANCE WITH THE GUIDELINES IN APPENDIX E OF THE CITY'S STORM WATER STANDARDS.

GRADING TABULATION:
 TOTAL AMOUNT OF SITE TO BE GRADED: 0 S.F.
 % OF TOTAL SITE: 0%
 AMOUNT OF CUT: 13 CUBIC YARDS (AT MONOPINE CAISSON)
 MAXIMUM DEPTH OF CUT: 21 FEET (AT MONOPINE CAISSON)
 AMOUNT OF FILL: 0 CUBIC YARDS
 MAXIMUM DEPTH OF FILL: 0 FEET
 MAXIMUM HEIGHT OF FILL SLOPE: 0 FEET
 MAXIMUM HEIGHT OF CUT SLOPE: 0 FEET
 AMOUNT OF TRENCHING: 42 CUBIC YARDS
 MAXIMUM DEPTH OF TRENCH: 4 FEET
 AMOUNT OF IMPORT/EXPORT: 13 CUBIC YARDS
 RETAINING/CRIB WALLS LENGTH: 0 FEET
 MAXIMUM RETAINING WALL HEIGHT: 0 FEET

BENCHMARK:
 CITY OF SAN DIEGO, CALIFORNIA, BENCH MARK, VERTICAL CONTROL, INDEX NO. 1988, 17525.
 ELEVATION: 358.602 FEET A.M.S.L.

SITE PLAN
 1/16"=1'-0"

ARCHITECT

DI DONATO ASSOCIATES
 ARCHITECTURE + GRAPHICS
 3839 FIRST AVENUE, SUITE 100, SAN DIEGO, CA 92103
 619.259.4210 • 619.259.4250 FAX • DDAA@AOL.COM

PROJECT NAME

SD0563
ENCANTO STANDPIPE (SKYLINE)
 6780 AVIATION DRIVE, SAN DIEGO, CA 92114

ISSUES REVISIONS

DATE	BY	ISSUE DESCRIPTION
03-10-10	BDH	FOR SUBMITAL
11-30-10	BDH	REV 0 PER CITY COMMENTS
03-10-11	BDH	REV 1 PER CITY COMMENTS
05-02-11	BDH	REV 2 PER CITY COMMENTS
04-10-12	BDH	REV 3 PER CITY COMMENTS
05-02-12	BDH	REV 4 PER CITY COMMENTS
05-18-12	JLZ	REV 5 REVISED PER CITY COMMENTS
10-30-12	TJW	REV 6 PER CITY COMMENTS
01-21-13	RHA	REV 7 ANTENNAS CHANGED TO 8' TYPE

SHEET INFORMATION

DI DONATO ASSOCIATES
 ARCHITECTURE + GRAPHICS

Z01
 SITE PLAN

1003.24
 PLOT SCALE 1 : 1 (24x36" D SIZE)

THESE DESIGN DRAWINGS AND SPECIFICATIONS ARE THE PROPERTY AND COPYRIGHT OF DDA AND SHALL NOT BE USED IN CONNECTION WITH ANY OTHER WORK EXCEPT BY AGREEMENT WITH DDA. THERE SHALL BE NO CHANGES OR DEVIATIONS WITHOUT THE CONSENT OF DDA. WRITTEN DIMENSIONS SHALL BE VORDED ON THE JOB SITE. ANY DISCREPANCY SHALL BE BROUGHT TO THE NOTICE OF THE DDA PRIOR TO THE COMMENCEMENT OF ANY WORK.

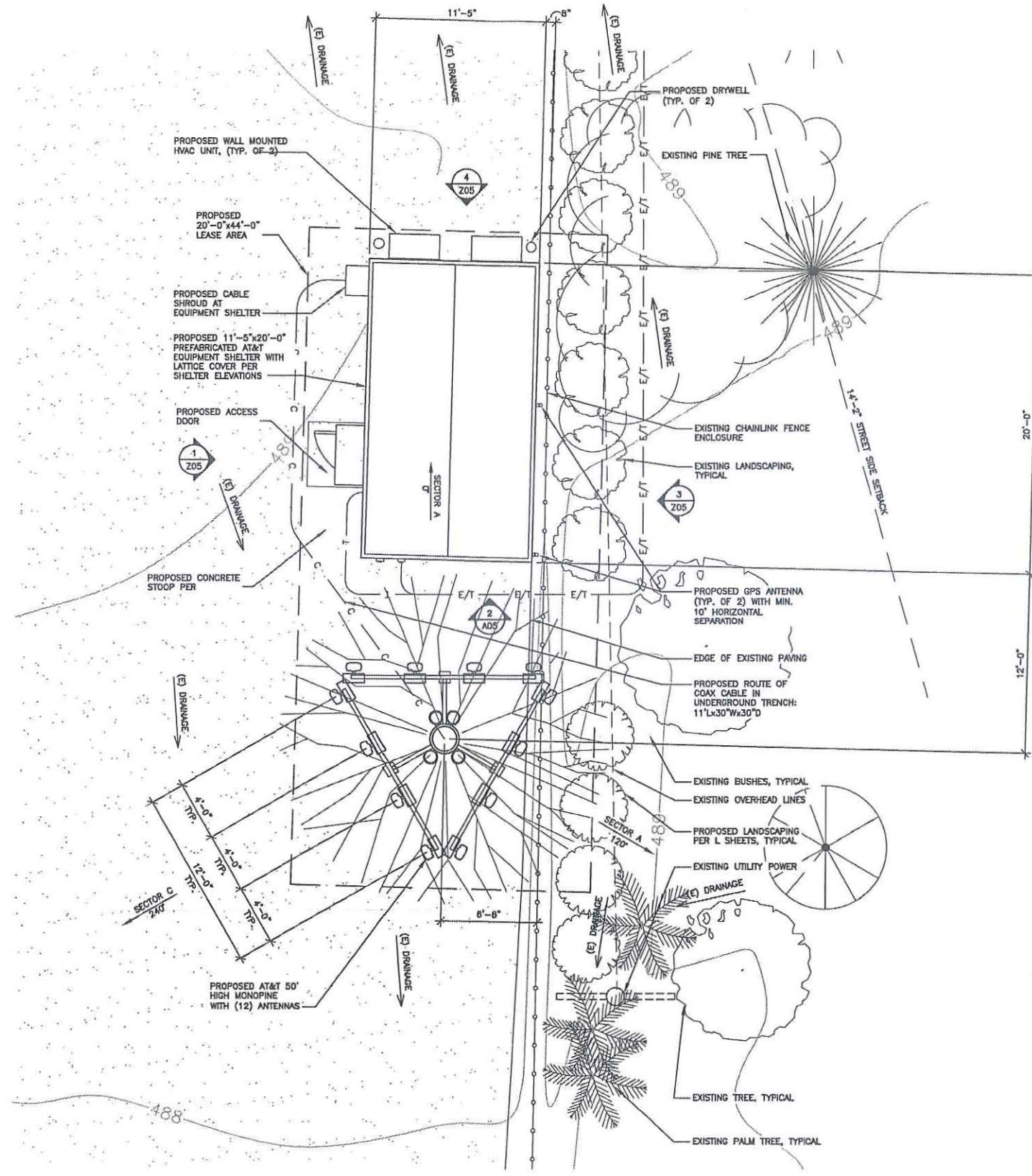

AREA PLAN
1/4"=1'-0"

ARCHITECT



DI DONATO ASSOCIATES
ARCHITECTURE + GRAPHICS
3838 FIRST AVENUE, SUITE 100, SAN DIEGO, CA 92103
619.259.4210 • 619.259.4200 FAX • DDANAME@AOL.COM

PROJECT NAME

SD0563
ENCANTO STANDPIPE (SKYLINE)
6780 AVANTON DRIVE, SAN DIEGO, CA 92114



ISSUES REVISIONS

DATE	BY	ISSUE DESCRIPTION
11-25-10	BDH	BOOK FOR REVIEW
03-30-11	BDH	REV 0 FOR SUBMITAL
05-02-11	BDH	REV 1 PER CITY COMMENTS
04-10-12	BDH	REV 2 PER CITY COMMENTS
05-02-12	BDH	REV 3 PER CSRF
06-18-12	JLZ	REV 4 PER CITY COMMENTS
10-30-12	JLZ	REV 5 REVISED PER CITY COMMENTS
01-21-13	RHA	REV 6 PER CITY COMMENTS
		REV 7 ANTENNAS CHANGED TO 6" TYPE

SHEET INFORMATION

DI DONATO ASSOCIATES
ARCHITECTURE + GRAPHICS

Z02
AREA PLAN

THESE DESIGN DRAWINGS AND SPECIFICATIONS ARE THE PROPERTY AND COPYRIGHT OF DDA AND SHALL NOT BE USED IN CONNECTION WITH ANY OTHER WORK EXCEPT BY AGREEMENT WITH DDA. THERE SHALL BE NO CHANGES OR DEVIATIONS WITHOUT THE CONSENT OF DDA. WRITTEN PERMISSIONS SHALL BE OBTAINED FROM THE JOB SITE. ANY DISCREPANCY SHALL BE BROUGHT TO THE NOTICE OF THE DDA PRIOR TO THE COMMENCEMENT OF ANY WORK.

DATE	BY	ISSUE DESCRIPTION
11-23-10	BDH	BOOK FOR REVIEW
11-30-10	BDH	REV 0 FOR SUBMITTAL
05-07-11	BDH	REV 1 PER CITY COMMENTS
04-10-12	BDH	REV 2 PER CITY COMMENTS
05-02-12	BDH	REV 3 PER CSDF
05-02-12	BDH	REV 4 PER CSDF
06-18-12	JLZ	REV 5 REVISED PER CITY COMMENTS
10-30-12	TJL	REV 6 PER CITY COMMENTS
01-21-13	RHA	REV 7 ANTENNAS CHANGED TO 6" TYPE

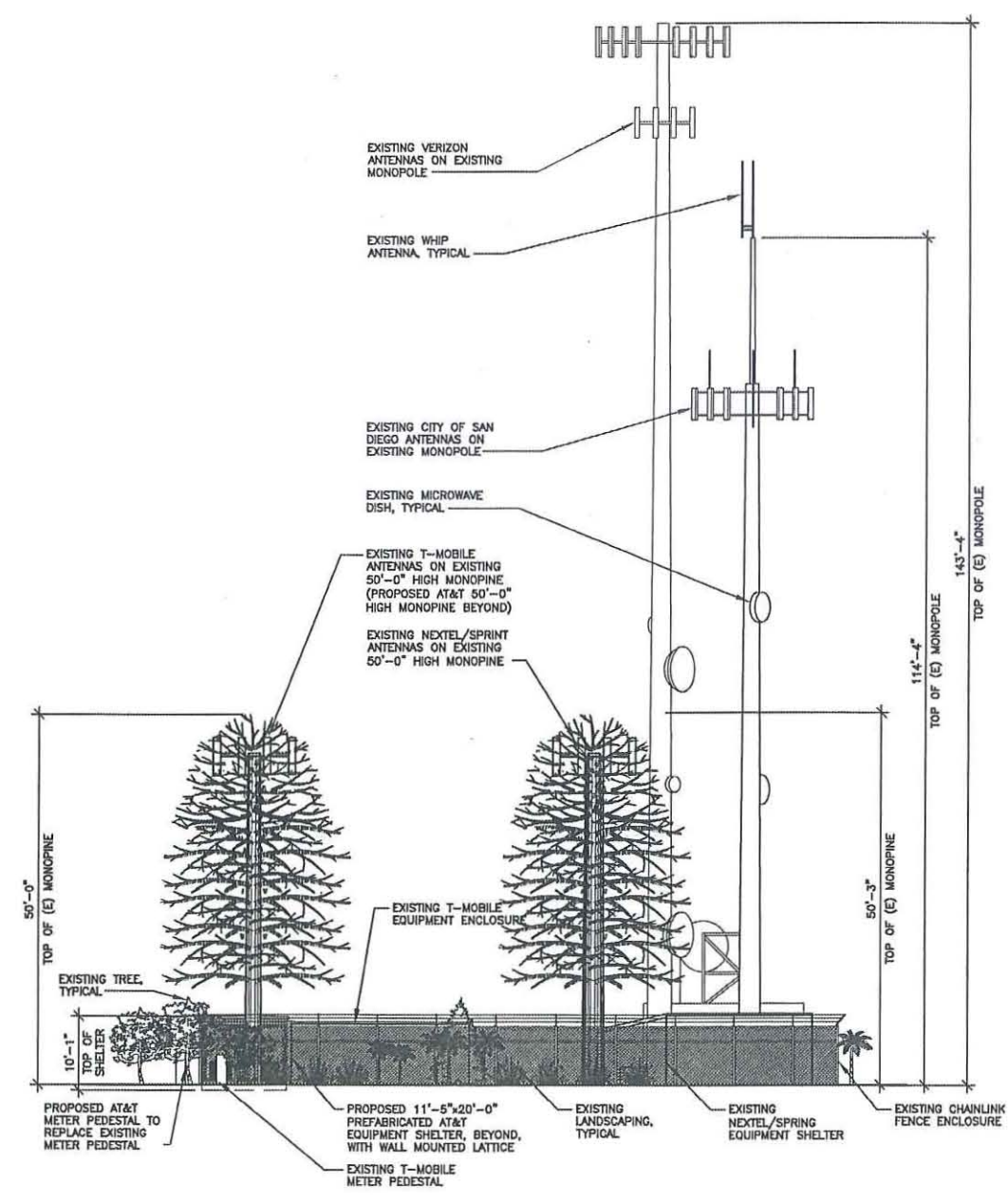

NORTH ELEVATION
 3/32"=1'-0"

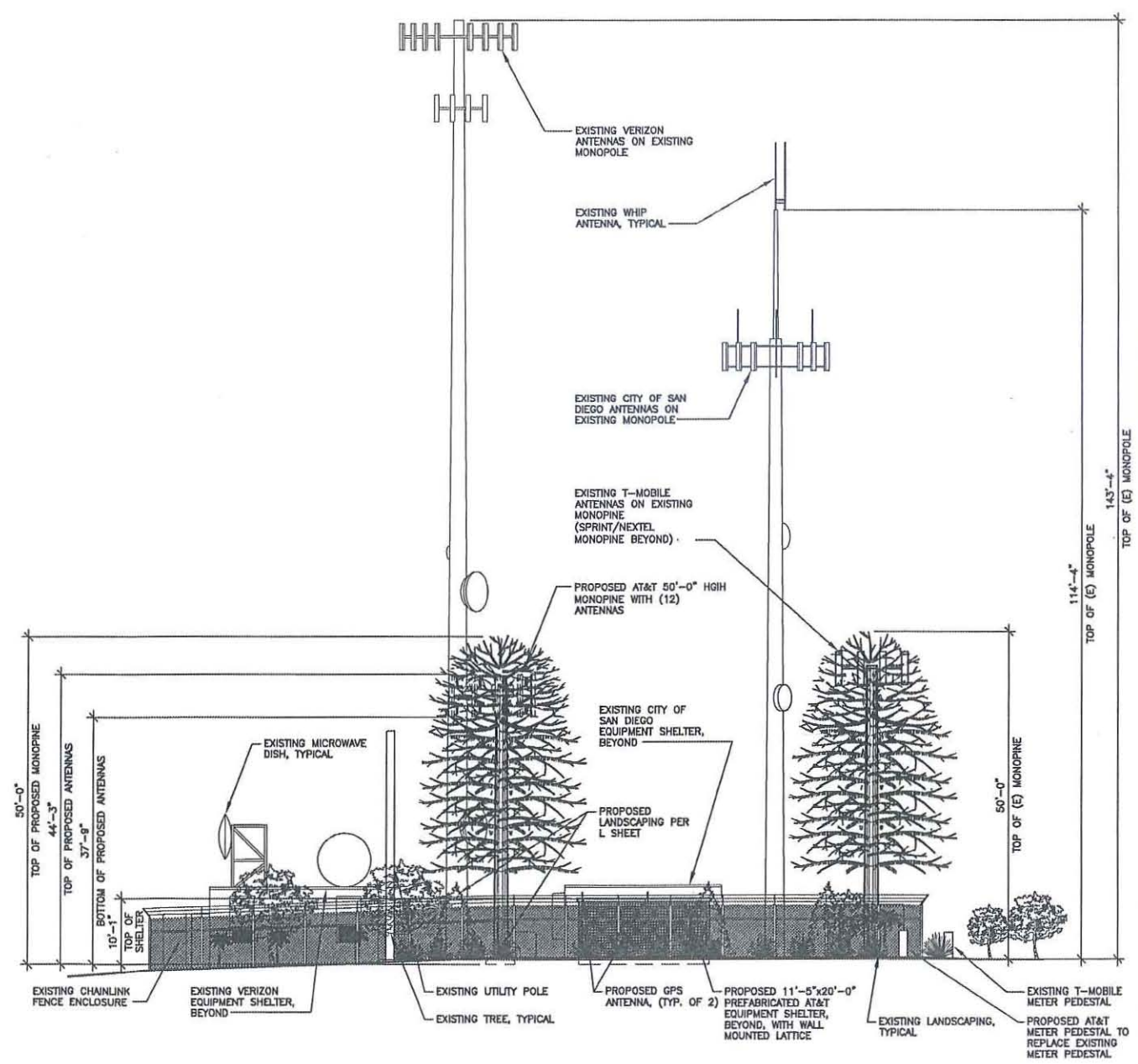

EAST ELEVATION
 3/32"=1'-0"



DI DONATO ASSOCIATES
ARCHITECTURE + GRAPHICS
3939 FIRST AVENUE - SUITE 100 - SAN DIEGO - CA 92103
619.299.4210 - 619.299.4259 FAX - DDAMARK@AOL.COM



SD0563
ENCANTO STANDPIPE (SKYLINE)
6780 AVANTON DRIVE, SAN DIEGO, CA 92114

DATE	BY	ISSUE DESCRIPTION
11-23-10	BDH	80% FOR REVIEW
11-30-10	BDH	REV 0 FOR SUBMITTAL
03-10-11	BDH	REV 1 PER CITY COMMENTS
05-02-11	BDH	REV 2 PER CITY COMMENTS
04-10-12	BDH	REV 3 RRUS COUNT
05-02-12	BDH	REV 4 PER CSRF
05-18-12	JLZ	REV 5 REVISED PER CITY COMMENTS
10-30-12	TJW	REV 6 PER CITY COMMENTS
01-21-13	RRM	REV 7 ANTENNAS CHANGED TO 'B' TYPE

DI DONATO ASSOCIATES
ARCHITECTURE + GRAPHICS
Z04
ELEVATIONS

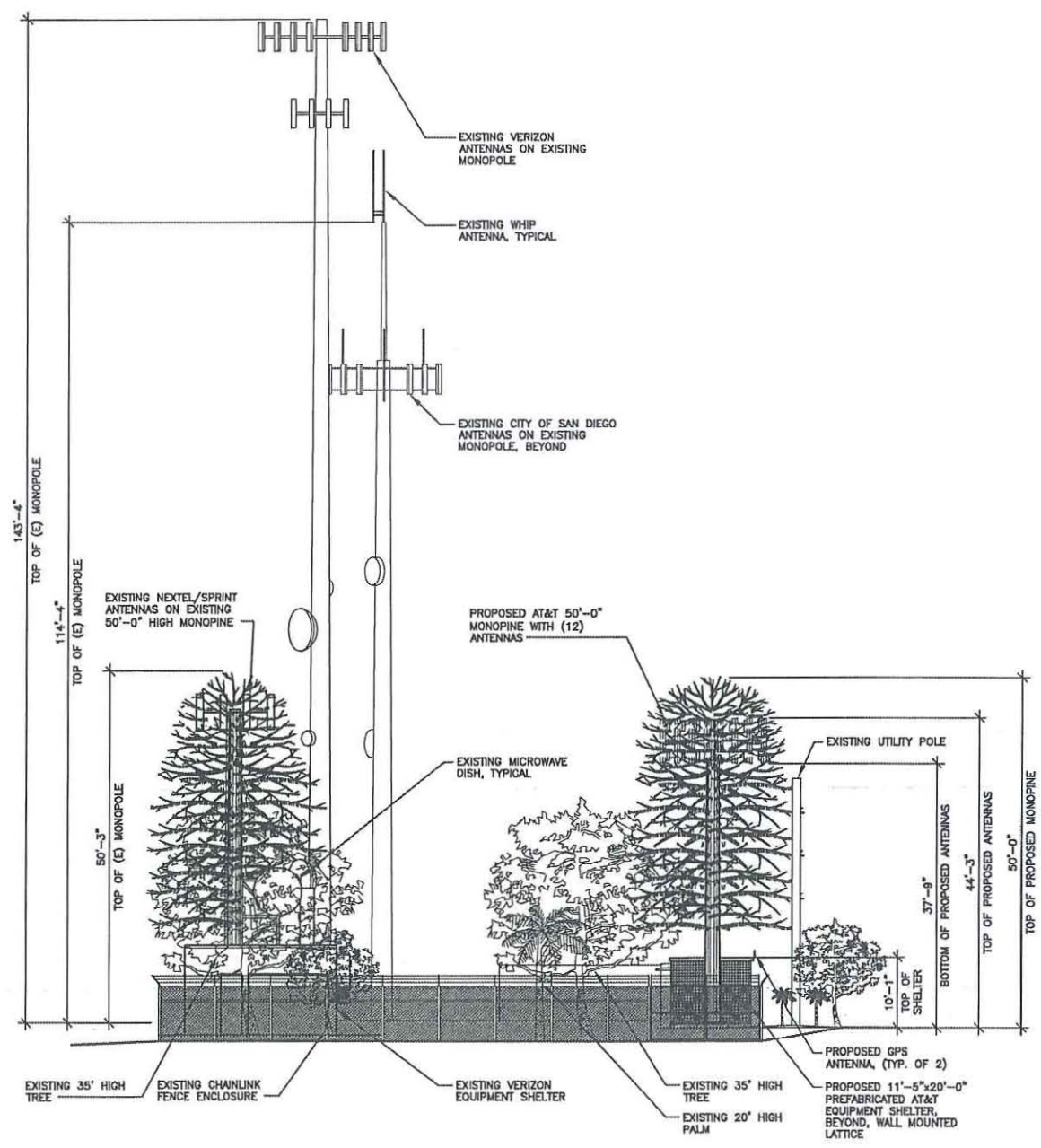

SOUTH ELEVATION
3/32"=1'-0"

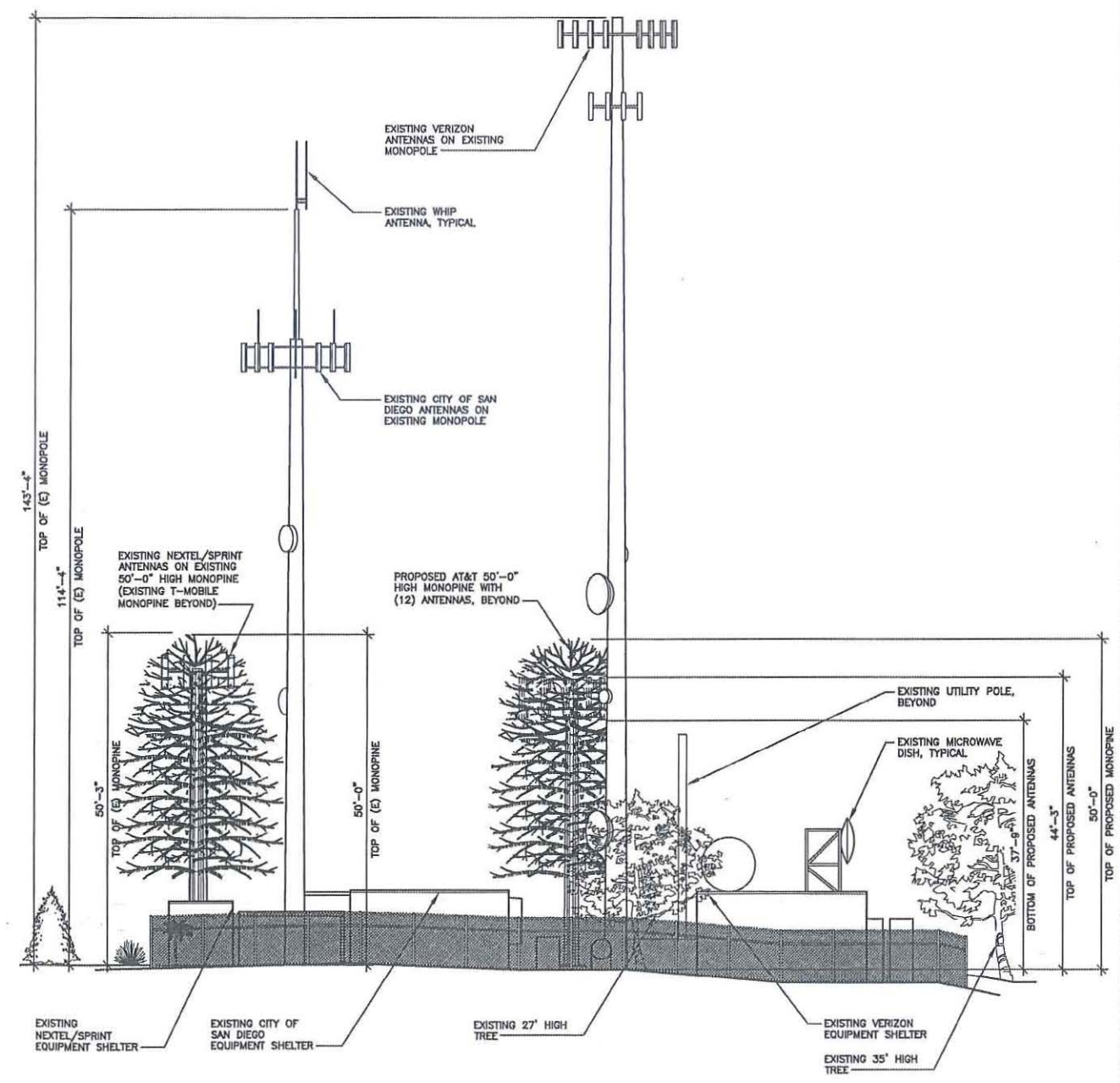

WEST ELEVATION
3/32"=1'-0"

THESE DESIGN DRAWINGS AND SPECIFICATIONS ARE THE PROPERTY AND COPYRIGHT OF DD&A AND SHALL NOT BE USED IN CONNECTION WITH ANY OTHER WORK EXCEPT BY AGREEMENT WITH DD&A. NO CHANGES OR DEVIATIONS WITHOUT THE CONSENT OF DD&A. WRITTEN DIMENSIONS SHALL BE VERIFIED ON THE JOB SITE. ANY DISCREPANCY SHALL BE BROUGHT TO THE NOTICE OF THE DD&A PRIOR TO THE COMMENCEMENT OF ANY WORK.



DI DONATO ASSOCIATES
ARCHITECTURE + GRAPHICS
3939 FIRST AVENUE - SUITE 100 - SAN DIEGO - CA 92103
619.299.4210 - 619.299.4250 FAX - DDAA@AIA.COM

SD0563
ENCANTO STANDPIPE (SKYLINE)
6780 AVANTON DRIVE, SAN DIEGO, CA 92114



DATE	BY	ISSUE DESCRIPTION
11-23-10	BDH	60% FOR REVIEW
11-30-10	BDH	REV 0 FOR SUBMITTAL
03-10-11	BDH	REV 1 PER CITY COMMENTS
05-02-11	BDH	REV 2 PER CITY COMMENTS
04-10-12	BDH	REV 3 RRUS COUNT
05-09-12	BDH	REV 4 PER CSR#
06-18-12	JLZ	REV 5 REVISED PER CITY COMMENTS
10-30-12	TJL	REV 6 PER CITY COMMENTS
01-21-13	RHA	REV 7 ANTENNAS CHANGED TO 6" TYPE

DI DONATO ASSOCIATES
ARCHITECTURE + GRAPHICS
Z05
ANTENNA DETAILS

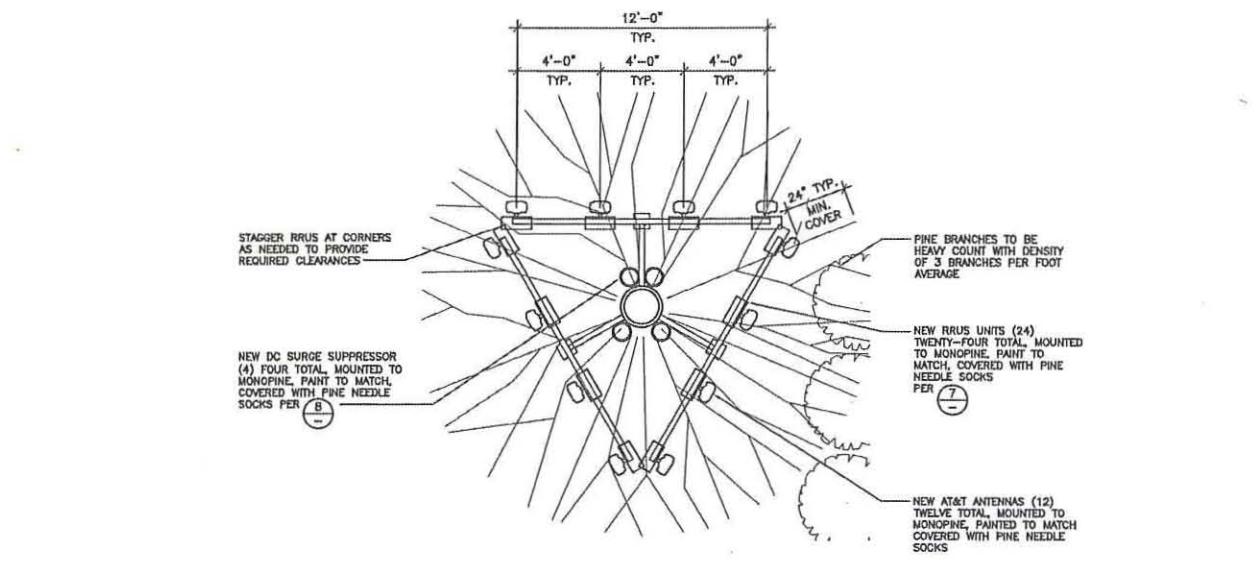

PLAN AT ANTENNAS
1/4"=1'-0"

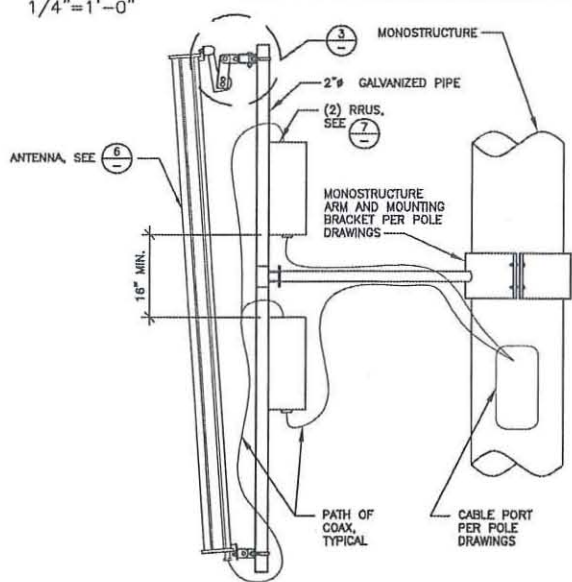

TYPICAL ANTENNA MOUNT
3/4"=1'-0"

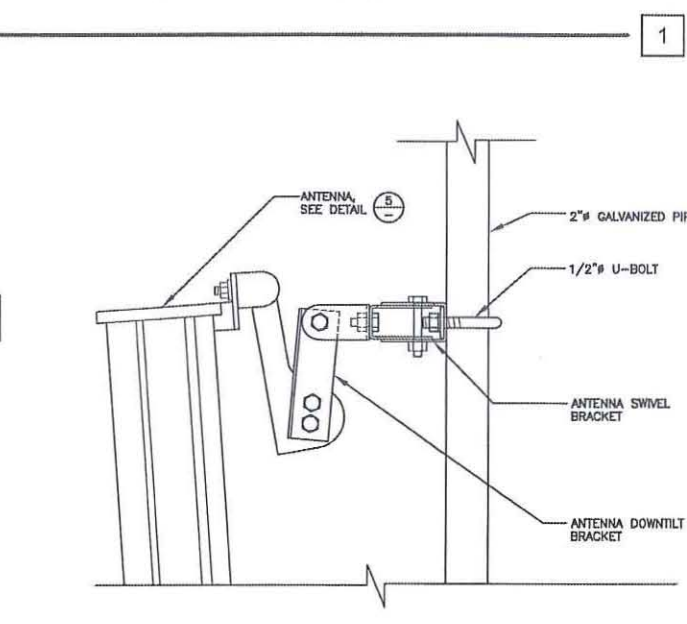

ANTENNA BRACKET ATTACHMENT
3"=1'-0"

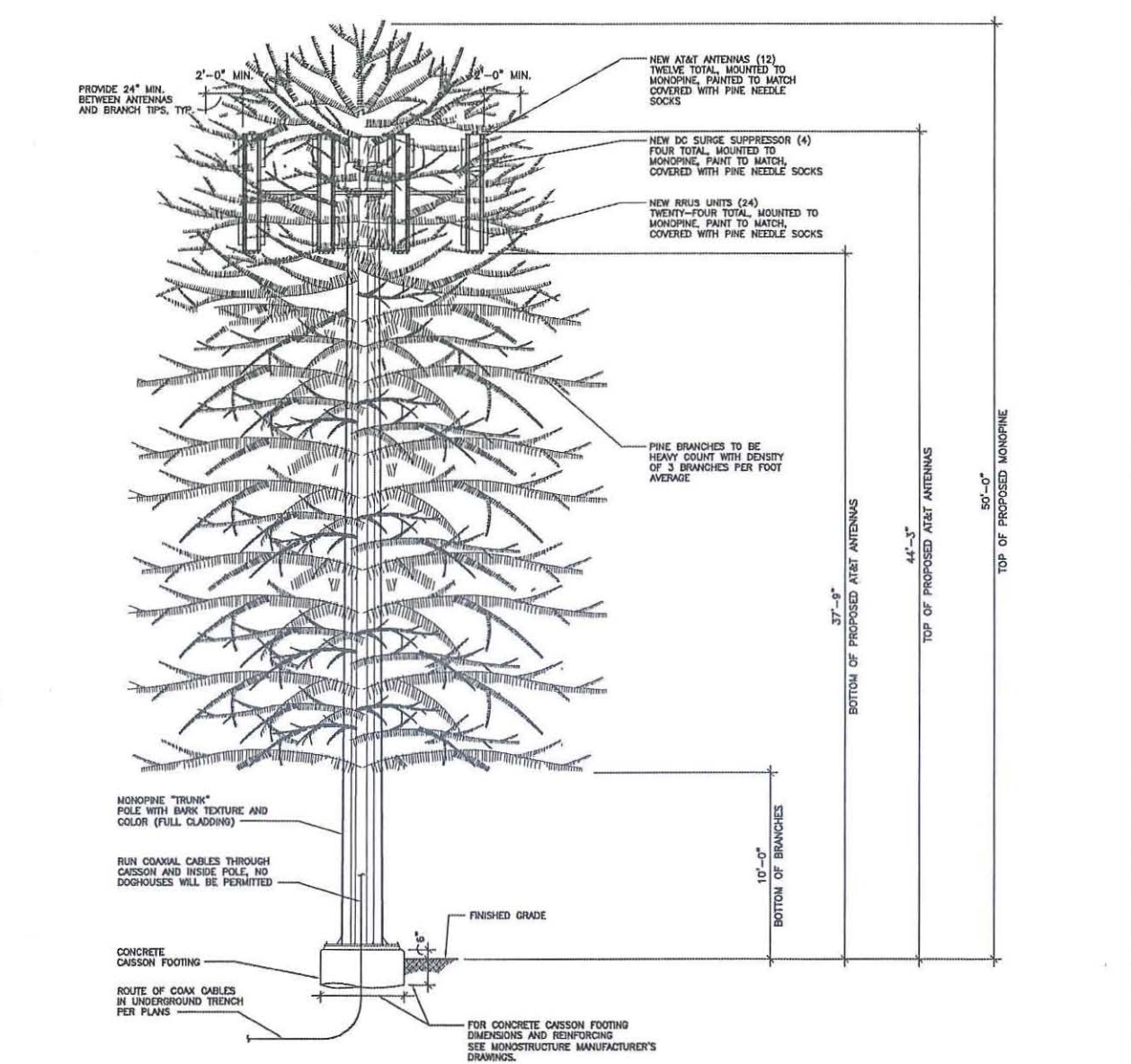

MONOSTRUCTURE
1/4"=1'-0"

NOT USED
NTS



ANTENNA
3/4"=1'-0"

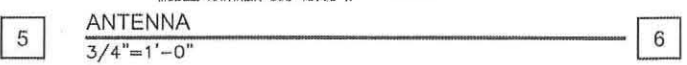

RRUS UNIT
1-1/2"=1'-0"

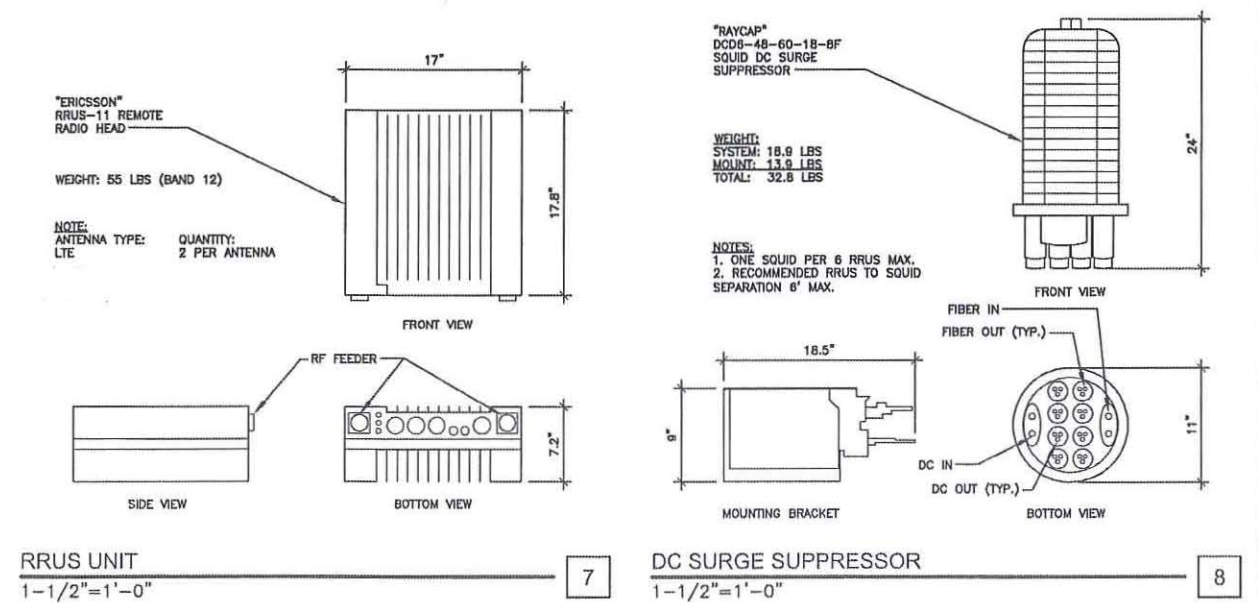

DC SURGE SUPPRESSOR
1-1/2"=1'-0"

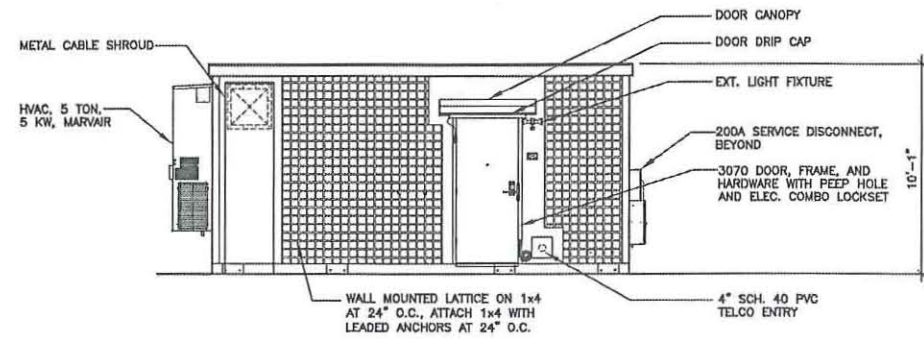

SHELTER IS SHOWN FOR REFERENCE ONLY. PLEASE REFER TO SHELTER DRAWINGS FOR ADDITIONAL INFORMATION AND SPECIFIC DETAILS, UTILITY CONNECTION LOCATIONS, ETC.

SHELTER ELEVATION
1/4"=1'-0"

1

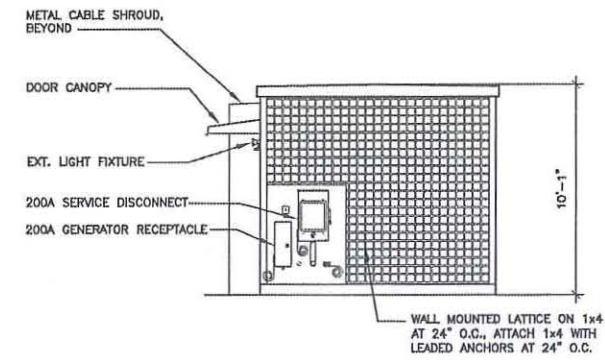

SHELTER IS SHOWN FOR REFERENCE ONLY. PLEASE REFER TO SHELTER DRAWINGS FOR ADDITIONAL INFORMATION AND SPECIFIC DETAILS, UTILITY CONNECTION LOCATIONS, ETC.

SHELTER ELEVATION
1/4"=1'-0"

2

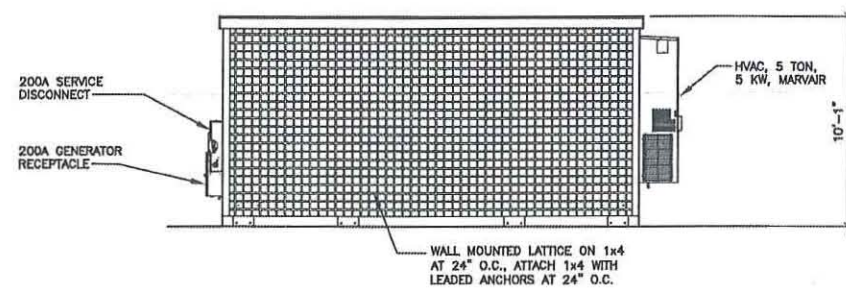

SHELTER IS SHOWN FOR REFERENCE ONLY. PLEASE REFER TO SHELTER DRAWINGS FOR ADDITIONAL INFORMATION AND SPECIFIC DETAILS, UTILITY CONNECTION LOCATIONS, ETC.

SHELTER ELEVATION
1/4"=1'-0"

3

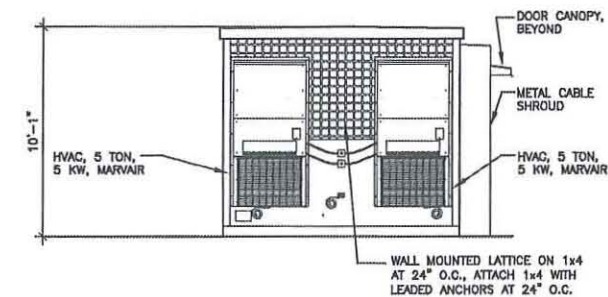

SHELTER IS SHOWN FOR REFERENCE ONLY. PLEASE REFER TO SHELTER DRAWINGS FOR ADDITIONAL INFORMATION AND SPECIFIC DETAILS, UTILITY CONNECTION LOCATIONS, ETC.

SHELTER ELEVATION
1/4"=1'-0"

4

ARCHITECT



DI DONATO ASSOCIATES
ARCHITECTURE + GRAPHICS
3838 FIRST AVENUE, SUITE 103, SAN DIEGO, CA 92103
619.294.4310 • 619.299.4289 FAX • DDONATO@DAAI.COM

PROJECT NAME

SD0563
ENCANTO STANDPIPE (SKYLINE)
6780 AVATION DRIVE, SAN DIEGO, CA 92114



ISSUES REVISIONS

DATE	BY	ISSUE DESCRIPTION
11-25-10	BDH	BOX FOR REVIEW
03-10-11	BDH	REV 0 FOR SUBMITTAL
05-02-11	BDH	REV 1 PER CITY COMMENTS
04-10-12	BDH	REV 2 PER CITY COMMENTS
05-02-12	BDH	REV 3 REVISE COUNT
05-02-12	BDH	REV 4 PER CSRF
05-18-12	JLZ	REV 5 REVISED PER CITY COMMENTS
10-30-12	TLW	REV 6 PER CITY COMMENTS
01-21-13	RVA	REV 7 ANTENNAS CHANGED TO 6" TYPE

SHEET INFORMATION

DI DONATO ASSOCIATES
ARCHITECTURE + GRAPHICS
Z06
SHELTER ELEVATIONS

THESE DESIGN CHANGES AND SPECIFICATIONS ARE THE PROPERTY AND COPYRIGHT OF DDA AND SHALL NOT BE USED IN CONNECTION WITH ANY OTHER WORK EXCEPT BY AGREEMENT WITH DDA. THESE SHALL BE NO CHANGE OF ELEVATION WITHOUT THE CONSENT OF DDA. WRITTEN DIMENSIONS SHALL BE GIVEN ON THE JOB SITE. ANY DISCREPANCY SHALL BE BROUGHT TO THE NOTICE OF THE DDA PRIOR TO THE COMMENCEMENT OF ANY WORK.

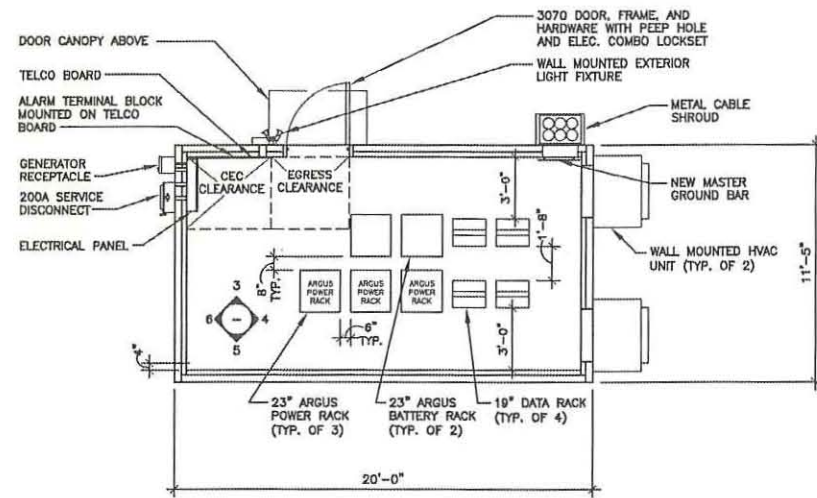

EQUIPMENT PLAN
1/4"=1'-0"

NOTE TO CONTRACTOR:
THE FOLLOWING ITEMS ARE TO BE INCLUDED BY THE GENERAL CONTRACTOR AND SHOULD BE INCLUDED IN THE BID:
- (1) BROOM
- (1) DUST PAN
- (1) WET/DRY SHOP VACUUM CLEANER (VAULTS ONLY) GRAINGER MODEL #4YJ67 OR EQUIVALENT
- FIRST AID KIT WITH A BLOOD BORNE PATHOGEN KIT, GRAINGER MODEL #5M562 & 6T401 OR EQUIVALENT
- EYE WASH KIT
- (1) DESK, SPACE PERMITTING, GRAINGER MODEL J4GU45 OR EQUIVALENT
- (1) CHAIR, GRAINGER MODEL #1WB85 OR EQUIVALENT
THE FOLLOWING WILL NOT BE INCLUDED:
- STEP LADDERS
- FLOOR MOPS

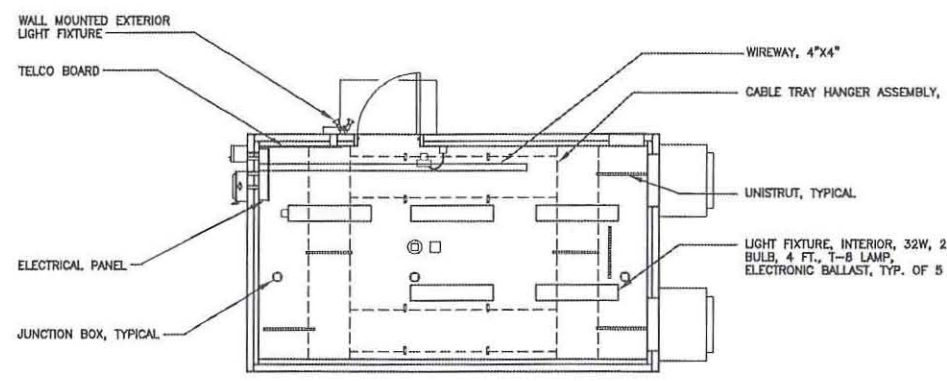

REFLECTED CEILING PLAN
1/4"=1'-0"

SHELTER IS SHOWN FOR REFERENCE ONLY. PLEASE REFER TO SHELTER DRAWINGS FOR ADDITIONAL INFORMATION AND SPECIFIC DETAILS, UTILITY CONNECTION LOCATIONS, ETC.

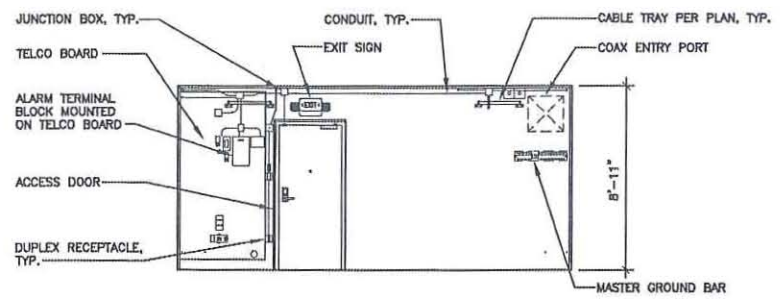

INTERIOR ELEVATION
1/4"=1'-0"

SHELTER IS SHOWN FOR REFERENCE ONLY. PLEASE REFER TO SHELTER DRAWINGS FOR ADDITIONAL INFORMATION AND SPECIFIC DETAILS, UTILITY CONNECTION LOCATIONS, ETC.

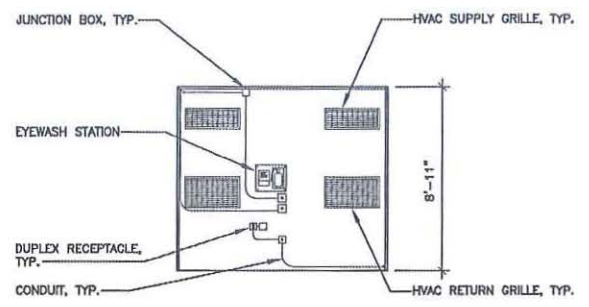

INTERIOR ELEVATION
1/4"=1'-0"

SHELTER IS SHOWN FOR REFERENCE ONLY. PLEASE REFER TO SHELTER DRAWINGS FOR ADDITIONAL INFORMATION AND SPECIFIC DETAILS, UTILITY CONNECTION LOCATIONS, ETC.

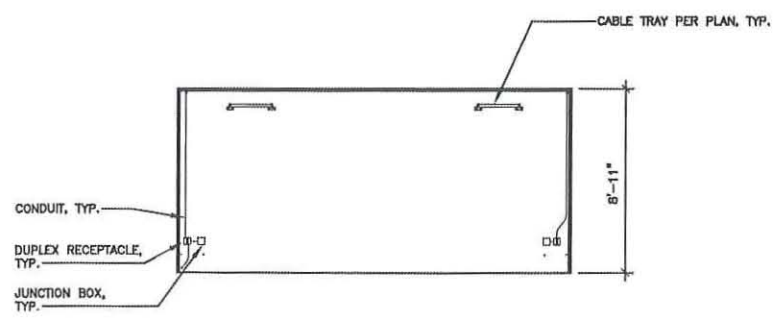

INTERIOR ELEVATION
1/4"=1'-0"

SHELTER IS SHOWN FOR REFERENCE ONLY. PLEASE REFER TO SHELTER DRAWINGS FOR ADDITIONAL INFORMATION AND SPECIFIC DETAILS, UTILITY CONNECTION LOCATIONS, ETC.

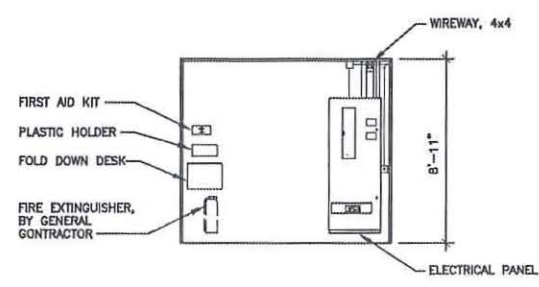

INTERIOR ELEVATION
1/4"=1'-0"

SHELTER IS SHOWN FOR REFERENCE ONLY. PLEASE REFER TO SHELTER DRAWINGS FOR ADDITIONAL INFORMATION AND SPECIFIC DETAILS, UTILITY CONNECTION LOCATIONS, ETC.

DI DONATO ASSOCIATES
ARCHITECTURE + GRAPHICS
3833 FIRST AVENUE, SUITE 100 - SAN DIEGO, CA 92103
619.298.4210 - 619.298.4250 FAX - DDAMAIL@AOL.COM

PROJECT NAME

at&t
SD0563
ENCANTO STANDPIPE (SKYLINE)
6780 AVIATION DRIVE, SAN DIEGO, CA 92114

ISSUES REVISIONS

DATE	BY	ISSUE DESCRIPTION
11-23-10	BNH	60% FOR REVIEW
11-30-10	BNH	REV 0 FOR SUBMITTAL
03-10-11	BNH	REV 1 PER CITY COMMENTS
05-02-11	BNH	REV 2 PER CITY COMMENTS
04-10-12	BNH	REV 3 BRUS COUNT
05-02-12	BNH	REV 4 PER CSRF
06-18-12	JLZ	REV 5 REVISED PER CITY COMMENTS
10-30-12	TJW	REV 6 PER CITY COMMENTS
01-21-13	RVA	REV 7 ANTENNAS CHANGED TO 6' TYPE

SHEET INFORMATION

DI DONATO ASSOCIATES
ARCHITECTURE + GRAPHICS
Z07
EQUIPMENT PLANS,
INTERIOR ELEVATIONS

THESE DRAWINGS AND SPECIFICATIONS ARE THE PROPERTY AND COPYRIGHT OF DDA AND SHALL NOT BE USED IN CONNECTION WITH ANY OTHER WORK EXCEPT BY AGREEMENT WITH DDA. WRITTEN PERMISSIONS SHALL BE OBTAINED FROM THE JOB FILE. ANY DISCREPANCY SHALL BE INDICATED TO THE NOTICE OF THE OWNER PRIOR TO THE COMMENCEMENT OF ANY WORK.