

3.0 EXISTING CONDITIONS

This section summarizes the existing conditions within the Barrio Logan community with respect to the following:

- Roadway and Freeway Segments
- Intersections
- Parking
- Truck Traffic

Roadway & Freeways Segments

The following section provides a description of the existing study streets within the Barrio Logan community. Functional roadway classifications for the different roadways in the study area were based on field observations.

Cesar Chavez Parkway functions as a north-south, 4-lane collector between Logan Avenue and National Avenue and between Main Street and Harbor Drive. This road functions as a 3-lane collector between Logan Avenue and Kearny Avenue and between National Avenue and Main Street. Cesar Chavez Parkway is lined with sidewalks and curbs on both sides of the road, for the entire length of the street. Parallel parking is available on the west side of the street between National Avenue and Main Street. Signs prohibit trucks above five tons from traveling along Cesar Chavez Parkway. A northbound, I-5 on-ramp is located at the intersection of Cesar Chavez Parkway and Kearny Avenue. A westbound, SR-75 on-ramp is located at the intersection of Cesar Chavez Parkway and Logan Avenue. The posted speed limit is 30 miles per hour (mph).

Sampson Street functions as a north-south, 2-lane collector between I-5 and Harbor Drive. Sidewalks, curbs, and parallel parking spaces are located on both sides of the road. Trucks above five tons are prohibited by signage to travel along Sampson Street. The speed limit along Sampson Street is 25 mph within the study area.

26th Street functions as a north-south, 2-lane collector between Logan Avenue and Main Street. Sidewalks, curbs, and parallel parking spaces are located on both sides of the road. Signs prohibit trucks above five tons from traveling along 26th Street. The posted speed limit is 25 mph.

28th Street functions as a north-south, 4-lane collector between Boston Avenue and Main Street and a 4-lane with raised median major arterial between Main Street and Harbor Drive. Between National Avenue and Boston Avenue, 28th Street functions as a three-lane collector with two northbound lanes and a southbound lane. This street is a designated truck route. Sidewalks and curbs line both sides of the street for the entire length of the segment. Parallel parking is available on both sides of the street between Main Street and Harbor Drive. The NASSCO shipyard is located at the southern end of 28th Street. South of Main Street, Naval Base San Diego fronts on the east side of 28th Street, including an access gate to the base. I-5 on and off-ramps connect 28th Street to I-5 near the northern end of the segment. The posted speed limit is 30 mph.

32nd Street functions as a north-south, 2-lane collector between Main Street and Wabash Street and a 4-lane major arterial between Wabash Street and Harbor Drive. Between Wabash Street and Harbor Drive, 32nd Street has additional auxiliary lane for the northbound and southbound directions. This segment is a designated truck route. Sidewalks and curbs are located on both sides of the road. 32nd Street provides access to I-15 via Wabash Street, which functions as an on and off-ramp. South of Main Street, 32nd Street is completely fronted by Navy property. The entrance to Naval Base San Diego is located at the south end of 32nd Street. The speed limit along 32nd Street is 30 mph within the study area.

Rigel Street functions as a north-south, 2-lane collector between Dalbergia Street and I-5. This segment has sidewalks, curbs, and parallel parking spaces on both sides of the street. The posted speed limit is 25 mph.

Vesta Street functions as a north-south, 2-lane collector between Dalbergia Street and I-5. The road has sidewalks, curbs, and parallel parking spaces on both sides of the road. The posted speed limit is 25 mph.

Logan Avenue functions as an east-west, 2-lane collector between 17th Street and Sampson Street. This road has a two-way left-turn lane. Logan Avenue has a southbound I-5 off-ramp at the intersection with Beardsley Street and a southbound I-5 on-ramp located between Cesar Chavez Parkway and Evans Street. Signs prohibit trucks above five tons from traveling along Logan Avenue. This segment has sidewalks, curbs, and parallel parking on both sides of the road. The posted speed limit is 25 mph.

National Avenue functions as an east-west, 2-lane collector between 16th Street and 27th Street and a 4-lane collector between Commercial Street and 16th Street. Trucks above five tons are prohibited by signage to travel along National Avenue. An eastbound, SR-75 off-ramp is located along National Avenue between Cesar Chavez Parkway and Evans Street. This segment of National Avenue has sidewalks, curbs, and parallel parking on both sides of the road. Diagonal parking is provided on National Avenue on the south side of the street for portions of the segment between Beardsley Street and Evans Street. The posted speed limit is 30 mph.

Boston Avenue functions as an east-west, 2-lane collector between 28th Street and 32nd Street. This road has sidewalks, curbs, and parallel parking spaces on both sides of the street. A southbound, I-5 on-ramp is located at the intersection with 29th Street. The posted speed limit is 25 mph.

Main Street functions as an east-west, 2-lane collector between Beardsley Street and 26th Street and between Rigel Street and Yama Street. Main Street functions as a 3-lane collector between 26th Street and 27th Street and between 29th Street and 32nd Street, and a 4-lane collector between 27th Street and 29th Street and between 32nd Street and Rigel Street. Curbs and sidewalks are located on both sides of the road, along the entire length of the segment. Signs prohibit trucks over five tons from traveling on Main Street, west of 26th Street. A northbound I-15 on-ramp and a southbound I-15 off-ramp is located between 32nd Street and Rigel Street. Southbound I-5 on and off-ramps are also located near the intersection with Yama Street. Main Street is a designated class III bikeway. Parallel parking is intermittently permitted along both sides of the road. The posted speed limit is 35 mph.

Harbor Drive functions as an east-west, 4-lane major arterial between Sigsbee Street and Vesta Street. The road has a raised or landscaped median along the entire length of the segment. Harbor Drive is a designated truck route and has a class II bikeway with bike lanes along both sides of the road. The street has intermittent curbs, sidewalks, and parallel parking along the northern side of the road. The southern side of Harbor Drive has limited curbs and sidewalks. Parallel parking is intermittently permitted between Schley Street and 32nd Street. The posted speed limit is 40 and 45 mph.

Interstate 5 is classified and functions as an 8-lane freeway with four main lanes of traffic in each direction. Interstate 5 provides connections for the community to locations to the north and the south within the region.

Interstate 15 is classified and functions as a 6-lane freeway with three main lanes of traffic in each direction. Interstate 15 provides connections to locations to the east and north within the region. Interstate 15 is a major truck corridor in Southern California.

San Diego-Coronado Bridge is classified and functions as a 5-lane freeway. The traffic lanes on the bridge are separated by a movable median, which allows for three westbound traffic lanes in the morning and three eastbound traffic lanes in the afternoon and evening. The approach on each side of the bridge contains three lanes. An out-of-service toll plaza is located on the west side of the bridge and serves as a traffic calming

device for vehicles entering the island. The San Diego-Coronado Bridge is designated as State Route (SR) 75. The posted speed limit is 50 mph.

Figure 3-1 shows the existing geometrics of the study intersections within the study area and **Figure 3-2** shows the functional classification for the roadway segments in the study area.

Traffic Volumes

The peak-hour intersection turning movements at study area intersections were obtained from several sources. Where appropriate, traffic counts from previous studies were utilized since traffic volumes generally remained constant. For the counts listed in the Year 2003, traffic data was obtained from the *Barrio Logan Truck Study*, prepared by Willdan. For the counts listed in the Year 2005/2006, traffic data was obtained from the *Mercado Traffic Study*, prepared by Darnell and Associates. For the counts listed in June 2008, traffic data was obtained by National Data and Surveying Services. For the counts listed in the December 2008, traffic data was obtained from Caltrans Port Access Study.

Similar to the study area intersections, the roadway segment traffic data were obtained from several sources. All of the ramp volumes for I-5 and I-15 were obtained from Caltrans with most of the data coming from 2005/2006. All of the segment counts prior to the Year 2008 were obtained from the *Barrio Logan Truck Study*, prepared by Willdan, *Mercado Traffic Study*, prepared by Darnell and Associates, City of San Diego, and Wilson and Company. For the counts listed in the Year 2008 and 2010, traffic data was obtained by National Data and Surveying Services.

Freeway ADTs and peak-hour volumes were taken from Caltrans' traffic database and they correspond to the year 2008.

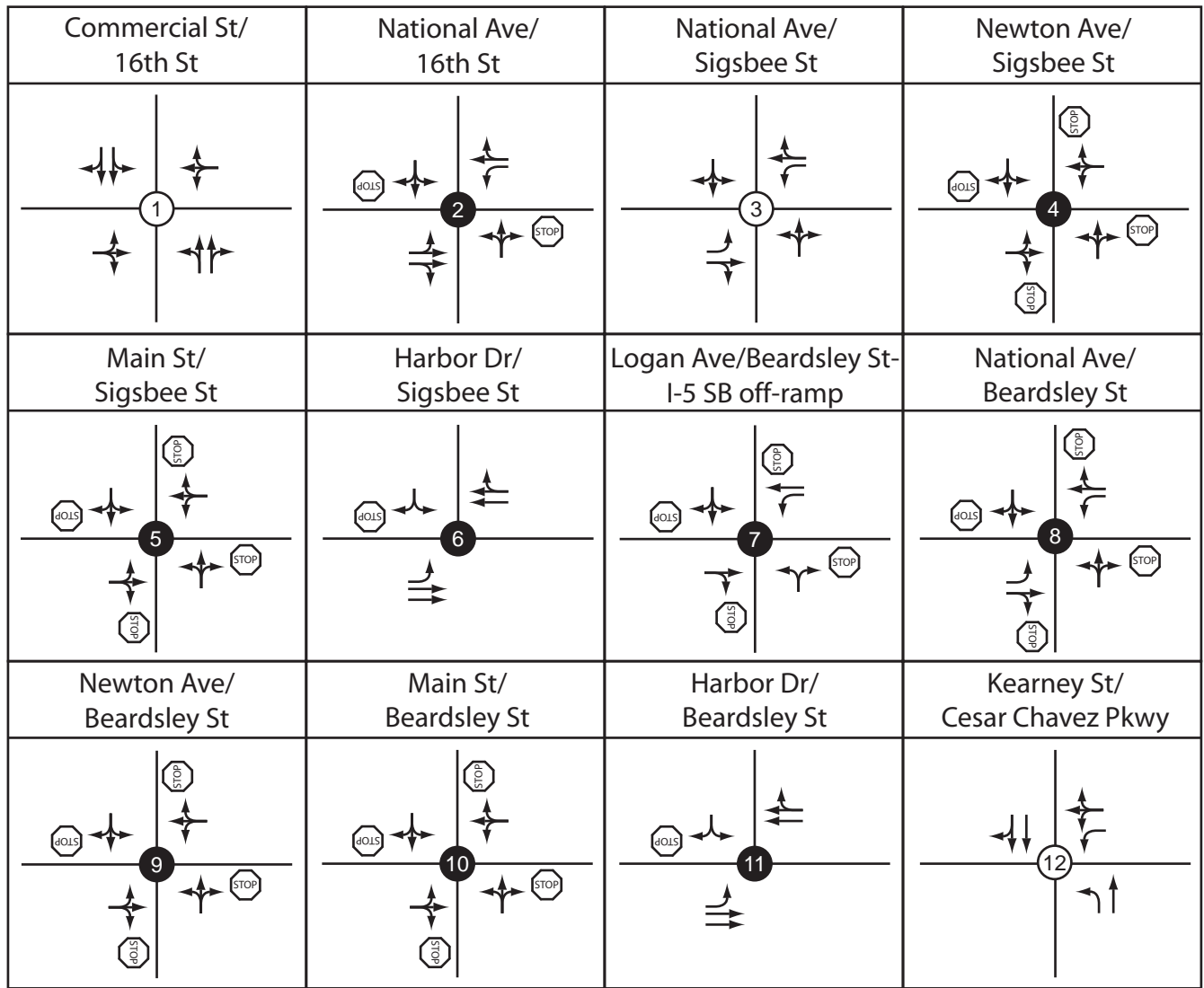

Legend:

- Signalized
- Unsignalized



NOT TO SCALE

Barrio Logan Community Plan Update

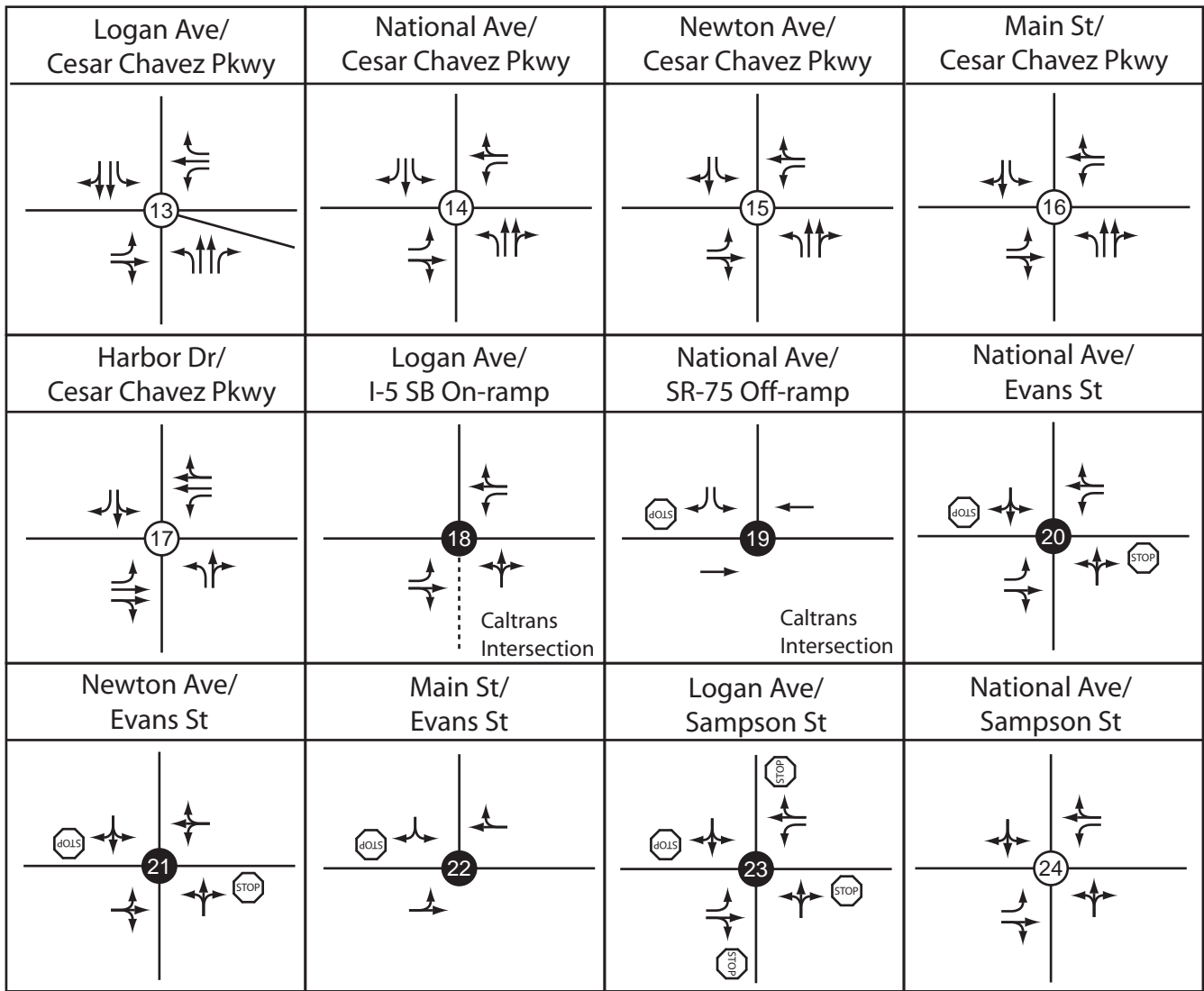

Legend:

- Signalized
- Unsignalized



NOT TO SCALE

K:\TPTO\095707000\Illustrator\EX int geometry 13-24.ai

Barrio Logan Community Plan Update

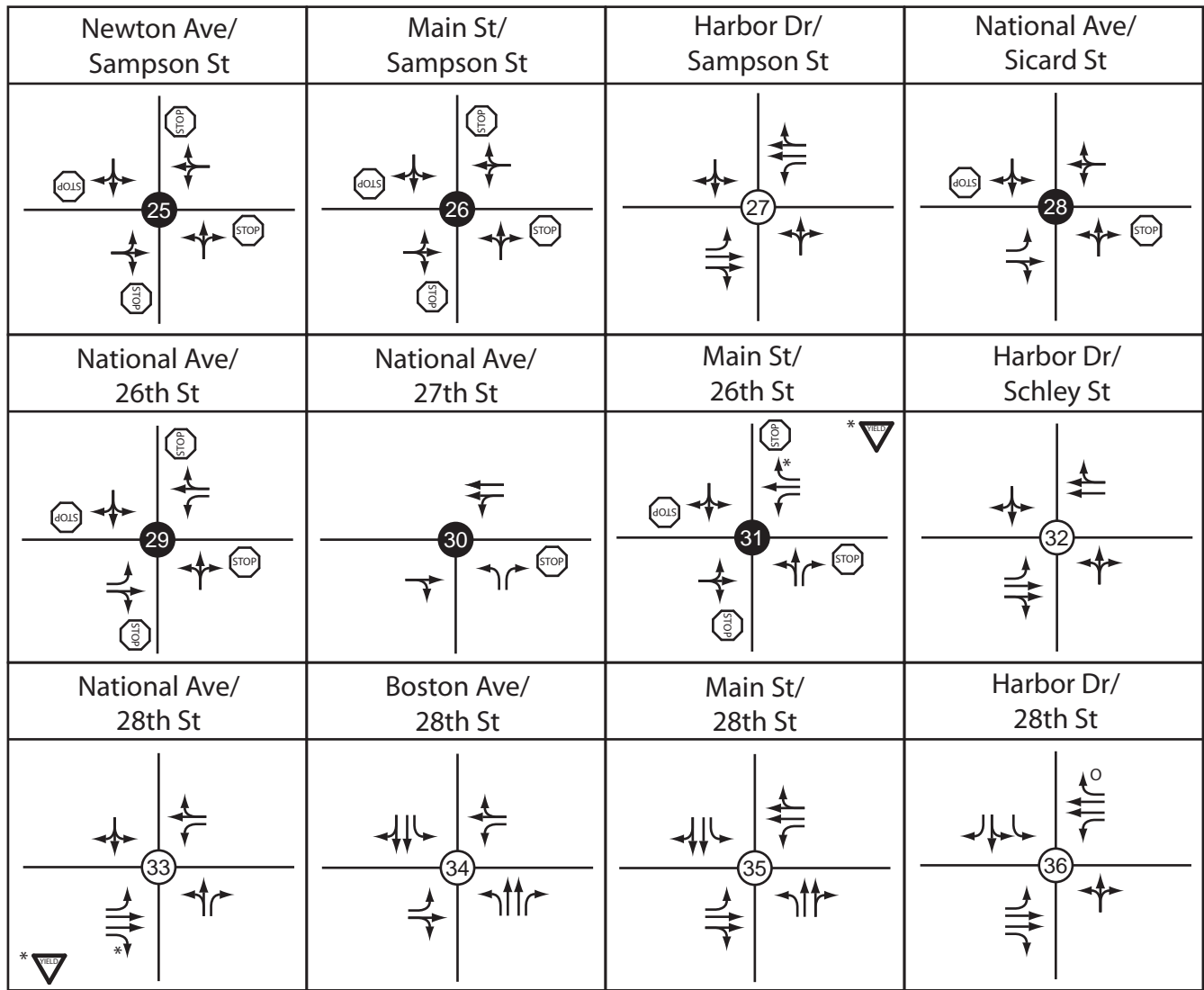

Legend:

- X Signalized
- X Unsignalized
- o Right-turn overlap





NOT TO SCALE

K:\TPTO\095707000\Illustrator\EX int geometry 25-36.ai

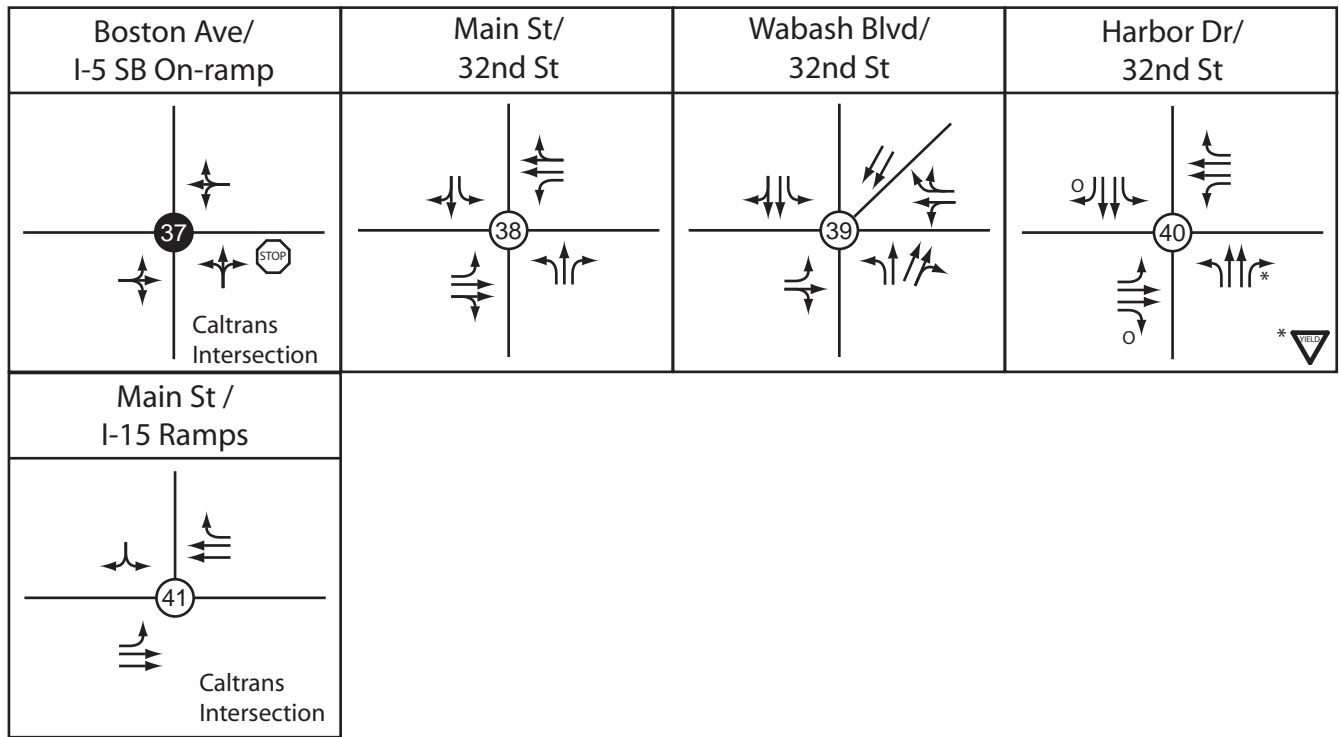
Barrio Logan Community Plan Update



Legend:

-  Signalized
-  Unsignalized
-  Right-turn overlap



NOT TO SCALE



THIS MAP IS PROVIDED WITHOUT WARRANTY OF ANY KIND, EITHER EXPRESS OR IMPLIED, INCLUDING BUT NOT LIMITED TO, THE IMPLIED WARRANTIES OF MERCHANTABILITY AND FITNESS, FOR A PARTICULAR PURPOSE. Copyright SanGIS. All Rights Reserved.
 This product may contain information from the SANDAG Regional Information System which cannot be reproduced without written permission of SANDAG.
 This product may contain information which has been reproduced with permission granted by Thomas Bros. Maps.

LEGEND

- Barrio Logan Community Plan Area
- City Boundary
- Freeway/Ramp
- SDMTS Trolley and Station
- Park/Open Space
- School
- Port District
- Naval Station San Diego
- 2-Lane Collector (without TWLT)-(60' to 80' ROW)
- 2-Lane Collector (with TWLT)-(80' ROW)
- 3-Lane Collector (without TWLT)-(80' ROW)
- 3-Lane Collector (with TWLT)-(ROW varies)
- 4-Lane Collector (without TWLT)(80' ROW)
- 4-Lane Collector (with TWLT)(ROW varies)
- 4-Lane Major (ROW varies)
- X Freeway main lane



Figure 3-2: Existing Roadway Functional Classification

Table 3-1 summarizes the date of the counts for the study intersections and **Table 3-2** summarizes the date of the counts for roadway segments. The existing traffic volume data is contained in **Appendix C**.

Figure 3-3 illustrates the existing peak-hour traffic volumes at the study intersections. **Figure 3-4** illustrates the existing ADT volumes along the roadway segments in the study area.

TABLE 3-1	
STUDY INTERSECTIONS COUNT SOURCE DATA	
Intersection	Date of Count (a)
1 Commercial St & 16th St	6/3/08
2 National Ave & 16th St	6/3/08
3 National Ave & Sigsbee St	6/5/08
4 Newton Ave & Sigsbee St	6/4/08
5 Main St & Sigsbee St	6/4/08
6 Harbor Dr & Sigsbee St	12/2/08
7 Logan Ave & I-5 SB off-ramp	12/2/08
8 National Ave & Beardsley St	6/5/08
9 Newton Ave & Beardsley St	6/5/08

Notes:
 (a) Traffic counts in the Year 2006 were obtained from the *Mercado Traffic Study* performed by Darnell and Associates. Traffic counts in the Year 2008 were obtained by National Data and Surveying Services and from the Port Access Study being prepared by Caltrans.

TABLE 3-1
STUDY INTERSECTIONS COUNT SOURCE DATA (cont.)

Intersection	Date of Count (a)
10 Main St & Beardsley St	6/5/08
11 Harbor Dr & Beardsley St	2/16/06
12 Kearny Ave & Cesar Chavez Pkwy	12/2/08
13 Logan Ave & Cesar Chavez Pkwy/SR-75 on-ramp	6/5/08
14 National Ave & Cesar Chavez Pkwy	12/2/08
15 Newton Ave & Cesar Chavez Pkwy	12/2/08
16 Main St & Cesar Chavez Pkwy	6/5/08
17 Harbor Dr & Cesar Chavez Pkwy	6/4/08
18 Logan Ave & I-5 SB on-ramp	12/2/08
19 National Ave & SR-75 off-ramp	12/2/08
20 National Ave & Evans St	3/7/06
21 Newton Ave & Evans St	3/7/06
22 Main St & Evans St	12/2/08
23 Logan Ave & Sampson St	3/15/06
24 National Ave & Sampson St	6/5/08
25 Newton Ave & Sampson St	6/5/08
26 Main St & Sampson St	6/10/08
27 Harbor Dr & Sampson St	6/11/08
28 National Ave & Sicard St	6/10/08
29 National Ave & 26th St	6/10/08
30 National Ave & I-5 SB off-ramp	6/11/08
31 Main St & 26th St	6/10/08
32 Harbor Dr & Schley St	6/10/08
33 National Ave & 28th St	12/2/08
34 Boston Ave & 28th St	12/2/08
35 Main St & 28th St	6/11/08
36 Harbor Dr & 28th St	6/11/08
37 Boston Ave & 29th St/I-5 SB on-ramp	12/2/08
38 Main St & 32nd St	6/12/08
39 Wabash & 32nd St	12/2/08
40 Harbor Dr & 32nd St	6/12/08
41 Main St & I-15 ramps	6/12/08

Notes:

(a) Traffic counts in the Year 2006 were obtained from the *Mercado Traffic Study* performed by Darnell and Associates. Traffic counts in the Year 2008 were obtained by National Data and Surveying Services and from the Port Access Study being prepared by Caltrans.

TABLE 3-2
ROADWAY SEGMENT COUNT SOURCE DATA

Roadway Segment	Date of Count (a)
1 I-5 SB Off Ramp at Beardsley St	2005
2 I-5 SB On Ramp at Logan Ave	2005
3 I-5 SB Off Ramp at 27th St	2005
4 I-5 SB Off Ramp at 28th St	2005
5 I-5 SB On Ramp at Boston Ave	2006
6 I-5 SB Off Ramp at Main St	2006
7 I-15 SB Off Ramp at Main St	2006
8 I-15 NB On Ramp at Main St	1998
9 SR-75 Off Ramp at National Ave	6/10/08
10 SR-75 On Ramp at Cesar Chavez Pkwy	6/10/08
11 Cesar Chavez Pkwy north of Logan Ave	2/3/10
12 Cesar Chavez Pkwy between Logan Ave and National Ave	2/9/10
13 Cesar Chavez Pkwy between National Ave and Newton Ave	6/10/08
14 Cesar Chavez Pkwy between Newton Ave and Main St	2/3/10
15 Cesar Chavez Pkwy between Main St and Harbor Dr	6/10/08
16 Sampson St between I-5 and National Ave	6/10/08
17 Sampson St between National Ave and Harbor Dr	6/10/08
18 26th St between National Ave and Newton Ave	2/03
19 28th St north of I-5 SB Off ramp	6/11/08
20 28th St between I-5 and Main St	6/11/08
21 28th St between Main St and Harbor Dr	6/11/08
22 32nd St between Main St and Wabash Blvd	6/11/08
23 32nd St between Wabash Blvd and Harbor Drive	6/11/08
24 Rigel St between Dalbergia St and I-5	6/11/08
25 Vesta St between Dalbergia St and I-5	1/06
26 Logan Ave between 17th St and Sigsbee St	12/07
27 Logan Ave between I-5 SB Off ramp and Cesar Chavez Pkwy	2/3/10
28 Logan Ave between Evans St and Sampson St	6/10/08
29 National Ave between Commercial St and 16th St	2/04
30 National Ave between 16th St and Sigsbee St	12/07
31 National Ave between Sigsbee St and Beardsley St	2003
32 National Ave between Beardsley St and Cesar Chavez Pkwy	6/10/08
33 National Ave between Cesar Chavez Pkwy and Evans St	2/3/10
34 National Ave between Evans St and Sampson St	2/3/10
35 National Ave between Sampson St and 27th St	6/10/08
36 Boston Ave between 29th St and 30th St	6/10/08
37 Main St between Beardsley St and Cesar Chavez Pkwy	2/3/10

Notes:

(a) Traffic counts at the I-5 and I-15 ramps were provided by Caltrans. Traffic counts prior to the Year 2008 were obtained from the *Barrio Logan Truck Study* performed by Willdan, *Mercado Traffic Study* performed by Darnell and Associates, City of San Diego, and Wilson and Company. Traffic counts in the Year 2008 and 2010 were obtained by National Data and Surveying Services.

TABLE 3-2.1
ROADWAY SEGMENT COUNT SOURCE DATA (cont.)

Roadway Segment	Date of Count (a)
38 Main St between Cesar Chavez Pkwy and Sampson St	6/10/08
39 Main St between 26th St and 28th St	10/06
40 Main St between 28th St and 32nd St	6/10/08
41 Main St between 32 nd St and Rigel St	1999
42 Main St between Rigel St and Siva St	1/06
43 Main St between Dalbergia St and I-5 SB Off Ramp	1/07
44 Harbor Dr between Beardsley St and Cesar Chavez Pkwy	6/10/08
45 Harbor Dr between Cesar Chavez Pkwy and Sampson St	2/3/10
46 Harbor Dr between Sampson St and Schley St	6/11/08
47 Harbor Dr between Schley St and 28th St	6/11/08
48 Harbor Dr between 28th St and 32nd St	6/11/08
49 Harbor Dr between 32nd St and Vesta St	10/03

Notes:

(a) Traffic counts at the I-5 and I-15 ramps were provided by Caltrans. Traffic counts prior to the Year 2008 were obtained from the *Barrio Logan Truck Study* performed by Willdan, *Mercado Traffic Study* performed by Darnell and Associates, City of San Diego, and Wilson and Company. Traffic counts in the Year 2008 were obtained by National Data and Surveying Services.

Barrio Logan Community Plan Update

<p>1</p> <p>↔ 29 / 19 ↔ 49 / 16 ↔ 7 / 6</p> <p>16th St</p> <p>↔ ↕ ↔ 22 / 24 ↔ ↕ ↔ 125 / 192 ↔ ↕ ↔ 13 / 0</p> <p>Commercial St</p> <hr/> <p>↔ ↕ ↔ 3 / 18 ↔ ↕ ↔ 83 / 131 ↔ ↕ ↔ 19 / 11</p> <p>↔ ↕ ↔ 9 / 14 ↔ ↕ ↔ 20 / 21 ↔ ↕ ↔ 9 / 12</p>	<p>2</p> <p>↔ 13 / 7 ↔ 36 / 25 ↔ 24 / 16</p> <p>16th St</p> <p>↔ ↕ ↔ 25 / 25 ↔ ↕ ↔ 101 / 90 ↔ ↕ ↔ 3 / 3</p> <p>National Ave</p> <hr/> <p>↔ ↕ ↔ 4 / 8 ↔ ↕ ↔ 30 / 74 ↔ ↕ ↔ 14 / 8</p> <p>↔ ↕ ↔ 11 / 15 ↔ ↕ ↔ 34 / 41 ↔ ↕ ↔ 12 / 7</p>	<p>3</p> <p>↔ 18 / 8 ↔ 40 / 23 ↔ 4 / 3</p> <p>Sigsbee St</p> <p>↔ ↕ ↔ 15 / 11 ↔ ↕ ↔ 79 / 54 ↔ ↕ ↔ 11 / 7</p> <p>National Ave</p> <hr/> <p>↔ ↕ ↔ 2 / 5 ↔ ↕ ↔ 22 / 73 ↔ ↕ ↔ 26 / 31</p> <p>↔ ↕ ↔ 38 / 34 ↔ ↕ ↔ 26 / 55 ↔ ↕ ↔ 33 / 13</p>	<p>4</p> <p>↔ 15 / 7 ↔ 50 / 25 ↔ 13 / 6</p> <p>Sigsbee St</p> <p>↔ ↕ ↔ 20 / 8 ↔ ↕ ↔ 34 / 23 ↔ ↕ ↔ 3 / 1</p> <p>Newton Ave</p> <hr/> <p>↔ ↕ ↔ 5 / 8 ↔ ↕ ↔ 22 / 22 ↔ ↕ ↔ 12 / 17</p> <p>↔ ↕ ↔ 14 / 11 ↔ ↕ ↔ 75 / 58 ↔ ↕ ↔ 9 / 2</p>
<p>5</p> <p>↔ 2 / 1 ↔ 42 / 27 ↔ 31 / 20</p> <p>Sigsbee St</p> <p>↔ ↕ ↔ 61 / 31 ↔ ↕ ↔ 4 / 0 ↔ ↕ ↔ 6 / 10</p> <p>Main St</p> <hr/> <p>↔ ↕ ↔ 1 / 4 ↔ ↕ ↔ 5 / 1 ↔ ↕ ↔ 1 / 3</p> <p>↔ ↕ ↔ 1 / 0 ↔ ↕ ↔ 39 / 39 ↔ ↕ ↔ 5 / 1</p>	<p>6</p> <p>↔ 24 / 18 ↔ 12 / 23</p> <p>Sigsbee St</p> <p>↔ ↕ ↔ 20 / 13 ↔ ↕ ↔ 831 / 314</p> <p>Harbor Dr</p> <hr/> <p>↔ ↕ ↔ 22 / 82 ↔ ↕ ↔ 247 / 1163</p>	<p>7</p> <p>↔ 21 / 16 ↔ 151 / 73 ↔ 137 / 154</p> <p>I-5 SB Off-Ramp</p> <p>↔ ↕ ↔ 86 / 65 ↔ ↕ ↔ 45 / 24</p> <p>Logan Ave</p> <hr/> <p>↔ ↕ ↔ 68 / 210 ↔ ↕ ↔ 11 / 32</p> <p>↔ ↕ ↔ 16 / 27 ↔ ↕ ↔ 38 / 73</p>	<p>8</p> <p>↔ 23 / 11 ↔ 138 / 83 ↔ 20 / 29</p> <p>Beardsley St</p> <p>↔ ↕ ↔ 18 / 12 ↔ ↕ ↔ 71 / 77 ↔ ↕ ↔ 68 / 33</p> <p>National Ave</p> <hr/> <p>↔ ↕ ↔ 8 / 19 ↔ ↕ ↔ 41 / 96 ↔ ↕ ↔ 8 / 2</p> <p>↔ ↕ ↔ 4 / 9 ↔ ↕ ↔ 30 / 43 ↔ ↕ ↔ 13 / 43</p>
<p>9</p> <p>↔ 28 / 9 ↔ 137 / 81 ↔ 52 / 44</p> <p>Beardsley St</p> <p>↔ ↕ ↔ 15 / 19 ↔ ↕ ↔ 39 / 47 ↔ ↕ ↔ 16 / 6</p> <p>Newton Ave</p> <hr/> <p>↔ ↕ ↔ 13 / 5 ↔ ↕ ↔ 31 / 28 ↔ ↕ ↔ 3 / 1</p> <p>↔ ↕ ↔ 5 / 1 ↔ ↕ ↔ 23 / 66 ↔ ↕ ↔ 11 / 16</p>	<p>10</p> <p>↔ 52 / 17 ↔ 57 / 39 ↔ 20 / 15</p> <p>Beardsley St</p> <p>↔ ↕ ↔ 20 / 9 ↔ ↕ ↔ 90 / 33 ↔ ↕ ↔ 35 / 15</p> <p>Main St</p> <hr/> <p>↔ ↕ ↔ 15 / 22 ↔ ↕ ↔ 62 / 49 ↔ ↕ ↔ 4 / 4</p> <p>↔ ↕ ↔ 2 / 0 ↔ ↕ ↔ 8 / 25 ↔ ↕ ↔ 16 / 31</p>	<p>11</p> <p>↔ 54 / 16 ↔ 30 / 26</p> <p>Beardsley St</p> <p>↔ ↕ ↔ 16 / 16 ↔ ↕ ↔ 907 / 329</p> <p>Harbor Dr</p> <hr/> <p>↔ ↕ ↔ 13 / 60 ↔ ↕ ↔ 209 / 1167</p>	<p>12</p> <p>↔ 14 / 15 ↔ 192 / 250</p> <p>Cesar Chavez Pkwy</p> <p>↔ ↕ ↔ 60 / 113 ↔ ↕ ↔ 134 / 54 ↔ ↕ ↔ 516 / 415</p> <p>Kearney Ave</p> <hr/> <p>↔ ↕ ↔ 109 / 189 ↔ ↕ ↔ 106 / 262</p>

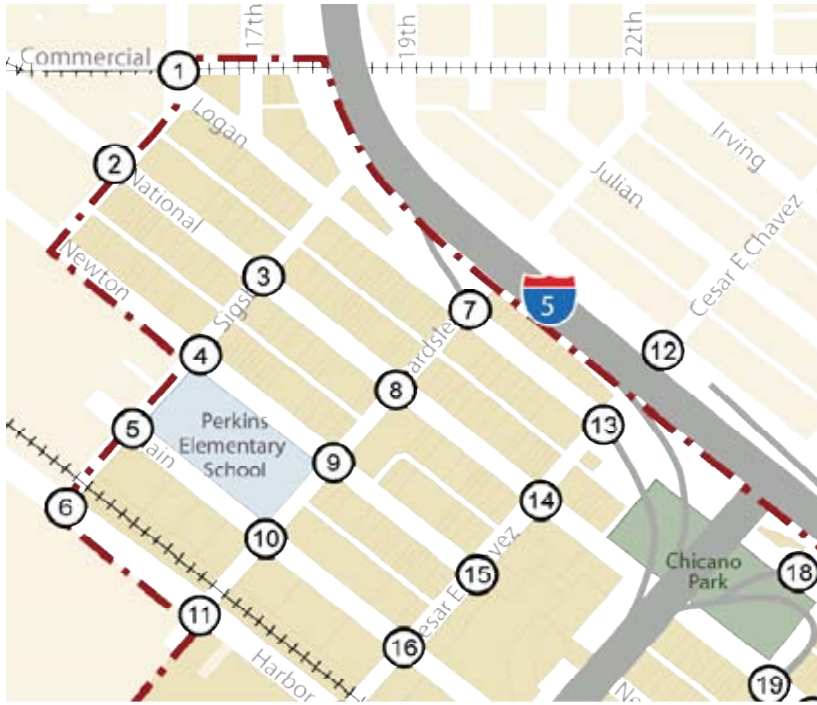

Legend
X / Y = AM / PM PEAK HOUR
TURNING VOLUMES



K:\SND_TPT\095707000\Excel\707000TA01.xlsx\Ex Figure 1-12

Barrio Logan Community Plan Update

<p>13</p> <p>61 / 39 ↔ ↔ 528 / 394 ↔ ↔ 70 / 114 ↔ ↔ Cesar Chavez Pkwy-SR-75 On- ramp ↔ ↔ 34 / 28 ↔ ↔ 19 / 19 ↔ ↔ 14 / 9</p> <p>Logan Ave</p> <p>54 / 97 ↔ ↔ 109 / 205 ↔ ↔ 69 / 44 ↔ ↔</p> <p>11 / 9 ↔ ↔ 140 / 254 ↔ ↔ 145 / 339</p>	<p>14</p> <p>117 / 65 ↔ ↔ 461 / 330 ↔ ↔ 39 / 77 ↔ ↔ Cesar Chavez Pkwy ↔ ↔ 54 / 75 ↔ ↔ 72 / 57 ↔ ↔ 90 / 51</p> <p>National Ave</p> <p>42 / 88 ↔ ↔ 29 / 75 ↔ ↔ 18 / 36 ↔ ↔</p> <p>14 / 16 ↔ ↔ 291 / 476 ↔ ↔ 8 / 30</p>	<p>15</p> <p>58 / 22 ↔ ↔ 406 / 316 ↔ ↔ 27 / 44 ↔ ↔ Cesar Chavez Pkwy ↔ ↔ 26 / 42 ↔ ↔ 28 / 21 ↔ ↔ 20 / 13</p> <p>Newton Ave</p> <p>28 / 52 ↔ ↔ 19 / 55 ↔ ↔ 16 / 21 ↔ ↔</p> <p>9 / 8 ↔ ↔ 217 / 459 ↔ ↔ 8 / 23</p>	<p>16</p> <p>82 / 34 ↔ ↔ 361 / 269 ↔ ↔ 25 / 26 ↔ ↔ Cesar Chavez Pkwy ↔ ↔ 45 / 60 ↔ ↔ 47 / 22 ↔ ↔ 25 / 18</p> <p>Main St</p> <p>56 / 53 ↔ ↔ 43 / 34 ↔ ↔ 1 / 7 ↔ ↔</p> <p>7 / 4 ↔ ↔ 155 / 455 ↔ ↔ 4 / 19</p>
<p>17</p> <p>330 / 247 ↔ ↔ 83 / 30 ↔ ↔ 50 / 33 ↔ ↔ Cesar Chavez Pkwy ↔ ↔ 76 / 43 ↔ ↔ 422 / 166 ↔ ↔ 55 / 19</p> <p>Harbor Dr</p> <p>107 / 375 ↔ ↔ 153 / 713 ↔ ↔ 16 / 12 ↔ ↔</p> <p>4 / 11 ↔ ↔ 14 / 63 ↔ ↔ 27 / 35</p>	<p>18</p> <p>53 / 51 ↔ ↔ 60 / 73 ↔ ↔</p> <p>Logan Ave</p> <p>251 / 473 ↔ ↔ 93 / 267 ↔ ↔ 1 / 5 ↔ ↔</p> <p>I-5 SB On-Ramp</p> <p>Park Dwy</p> <p>0 / 7 ↔ ↔ 1 / 1 ↔ ↔ 1 / 2</p>	<p>19</p> <p>156 / 133 ↔ ↔ 16 / 72 ↔ ↔ SR-75 Off-Ramp ↔ ↔ 142 / 134 ↔ ↔</p> <p>National Ave</p> <p>67 / 160 ↔ ↔</p>	<p>20</p> <p>16 / 37 ↔ ↔ 8 / 10 ↔ ↔ 5 / 27 ↔ ↔ Evans St ↔ ↔ 16 / 15 ↔ ↔ 123 / 103 ↔ ↔ 18 / 17</p> <p>National Ave</p> <p>7 / 18 ↔ ↔ 65 / 212 ↔ ↔ 9 / 14 ↔ ↔</p> <p>10 / 5 ↔ ↔ 26 / 8 ↔ ↔ 10 / 29</p>
<p>21</p> <p>17 / 11 ↔ ↔ 8 / 8 ↔ ↔ 1 / 8 ↔ ↔ Evans St ↔ ↔ 8 / 7 ↔ ↔ 24 / 27 ↔ ↔ 3 / 5</p> <p>Newton Ave</p> <p>12 / 13 ↔ ↔ 33 / 46 ↔ ↔ 9 / 16 ↔ ↔</p> <p>10 / 3 ↔ ↔ 19 / 15 ↔ ↔ 6 / 6</p>	<p>22</p> <p>14 / 7 ↔ ↔ 5 / 10 ↔ ↔ Evans St ↔ ↔ 7 / 9 ↔ ↔ 114 / 78</p> <p>Main St</p> <p>11 / 5 ↔ ↔ 52 / 87 ↔ ↔</p>	<p>23</p> <p>14 / 13 ↔ ↔ 82 / 100 ↔ ↔ 62 / 66 ↔ ↔ Sampson St ↔ ↔ 50 / 54 ↔ ↔ 62 / 75 ↔ ↔ 17 / 29</p> <p>Logan Ave</p> <p>90 / 101 ↔ ↔ 125 / 135 ↔ ↔ 28 / 36 ↔ ↔</p> <p>62 / 63 ↔ ↔ 112 / 134 ↔ ↔ 33 / 18</p>	<p>24</p> <p>25 / 18 ↔ ↔ 36 / 33 ↔ ↔ 19 / 36 ↔ ↔ Sampson St ↔ ↔ 24 / 28 ↔ ↔ 94 / 70 ↔ ↔ 48 / 21</p> <p>National Ave</p> <p>13 / 25 ↔ ↔ 50 / 111 ↔ ↔ 12 / 12 ↔ ↔</p> <p>7 / 13 ↔ ↔ 41 / 77 ↔ ↔ 16 / 30</p>



Legend
X / Y = AM / PM PEAK HOUR
TURNING VOLUMES



Barrio Logan Community Plan Update

<p>25</p> <p>↔ 22 / 15 ↔ 66 / 42 ↔ 3 / 5</p> <p>Sampson St</p> <p>↔ 8 / 6 ↔ 17 / 16 ↔ 2 / 0</p> <p>Newton Ave</p> <p>↔ 15 / 23 ↔ 20 / 25 ↔ 10 / 12</p> <p>↔ 4 / 6 ↔ 35 / 63 ↔ 7 / 3</p>	<p>26</p> <p>↔ 15 / 10 ↔ 59 / 27 ↔ 10 / 8</p> <p>Sampson St</p> <p>↔ 16 / 8 ↔ 115 / 44 ↔ 53 / 27</p> <p>Main St</p> <p>↔ 5 / 13 ↔ 33 / 82 ↔ 12 / 8</p> <p>↔ 14 / 5 ↔ 31 / 46 ↔ 35 / 49</p>	<p>27</p> <p>↔ 32 / 26 ↔ 75 / 66 ↔ 3 / 14</p> <p>Sampson St</p> <p>↔ 12 / 8 ↔ 517 / 198 ↔ 75 / 19</p> <p>Harbor Dr</p> <p>↔ 10 / 56 ↔ 234 / 748 ↔ 28 / 5</p> <p>↔ 14 / 23 ↔ 61 / 111 ↔ 38 / 41</p>	<p>28</p> <p>↔ 11 / 9 ↔ 18 / 14 ↔ 4 / 4</p> <p>Sicard St</p> <p>↔ 3 / 1 ↔ 155 / 124 ↔ 27 / 8</p> <p>National Ave</p> <p>↔ 4 / 10 ↔ 79 / 162 ↔ 7 / 8</p> <p>↔ 13 / 3 ↔ 25 / 25 ↔ 12 / 17</p>
<p>29</p> <p>↔ 1 / 2 ↔ 8 / 21 ↔ 43 / 77</p> <p>26th St</p> <p>↔ 48 / 54 ↔ 191 / 117 ↔ 36 / 35</p> <p>National Ave</p> <p>↔ 3 / 5 ↔ 66 / 155 ↔ 10 / 23</p> <p>↔ 7 / 14 ↔ 18 / 19 ↔ 15 / 34</p>	<p>30</p> <p>↔ 224 / 194 ↔ 42 / 31</p> <p>National Ave</p> <p>↔ 110 / 275 ↔ 4 / 10</p> <p>I-5 SB Off-ramp</p> <p>↔ 28 / 32 ↔ 149 / 296</p>	<p>31</p> <p>↔ 13 / 8 ↔ 11 / 6 ↔ 16 / 26</p> <p>26th St</p> <p>↔ 26 / 28 ↔ 148 / 45 ↔ 59 / 19</p> <p>Main St</p> <p>↔ 10 / 14 ↔ 50 / 167 ↔ 7 / 7</p> <p>↔ 11 / 2 ↔ 17 / 38 ↔ 39 / 80</p>	<p>32</p> <p>↔ 70 / 27 ↔ 12 / 4 ↔ 12 / 16</p> <p>Schley St</p> <p>↔ 17 / 39 ↔ 531 / 182</p> <p>Harbor Dr</p> <p>↔ 58 / 75 ↔ 200 / 712</p>
<p>33</p> <p>↔ 307 / 102 ↔ 166 / 210 ↔ 34 / 70</p> <p>28th St</p> <p>↔ 49 / 128 ↔ 422 / 327 ↔ 71 / 162</p> <p>National Ave</p> <p>↔ 106 / 94 ↔ 184 / 434 ↔ 18 / 85</p> <p>↔ 33 / 18 ↔ 83 / 98 ↔ 25 / 46</p>	<p>34</p> <p>↔ 31 / 28 ↔ 623 / 693 ↔ 122 / 245</p> <p>28th St</p> <p>↔ 64 / 43 ↔ 17 / 12 ↔ 8 / 7</p> <p>Boston Ave</p> <p>↔ 22 / 42 ↔ 50 / 131 ↔ 10 / 15</p> <p>↔ 9 / 7 ↔ 377 / 516 ↔ 90 / 203</p>	<p>35</p> <p>↔ 58 / 79 ↔ 565 / 487 ↔ 211 / 294</p> <p>28th St</p> <p>↔ 147 / 238 ↔ 245 / 121 ↔ 49 / 78</p> <p>Main St</p> <p>↔ 58 / 174 ↔ 88 / 360 ↔ 24 / 19</p> <p>↔ 19 / 23 ↔ 163 / 607 ↔ 37 / 140</p>	<p>36</p> <p>↔ 22 / 13 ↔ 15 / 12 ↔ 333 / 480</p> <p>28th St</p> <p>↔ 115 / 221 ↔ 372 / 202 ↔ 13 / 8</p> <p>Harbor Dr</p> <p>↔ 56 / 156 ↔ 225 / 543 ↔ 2 / 1</p> <p>↔ 0 / 1 ↔ 5 / 133 ↔ 1 / 0</p>

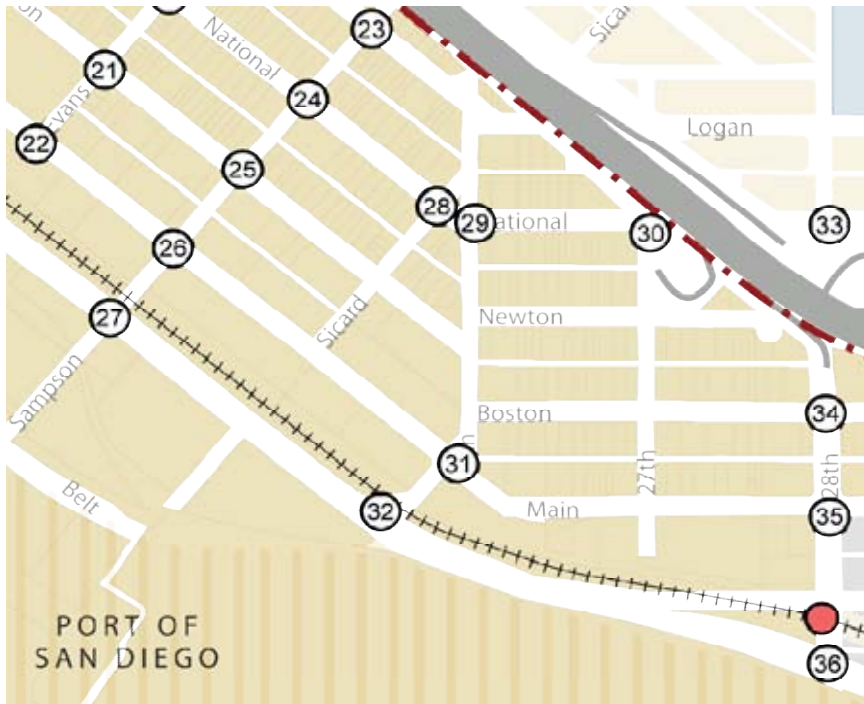

Legend
X / Y = AM / PM PEAK HOUR
TURNING VOLUMES



K:\SND_TPTO\095707000\Excel\707000TA01.xlsx\Ex Figure 25-36

Barrio Logan Community Plan Update

<p>37</p> <p>29th St</p> <p>↔ 40 / 58 ↔ 57 / 46 ↔ 6 / 5</p> <p>Boston Ave</p> <p>↔ 224 / 495 ↔ 40 / 59 ↔ 7 / 14</p> <p>↔ 4 / 6 ↔ 20 / 49 ↔ 5 / 13</p>	<p>38</p> <p>↔ 12 / 27 ↔ 83 / 61 ↔ 39 / 123</p> <p>32nd St</p> <p>↔ 74 / 98 ↔ 317 / 241 ↔ 314 / 207</p> <p>Main St</p> <p>↔ 9 / 24 ↔ 103 / 462 ↔ 158 / 136</p> <p>↔ 110 / 183 ↔ 50 / 112 ↔ 26 / 307</p>	<p>39</p> <p>↔ 12 / 29 ↔ 161 / 231 ↔ 191 / 242 ↔ 19 / 24</p> <p>32nd St</p> <p>↔ 36 / 63 ↔ 9 / 71 ↔ 29 / 41 ↔ 24 / 37</p> <p>↔ 78 / 112 ↔ 164 / 291 ↔ 65 / 420 ↔ 216 / 204</p> <p>↔ 21 / 46 ↔ 23 / 76 ↔ 423 / 265 ↔ 12 / 2</p> <p>Wabash Blvd</p> <p>↔ 47 / 172 ↔ 112 / 127 ↔ 11 / 41 ↔ 244 / 120</p>	<p>40</p> <p>↔ 136 / 180 ↔ 739 / 200 ↔ 89 / 219</p> <p>32nd St</p> <p>↔ 276 / 321 ↔ 316 / 267 ↔ 207 / 26</p> <p>Harbor Dr</p> <p>↔ 94 / 239 ↔ 141 / 796 ↔ 99 / 64</p> <p>↔ 20 / 48 ↔ 105 / 487 ↔ 19 / 97</p>
<p>41</p> <p>↔ 268 / 126 ↔ 108 / 120</p> <p>I-15 Ramps</p> <p>↔ 107 / 154 ↔ 390 / 275</p> <p>Main St</p> <p>↔ 36 / 254 ↔ 139 / 579</p>			



Legend
X / Y = AM / PM PEAK HOUR
TURNING VOLUMES



NOT TO SCALE



THIS MAP IS PROVIDED WITHOUT WARRANTY OF ANY KIND, EITHER EXPRESS OR IMPLIED, INCLUDING BUT NOT LIMITED TO, THE IMPLIED WARRANTIES OF MERCHANTABILITY AND FITNESS, FOR A PARTICULAR PURPOSE. Copyright SanGIS. All Rights Reserved. This product may contain information from the SANDAG Regional Information System which cannot be reproduced without written permission of SANDAG. This product may contain information which has been reproduced with permission granted by Thomas Bros. Maps.

- LEGEND**
- Barrio Logan Community Plan Area
 - City Boundary
 - Freeway/Ramp
 - SDMTS Trolley and Station
 - Park/Open Space
 - School
 - Port District
 - Naval Station San Diego

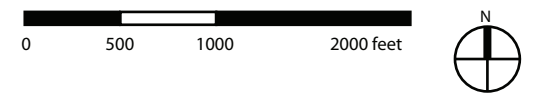

Figure 3-4: Existing ADT Volumes
Barrio Logan Community Plan Update



Intersection Analysis

Table 3-3 displays the LOS analysis results for the study intersections under Existing Conditions. As shown in the table, all intersections currently operate at LOS D or better during both peak periods, except for the following intersection:

- Boston Avenue & I-5 SB On-Ramp (LOS F – p.m. peak)

The movement that operates at LOS F is the northbound movement, which is stop controlled. In the afternoon peak, the majority of the vehicles traveling through the intersection are making a left-turn onto the I-5 Southbound Ramp from Boston Avenue and the vehicles in the northbound approach need to find a gap to turn onto Boston Avenue or continue across the intersection.

In addition to the level of service results based on intersection delay, a queuing analysis found that the following intersections have movements that may exceed the available storage capacity with a 95th percentile level of traffic volumes:

- Kearney Street & Cesar Chavez Parkway (Westbound movements - a.m. peak);
- Logan Avenue & Cesar Chavez Parkway (Southbound left-turn movement - p.m. peak);
- Harbor Drive & Cesar Chavez Parkway (Eastbound left-turn movement - a.m. and p.m. peak);
- Boston Avenue & 28th Street (Southbound left-turn movement- a.m. and p.m. peaks);
- Main Street & 28th Street (Southbound left-turn movement- a.m. and p.m. peaks);
- Harbor Drive & 28th Street (Eastbound left-turn movement- a.m. and p.m. peaks);
- Main Street & 32nd Street (Westbound left-turn and Northbound left-turn movements - a.m. and p.m. peaks); and
- Main Street & I-15 Ramps (Eastbound left-turn movement - p.m. peaks)

Based on Synchro 6.0 queuing report, none of the above listed intersections would have queuing interactions that would affect the LOS and/or capacity of the intersections.

Appendix D contains the LOS calculation worksheets.

Roadway Segment Analysis

Table 3-4 displays the roadway segments analysis under Existing Conditions. As shown in the table, based on planning level analysis and on ADT volumes, it is estimated that all roadway segments function at an acceptable LOS in the study area, except for the following segments:

- 28th Street between I-5 and Boston Avenue (LOS E)
- 32nd Street between Main Street and Wabash Boulevard (LOS E)
- National Avenue between Sicard Street and 27th Street (LOS F)
- Boston Avenue between 28th Street and 32nd Street (LOS F)
- Main Street between 32nd Street and Rigel Street (LOS F)
- Main Street between Rigel Street and Una Street (LOS F)
- Main Street between Una Street and I-5 SB Off-Ramp (LOS F)

The roadway segment analysis used in this study is based on theoretical capacities based on the number of travel lanes. The analysis does not take into account other physical features that can affect the capacity of a roadway segment like grades, number of traffic signals, number of driveways, parking availability, etc.

In addition, the analysis does not take into account the different traffic peak periods experienced on these roadways due to the surrounding land uses. As an example, the Barrio Logan traffic patterns are unique in that they are heavily influenced by the Port of San Diego and the Navy Base traffic generators who peak-hour of use do not correspond to typical peak-hour commuter traffic. Therefore, the typical planning level capacity for these streets may understate the carrying capacity of these roadways. To better represent the conditions of a roadway segment within the Barrio Logan community, the operations of the upstream and downstream intersections of each respective segment during the peak periods would indicate whether the roadway segment would have adequate capacity. As shown in the intersection analysis tables, all intersections along the failing roadway segments would operate at acceptable LOS.

Freeway Segment Analysis

Table 3-5 displays the freeway segments analysis under Existing Conditions. As shown in the table, it is estimated that all freeway segments function at an acceptable LOS in the study area, except for the segment of Interstate 5 between Interstate 15 and Division Street which operates at LOS E during the morning peak-hour period.

**TABLE 3-3
EXISTING CONDITIONS
PEAK-HOUR INTERSECTION LOS SUMMARY**

INTERSECTION	TRAFFIC CONTROL	PEAK HOUR	EXISTING	
			DELAY (a)	LOS (b)
1 Commercial St & 16th St	Signal	AM	19.4	B
		PM	24.6	C
2 National Ave & 16th St	Two-Way Stop	AM	11.7	B
		PM	12.5	B
3 National Ave & Sigsbee St	Signal	AM	9.6	A
		PM	9.6	A
4 Newton Ave & Sigsbee St	All-Way Stop	AM	7.9	A
		PM	7.6	A
5 Main St & Sigsbee St	All-Way Stop	AM	7.4	A
		PM	7.4	A
6 Harbor Dr & Sigsbee St	One-Way Stop	AM	17.0	C
		PM	18.1	C
7 Logan Ave & Beardsley St- I-5 SB ramp	All-Way Stop	AM	11.1	B
		PM	11.9	B
8 National Ave & Beardsley St	All-Way Stop	AM	8.5	A
		PM	8.7	A
9 Newton Ave & Beardsley St	All-Way Stop	AM	8.5	A
		PM	8.2	A
10 Main St & Beardsley St	All-Way Stop	AM	8.5	A
		PM	7.8	A
11 Harbor Dr & Beardsley St	One-Way Stop	AM	20.3	C
		PM	18.3	C
12 Kearney St & Cesar E. Chavez Pkwy	Signal	AM	21.7	C
		PM	21.2	C
13 Logan Ave & Cesar E. Chavez Pkwy	Signal	AM	14.0	B
		PM	13.0	B
14 National Ave & Cesar E. Chavez Pkwy	Signal	AM	11.0	B
		PM	14.0	B
15 Newton Ave & Cesar E. Chavez Pkwy	Signal	AM	8.1	A
		PM	9.1	A
16 Main St & Cesar E. Chavez Pkwy	Signal	AM	9.6	A
		PM	8.7	A
17 Harbor Dr & Cesar E. Chavez Pkwy	Signal	AM	33.2	C
		PM	43.6	D
18 Logan Ave & I-5 SB On-ramp	One-Way Stop	AM	8.8	A
		PM	9.9	A
19 National Ave & SR-75 Off-ramp	One-Way Stop	AM	10.1	B
		PM	11.0	B
20 National Ave & Evans St	Two-Way Stop	AM	11.2	B
		PM	11.9	B

Notes:

(a) Delay refers to the average control delay for the entire intersection, measured in seconds per vehicle. At a two-way stop-controlled intersection, delay refers to the worst movement.

(b) LOS calculations are based on the methodology outlined in the 2000 Highway Capacity Manual and performed using Synchro 6.0

(c) Delay calculations based on SimTraffic 6.0 microsimulation. These intersections were analyzed with SimTraffic to account for interaction with the trolley

K:\SND_TPTO\095707000\Excel\707000IN01.xlsm\Existing

**TABLE 3-3
EXISTING CONDITIONS
PEAK-HOUR INTERSECTION LOS SUMMARY (cont.)**

INTERSECTION	TRAFFIC CONTROL	PEAK HOUR	EXISTING	
			DELAY (a)	LOS (b)
21 Newton Ave & Evans St	Two-Way Stop	AM	9.8	A
		PM	9.8	A
22 Main St & Evans St	One-Way Stop	AM	9.3	A
		PM	9.6	A
23 Logan Ave & Sampson St	All-Way Stop	AM	10.0	B
		PM	10.7	B
24 National Ave & Sampson St	Signal	AM	10.3	B
		PM	9.4	A
25 Newton Ave & Sampson St	All-Way Stop	AM	7.5	A
		PM	7.6	A
26 Main St & Sampson St	All-Way Stop	AM	8.6	A
		PM	8.2	A
27 Harbor Dr & Sampson St	Signal	AM	23.1	C
		PM	27.1	C
28 National Ave & Sicard St	Two-Way Stop	AM	12.0	B
		PM	11.4	B
29 National Ave & 26th St	All-Way Stop	AM	8.7	A
		PM	8.8	A
30 National Ave & I-5 SB Off-ramp	One-Way Stop	AM	11.5	B
		PM	17.8	C
31 Main St & 26th St-Schley St	All-Way Stop	AM	7.7	A
		PM	8.0	A
32 Harbor Dr & Schley St	Signal	AM	19.6	B
		PM	14.1	B
33 National Ave & 28th St	Signal	AM	35.3	D
		PM	29.8	C
34 Boston Ave & 28th St	Signal	AM	10.6	B
		PM	17.7	B
35 Main St & 28th St	Signal	AM	23.4	C
		PM	29.2	C
36 Harbor Dr & 28th St	Signal	AM	34.3	C
		PM	45.6	D
37 Boston Ave & I-5 SB On-ramp-29th St	One-Way Stop	AM	17.3	C
		PM	260.7	F
38 Main St & 32nd St	Signal	AM	21.9	C
		PM	29.2	C
39 32nd St & Wabash St	Signal	AM	38.5	D
		PM	32.0	C
40 Harbor Dr & 32nd St	Signal	AM	31.7	C
		PM	51.1	D
41 Main St & I-15 Ramps	Signal	AM	10.8	B
		PM	11.5	B

Notes:

Bold values indicate intersections operating at LOS E or F.

(a) Delay refers to the average control delay for the entire intersection, measured in seconds per vehicle. At a two-way stop-controlled intersection, delay refers to the worst movement.

(b) LOS calculations are based on the methodology outlined in the 2000 *Highway Capacity Manual* and performed using Synchro 6.0

(c) Delay calculations based on SimTraffic 6.0 microsimulation. These intersections were analyzed with SimTraffic to account for interaction with the trolley

K:\SND_TPTO\095707000\Excel\707000IN01.xlsm\Existing

**TABLE 3-4
EXISTING CONDITIONS
ROADWAY SEGMENT LOS SUMMARY**

ROADWAY SEGMENT	ROADWAY CLASSIFICATION (a)	LOS E CAPACITY	ADT (b)	V/C RATIO (c)	LOS
Cesar Chavez Pkwy					
north of Logan Ave	3 Lane Collector (with TWLT)	22,500	14,170	0.63	C
between Logan Ave and National Ave	4 Lane Collector (with TWLT)	30,000	15,300	0.51	C
between National Ave and Newton Ave	3 Lane Collector (with TWLT)	22,500	12,494	0.56	C
between Newton Ave and Main St	3 Lane Collector (with TWLT)	22,500	11,812	0.53	C
between Main St and Harbor Dr	4 Lane Collector (with TWLT)	30,000	10,381	0.35	B
Sampson St					
between I-5 and National Ave	2 Lane Collector (No TWLT)	8,000	3,086	0.39	B
between National Ave and Harbor Dr	2 Lane Collector (No TWLT)	8,000	2,561	0.32	B
26th St					
between National Ave and Main St	2 Lane Collector (No TWLT)	8,000	2,380	0.30	A
28th St					
between I-5 and Boston Ave	3 Lane Collector (with TWLT)	22,500	22,000	0.98	E
between Boston Ave and Main St	4 Lane Collector (with TWLT)	30,000	18,856	0.63	C
between Main St and Harbor Dr	4 Lane Major Arterial	40,000	16,658	0.42	B
32nd St					
between Main St and Wabash Blvd	2 Lane Collector (with TWLT)	15,000	13,172	0.88	E
between Wabash Blvd and Harbor Drive	4 Lane Major Arterial	40,000	19,785	0.50	B
Rigel St					
between Main St and I-5	2 Lane Collector (No TWLT)	8,000	1,723	0.22	A
Vesta St					
between Main St and I-5	2 Lane Collector (No TWLT)	8,000	4,900	0.61	C
Logan Ave					
between 17th St and Sigsbee St	2 Lane Collector (with TWLT)	15,000	3,659	0.24	A
between Sigsbee St and Cesar Chavez Pkwy	2 Lane Collector (with TWLT)	15,000	7,478	0.50	C
between Cesar Chavez Pkwy and 26th St	2 Lane Collector (with TWLT)	15,000	2,954	0.20	A
National Ave					
between 16th St and Sigsbee St	2 Lane Collector (with TWLT)	15,000	2,603	0.17	A
between Sigsbee St and Beardsley St	2 Lane Collector (with TWLT)	15,000	4,500	0.30	A
between Beardsley St and Cesar Chavez Pkwy	2 Lane Collector (No TWLT)	8,000	3,511	0.44	C
between Cesar Chavez Pkwy and Evans St	2 Lane Collector (No TWLT)	8,000	4,643	0.58	C
between Evans St and Sicard St	2 Lane Collector (with TWLT)	15,000	3,677	0.25	A
between Sicard St and 27th St	2 Lane Collector (No TWLT)	8,000	8,445	1.06	F
Boston Ave					
between 28th St and 32th St	2 Lane Collector (No TWLT)	8,000	2,420	0.30	A
Main St					
between Beardsley St and Cesar Chavez Pkwy	2 Lane Collector (No TWLT)	8,000	3,566	0.45	C
between Cesar Chavez Pkwy and 26th St	2 Lane Collector (No TWLT)	8,000	2,598	0.33	B
between 26th St and 28th St	3 Lane Collector (No TWLT)	11,250	7,435	0.66	C
between 28th St and 32nd St	3 Lane Collector (No TWLT)	11,250	11,266	1.00	F
between 32nd St and Rigel St	4 Lane Collector (No TWLT)	15,000	21,100	1.41	F
between Rigel St and Una St	2 Lane Collector (with TWLT)	15,000	15,944	1.06	F
between Una St and I-5 SB Off Ramp	2 Lane Collector (with TWLT)	15,000	15,177	1.01	F
Harbor Dr					
between Beardsley St and Cesar Chavez Pkwy	4 Lane Major Arterial	40,000	12,094	0.30	A
between Cesar Chavez Pkwy and Sampson St	4 Lane Major Arterial	40,000	13,778	0.34	A
between Sampson St and Schley St	4 Lane Major Arterial	40,000	9,080	0.23	A
between Schley St and 28th St	4 Lane Major Arterial	40,000	8,816	0.22	A
between 28th St and 32nd St	4 Lane Major Arterial	40,000	18,900	0.47	B
between 32nd St and Vesta St	4 Lane Major Arterial	40,000	16,320	0.41	B

Notes:

TWLT= Two-way left-turn lane (or centerlane)

Bold values indicate roadway segments operating at LOS E or F.

(a) Existing roadway classifications are based on field observations.

(b) Average Daily Traffic (ADT) volumes for the roadway segments were collected between 1999-2010.

(c) The v/c Ratio is calculated by dividing the ADT volume by each respective roadway segment's capacity.

K:\SND_TPTO\095707000\Excel\707000RS01.xlsm\Existing

**TABLE 3-5
EXISTING CONDITIONS
FREEWAY SEGMENT LOS SUMMARY**

FREEWAY SEGMENT	DIRECTION	NUMBER OF LANES	CAPACITY (a)	ADT (b)	PEAK-HOUR VOLUME (c)	V/C RATIO	LOS
AM PEAK							
I-5							
J Street to SR-75 Junction	NB	4 M	9,400	164,000	7,793	0.829	D
	SB	4 M	9,400				
SR-75 Junction to 28th Street	NB	4 M	9,400	160,000	7,603	0.809	D
	SB	4 M	9,400				
28th Street to I-15 Interchange	NB	4 M	9,400	154,000	7,317	0.778	C
	SB	4 M	9,400				
I-15 Interchange to Division St	NB	4 M	9,400	188,000	8,933	0.950	E
	SB	4 M	9,400				
I-15							
I-5 Interchange to Ocean View Blvd	NB	3 M	7,050	95,000			
	SB	3 M	7,050		4,722	0.670	C
SR-75 (d)							
I-5 Interchange to Glorietta Blvd	WB	2 M	4,700	73,000			
	EB	3 M	7,050		4,629	0.657	C
PM PEAK							
I-5							
J Street to SR-75 Junction	NB	4 M	9,400	164,000			
	SB	4 M	9,400		7,036	0.749	C
SR-75 Junction to 28th Street	NB	4 M	9,400	160,000			
	SB	4 M	9,400		6,865	0.730	C
28th Street to I-15 Interchange	NB	4 M	9,400	154,000			
	SB	4 M	9,400		6,607	0.703	C
I-15 Interchange to Division St	NB	4 M	9,400	188,000			
	SB	4 M	9,400		8,066	0.858	D
I-15							
I-5 Interchange to Ocean View Blvd	NB	3 M	7,050	95,000	5,216	0.740	C
	SB	3 M	7,050				
SR-75 (d)							
I-5 Interchange to Glorietta Blvd	WB	3 M	7,050	73,000	4,585	0.650	C
	EB	2 M	4,700				

Notes:

Bold values indicate freeway segments operating at LOS E or F.

M=Main Lane; A= Auxiliary Lane.

This analysis evaluates the higher peak-hour direction of traffic

(a) The capacity is calculated as 2,350 ADT per main lane and 1,200 ADT per auxiliary lane

(b) Traffic volumes provided by Caltrans

(c) Peak-hour volume calculated by: (ADT*K*D)/Truck Factor

(d) SR-75 has reversible lanes.

K:\SND_TPTO\095707000\Excel\707000FR01.xls\Existing

Parking

On-street

Parking has been a major issue and concern in Barrio Logan for decades. The community parking shortage is largely due to there not being enough parking provided on-site for workers at Harbor-related industries. The community and the city have undertaken various measures to control where people park through the use of residential permit parking districts and time limited parking.

Three time periods were selected for data collection to capture a snapshot of on-street parking occupancy in the Barrio Logan community. The first time period selected was between 9:00 a.m. and 11:00 a.m. This time period captured the majority of the industrial and military uses as most of the employees would be at work during this time period. The second time period selected was between 12:00 p.m. and 2:00 p.m. and captured the peak retail/commercial parking demand. This time period is consistent with the data obtained from the *Barrio Logan Parking Study*, dated April 20, 1999 and prepared by Linscott, Law & Greenspan Engineers. The third time period selected was between 7:00 p.m. and 9:00 p.m. and captured the peak residential uses as most people would be home during this time period.

An inventory of all on-street parking spaces was conducted in June 2008 and counted a total of 2,842 on-street parking spaces for the entire Barrio Logan community. Of the 2,842 parking spaces, the majority of them (2,325 spaces, 82 percent) are unrestricted and available for the general public. The remaining parking spaces have some sort of restriction, such as time restrictions or residential permit parking.

The on-street parking occupancy data collection was conducted on Thursday, June 5, 2008. In order to show the different peaking characteristics in different parts of the community, the Barrio Logan community was separated into the following five areas, with the first zone in the northwest portion of the community and the last zone in the southeastern portion of the community. **Figure 3-5** graphically displays the five areas.

- **Area 1:** Generally bounded by I-5 to the north, Harbor Drive to the south, SR-75 to the east, and 16th Street to the west. Land uses generally include commercial and residential.
- **Area 2:** Generally bounded by I-5 to the north, Harbor Drive to the south, 26th Street to the east, and SR-75 to the west. Land uses generally include commercial and residential.
- **Area 3:** Generally bounded by I-5 to the north, Harbor Drive to the south, 28th Street to the east, and 26th Street to the west. Land uses generally include industrial and some residential.
- **Area 4:** Generally bounded by I-5 to the north, Main Street to the south, 32nd Street to the east, and 28th Street to the west. Land uses generally include residential with some commercial and industrial.
- **Area 5:** Generally bounded by I-5 to the north, Main Street to the south, Woden Street to the east, and 32nd Street to the west. Land uses generally include industrial and commercial.

Table 3-6 summarizes the results of the on-street parking occupancy survey. As shown in the table, parking spaces are classified by restriction or type. The majority, 82 percent, of on-street parking spaces in the Barrio Logan Community are spaces without any restrictions. The residential permit restriction is the most prevalent restriction and accounts for 9 percent of the parking spaces. Time limit and metered parking accounts for 5 percent of the on-street parking supply. Loading zones account for 3 percent of the spaces and the remaining 1 percent accounts for handicap parking spaces.

Appendix E contains a more detailed summary by each block face for the entire community.

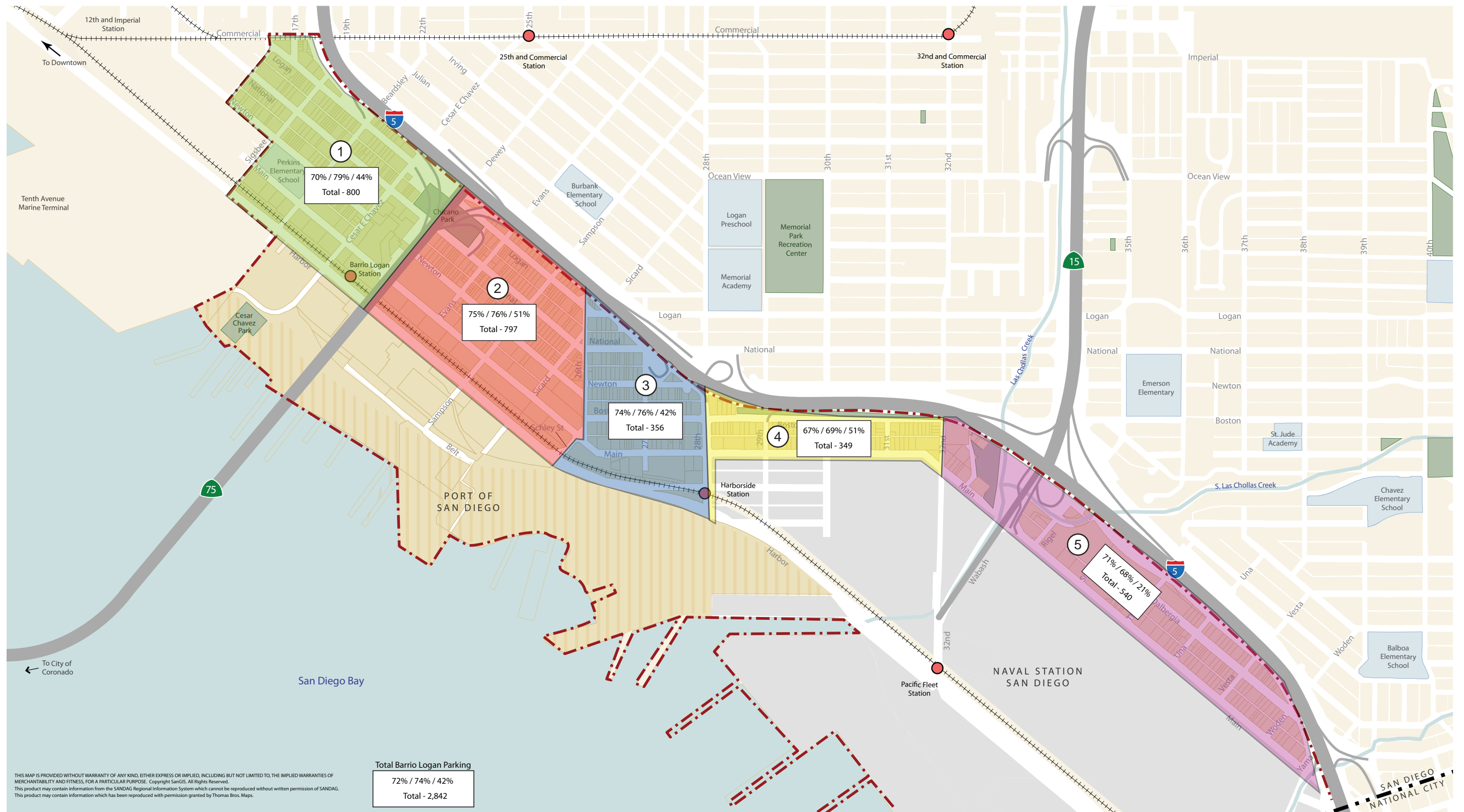

LEGEND

- Barrio Logan Community Plan Area
- City Boundary
- Freeway/Ramp
- SDMTS Trolley and Station
- Park/Open Space
- School
- Port District
- Naval Station San Diego

9:00AM/12:00PM/7:00PM
Total - XXX

Percentage of Occupied Parking Spaces
Total Available Parking Spaces

0 500 1000 2000 feet

**TABLE 3-6
EXISTING CONDITIONS
ON-STREET PARKING SUMMARY**

AREA	Time Limit			Residential PERMIT	LOADING ZONE	METERED	HANDI-CAP	REMAINING SPACES	TOTAL SPACES
	15 MIN.	30 MIN.	2 HR.						
Zone 1	7	7	5	--	21	--	6	755	800
Zone 2	11	10	37	146	26	--	7	560	797
Zone 3	5	7	16	71	22	17	3	215	356
Zone 4	--	4	--	41	10	10	5	279	349
Zone 5	3	5	--	--	14	--	2	516	540
TOTAL	26	33	58	258	93	27	23	2,325	2,842
Percentage (a)	1%	1%	2%	9%	3%	1%	1%	82%	--

Notes:

Parking inventory taken on June 05, 2008.

K:\TPTO\095707000\Data\Parking Data\[Parking Occupancy Data Collection.xls]Parking Table

Offsite/Off-street

Several off-street parking areas in Barrio Logan were observed to be used by two major port tenants, NASSCO and BAE Systems. These lots are depicted on **Figure 3-6** and occur either in privately owned lots or in railroad right-of-way located north of Harbor Drive. **Table 3-7** provides a summary of the parking supply and description of each of these parking areas. Over 2,600 parking spaces are located in these lots, which were observed to be full or nearly full during working hours.

**TABLE 3-7
EXISTING CONDITIONS
OFF-STREET PARKING SUMMARY**

LOCATION	DESCRIPTION	USER	TOTAL SPACES	
Harbor Dr between 32nd St , Chollas Creek and Railroad Tracks	Upper lot between Railroad and Navy base	NASSCO, owned by BN&SF Railroad	170	
	Lower lot accessed from Harbor Dr		70	
Harbor Dr between Chollas Creek and 28 th St	Upper lot between Railroad and Navy Base		280	
	Middle lot between freight and trolley tracks		390	
	Lower lot access from Harbor Dr		280	
Harbor Dr between 28 th St and Schley St	Upper lot between freight tracks and Harbor Dr		240	
	Lower lot between freight tracks and Harbor Drive		100	
Harbor Dr between Schley St and Sampson St	Lot between trolley tracks and Harbor Dr, access is from Schley St and Harbor Dr		100	
Main St between Sampson St, Schley St and trolley tracks	Privately owned lot		BAE Systems	780
Main St east of Schley St and north of trolley tracks	Privately owned lot		NASSCO	180
Boston Ave west of 29 th St and south of I-5	Privately owned lot	NASSCO	70	
TOTAL			2,660	

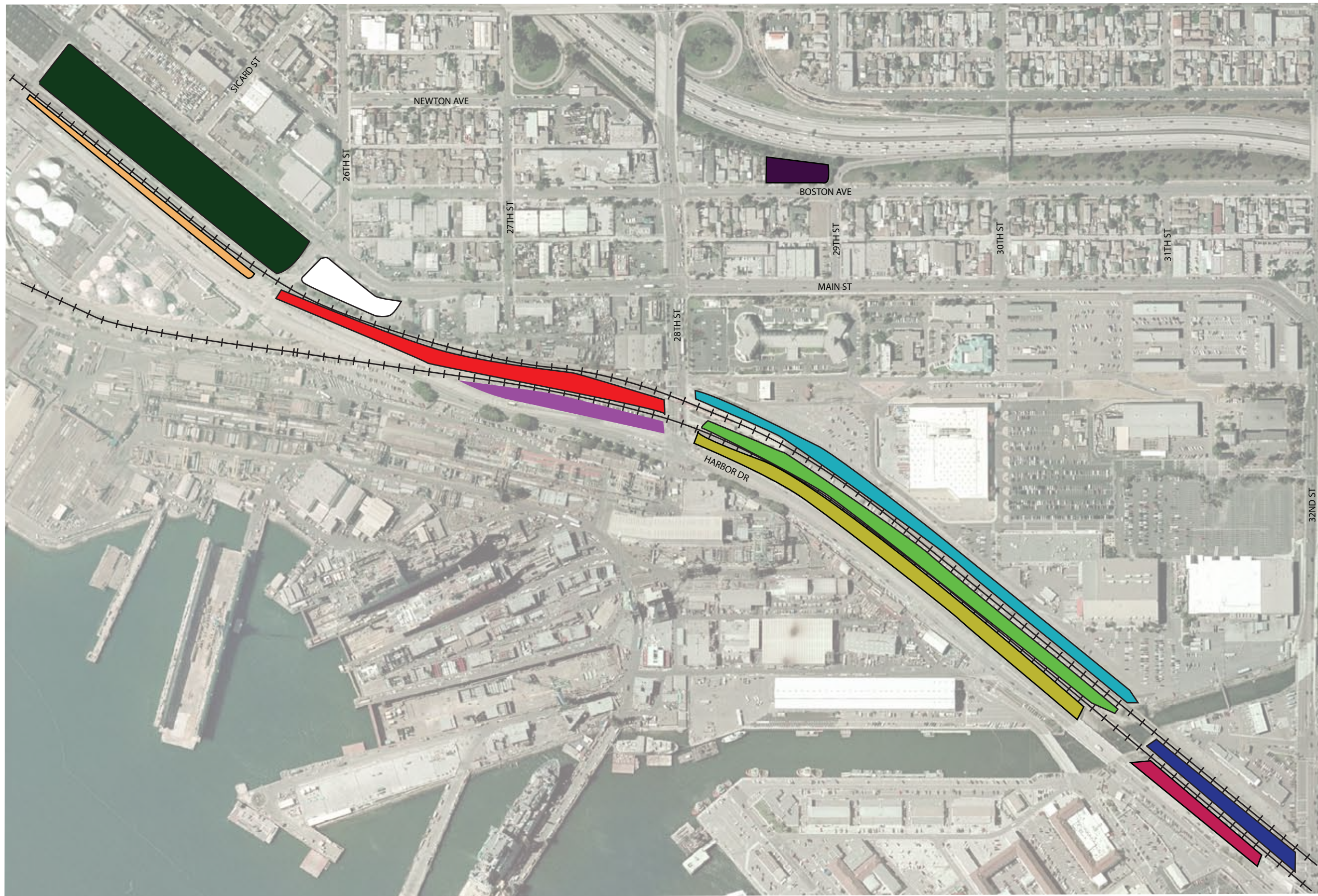

LEGEND











- | | | | |
|---|--|--|--|
|  170 parking spaces |  390 parking spaces |  100 parking spaces |  180 parking spaces |
|  70 parking spaces |  280 parking spaces |  100 parking spaces |  70 parking spaces |
|  280 parking spaces |  240 parking spaces |  780 parking spaces | |

Figure 3-6: Off-Site/Off-Street Parking

Truck Traffic

Within certain areas in the Barrio Logan community, trucks comprise a high percentage of the vehicular traffic on the roadways. Based on data obtained in October 2003 and provided in the *Barrio Logan Truck Study*, dated May 4, 2004 (Willdan), approximately 32 percent of the vehicles on Cesar Chavez Parkway south of Harbor Drive consisted of trucks. The large percentage was due to the Tenth Avenue Marine Terminal that requires trucks to transport goods to/from the terminal to the rest of the region. Along Cesar Chavez Parkway between Harbor Drive and I-5, the truck percentage ranged between 16 and 18 percent of the total traffic volume on the street. Along Harbor Drive, the percentage of truck traffic decreased from approximately 10 percent near Cesar Chavez Parkway to approximately seven percent near 32nd Street.

However, since the time that the study was completed, truck restrictions on various roadways in the community (as described under the Roadway Network section) have been implemented, and trucks to/from the Tenth Avenue Marine Terminal over five tons are required to use 28th Street to access I-5.

Vehicle classification counts were obtained on June 11 and 12, 2008 along Cesar Chavez Parkway between National Avenue and Newton Avenue. The average of the two days of data indicated that on a daily basis, 13 percent of the total vehicles along this segment are trucks. Although there has been a decline in truck traffic along Cesar Chavez Parkway, it appears that the truck restrictions along Cesar Chavez Parkway are not effective and field observations have verified that trucks are still present on this roadway.

Additional truck counts were collected during the morning and afternoon peak-hours along the Harbor Drive intersections between Cesar Chavez Parkway and Schley Street. These counts were collected in June and July 2009. The purpose of the counts was to estimate the existing truck distribution for the port industrial sites. The counts indicated that the majority of truck traffic uses Schley Street and Main Street to access the I-5 ramps at 28th Street and Boston Avenue. **Appendix F** contains copies of the truck count data.

Truck Restrictions

Based on the recommendation outlined in the *Barrio Logan Truck Study*, dated May 4, 2004 (Willdan), trucks over five tons are currently restricted along Cesar Chavez Parkway between I-5 and Harbor Drive. For the trucks accessing the Tenth Avenue Marine Terminal from I-5, the truck route is via 28th Street and Harbor Drive. As shown in **Figure 3-7** below, a sign indicating the truck route is placed on the south leg of the Cesar Chavez Parkway/Harbor Drive intersection.

However, based on field observations, trucks in excess of five tons are still using Cesar Chavez Parkway and Main Street via Sampson Street and Schley Street to access I-5. Trucks using Main Street to/from I-5 are avoiding the 28th Street/Harbor Drive intersection due to the geometric deficiencies (tight turns for large vehicles) and traffic congestion.

Figure 3-7 Truck Route Sign for Trucks Destined to I-5



An inventory of all existing truck restriction signs within the Barrio Logan community was completed in May 2008. Two types of truck restriction signs are present. The first type is a sign restricting trucks that weigh over one ton. All of these signs are located along Beardsley Street between Logan Avenue and Newton Avenue and along Newton Avenue between Sigsbee Street and Beardsley Street.

The second type is a sign restricting trucks that weigh over five tons. These signs are generally located in the area between Cesar Chavez Parkway and 27th Street, along the following street segments:

- Cesar Chavez Parkway between I-5 and Harbor Drive
- Evans Street between Logan Avenue and Main Street
- Sampson Street between Logan Avenue and Main Street
- Sicard Street between Logan Avenue and Main Street
- 26th Street between Logan Avenue and Main Street
- 27th Street between Newton Avenue and Main Street

Figure 3-8 shows examples of several truck restriction signs that are found in the community. It should be noted that truck restrictions do not apply to delivery trucks needing to access facilities located within the community. **Figure 3-9** graphically displays the truck routes and the truck restrictions in the Barrio Logan community.

Figure 3-8 Examples of Truck Restriction Signs





THIS MAP IS PROVIDED WITHOUT WARRANTY OF ANY KIND, EITHER EXPRESS OR IMPLIED, INCLUDING BUT NOT LIMITED TO, THE IMPLIED WARRANTIES OF MERCHANTABILITY AND FITNESS, FOR A PARTICULAR PURPOSE. Copyright SanGIS. All Rights Reserved.
 This product may contain information from the SANDAG Regional Information System which cannot be reproduced without written permission of SANDAG.
 This product may contain information which has been reproduced with permission granted by Thomas Bros. Maps.

LEGEND

- Barrio Logan Community Plan Area
- City Boundary
- Freeway/Ramp
- SDMTS Trolley and Station
- Park/Open Space
- School
- Port District
- Naval Station San Diego
- Truck Routes
- Truck Weight Limit Prohibition (5 tons)
- Truck Weight Limit Prohibition (1 tons)
- Truck Parking Restriction



Figure 3-9: Truck Routes and Restrictions