

CARMEL VALLEY

development
unit three
precise plan

CARMEL VALLEY
DEVELOPMENT UNIT THREE
PRECISE PLAN

Adopted by the City of San Diego:

November 24, 1981

Amended by the City of San Diego:

March 17, 1992

Prepared by:
Project Design Consultants
701 "B" Street, Suite 800
San Diego, CA 92101
(619) 235-6471

396.10
[280-02]

DEVELOPMENT UNIT THREE PRECISE PLAN

PREFACE

On October 22, 1981, the City Planning Commission of The City of San Diego unanimously approved the Development Unit Three Precise Plan within the **Carmel** Valley Community Plan by Resolution No. 3503. In addition the Commission considered and adopted the Environmental Impact Report (EQD #80-10-03) by Resolution No. 3505.

The City Council of The City of San Diego unanimously **adopted** the Development Unit Three Precise Plan on November 24, 1981, by Resolution No. 255421. By Resolution No. 255420 the Council also certified the information contained in the Environmental Impact Report for compliance with the California Environmental Quality Act of 1970. In addition the findings of the **EIR** were approved by Resolution No. **255422**. The Plan and EIR are on file in the office of the City Clerk.

On December 12, 1991, the Planning Commission adopted Resolution No. 0925 making recommendations to the City Council concerning an amendment to the Development Unit Three Precise Plan. By Resolution No. 279568, the City Council, on March 17, 1992, unanimously approved redesignation of a **3.3** acre parcel **from** Neighborhood Commercial to Attached Residential. The Council also certified that the information contained in the Mitigated Negative Declaration No. 91-0553 has been completed in compliance with **CEQA** and adopted a Mitigation, Monitoring and Reporting Program.

TABLE OF CONTENTS

	Page
Chapter 1	INTRODUCTION 1
1.1	Location of Precise Plan Area 2
1.2	Carmel Valley Community Plan 4
1.3	Significance of Precise Plan 6
1.4	Description of Precise Plan Area 8
Chapter 2	LAND USE ELEMENT 11
2.1	Land Use Summary 12
2.1a	Neighborhood Concept 12
2.1b	Statistical Summary 14
2.2	Residential Land Use 16
2.2a	Housing Mix 16
2.2b	Housing Location 16
2.2c	Balanced Community 19
2.3	Neighborhood Facilities 21
2.3a	Elementary School 21
2.3b	Neighborhood Park 21
2.4	Other Facilities and Services 24
2.5	Utilities 25
2.5a	Water 25
2.5b	Sewer 25
2.5c	Drainage 25
2.5d	Power 27
2.5e	Communications 27
2.6	Open Space 28
Chapter 3	CIRCULATION ELEMENT 31
3.1	Community-Wide Street System 32
3.2	Unit Street System 35
3.3	Alternative Transportation Modes 38
3.3a	Transit 38
3.3b	Bicycle Circulation 38
3.3c	Pedestrian Movement 40
3.4	Community and Unit Interface 41
3.5	Parking 43
3.6	Street Sections 44
Chapter 4	DESIGN ELEMENT 51
4.1	Design Objectives 52
4.2	Neighborhood Design Approach 53
4.3	Grading Concept 55
4.3a	Neighborhood Grading 55
4.3b	Project Grading 57
4.4	Drainage 60
4.4a	Neighborhood Drainage 60
4.4b	Project Drainage 61

	<u>Page</u>
Chapter 4	
4.5	Landscape Design 62
	4.5a Plant Selection 62
	4.5b Landscape Maintenance. 64
	4.5c Fencing. 64
4.6	Conservation Practices. 66
	4.6a Energy Conservation. 66
	4.6b Water Conservation. 67
	4.6c Natural Open Space Preservation 67
4.7	Community Interface. 68
	4.7a Perimeter Arterial Streets 68
	4.7b Neighborhood Entrances. 71
	4.7c Freeway Buffer. 73
	4.7d Northeastern Slope. 75
4.8	Collector Street Parkway. 77
	4.8a Parkway Design Treatment. 77
	4.8b Embellishment Features. 80
	4.8c Public View Overlook. 81
4.9	Detached Residential Projects. 85
	4.9a Development Regulations. 85
	4.9b Design Treatment. 86
	4.9c Conventional Lots. 86
	4.9d Theater Lots. 87
4.10	Attached Residential Project. 89
	4.10a Development Regulations. 89
	4.10b Design Treatment 90
	4.10c Project Types. 91
4.11	School and Park 92
	4.11a Elementary School. 92
	4.11b Neighborhood Park. 95
	4.11c Internal Bike/Pedestrian Path 97
4.12	Power Easement. 100
Chapter 5	IMPLEMENTATION ELEMENT. 103
5.1	Physical Development Controls. 104
5.2	Development Phasing. 108
	5.2a Residential Phasing. 108
	5.2b Provision of Facilities. 112
5.3	Public Facilities Financing. 113
Chapter 6	COMMUNITY PLAN CONFORMANCE 115
6.1	Carmel Valley Goals. 116
6.2	Precise Development Plan Criteria 118

TABLE OF FIGURES

		<u>Page</u>
Figure 1	Location Map	3
Figure 2	Community Plan	5
Figure 3	Plan Processing	7
Figure 4	Site Analysis	9
Figure 5	Land Use Plan	13
Figure 6	Residential Development	17
Figure 7	Neighborhood Facilities	22
Figure 8	Major Utilities	26
Figure 9	Open Space	29
Figure 10	Community Street System	33
Figure 11	Unit Street System	36
Figure 12	Alternate Transport	39
Figure 13	Community Ties	42
Figure 14	Perimeter Street Sections	45
Figure 15	Collector Street Sections	46-48
Figure 16	Local Street Sections	49
Figure 17	Unit Design Approach	54
Figure 18	Grading Concept	56
Figure 19	Off-Site Grading	58
Figure 20	Typical Arterial Treatment	69
Figure 21	Neighborhood Entrance	72
Figure 22	Freeway Buffer	74
Figure 23	Northeastern Slope	76
Figure 24	Collector Loop - Parkway Flat Condition	78
Figure 25	Collector Loop - Parkway Slope Condition	79
Figure 26	Collector Loop - Parkway Embellishment Feature	82
Figure 27	Collector Loop - Parkway View Overlook	83
Figure 28	Theater Lot Treatment	88
Figure 29	School Schematic	93
Figure 30	Preliminary Park Study Plan	96
Figure 31	Bike/Pedestrian Path	99
Figure 32	Power Easement Design	101
Figure 33	Proposed Zoning	105
Figure 34	Phasing Plan	109
Figure 35	Precise Plan Map	121

TABLE OF TABLES

		<u>Page</u>
Table 1	Land Use Acreage Allocations	15
Table 2	Housing Mix	18
Table 3	Neighborhood Open Space Preservation and Maintenance	30
Table 4	Recommended Tree List	63
Table 5	Physical Development Controls	106
Table 6	Projected Residential Development Phasing	111
Table 7	Carmel Valley Community Plan/Unit Three Precise Plan Comparisons	119

Chapter 1 INTRODUCTION

This chapter introduces Development Unit Three as a neighborhood unit within the new community of **Carmel** Valley. Preparation of the precise plan for the development unit is a requirement of the 1975 Carmel Valley **Community** Plan. A brief site analysis of the precise plan area is provided at the end of the chapter.

1.1 Location of Precise Plan Area

Development Unit Three is situated in the northwest corner of the Carmel Valley community planning area within the City of San Diego. It lies adjacent to Interstate 5, **immediately** north of the Del Mar Heights Road freeway interchange. Figure 1 depicts the location of the Unit Three precise plan area and the community.

Nearby communities include Del Mar to the west, Solana Beach and Rancho Santa Fe to the north, and La **Jolla** to the southwest. The Pacific Ocean lies approximately 1.25 miles to the west. Unit Three is situated just south of the City of San Diego-County of San Diego boundary, and the development area is located outside the California Coastal Zone. The San Dieguito River valley is situated immediately to the north of the precise plan area.

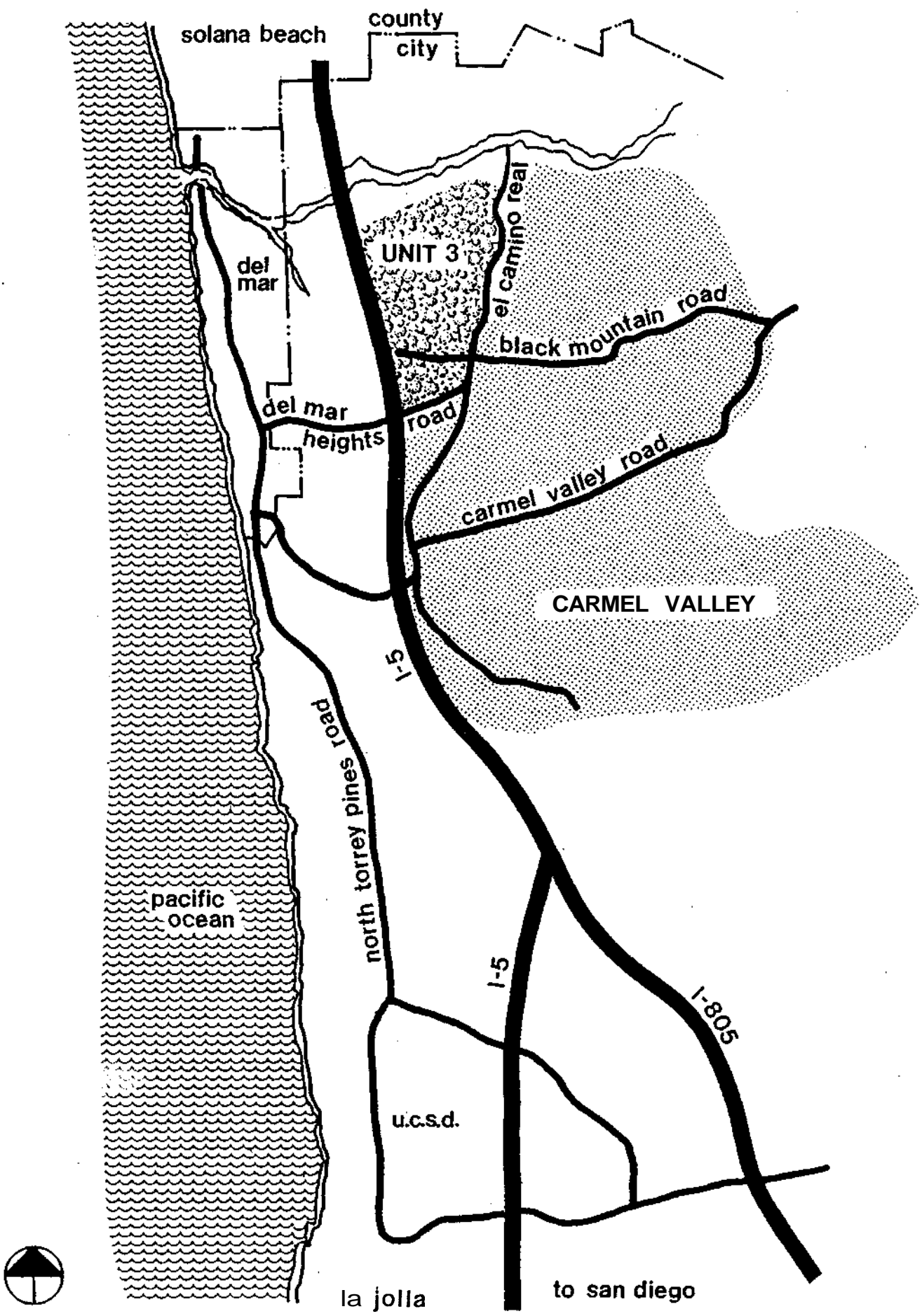

LOCATION MAP

1.2 Carmel Valley Community Plan

In 1975 the City of San Diego City Council adopted the Carmel Valley Community Plan. This plan calls for the orderly development of residential, **commercial/industrial,** and support uses on 4,286 acres of land, generating an estimated **40,200** population. Figure 2 illustrates the location of Development Unit Three within the Carmel Valley land use map.

The **Carmel** Valley Community Plan was prepared as a development guide for an entirely new community, based on City urbanization policies. The plan's proposals evolved from a series of environmental and feasibility studies, and preparation and review of several alternative community plans. A phased development program was incorporated into the plan in order to ensure adequate public facilities.

The five general goals stated in the community plan summarize the overall planning approach:

- "1. To establish a physical, social, and economically balanced community.
- "2. To establish self-containment and feeling of community identity among the future residents of Carmel Valley.
- "3. To preserve the natural environment.
- "4. To establish a balanced transportation system which is used as a tool for shaping the urban environment.
- "5. To establish realistic phasing of development within the community based on maximum utilization of the privately financed public **facilities.**"

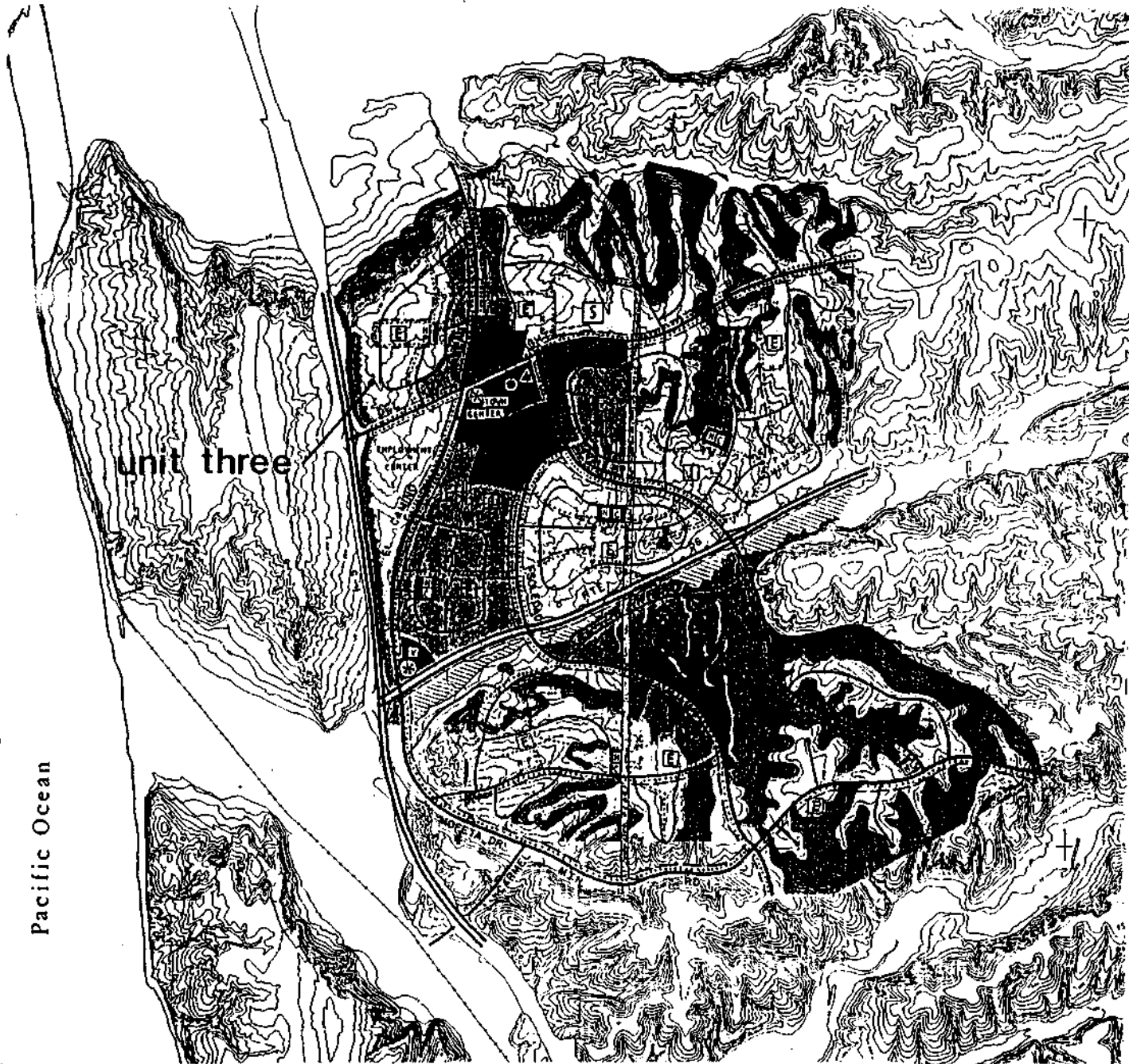

Pacific Ocean

RESIDENTIAL

- VERY LOW DEN. 5 DU/AC.
- LOW DEN. 10 DU/AC.
- LOW MED. DEN. 20 DU/AC.
- MEDIUM DEN. 40 DU/AC.

COMMERCIAL

- ALL CATEGORIES N-NEIGHBORHOOD V-VISITOR

PUBLIC FACILITIES

- SCHOOLS E-ELEM. J-JR. S-SR.
- P-PARK N-NEIGHBORHOOD C-COMM.
- LIBRARY ▲ FIRE STATION

TRANSPORTATION

- FREEWAY
- MAJOR STREET
- COLLECTOR STREET

- BICYCLE PATH
- PEDESTRIAN
- * TRANSPORTATION TERMINAL
- OPEN SPACE
- FLOOD PLAIN

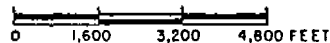

CARMEL VALLEY COMMUNITY PLAN

1.3 Significance of Precise Plan

The Carmel Valley Community Plan calls for the preparation of precise plans for the development units making up the **community**. The property owners within each development unit must arrive at a precise plan for **submittal** to the City for approval. Each precise plan is required to specify the detailed development proposals within the framework of concepts and guidelines provided by the community plan. The Unit Three precise plan area is designated as a precise plan development unit or "neighborhood" in the community plan.

The Unit Three precise plan was prepared and adopted in conformance with the community plan goals outlined in Section 1.2 above. In addition, the precise plan meets the precise development plan criteria for plan concepts and preparation set out in the community plan. For a discussion of precise plan conformance with the goals and criteria of the Carmel Valley Community Plan, see Chapter 6.

As illustrated in Figure 3, the Unit Three precise plan constitutes one step in a series of steps in City approval of development in Unit Three. While being based on the Carmel Valley Community Plan, the adopted precise plan itself becomes the basis for reviewing **subsequent** development plans, subdivisions, and other permits. Companion documents to the precise plan include the Unit Three Planned District Ordinance and the Unit Three Environmental Impact Report (**EIR**). The ordinance establishes the procedures and standards for the City review of the development **plans**, including special zoning. The EIR cites the existing conditions in the precise plan area, anticipated impacts of development under the precise plan, and mitigation measures.

Development Unit Three is the third precise plan to be prepared by private developers for consideration and adoption by the City. The first two units were Carmel Valley (Unit One) and the Employment Center (Unit **Two**). According to the phasing plans in the Carmel Valley Community Plan, Unit Three lies predominantly within Phase 1, with the northern portion in Phase 2 and the transitional area between Phases 1 and 2. The Planning Commission approved **commencement** of the Unit Three planning effort at a workshop on April 10, 1980. The Unit Three precise plan should provide guidance for development of the site through full build-out.

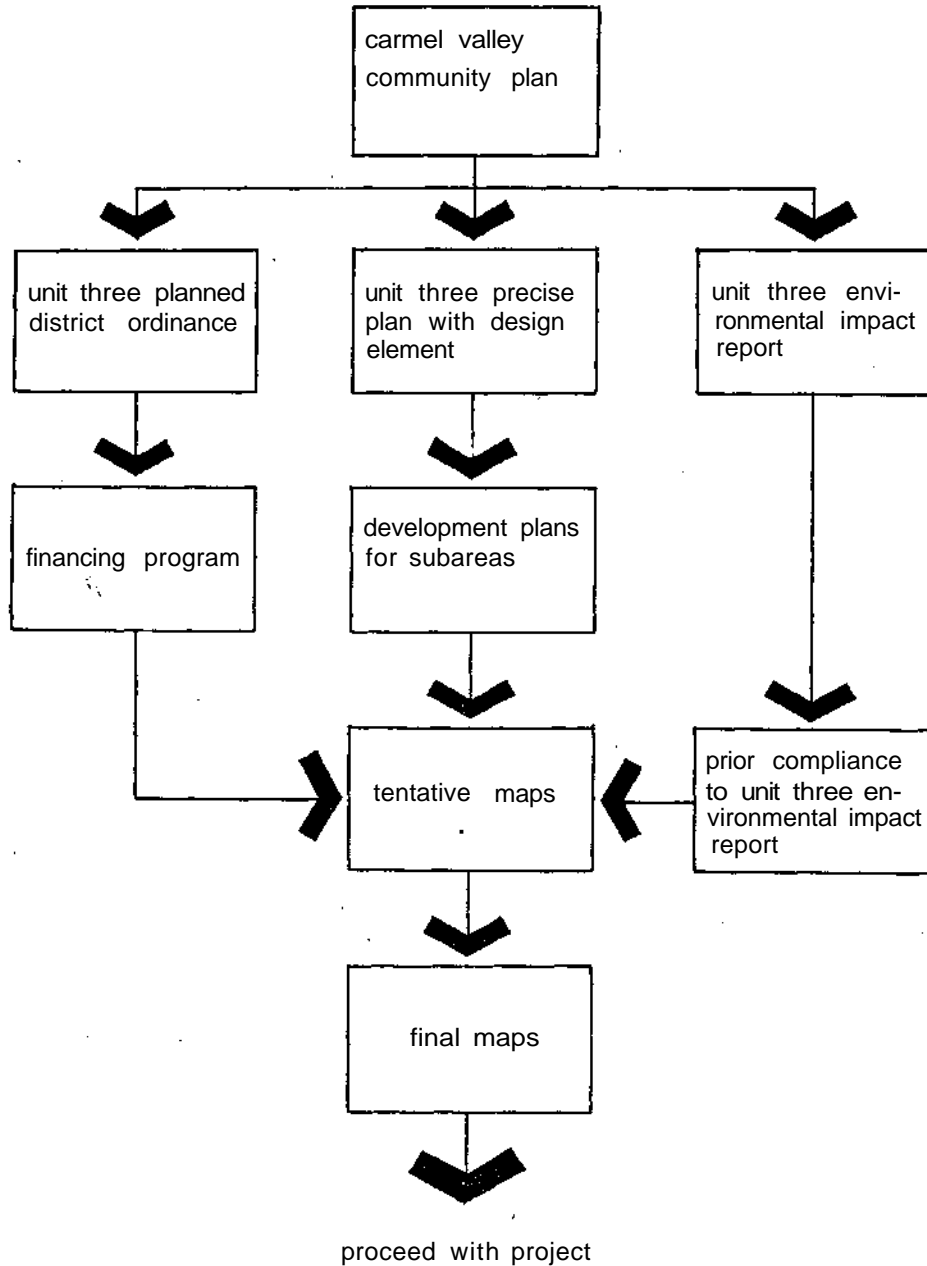

1.4 Description of Precise Plan Area

The Unit Three precise plan area encompasses 290 acres of land bounded by Interstate 5 and Del Mar to the west; cliffs falling off to the San Dieguito River valley to the north; El **Camino** Real to the east; and Del Mar Heights Road to the south. A power easement running north-south bisects the plan area, and an existing telephone facility is located in the southwest corner. The property has been the site of various residences in the past and is largely disturbed.

As depicted in Figure 4, the topography slopes upward from a broad drainage course on the eastern side of the plan area, culminating in a ridge. Sandstone bluffs unsuitable for development run along the northwest part of the plan area. A large area falling off northward toward the river valley is appropriate for open space and is so designated in the **Carmel** Valley Community Plan. There are several small areas characterized by steep slopes in the eastern half of the plan area.

On the east and south **sides**, the site sits above the perimeter roadways, with slopes along the streets up to the developable acreage; traffic noise is generated along these roads. Interstate 5 lies substantially below the plan area on the west side; **nevertheless**, the western and northwestern portions of the property are impacted by traffic noise from the freeway. The site is dotted with torrey pines and eucalyptus trees, some in stands.

The key feature of the plan area is the view opportunities. In the northern third of the site, dramatic views can be captured to the ocean and Del Mar Racetrack, and the river valley and hills beyond. The western **quarter** of the neighborhood looks across the freeway to the hillsides in Del Mar Heights. Broad vistas of the future Carmel Valley community and hills beyond are available from the central portion of the site.

In the context of the Carmel Valley community, the Unit Three precise plan area lies north of the proposed employment **center** and northwest of the proposed town center. A **residential** neighborhood is proposed to the east across El **Camino Real**.

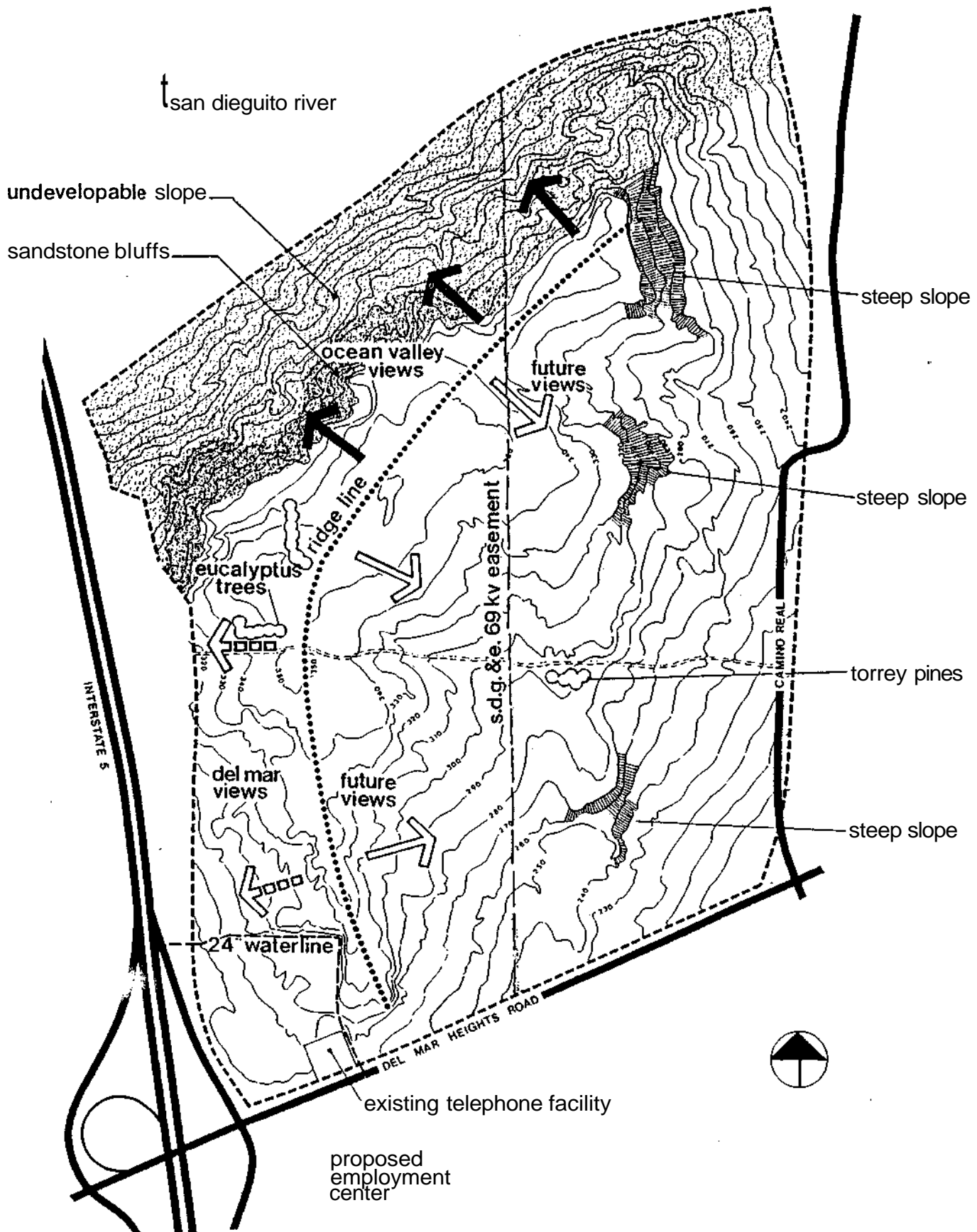

SITE ANALYSIS

Chapter 2 LAND USE ELEMENT

This chapter outlines the nature, location, and acreage of various land uses within Development Unit Three. A summary discussion is followed by proposals for each land use.

While the precise plan indicates specific site acreages and also residential densities and dwelling unit counts for each residential site, the site sizes, densities, and yields may be subject to minor modification during precise engineering and design. Such **modifications** may be necessary because of adjustments in street alignments, grading, and utility design during engineering of development plans and subdivision maps. **However, no substantial** deviations from this precise plan document are anticipated.

It should also be noted that the Land Use Element primarily provides a functional or "structural" description of the plan. The Design Element (Chapter 4) addresses the more qualitative aspects of design and development proposals.

2.1 Land Use Summary

2.1a Neighborhood Concept

The Carmel Valley Community Plan outlines a series of "neighborhood design concepts" to be incorporated in the design of residential precise plan areas. These concepts have been incorporated to the extent feasible in the Unit Three precise plan. The design concepts are based on the general goals of the community plan stated in Section **1.2.**

Below is a summary of the neighborhood design concepts as set out in the community plan:

- Locate the neighborhood center centrally in the neighborhood as the focus of a pedestrian and bike-way system.
- Link the perimeter major street system to a collector street loop within the neighborhood which will provide "**drive** by" access to the school.
- Connect a continuous pedestrian and bikeway system along the perimeter major streets to bike/pedestrian ways buffering the neighborhood center from adjacent **residential.**
- Minimize the conflict between vehicular traffic and the pedestrian and bikeway system.
- Plan both the neighborhood center and the surrounding neighborhood concurrently to ensure each relates to and complements the other.

The arrangement of land uses and circulation for Unit Three is illustrated in Figure 5. In general, this land use plan follows the overall design concept above. Variations from the concept arise from the characteristics of the site. The major features of the Unit Three plan are summarized below:

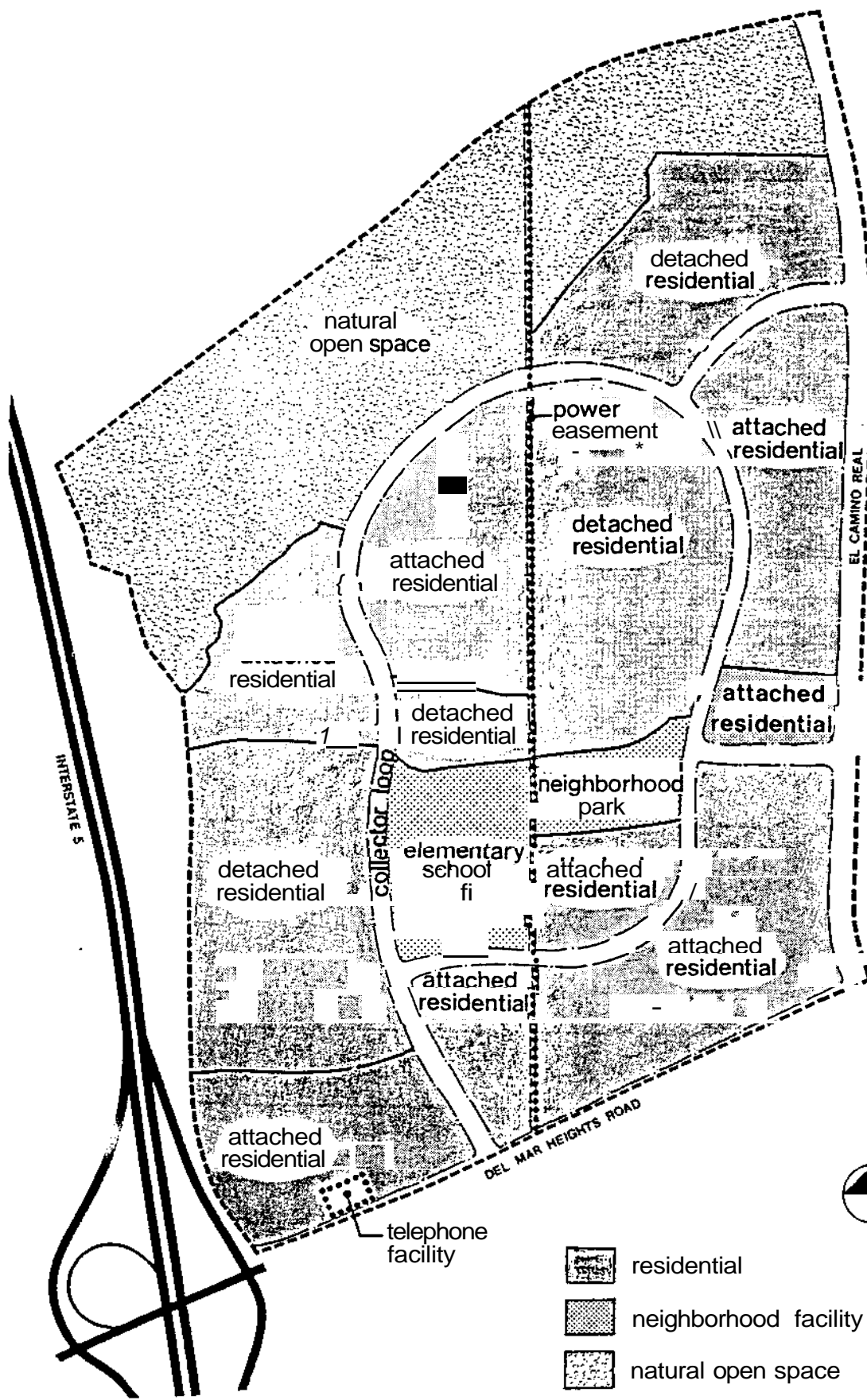

LAND USE PLAN

- Neighborhood facilities include an elementary school and **park**, which are located side by side.
- The neighborhood center facilities are centrally located and are linked by the pedestrian and bikeway **system**.
- Perimeter arterial streets bound the east and south sides of the precise plan area, with the freeway and difficult terrain on the west and north sides, respectively. The perimeter streets are tied to an internal collector loop providing access to neighborhood facilities and residential areas.
- The bikeway-pedestrian system includes the community-wide paths along the arterial streets, linked to neighborhood paths along the collector loop and an internal path separating residential and the school and park.
- The neighborhood facilities are buffered from surrounding residential areas by open space slopes, streets, and paths, yet are accessible to residents.
- The neighborhood is laid out to maximize views in residential areas and along the public collector **loop**.
- The northern portion of the precise plan area is set aside as a natural open space, and an open space buffer is provided between Interstate 5 and the western residential areas.

2.1b Statistical Summary

Table 1 summarizes the land use acreage allocations in the precise plan area. About 78 percent of the development unit is developed, with the remainder left in natural open space. Approximately 177 acres, or 61 percent, of the developable acreage is allocated to residential uses. The remaining buildable property is devoted to neighborhood facilities, streets, and developed open spaces. All acreages are subject to minor modification during detailed **engineering** and design.

A total of 1,199 dwelling units are proposed, 289 detached units and 910 attached units. This housing will accommodate an estimated 2,900 population.

Table 1

LAND USE ACREAGE ALLOCATIONS

<u>Land Use</u>	<u>Acreeage</u> ¹	<u>Percent of Total Acreage</u>
Single-Family Detached Residential	75.5	
Attached Residential	<u>101.3</u>	
Total Residential	176.8	61%
<hr/>		
Elementary School	10.3	
Neighborhood Park	<u>5.0</u>	
Total Neighborhood Facilities	15.3	5%
<hr/>		
Power Easement	2.0	
Existing Telephone Facility	<u>0.8</u>	
Total Utilities	2.8	1%
<hr/>		
Developed Open Space	7.0	
Natural Open Space Preserve	<u>62.9</u>	
Total Open Space (excludes project open space)	69.9	24%
<hr/>		
Arterial and Collector Streets	25.5	9%
<hr/>		
TOTAL	290.3	100%

¹Subject to modification during precise engineering and design.

2.2 Residential Land Use

Figure 6 shows the proposed distribution of residential development in the precise plan area. Each residential area is shown developed with a certain density of housing, placing it within a housing **category**. The housing mix is summarized in Table 2. All acreages are subject to minor modification during detailed engineering and design; consequently, the dwelling unit calculations provided in the precise plan may be subject to some corresponding modification at the time that development plans and subdivision maps are submitted.

A total of **1,199** dwelling units are proposed on **176.8** acres, resulting in an average density of 6.8 housing units per residential acre. On the basis of the total precise plan area, the plan produces a gross density of four units per acre.

2.2a Housing Mix

Three housing categories based on density and housing type are utilized in the plan:

- **Single-family** detached, up to five dwelling units per acre.
- Lower density attached, from five up to ten dwelling units per acre.
- Higher density attached, from ten through fourteen dwelling units per acre.

The single-family detached corresponds to the "very low density" category in the Carmel **Valley Community Plan**, while the lower and higher density attached together correspond to the "low density" category in the community plan. Approximately 24 percent of the dwelling units are planned as single-family detached, with the remainder as attached.

As shown in Table 2, a population of 2,900 persons is estimated for Unit Three. This represents an average of over 2.4 persons per dwelling unit.

2.2b Housing Location

The location of residential areas and the designation of housing categories evolved from the following considerations:

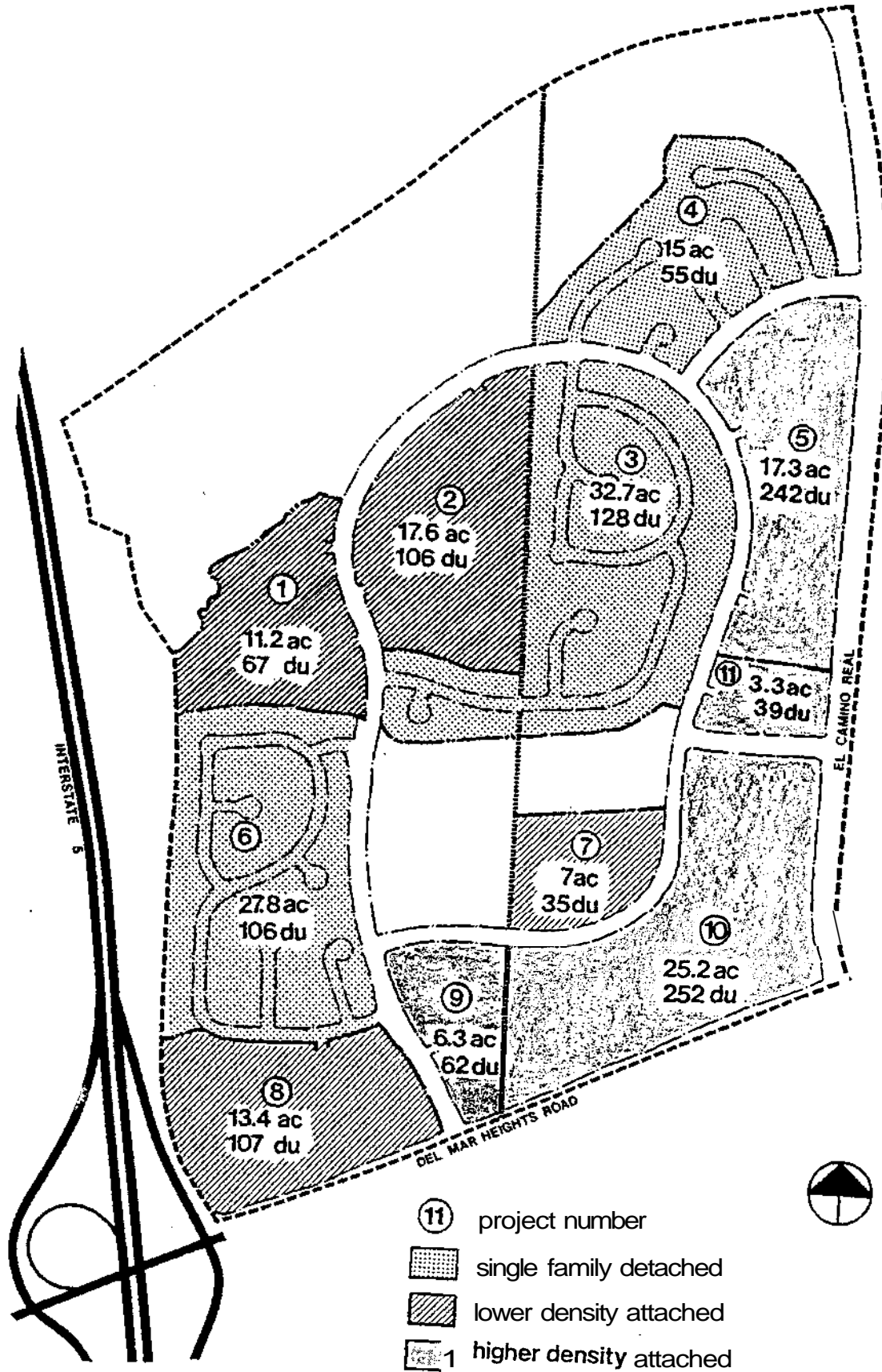

RESIDENTIAL DEVELOPMENT

Table 2
HOUSING MIX¹

Housing Category	Density Range DU/Acre ²	Area in Acres ²	Number of DU	Percent of Total DU	Persons Per DU	Estimated Population	Targeted Income Level(s)
Single-Family Detached	0 up to 5	75.5	289	24%	3.2	925	Upper middle and middle
Lower Density Attached	5 up to 10	49.2	315	26%	2.5	785	Upper middle, middle, and lower middle
Higher Density Attached	10 through 14	52.1	595	50%	2.0	1,190	Lower middle and moderate
TOTAL		176.8	1,199	100%	2.4	2,900	

¹Projections are subject to minor **modifications** during precise engineering and design.

²For site areas excluding arterial and collector streets.

- The residential locations and densities for Unit Three shown in the Carmel Valley Community Plan.
- Site planning principles, such as view **enhancement**; drainage and utilities provision; and matching topography, grading, and project and lot sizes to housing types.
- Land use compatibility and buffering as needed.
- Vehicular and pedestrian and bikeway access.

Figure 6 depicts the locations of different residential projects within Unit Three. Both single-family (Project 4) and multi-family (Projects 1, 2) areas share visual access across the natural open space to the ocean and river valley. Grading is minimized by locating detached residential in areas with difficult terrain or unusual grading requirements (Projects 3, 4, 6). As in the community **plan**, the higher density areas (Projects 5, 9, 10, 11) are concentrated in the east-southeast portion of the plan area. These areas lie in proximity to the proposed town center and employment **area**, and sit across El **Camino** Real from projected higher density residential in the development unit to the east. A sense of variety will be experienced by travelers along the collector loop, since the housing densities vary and are interspersed with neighborhood facilities.

2.2c Balanced Community

The Carmel Valley Community Plan calls for the enforcement of a balanced community housing program consistent with Council Policy 600-19. This means that a range of housing unit types and prices should be available in the community, suitable to households at a variety of income levels.

The community plan provides for this balance by correlating income levels to proposed housing categories and locations. The very low density (single-family) and low density (attached) categories in the community plan are designated for "lower middle income families" and up; these are the housing categories included in Unit Three. On the other hand, the community plan designates substantial **portions** of the proposed low-medium and medium density units for low and moderate income households; these units are planned near the town center and south of Route 56, all outside the Unit Three precise plan area.

While the Carmel Valley **Community** Plan shows Unit Three as a middle income and up **area**, there will be a range of housing types and prices within the precise plan area. This will provide housing for a variety of household types.

An effective affirmative marketing plan will be utilized in conjunction with all residential projects. The affirmative action program of the San Diego Building Contractor's Association (BCA) or equivalent should be employed, in order to ensure affirmative marketing of sale and rental units. The objective of the program should be to establish a racially balanced neighborhood through advertising and other methods, intended to inform minority and majority households that the Unit Three housing is available on an equal opportunity basis.

2.3 Neighborhood Facilities

Figure 7 illustrates the locations of the neighborhood facilities provided in Unit Three: an elementary school and a neighborhood park. These facilities should act as a focus for the neighborhood residential **development**, while providing needed neighborhood services.

2.3a Elementary School

The **Carmel Valley Community** Plan proposes a public elementary school in the Unit Three development unit. The school would be located in and administered by the Solana Beach School District. The Financing Plan for School Facilities **reexamines** school site requirements in Carmel **Valley**; this document also recommends an elementary school in Unit Three. Therefore, the precise plan proposes an elementary school site be reserved within the neighborhood. Should the site not be **required**, it should be designated as single-family detached residential (up to five dwelling units per acre).





The elementary school is located in the southwest sector of the collector loop, adjacent to the park and two residential areas. The **10.3-acre** site has been designed to accommodate a school building, parking, and recreational areas. The collector street system provides primary pedestrian and bicycle linkages between the school and Unit Three residential and park areas. An interior bike/pedway extends from the school to the detached housing area to the north. The site is buffered from housing areas to the north and east by landscaped slope banks.

Public secondary education should be provided at schools located outside Unit Three within Carmel Valley. San Dieguito Union High School already operates Torrey Pines High School, situated on proposed Del Mar Heights Road. Junior high school facilities are also planned for the community.

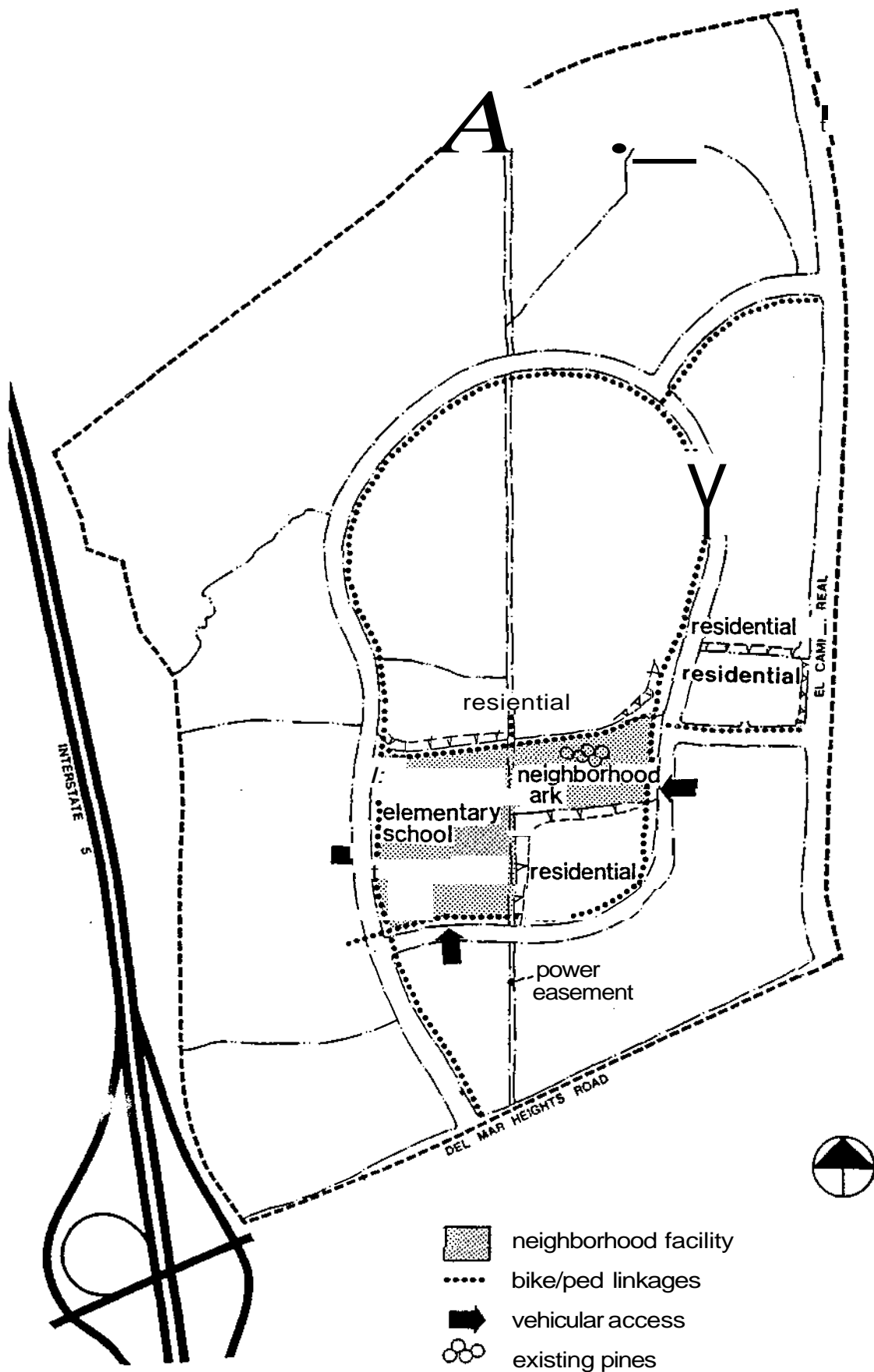
2.3b Neighborhood Park

A number of population-based parks and several open space systems are proposed in the Carmel Valley Community Plan to provide recreational **opportunities**. Within Unit Three, a neighborhood park is designated, designed to meet local recreational needs of the surrounding neighborhood population.



-  neighborhood facility
-  bike/ped linkages
-  vehicular access
-  existing pines

NEIGHBORHOOD FACILITIES

This precise plan proposes a neighborhood park, to be situated adjacent to the elementary school within the collector street system. The **5.0-acre** site was selected to maximize the preservation of existing mature Torrey Pines. While functional requirements for recreational **facilities**, parking, and internal circulation will **require** site grading, **care** will be exercised to avert grading which could detrimentally affect the Torrey Pine groupings.

Recreational facilities in the park should be selected to meet the needs of the anticipated residential population and should be coordinated with the elementary school playground to avoid unnecessary duplication. Recommended facilities are a picnic area, a **children's** play apparatus area, and lawn area. Other possible facilities include a multi-purpose play field and multipurpose courts.

Vehicular access is provided the park site from the collector streets, permitting park user access, ease of surveillance, and access by maintenance vehicles. Pedestrian paths are located in the adjacent collector loop parkway. In addition, the bike and pedestrian system runs west from El Camino Real across the collector street, to the park, and westward to the school. The park site is separated from the detached housing on the north and the attached housing on the south by slope banks.

According to the Carmel Valley Community **Plan**, community park facilities are to be developed south of the town center. Private recreational facilities may be provided as part of attached residential projects within Unit Three. Also, commercial recreation may be available in the nearby town center. Some school recreational facilities should be accessible to the public during non-school hours. In addition, recreational facilities may be available in the San Dieguito River valley.

2.4 Other Facilities and Services

In addition to the school and park discussed above, there are a number of other facilities and services which should be available to Unit Three residents. These include a range of services provided by the public, community groups, and private enterprises, as described below.

The following public services will be provided to Unit Three by the City of San Diego:

- Library service, in a library branch building to be constructed in the **Carmel** Valley town center.
- Fire protection, from a fire station to be built adjacent to the town center and from other stations in surrounding communities.
- Police protection, from an existing police substation in University City.
- Trash collection and solid waste disposal at existing and proposed City landfills and disposal facilities.
- Paramedic and ambulance service.
- Community park facilities to be developed in the town center.

Other institutions and services may be located in the Carmel Valley community and serve Unit Three residents:

- Medical/health care offices and/or clinic.
- Churches and religious **institutions**.
- Child care and private education facilities.
- Community- and service-oriented organizations and facilities, such as YMCA, youth clubs, and senior citizen groups.
- Public transit facilities, such as a transportation **terminal**.

2.5 Utilities

A number of utility services and facilities will be operated by public and semipublic agencies in Unit Three. **Figure 8** depicts the locations of major utility facilities within or next to the neighborhood.

2.5a Water

Potable water will be provided by the City of San Diego via the existing Del Mar Heights Road transmission water **main**, located in Del Mar Heights Road and traversing a portion of the southwest corner of the plan area. A new main is proposed in El Camino **Real**. Distribution within the development unit will be provided by public water mains within street **rights-of-way**.

The location and sizing of new water mains are subject to further engineering studies.

2.5b Sewer

Sanitary sewer facilities will be operated by the City of San Diego. Service will be provided from the existing El Camino Real Trunk Sewer at the intersection of El Camino Real and Del Mar Heights Road. The trunk sewer is of sufficient capacity to service Unit Three, plus future development to the north and east. The entire Unit Three plan area is located within the El Camino Real Trunk Sewer District and the southerly two-thirds lies within the Penasquitos Sewer District boundary.

Two primary sewer extensions are proposed to serve the plan area. The first will extend northerly in El Camino Real and the second westerly in Del Mar Heights Road. The El Camino Real extension will be sized to accept eventual discharge from a future pump station in Gonzales Canyon to the **north**, in addition to the **gravity discharge** from Unit **Three**.

With the exception of the most northeasterly tier of residential theater lots, the entire precise plan area can be served by gravity sewers. The remaining lots will require **pumping**, and construction of these lots will be deferred accordingly (see Section 5.2).

2.5c Drainage

Drainage facilities within the street rights-of-way or access easements will be maintained by the City of San Diego.

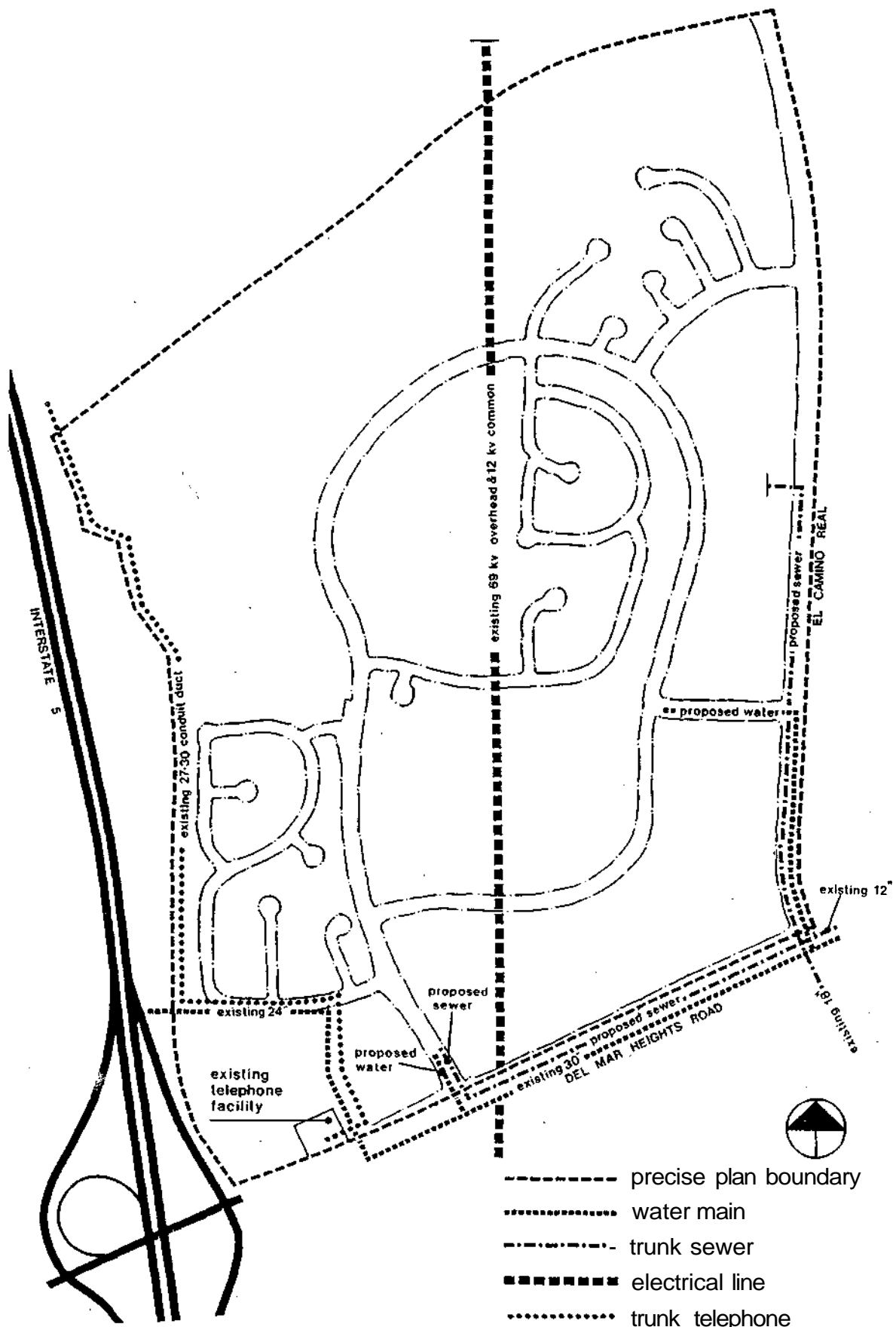

MAJOR UTILITIES

Special facilities, such as retention **basins**, may be maintained through an open space maintenance district. The location and nature of drainage facilities is addressed in Section **4.4a**.

2.5d Power

Power lines and service will be provided by San Diego Gas & Electric. Local gas and electric distribution lines will be installed underground.

An existing electric easement bisects the site, carrying 69 kv and 12 kv overhead lines. This easement must remain accessible for periodic pole cleaning and line maintenance.

2.5e Communications

Telephone service will be supplied by Pacific Telephone via underground lines, connecting into individual service laterals and prewired buildings. There is an existing telephone building on Del Mar Heights Road.

Cable television/communications will be provided by Southwestern Cable Television through underground facilities installed in common trenches along with power and telephone lines. These will connect to individual service laterals and prewired buildings.

2.6 Open Space

A substantial portion of the precise plan area is reserved as open space. Figure 9 shows a number of neighborhood-level open spaces. These areas aesthetically and **functionally** benefit the entire precise plan area, not just a particular project. In addition, most open space areas are visible to the community from roadways and surrounding development units. The freeway buffer and natural open space preserve also benefit surrounding areas and are designated open space areas in the Carmel Valley Community Plan.

There are several kinds of **neighborhood/community** open space designated (exclusive of park and school **areas**):

- Natural open space to be retained in its native **state**.
- "Developed" open space areas to be landscaped and maintained, including the freeway interchange slope, the Del Mar Heights Road **entrance**, the northern El Camino Real slope, the public view overlook to the north, and the cul-de-sac open space area west of the **school**.
- Other landscaped areas, including the freeway buffer, parkways, internal bike/pedestrian path, and major slopes with community and/or neighborhood **visibility**.
- Power easement to retain access by the utility company for maintenance purposes.

Table 3 summarizes the options available for the preservation and maintenance of these open spaces.

In addition to neighborhood-level open spaces, there are open spaces located within projects. Most of these take the form of slope banks in residential projects. For single-family detached projects, the open space areas will be lotted out, with an open space easement overlay on major slope areas. Open spaces within attached projects will be maintained by the homeowners associations or project owners.

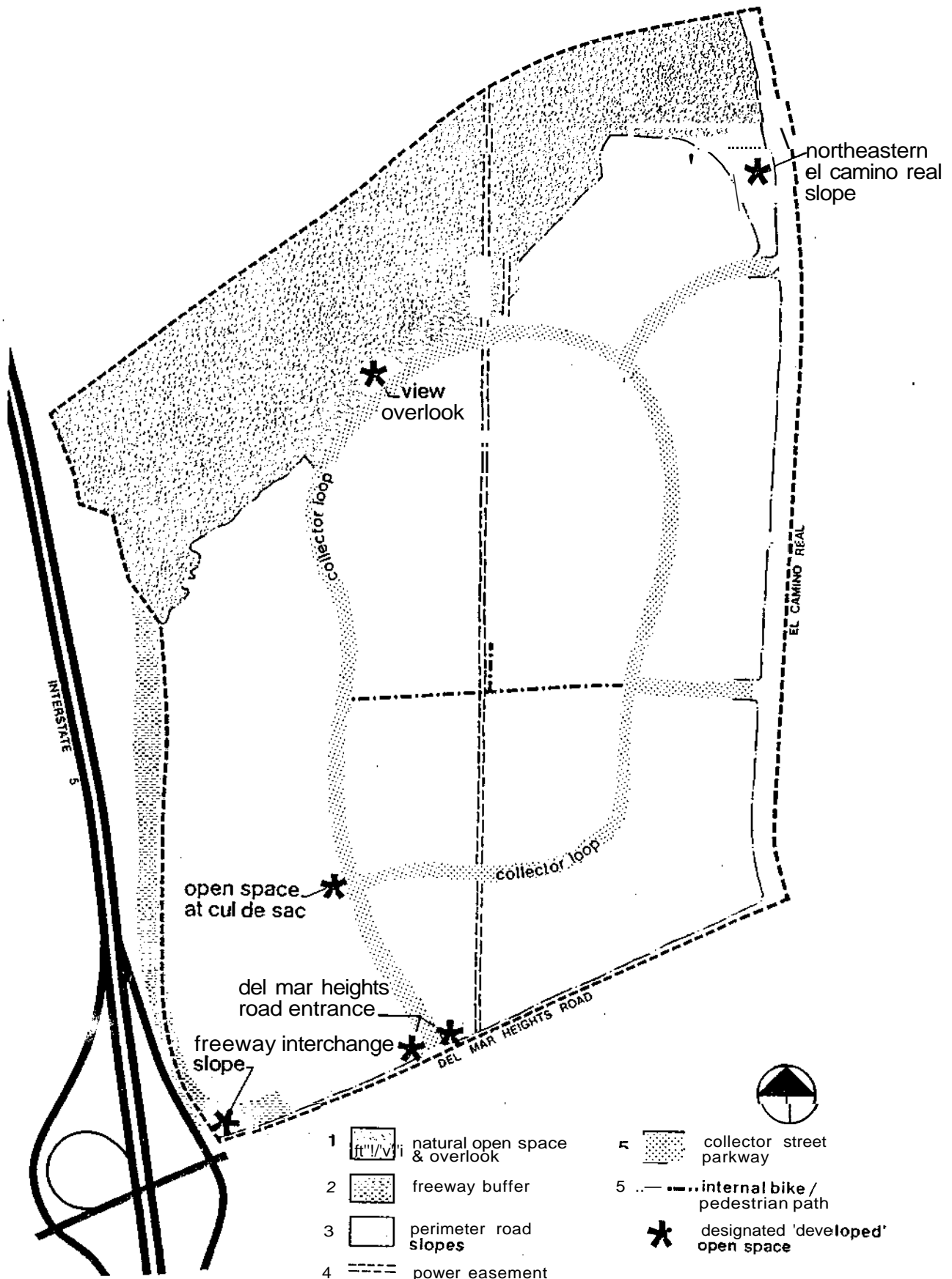

OPEN SPACE

Table 3

NEIGHBORHOOD OPEN SPACE PRESERVATION AND MAINTENANCE

Figure 10 Reference	Type of Open Space	Preservation Options	Maintenance Options
1	Natural open space pre-serve and public view overlook.	Fee ownership by City	Community open space maintenance district.
2	Freeway buffer	Ownership by Caltrans and landscaping by developer. Common area of attached residential project under open space easement. Fee ownership by City.	Caltrans. Neighborhood homeowner association. Community open space maintenance district.
3	Perimeter road, including neighborhood entrances, neighborhood/community slopes, and medians .	Common area of attached residential projects under open space easement. For northeastern El Camino Real slope, fee ownership by City. Medians within dedicated street rights-of-way .	Project open space with homeowner association fees . Community open space maintenance district. Neighborhood homeowner association.
4	Power easement	San Diego Gas & Electric Company easement .	San Diego Gas & Electric Company. Underlying project homeowner association, school district, and maintenance district for natural open space.
5	Collector loop parkway, including right-of-way, and major slopes and areas with neighborhood/community visibility.	Dedicated street right-of-way. Open space easement. Ownership by neighborhood homeowner association.	Community open space maintenance district. Neighborhood homeowner association.
6	East-west internal bike/pedestrian path along school and park.	Park ownership by City. School path owned by school district or in open space easement on school property.	City operating budget for park.
*	Designated "developed"	See appropriate category above	

Chapter 3 CIRCULATION ELEMENT

The Carmel Valley **Community** Plan proposes networks of streets, transit routes, and bike and pedestrian ways to meet the circulation needs of the community. This chapter **describes** the circulation systems providing access within Development Unit Three, as well as the connections to community-wide networks.

3.1 Community-Wide Street Systems

According to the **Carmel Valley Community Plan**, the community street system consists of a hierarchy of **arterial, major, collector, and local streets**, as shown in Figure 10. This system accesses Interstate 5 at two existing interchanges, Carmel Valley Road and Del Mar Heights Road. The freeway provides regional access from Carmel Valley to the San Diego metropolitan area.

At the present time, the community street system is under study. The proposals outlined in the remainder of this section may be revised, pending the recommendations of the community-wide study.

Development Unit Three is bounded by two important streets: Del Mar Heights Road, designated as a six-lane primary arterial, and El Camino Real, planned as a four-lane primary arterial. These roads will provide vehicular access from the neighborhood to the larger community. **Also**, community bicycle and pedestrian paths are proposed paralleling these arterial streets and tying into the neighborhood bicycle and pedestrian routes. Signals are required at the Del Mar Heights Road neighborhood entrance (across from the Unit Two Employment Center) and **the** El Camino Real neighborhood/commercial center entrance, as well as at the intersection of Del Mar Heights Road and El Camino Real.

Del Mar Heights Road has the additional role of linking Unit Three to Interstate 5 and the community of Del Mar. The Del Mar Heights Road interchange with Interstate 5 was designed and constructed to accommodate future expansion. A second bridge and ramp **modifications** will increase the capacity of the interchange to handle Carmel Valley traffic.

In order to ensure adequate access for Unit Three residents, the following improvements to the community circulation system must be completed as traffic warrants:

- Del Mar Heights Road improved from the freeway interchange to El Camino Real at full width, as described in Section 3.6 and Figure 14.
- Signalization of the neighborhood entrance on Del Mar Heights Road.
- Improvement of the Del Mar Heights Road/Interstate 5 interchange to accommodate projected traffic.

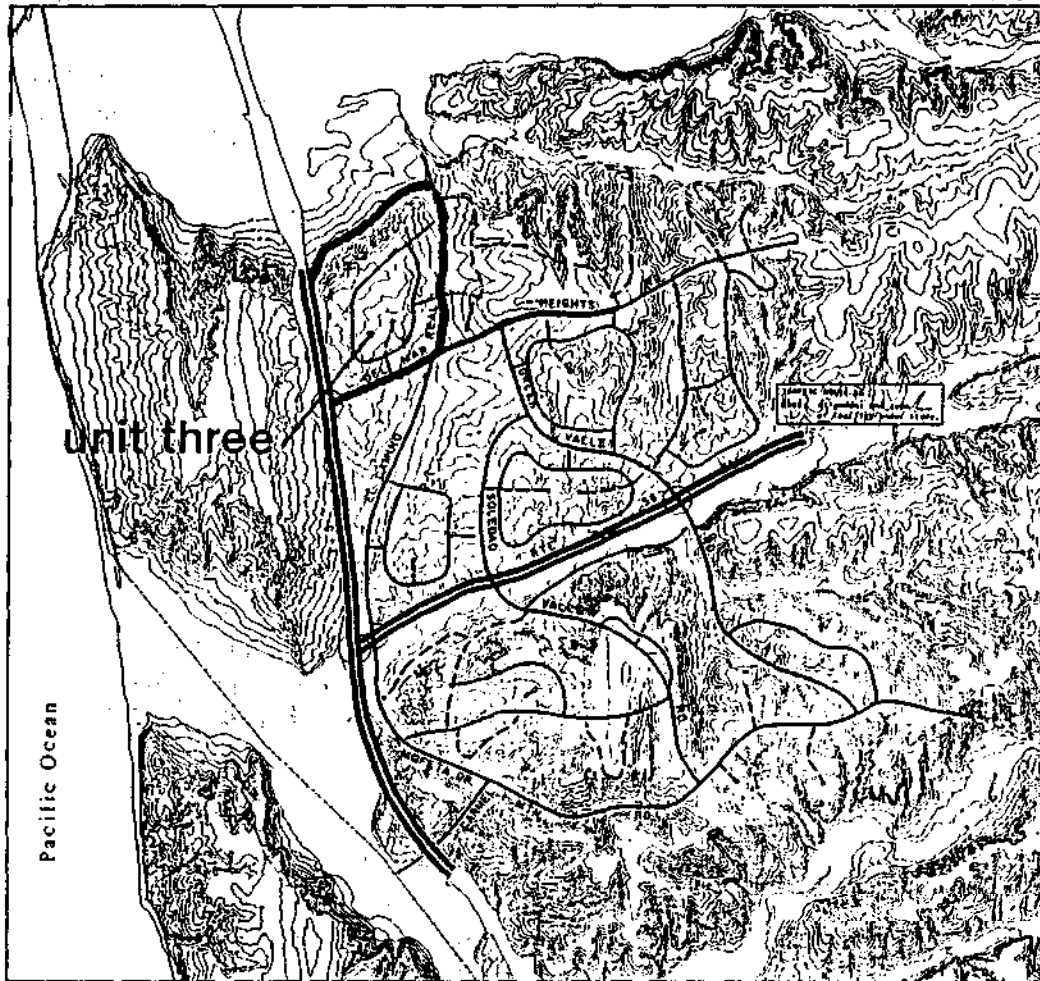

CARMEL VALLEY

PROPOSED STREET SYSTEM

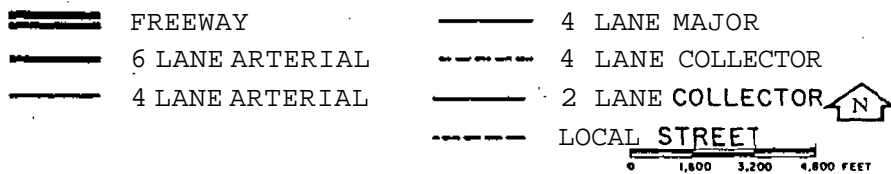

- El **Camino** Real realigned and improved to full **width**, as described in Section **3.6** and Figure 14, from Del Mar Heights Road to the northern Unit Three entrance, plus a temporary connection to the existing roadway to north. A temporary route must be provided during construction. Vacation of the right-of-way no longer needed for El Camino Real as realigned should be **undertaken**.
- Signalization of the neighborhood/commercial entrance on El Camino Real.
- Realignment and signalization of the intersection of Del Mar Heights Road and El Camino Real.

3.2 Unit Street System

The proposed street system within Unit Three is depicted in Figure 11. This system consists of the street classifications below:

- A collector street system, including an internal loop and three connections to the perimeter arterial streets.
- Local streets to access detached residential projects, including conventional streets and cul-de-sacs.
- Project streets (not shown) to access attached residential projects, anticipated to be privately maintained.

This unit street system is designed in conformance with the **Carmel Valley Community Plan**, as follows:

- The neighborhood contains only collector and local streets. Through traffic is discouraged by locating the arterial streets at the perimeter of the precise plan area and by the design of the collector road system.
- A two-lane collector loop provides access within the neighborhood and has three links to the primary arterials bounding the property.
- Only collector streets intersect with the perimeter primary arterials; local streets feed into the collector system, not the arterials. Neighborhood access is restricted to three neighborhood entrances.
- Individual residential lots receive access from local streets or private project streets, not from collector streets.
- The neighborhood facilities (school and park) are provided access from the collector streets.
- The collector street system functionally links the various land uses within the neighborhood while being aesthetically integrated into the overall Unit Three design (see Section 4.8).
- All streets will meet the City's geometric and cross-section standards for the designated street classification (see Section 3.6).

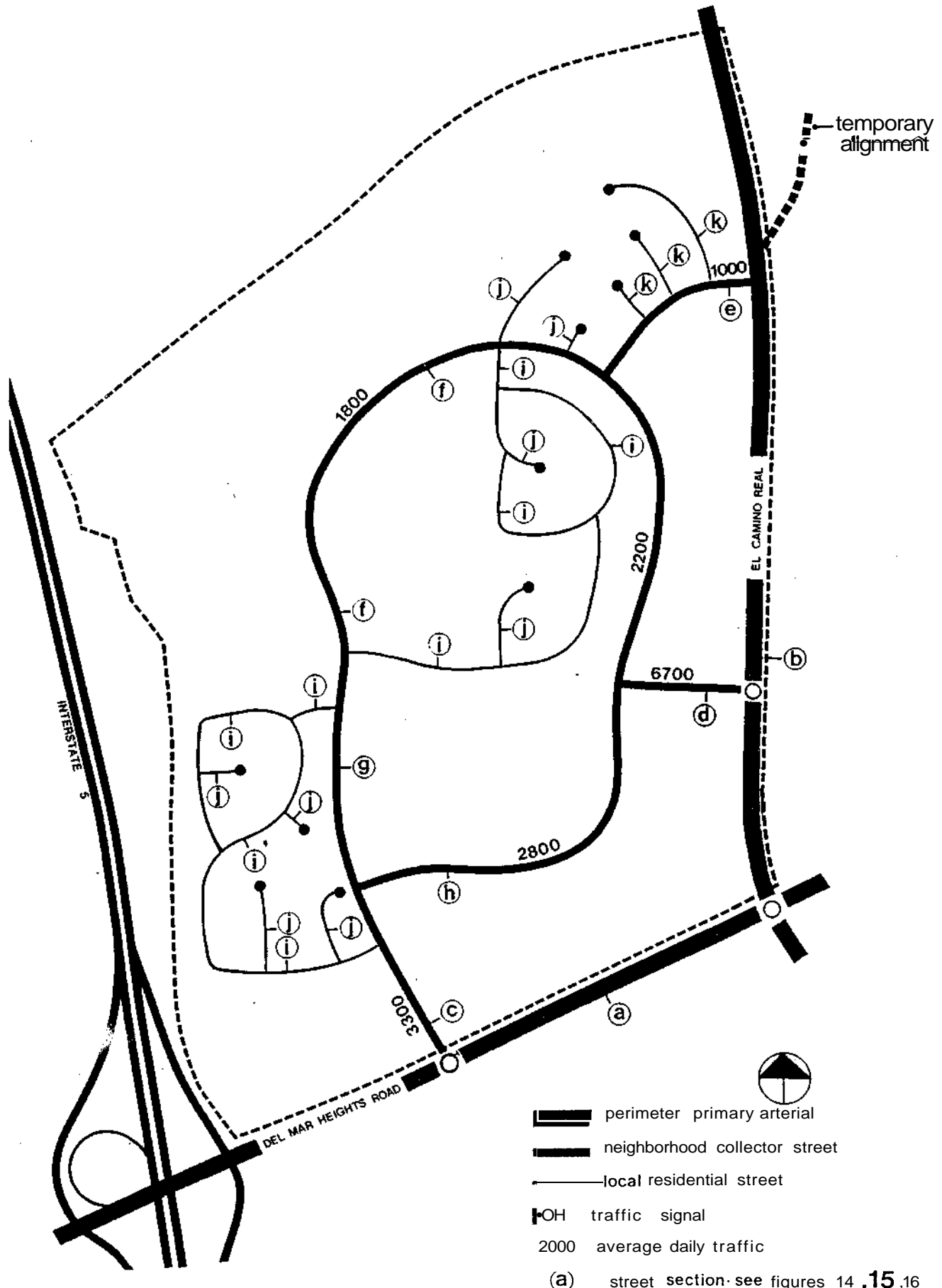

UNIT STREET SYSTEM

Figure 11 also shows the estimated average daily traffic (ADT) along Unit Three streets. These numbers represent the anticipated number of **vehicles**, or volume, in a 24-hour period under full build-out of the neighborhood. The street system is designed with adequate capacity to accommodate the projected ADT. Section 3.6 describes the typical street **sections** noted in Figure 11.

Vacation of the existing Black Mountain Road should be undertaken when the road is no longer needed in the precise plan area. This **vacation**, as well as El **Camino** Real vacations resulting from realignment of the arterial, should be coordinated with future subdivision and improvement plans.

3.3 Alternative Transportation Modes

The Carmel **Valley** Community Plan stresses the importance of transportation alternatives to the private automobile, including public transit, bicycle travel, and pedestrian movement. Complete transit, bikeway, and pathway systems are proposed for the community. The automobile, **transit**, bicycle, and pedestrian facilities are to be developed in an integrated network, providing a "balanced transportation system" assuring mobility and access to all parts of the community. Under the community plan objectives, the Unit Three precise plan must provide adequate internal transit, bicycle, and pedestrian alternatives tied into the community circulation network.

3.3a Transit

Unit Three is located northwest of the Carmel Valley town center. A transportation terminal is proposed in the community plan at or adjacent to the town center. Regional and subregional transit in the form of buses is expected to travel on Del Mar Heights Road from the freeway, past Unit Three, to the transportation terminal.

Aside from its proximity to the town center terminal via motorized, pedestrian, and bicycle linkages, Unit Three may be provided local transit service. The neighborhood collector streets can accommodate local buses, **dial-a-ride, and/or para-transit**. Any permanent stops required should be sited along the loop. One possible transit routing within Unit Three is shown in Figure 12; other routings are possible.

3.3b Bicycle Circulation

A neighborhood bikeway system for Unit Three is depicted in Figure 12. This system provides internal bicycle circulation, while linking the neighborhood to the community bike route network and community activity centers.

The neighborhood system includes the following bicycle facilities:

- Marked bicycle lanes within the roadbed of the collector streets, including linkages to the community bike routes along Del Mar Heights Road and El Camino Real.
- A combined internal bicycle/pedestrian path north of the school and **park**, linking the neighborhood facilities.

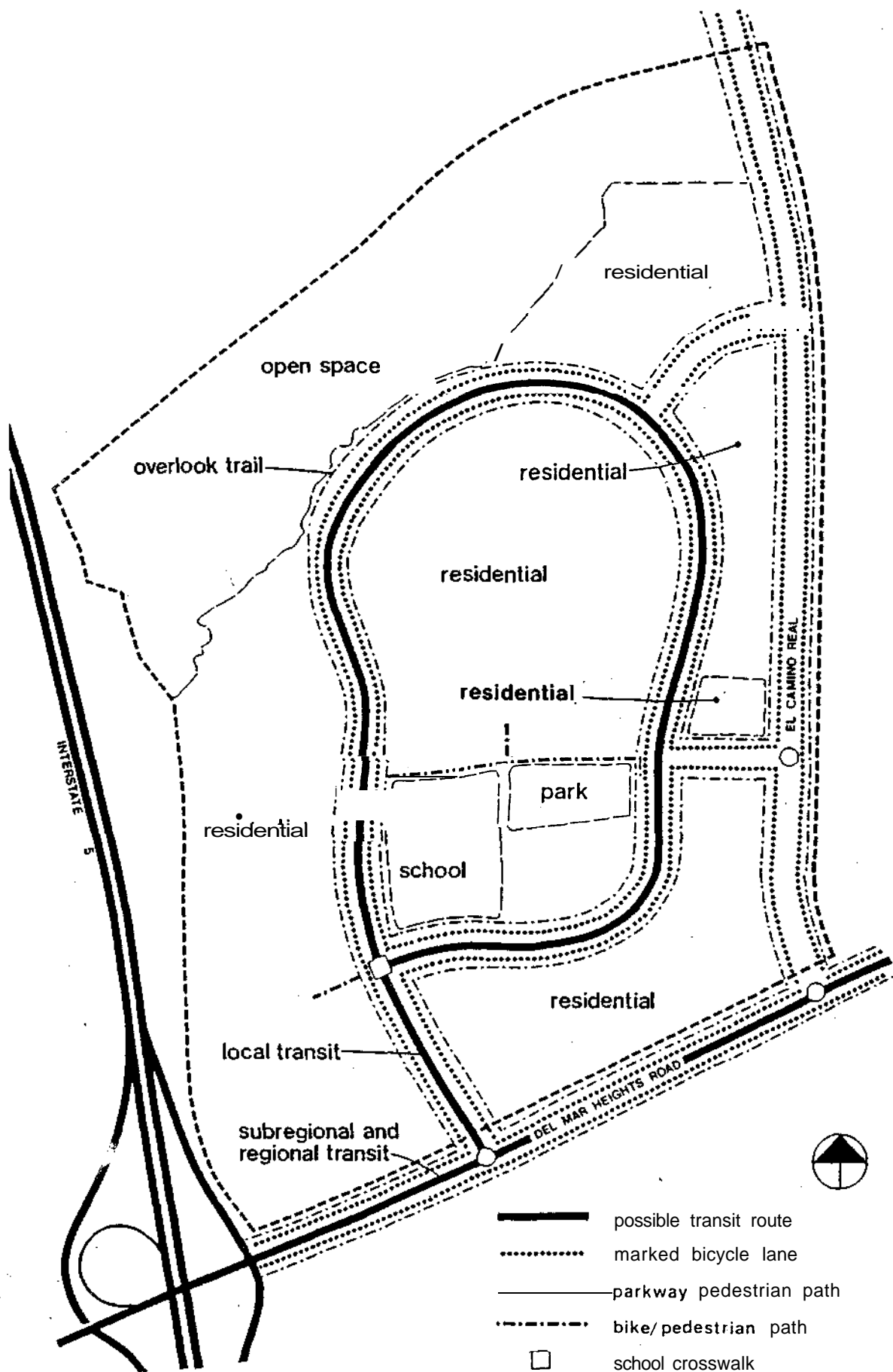

ALTERNATE TRANSPORT

- Bicycle movement within the roadway of local streets and private roads, providing access to residents (not shown).
- Traffic signals and crossings at the two important neighborhood entrances, where the neighborhood and community bikeways tie together.
- Bicycle parking facilities as described in Section 3.5 below.

3.3c Pedestrian Movement

A pedestrian path network for Unit Three is proposed as shown in **Figure 12**. This system of paths for walking and jogging links the various residential projects and neighborhood facilities within the precise plan area. In addition, ties are provided to the community-wide pathway network.

The neighborhood path system incorporates the following elements:

- Sidewalks within the collector system along the roadway, including ties to the community pedestrian paths along Del Mar Heights Road and El Camino Real.
- A combined internal bicycle/pedestrian path north of the school and park, linking the neighborhood facilities.
- Standard sidewalks along local residential streets and pathways within attached housing projects (not shown).
- Traffic signals and crossings at the two important neighborhood entrances.
- Special accessways connecting pedestrian paths, as shown in **Figure 12**.
- Special school crosswalk(s) outlined with standard yellow painted lines in accordance with the Manual of **Uniform Traffic Control Devices**, and located to the satisfaction of the City Traffic **Engineer**.

3.4 Community and Unit Interface

Figure 13 depicts the transportation linkages between Unit Three and the surrounding Carmel Valley community. These linkages ensure access from Unit Three to community **facilities**, such as the town center, employment center, and high school. In addition, access is provided from surrounding areas to Unit Three neighborhood facilities, such as the elementary school and park, and public overlook. Access to Unit Three facilities is particularly important from the residential neighborhood planned to the east across El Camino Real.

The linkages between the neighborhood and surrounding community consist of streets and parallel bicycle routes and pedestrian walks. The Unit Three collector street system with paths is connected into the perimeter arterial streets, also with paths. Crossings and signals where necessary are provided at street **intersections**. These crossings provide ease of access to the employment center to the south and residential neighborhood to the east. Transit service may be provided connecting the neighborhood to the town center transport terminal and other portions of the Carmel Valley community.

In addition to linkages to the surrounding community, Unit Three will have good access to the San Dieguito River valley. El Camino Real and proposed parallel bicycle and pedestrian routes will link the neighborhood to the valley.

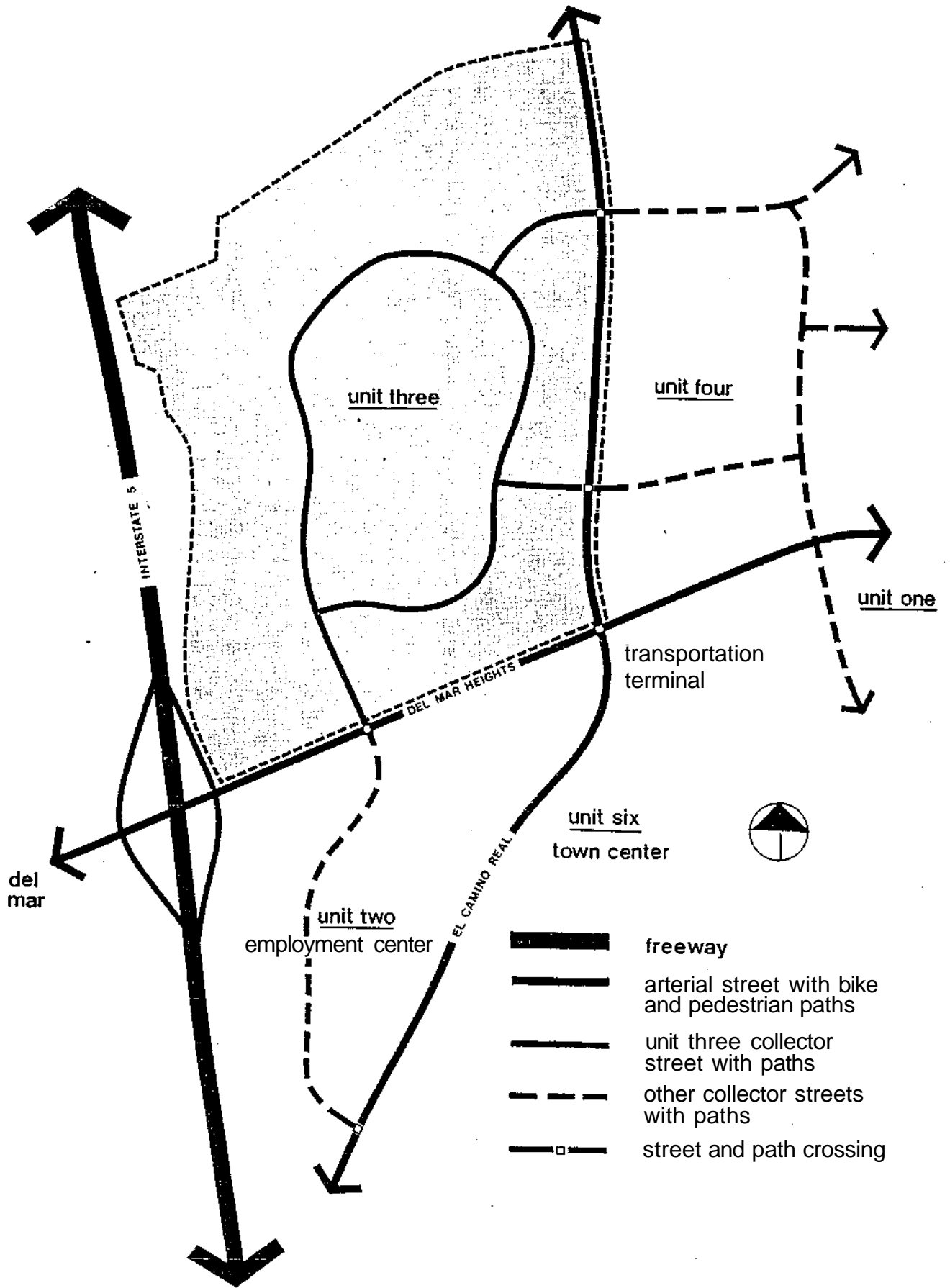

COMMUNITY TIES

3.5 Parking

Adequate parking should be provided for each residential project and neighborhood facility as it is developed. Emphasis should be placed on supplying sufficient off-street parking. Standards for off-street parking are incorporated in the zoning regulations for each type of use in the Planned District Ordinance. Design treatment of parking areas is discussed in Chapter 4. No parking is permitted in the collector system because the areas next to the curbs are reserved for bicycle lanes.

Bicycle parking should also be provided at high activity areas and important transit stops. High activity areas include the elementary school and the neighborhood park.

3.6 Street Sections

Typical street sections for the perimeter arterials of Del Mar Heights Road and El Gamino Real are shown in Figure 14. Both roads will be improved to full width, providing travel lanes and a landscaped median. Bicycle travel is accommodated in a marked lane next to the curb, while pedestrians are provided a sidewalk parallel to the roadway. Design treatment of these arterials is addressed in Section 4.7.

Figure 15 illustrates street sections for the collector street system within Unit Three. Sections "c" through "e" show the engineering design of the three neighborhood entrances into the precise plan area, while Sections "f" through "h" depict typical conditions along the interior loop. For the locations of the sections, see Figure 11.

The neighborhood entrance sections are designed to accommodate relatively high volumes of traffic, permitting turning movements as **required**. The interior loop sections provide for two travel lanes, one in each direction. All the collector sections include bicycle lanes next to the curb, with no parking permitted. Pedestrian paths are provided within the right-of-way on both sides of the road, but in variable locations depending on the design situation. For a discussion of the design treatment of the collector system as a parkway, see Section 4.8.

Figure 16 depicts typical local street sections within detached residential areas. Three types are shown: a residential street, a residential cul-de-sac, and a single-loaded residential street serving theater lots. Sidewalks are provided as needed next to the curb.

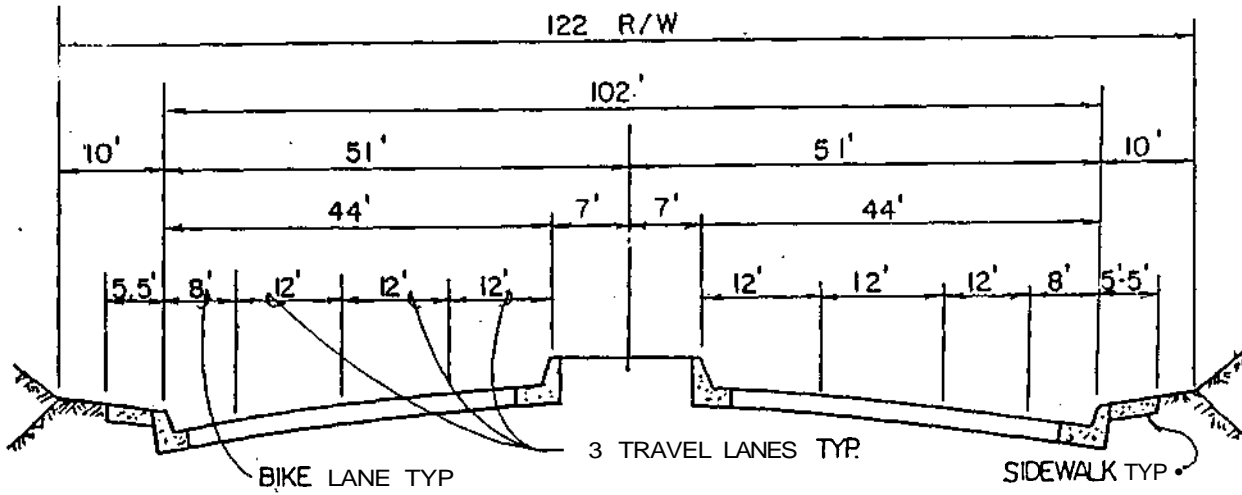

section a
del mar heights road

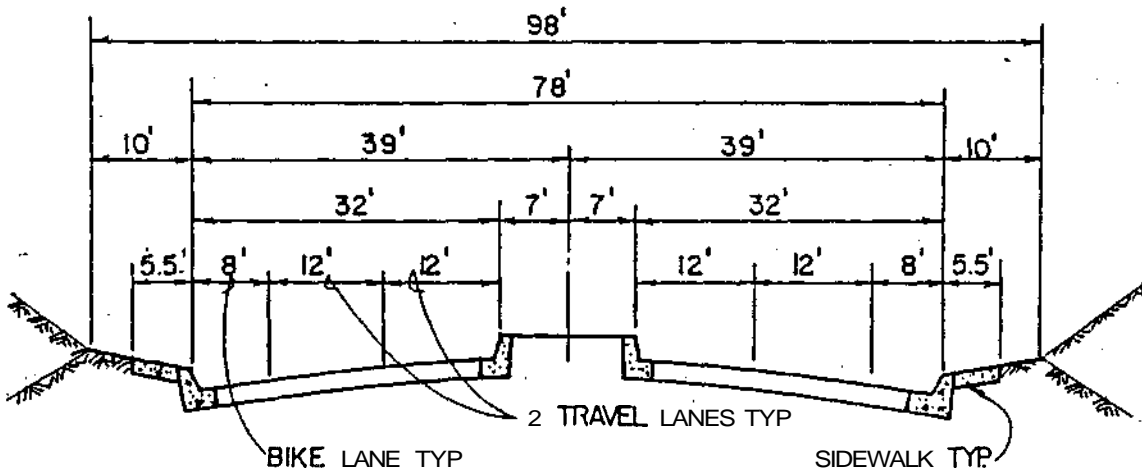

section b
el camino real

note: for location of sections , see figure 11

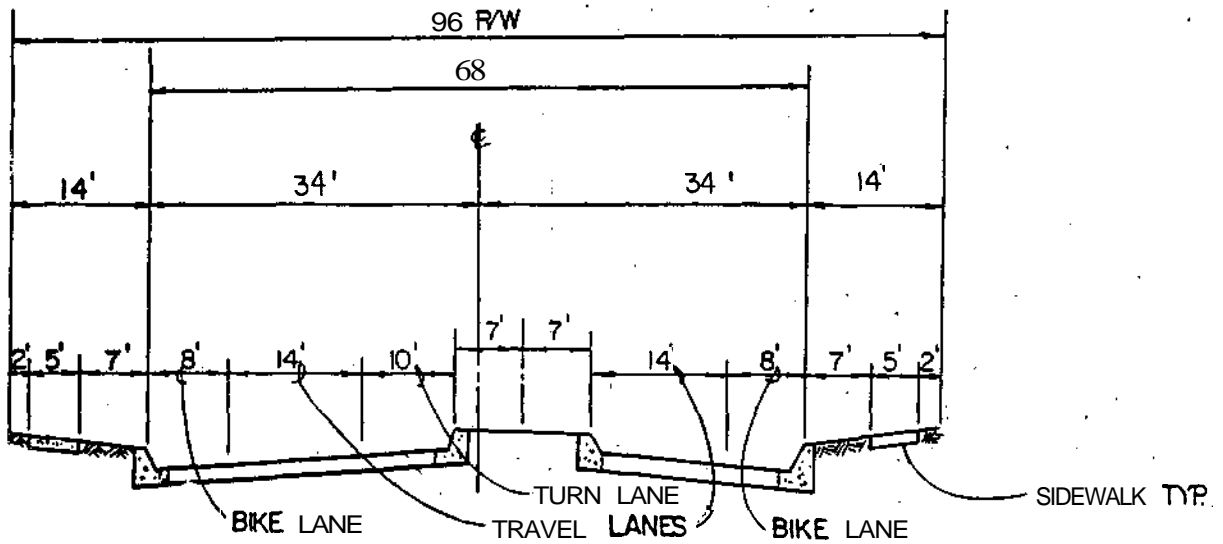

section c

del mar heights road entrance

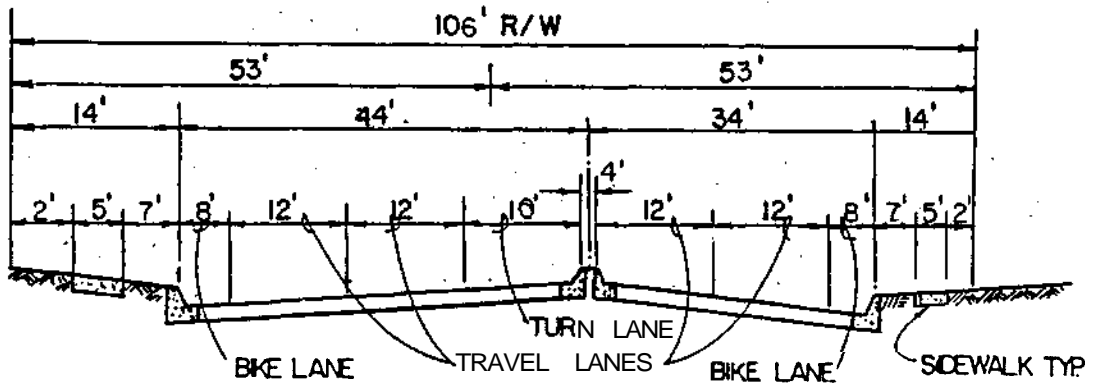

section d

quarter mile drive

note: for location of sections, see figure 11

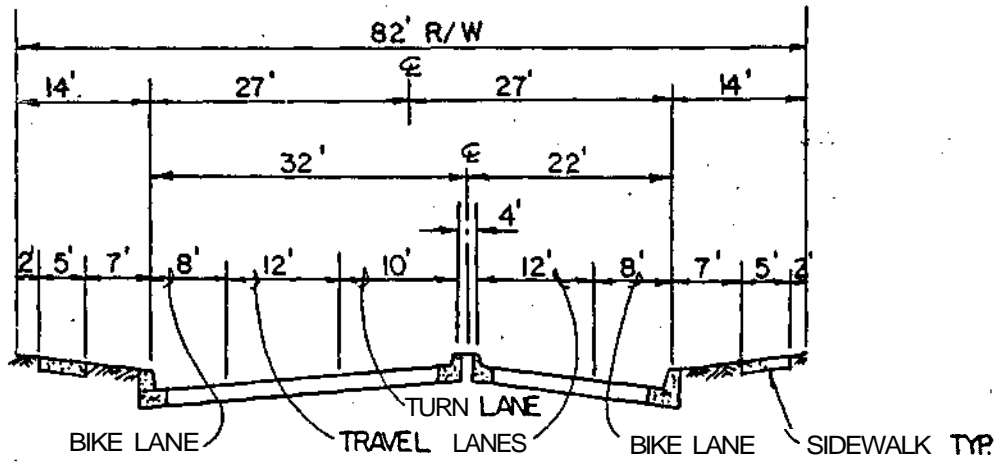

section e
camino real/north entrance

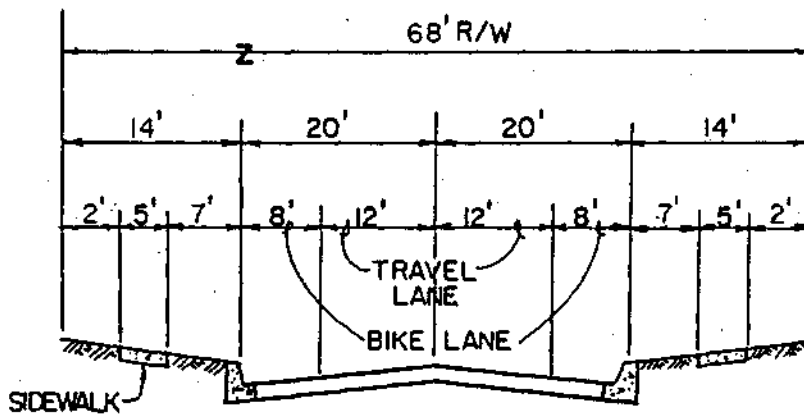

section f
typical interior loop

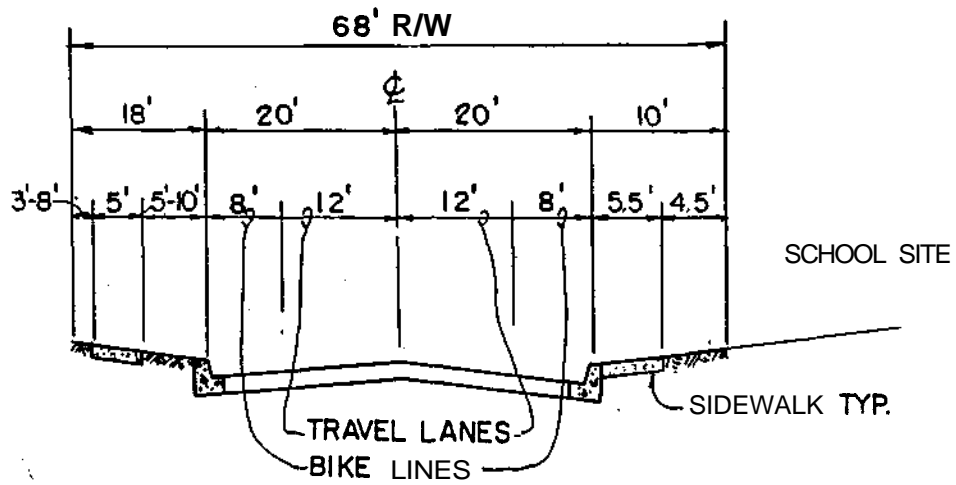

section g
interior loop west of school

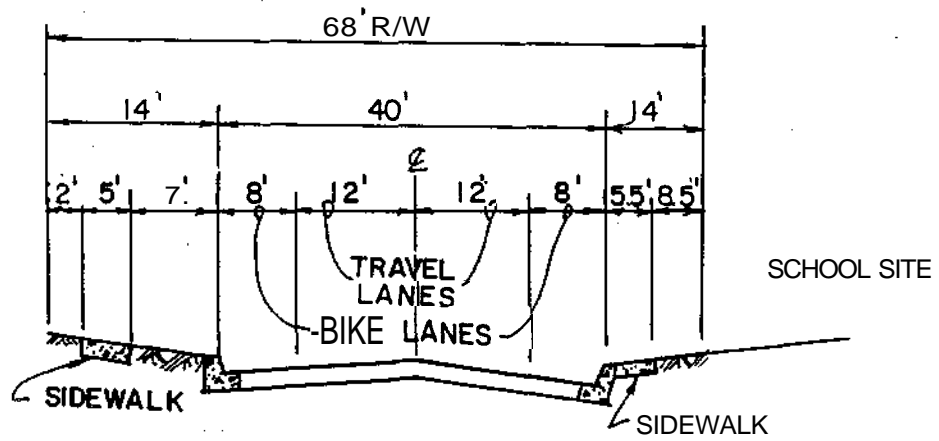

section h
interior loop south of school

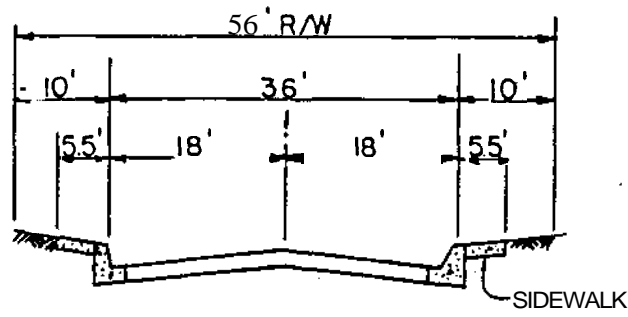

section i
residential street

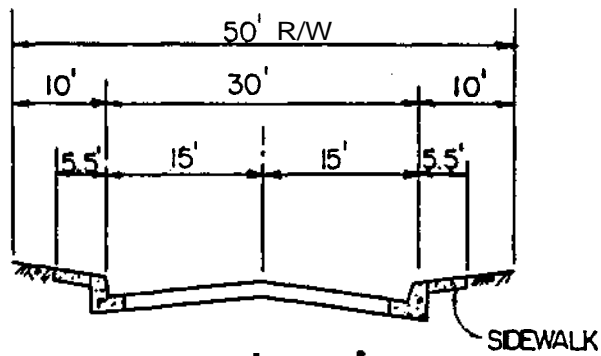

section j
residential cul-de-sac

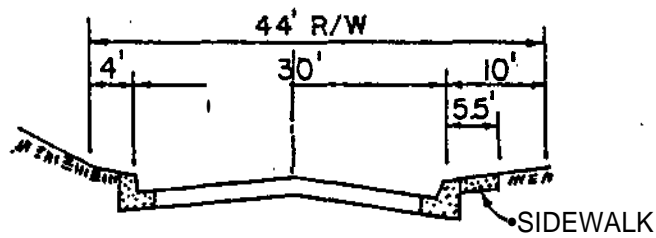

section k
single loaded residential street
[theatre lots]

note: for locations of sections, see figure 11

Chapter 4 DESIGN ELEMENT

The purpose of this element is to set forth design objectives and concepts to guide designers, **developers**, and review agencies in implementing Development Unit Three. The **overall** goal is to create an aesthetically and functionally outstanding residential neighborhood, while contributing to the community identity of Carmel Valley as a whole. The design objectives and the neighborhood design approach provided in this chapter further articulate this goal.

In addition, design guidelines and standards for each land use or design area are outlined. These are formulated to give design guidance while providing flexibility. Detailed solutions in site planning, landscaping, and building design may then meet overall requirements and conform to neighborhood-level concepts while being responsive to individual conditions and project-level concerns. A particular design motif or architectural style is not recommended, but instead a series of design concerns are called out which should be addressed in design solutions. All proposals in regard to grading, drainage, landscaping, and conservation are general or conceptual in nature and are subject to refinement and modification during the development plan and subdivision map stages.

The Design Element is designated by the Planned District Ordinance as the guideline for design review of Unit Three projects by the City.

4.1 Design Objectives

The following general objectives should be considered in the design of project sites, buildings, and landscapes:

- Meet functional requirements as described in the Land Use and Circulation Elements, such as land use separations and circulation linkages.
- Permit reasonable grading while retaining the overall **landform**.
- Maximize view opportunities.
- Preserve key environmental features where feasible, such as Torrey Pines groupings and sandstone bluffs.
- Attenuate traffic noise.
- Provide for adequate drainage.
- Incorporate conservation practices into the design and maintenance of **buildings** and spaces.
- Create neighborhood unit identity while contributing to the overall identity of the Carmel Valley **community**.

4.2 Neighborhood Design Approach

In Section 1.4 and accompanying Figure 4, an analysis of the precise plan site is outlined. This site analysis provides the basis, along with market conditions and government policy, for the design approach to Unit Three.

The design approach emphasizes view enhancement and neighborhood identity within the community context. Figure 17 graphically presents the design principles which should be **utilized** in neighborhood development.

Emphasis is placed on making external views of the ocean, the San Dieguito River valley, Del Mar, and **Carmel Valley** community available from as many residences as possible within the neighborhood. Where external views cannot be **created**, projects emphasize creating internal visual amenities. Similarly, the collector loop is designed and aligned to capture external views where feasible. But in **addition**, the collector parkway and perimeter arterial streets receive design treatments to maximize their "internal" aesthetic **quality**.

The design approach also stresses creation of a strong sense of neighborhood identity while contributing to the community's identity. Public areas within the neighborhood, such as neighborhood facilities and the collector parkway, share design treatments in order to establish a sense of **cohesiveness**. In addition, the interfaces between the neighborhood and the community reflect design elements from the neighborhood as well as **community-wide** design concepts or treatments. **Grading**, landscaping, and design features also emphasize the distinct identity of the Unit Three neighborhood while blending into and helping create the community **context**.

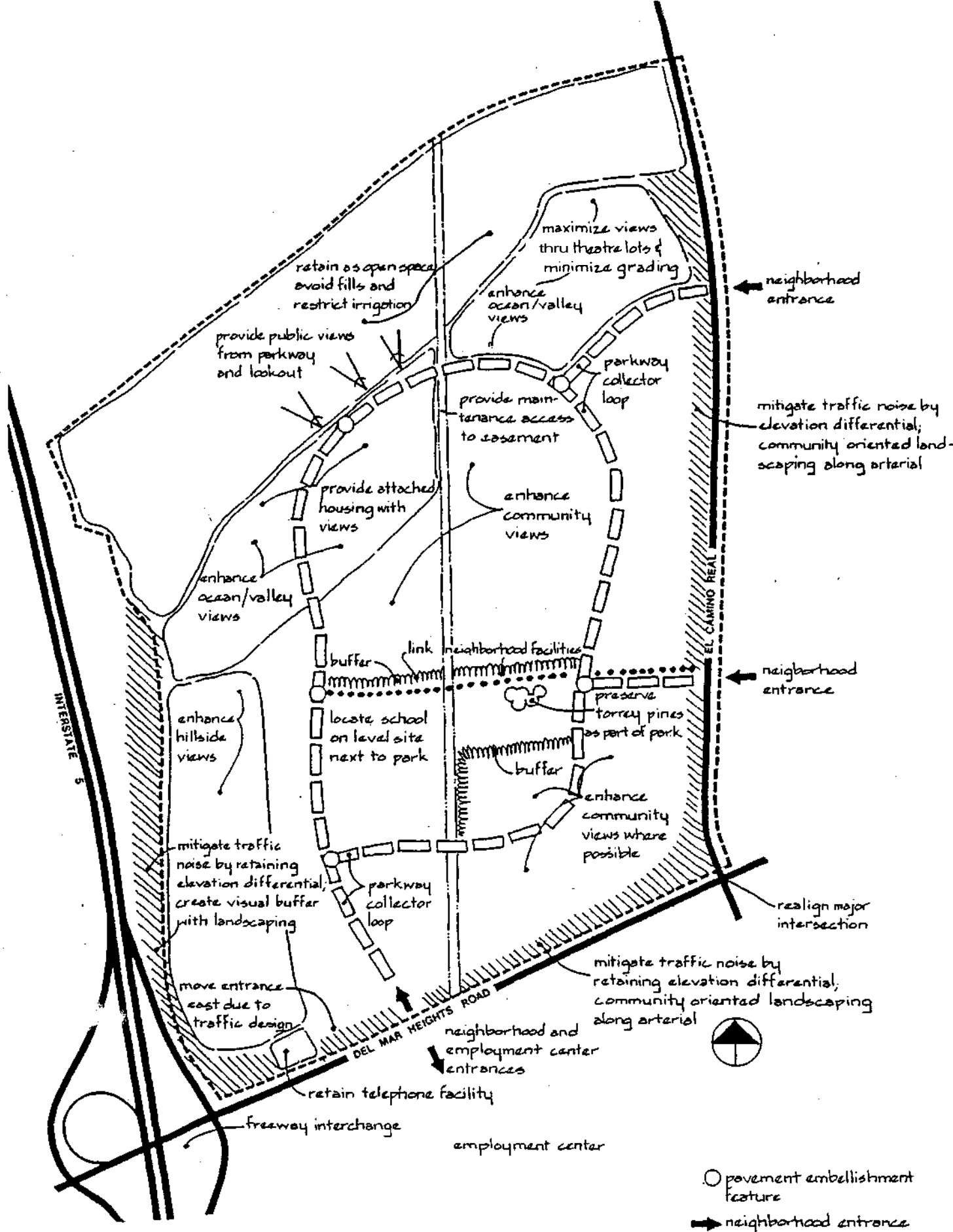

UNIT DESIGN APPROACH

4.3 Grading Concept

The grading concept for the Unit Three area is based on the following objectives:

- Preserve the northern portion of the plan area as natural open space.
- Maximize view opportunities in the developable portions of the site.
- Permit reasonable grading for **development**.
- Minimize any surface drainage to slope areas.
- Contour selected slope areas with **neighborhood/** community visibility to produce a natural **appearance**.
- Provide adequate sight distances at intersections so that motorists will have time for proper intersection **maneuvers**.
- Maintain a 30-foot maximum height on slopes to avert benching.
- Retain an existing grouping of Torrey Pines in the neighborhood park.

The overall concept is to preserve portions of the precise plan area as open **space**, while grading the remainder to develop usable sites and to enhance views.

4.3a Neighborhood Grading

On a neighborhood level, the grading concept calls for cutting in the northern and southwestern portions of the property and filling in the southeast and east portions. Figure 18 depicts the overall grading approach.

The bluffs area and native vegetation in the northern **quarter** of the precise plan area are retained in their **natural** state to the extent possible, helping maintain a natural/rural character along the San Dieguito River valley. In the northwestern portion of the precise plan area, geological studies indicate fills over the steep sandstone bluffs are undesirable. The grading approach is to cut back from the bluffs, creating a step-up pattern southward toward the high areas of the site. This approach increases view

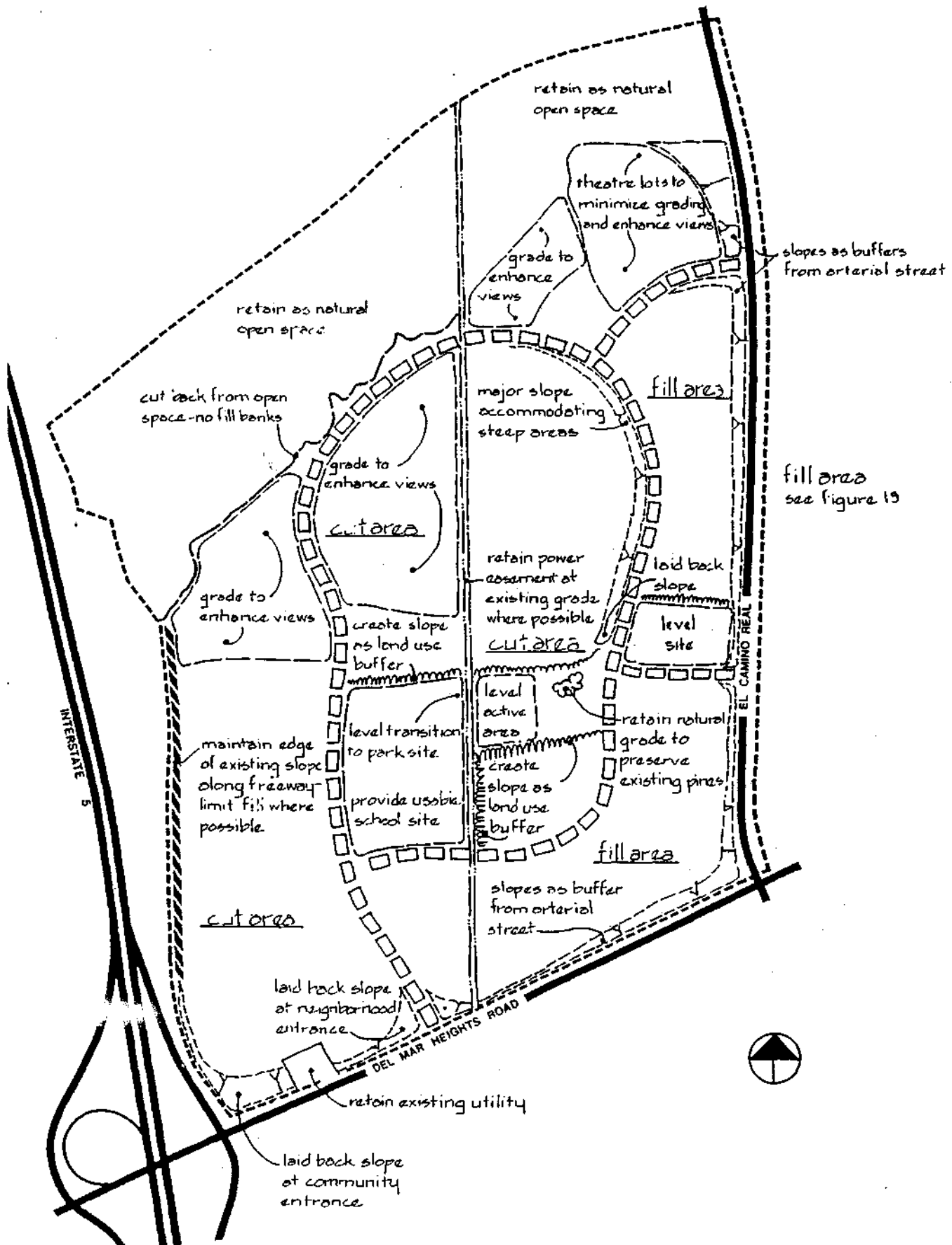

GRADING CONCEPT

opportunities toward the ocean and river valley from the residential areas. For the difficult terrain in the north-eastern part of the **neighborhood**, detached residential is proposed on a series of cul-de-sacs, some in the form of theater lots on single-loaded streets. This approach maximizes views while minimizing grading.

Fills next to the freeway cut along the western portion of the plan area are minimized where possible and softened with landscaping. The slope at the freeway interchange is laid back and contoured around the proposed development pad for attached residential housing; a **berm** is proposed at the top of the slope.

In south and east portions of the precise plan **area**, the land generally receives fill. Figure 19 illustrates the filling required to fit future development areas east of the plan area to the realignment of El Camino Real. This fill is generated by cuts in the western half of the **neighborhood**.

On the park site the existing stand of Torrey Pines is preserved, and the school site is graded to provide usable site areas and a smooth transition to the park elevations. Slopes are retained as buffers between the developable areas and the traffic on Del Mar Heights Road and El Camino Real. Between pads, slope banks are also utilized to buffer different land uses and different residential projects.

Figure 19 and the Precise Plan Map (see Page 121) illustrate grading for El Camino Real and the Unit Three area. The details of the grading scheme are subject to refinement and modification during precise engineering.

4.3b Project Grading

Slope banks should be limited to a 30-foot height, to avoid benches. All grading of slopes should be contoured to achieve a natural, rounded effect. A manufactured appearance with harsh transitions between tops, bottoms, and sides of slopes should be avoided. Slopes should be rounded at tops, smoothed at bottoms, and blended at sides. Use of variable slope ratios is encouraged both vertically and horizontally. The maximum gradient should be **2:1**, except at the neighborhood entrances and freeway interchange where **3:1** is the desired maximum. Like slope banks, earth berms and mounds should be rounded and natural in character. All slopes should be prepared to readily support landscaping.

All grading operations should take into account the potential for erosion and settling. To the extent feasible, earth moving should be accomplished in phases, to avoid

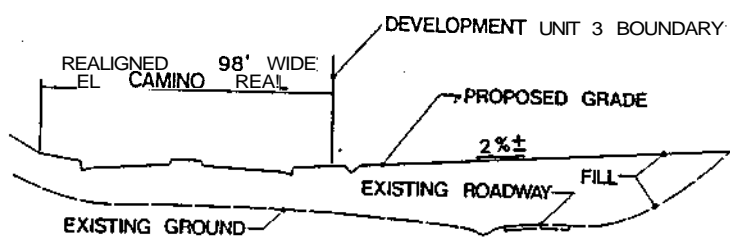
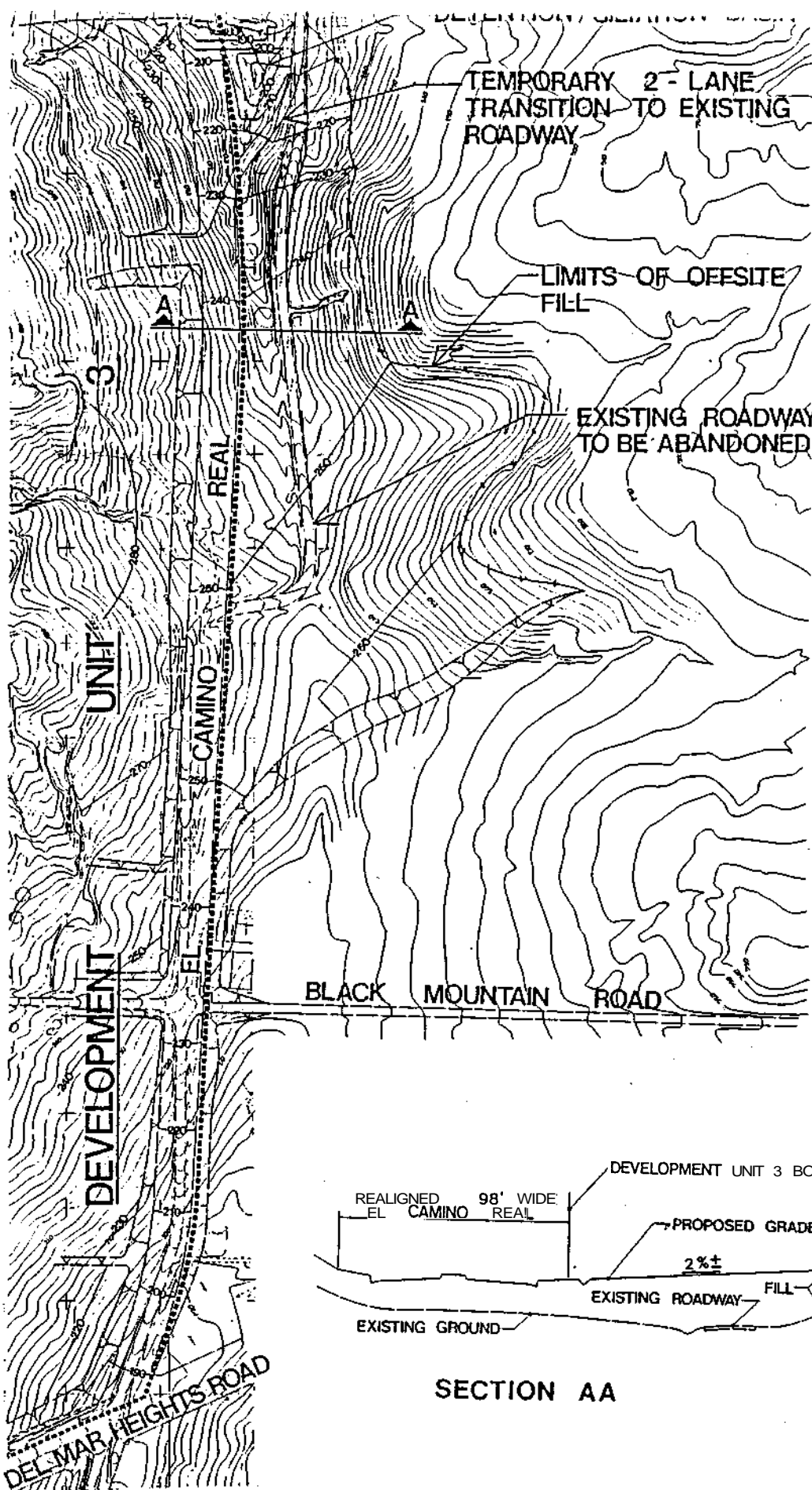

OFF-SITE GRADING

clearing of ground far in advance of grading. Grading should be limited to what is necessary, such that spillovers into natural areas are avoided and native vegetation to be preserved is not trampled. The final earth surface should be watered and rolled to form a hardened, compacted cap of soil which will minimize dust and erosion.

4.4 Drainage

The drainage proposals set out in this section are based on the **Carmel Valley** Specific Drainage Plan and subsequent investigation of drainage requirements for Development Unit Three prepared by **Leeds, Hill, and Jewett, Inc.**

The specific drainage plan examines the entire Carmel Valley community, with the following objectives:

- Limit the rate of rainfall runoff from proposed development to the rate under natural conditions.
- Control soil erosion, sedimentation, and erosion of stream banks.
- Minimize runoff pollution from urban areas and mitigate pollutant impacts on the Los Penasquitos and San Dieguito Lagoons.

A number of measures suggested by the Carmel Valley drainage plan and the Unit Three study are applicable to project development and are summarized below.

4.4a Neighborhood Drainage

The proposed drainage pattern for the Unit Three neighborhood generally conforms to the existing drainage **pattern**, with no significant diversions. The natural open space area continues to drain toward the San Dieguito River valley and is not irrigated. Detention basins are provided **off-site** to intercept runoff from the remainder of the plan area and to reduce flow volumes and velocities to acceptable levels, prior to discharge into the Los Penasquitos and San Dieguito Lagoons. Storm drains will be installed in El Camino Real and Del Mar Heights Road to handle Unit Three as well as other Carmel Valley development units.

According to the Unit Three Planned District Ordinance, the first tentative map in Unit Three is subject to City approval of a comprehensive drainage plan for the entire precise plan area. This plan must show both temporary and permanent drainage facilities which are to be installed to **control** or mitigate soil erosion, silting of lower slopes, slide damage, and flooding problems.

4.4b Project Drainage

On the project or subdivision basis, the following measures should be utilized during design and construction to reduce rainfall runoff and minimize erosion:

- . Compliance with current drainage design policies set out in the City Drainage Design Manual.
- . Use of porous hardscape and other surfaces where applicable which permit rain infiltration "at the source."
- . Sandbagging of roadbeds where necessary to minimize erosion and prevent sediment transport, until paved.
- . Restriction of grading to the seven-month period between March 15 and October 15 each year.
- . Conditioning and planting of all exposed, graded slopes before November 1 of each year, using procedures outlined in County Special Condition R-23, or equivalent.
- . Close phasing of grading operations and slope landscaping to reduce the susceptibility of slopes to erosion.
- . Control of sediment production from graded building pads with low perimeter berms, jute matting, sandbags, bladed ditches, or other appropriate methods.

In addition, required temporary and permanent drainage facilities should be constructed on-site, concurrently with grading operations. This includes such facilities as storm drains, retention basins, sediment basins, and energy dissipators. For each project, a comprehensive landscaping and irrigation plan for all graded slopes should be prepared to provide for rapid slope stabilization during and after construction.

4.5 Landscape Design

The landscape guidelines for Unit Three are based on the following objectives:

- Create an identifiable **neighborhood**, while complementing the Carmel Valley community as a whole.
- Enhance good views and screen undesirable views from residential projects.
- Employ the conservation ethic in precise plan projects and facilities.
- Stabilize and beautify project and **neighborhood/** community slopes.

This section proscribes general guidelines for landscape design and maintenance. In Sections 4.7 through 4.12, more detailed information is provided concerning landscaping on a case-by-case basis. Open space maintenance is addressed in Section 2.6 of the Land Use Element.

The entire neighborhood should be developed in a compatible plant material palette. Primary trees are proposed for particular public uses and areas, to create a sense of cohesion and continuity. The Recommended Tree List is provided in Table 4.

All landscape recommendations are conceptual in nature and are subject to refinement and modification during the development plan/subdivision map stages. Detailed landscaping plans will accompany plans for each residential project and neighborhood facility.

4.5a Plant Selection

All plants should be in accordance with the California State Department of **Agriculture's** regulations for nursery inspections, rules, and grading. All plants should have a habitat of growth normal to that species and should be sound, **healthy**, vigorous, and free of insect **infestations**, plant diseases, and objectionable **disfigurements**. They should have normally well-developed branch systems and vigorous and fibrous root systems which are not root or pot bound.

The size of plants will correspond with that normally expected for the species and varieties of commercially available nursery stock. All plants should be adaptable to the climatic conditions of the area in which they are planted.

Table 4

RECOMMENDED TREE LIST

Alnus rhombifolia	White Alder
Arbutus unedo	Strawberry Tree
Bauhinia variegata Candida	White Orchid Tree
Cupaniopsis anacardiodes	Carrotwood
Erythrina caffra	Kaffirboom Coral Tree
Erythrina coralloides	Naked Coral Tree
Eucalyptus cladocalyx	Sugar Gum
Eucalyptus sideroxylon	Red Ironbark
Ficus rubiginosa	Rusty-leaf Fig
Koelreuteria paniculata	Golden Rain Tree
Liquidambar styraciflua	Sweet Gum
Melaleuca leucadendra	Cajeput Tree
Metrosiderous excelsa	New Zealand Christmas Tree
Pinus eldarica	Mondell Pine
Pinus halepensis	Aleppo Pine
Pinus torreyana	Torrey Pine
Platanus acerifolia	London Plane Tree
Platanus racemosa	California Sycamore
Pyrus kawakamii	Evergreen Pear

Plant materials should be of good quality and meet marketable merchandise standards. Trees should exhibit a trunk caliper adequate to support their foliage crowns. Shrubs should exhibit a balanced and uniform growth pattern. Ground cover rooted cuttings should be **healthy**, vigorous, and well-rooted.

Generally, low-maintenance plants should be used on slopes and in common areas. An emphasis should be placed on color. Using plants' with invasive and shallow root systems should be avoided in such areas. Also, plants with fruit that will stain paving or autos should be avoided.

The spacing of trees and shrubs should be appropriate to the species used. The plant materials should also be spaced so that they do not interfere with the adequate lighting of the premises or restrict access to emergency apparatus, such as fire hydrants or fire alarm boxes. Proper spacing should also ensure unobstructed access for vehicles and pedestrians. The selection and placement of plants should take into consideration sight distance criteria for motorists, particularly at intersections along the collector loop road.

The use of "specimen" size trees is encouraged at special areas, such as building entrances, parkway entrances, and focal points. No specimen tree should be smaller than a 24-inch box in size. Shrubs should be 1 gallon size or larger.

4.5b Landscape Maintenance

All planting areas should be maintained in a weed- and debris-free condition. Walkways should be kept clear of debris from maintenance operations, erosion runoff from storms and irrigation, and windblown debris.

The irrigation system should be a permanent automatic underground system, programmed to deliver adequate soil moisture as determined by close personal inspection. The soil moisture attained should promote vigorous growth of all plant materials. The system should be maintained in good working order. Cleaning and adjustment to the system should be a part of regular maintenance activities.

All landscape catch basins, swales, channels, and other drainage devices should be maintained in a state conducive to conducting water in a free-flowing condition.

4.5c Fencing

All fences and walls should be designed as integral elements of building architecture or complementary to the

architecture and landscape character. Fencing **will** be subject to the Planning **Director's** approval as to materials, **color**, and height.

The following materials should be prohibited for use in **walls** or **fences**:

- Corrugated metal and plastic.
- Fiberglass panels.
- Mica plaster.
- **Unpainted**, brightly polished metals.

Plant materials should be used to soften the appearance of all walls and fences.

4.6 Conservation Practices

Conservation guidelines for Unit Three are based on the following objectives:

- Consider energy conservation in the design and development of projects.
- Promote water conservation in building design and landscaping.
- Preserve the natural open space area in its native state.

A conservation ethic is proposed whereby conservation concerns are considered in both project design and **construction**, and also long-term usage and maintenance. This ethic should apply to public facilities, to private developments, and to natural open space preservation.

4.6a Energy Conservation

For energy **conservation**, site planning should maximize the opportunities to utilize active and passive solar systems. Pertinent site factors include lot size; lot orientation in **relation** to sun and breezes; and solar access in regard to slopes, landscaping, and buildings. All proposed projects should address solar energy issues as required by the City, in accordance with the State Subdivision Map Act, Section 66473.1.

Building design should incorporate energy conservation practices to the extent feasible. This includes the design and construction of heating-ventilating and air conditioning systems; water heating; window treatments; insulation and **weatherstripping**; and lighting. Building design and equipment selection should consider life cycle costs rather than short-term capital and installation costs. Where practical, buildings ought to **be** sited and landscaped or provided with roof orientations according to passive solar energy concepts. **Energy-related** equipment should be an integral part of the **original** design concept for a facility or project. At the **minimum**, housing should be constructed to accept future solar water heating installations; and solar water heating systems should be utilized for swimming pools contained within attached housing projects.

In addition, the role of landscaping in energy conservation should be recognized. Plant materials should be

utilized to control exterior radiation and to reduce glare. Deciduous trees with dense foliage are recommended on the south and west faces of **buildings**, to intercept radiation before it strikes or after it is reflected. To lessen the intensity of the heat and light reflected from paving or **sidewalks**, vines growing up on a building wall or a ground cover should be utilized as a buffer against solar radiation. In combination with **shrubs**, these will aid in the reduction of summer glare and also help to moderate evening and winter cool spells.

It should be noted that the circulation system for the neighborhood contributes to energy conservation. Use of alternatives to the private automobile is encouraged by providing convenient bicycle and pedestrian routes and by accommodating public transit.

4.6b Water Conservation

Water conservation should be considered in the selection of mechanical equipment and plumbing fixtures. Emphasis should be placed on devices and design characterized by low water requirements and efficient utilization of water.

In addition, landscape design and choice of plant materials should emphasize low water requirements and minimize water runoff. Landscape watering systems should supply water efficiently, minimizing waste.

4.6c Natural Open Space Preservation

During design, construction, and maintenance of developments, areas designated as natural open space should be left as intact as possible. Dumping of fill should be minimized, and trampling of vegetation underfoot and by vehicles should not be permitted. Control measures may include signing, fencing, and close supervision of construction.

To control the use of off-road vehicles and limit undesirable foot travel, appropriate design **layouts**, signing, and landscaping should be employed at the view overlook and in developments along the open space area. The public overlook will include nature trails which provide visual access and limited physical access to the natural open space preserve (see Section **4.8c**).

4.7 Community Interface

The design approach to the interface between Unit Three and the surrounding community is based on the following objectives:

- Visually and physically buffer residential development from traffic impacts.
- Design the perimeter of the neighborhood to contribute to the overall aesthetic effect of the community, yet be compatible with the **neighborhood**.
- Provide identifiable neighborhood entrances into Unit, Three from the perimeter streets.

The overall interface concept calls for careful treatment of the transitions between the precise plan area and the perimeter streets and freeway. These transitions consist of slope **banks**, edges and fences at the tops of slopes, and, in the case of the perimeter arterial streets, street rights-of-way, medians, and neighborhood entrances.

4.7a Perimeter Arterial Streets

The rights-of-way and **adjacent** slopes for Del Mar Heights Road and El Camino Real should receive a design treatment similar to that of other community-oriented streets. Design treatments should be coordinated with the interior of Unit Three and with the Employment Center and the residential development unit to the east. Design solutions should visually edit out traffic and mitigate traffic noise to the extent feasible.

A parkway effect is desired, utilizing extensive landscaping of medians, sidewalk areas, slopes, and edges at the tops of slopes. A pleasing aesthetic experience should be provided to motorists, transit passengers, bicyclists, and pedestrians as they move along the arterial streets and paths. In addition, the design of the perimeter roadways should support the parkway character created in the interior of the Unit Three plan area.

Figure 20 illustrates the design treatment of perimeter streets. Adjacent projects should be coordinated with the arterial parkways to maintain visual continuity. A meandering natural look of tree placement is desired. Shrubs should be massed at the toe of the slopes along the parkway to mask transitional grading areas. Tree placement on slopes should favor the toe and middle areas of slopes. Plant materials in

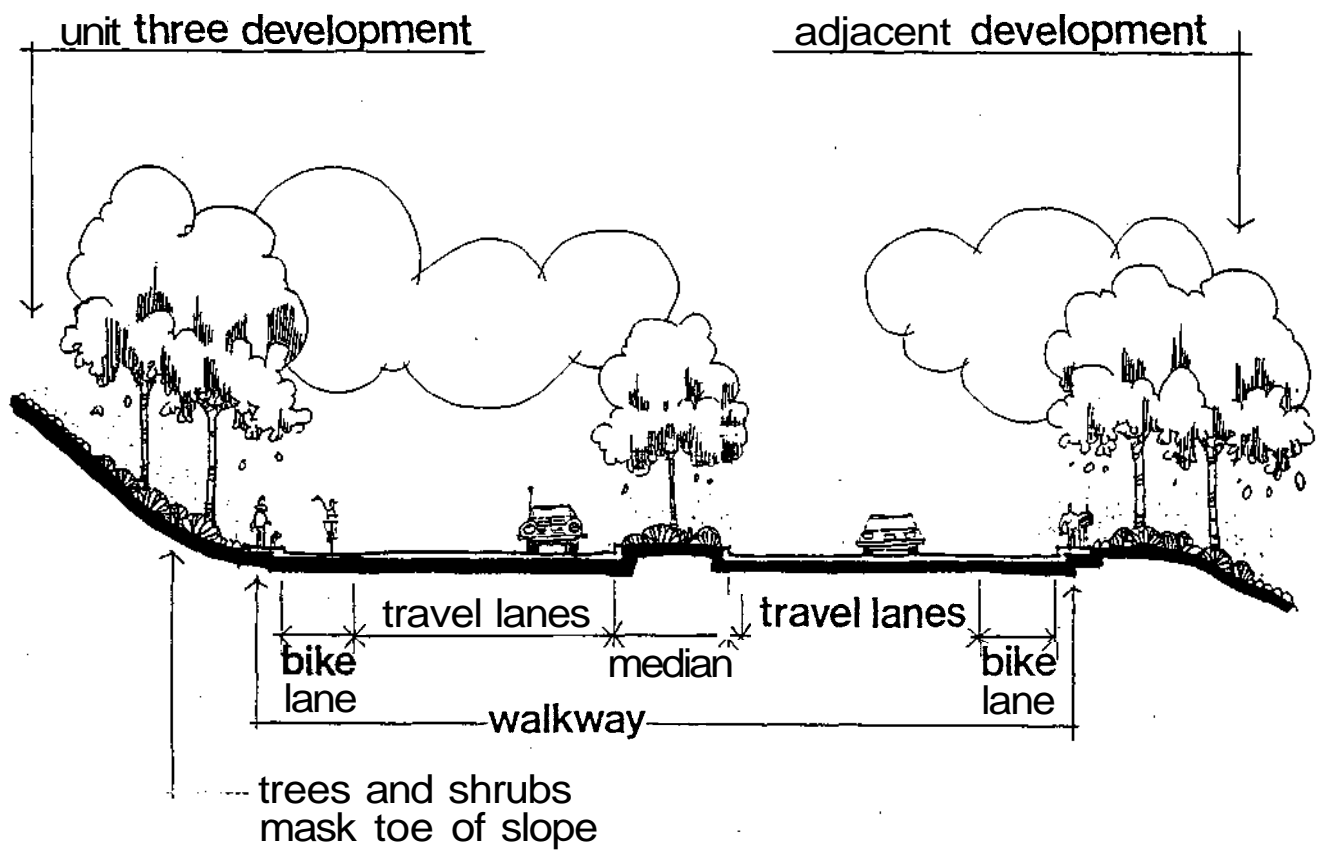

project areas along the top edges of slopes should frame or mask views from and to the residential areas as appropriate. Suggested primary trees are as follows:

Medians: Large-scale deciduous trees such as Platanus acerifolia (London Plane Tree) or Liquidambar styraciflua (Sweet Gum).

Parkway: Large-scale evergreen trees such as Pinus torreyana (Torrey Pine), Pinus eldarica (Mondell Pine), or Pinus halepensis (Aleppo Pine).

Other trees may be selected from the Recommended Tree List (Table 4). Landscaping of project edges should be adapted to the perimeter arterial treatment.

Pedestrians are provided a walkway along both sides of the parkways. Enriched paving is encouraged for pedestrian walks. Wheelchair ramps and other provisions for handicapped persons should be provided as required by the State of California and/or City or County of San Diego. Transit stops should be integrated into the pedestrian walks and include attractive **seating**, signing, and lighting. Bikeways are integral with the streets.

All furnishings, including signs, benches, fences, and lighting fixtures, should be selected or designed and constructed according to the design and safety standards of the City of San Diego. Repetition in material, color, and motifs or styles is desirable, to create a sense of continuity. Any fencing along the tops of slopes should be homogenous for the length of the slope.

Noise impacts resulting from projected traffic volumes along Del Mar Heights Road and El Camino Real should be mitigated to acceptable levels for residential and commercial uses. A noise analysis will determine the need for mitigation measures for individual development projects, as part of the environmental review process. Possible measures may include:

- Elevating development above the arterials, as is proposed.
- Providing a berm, a solid wall, or a combination **berm** and wall along the tops of slopes.
- Building only one-story structures next to the arterial or structurally insulating the upper floors of two- and three-story structures adjacent to the arterial.

- Designating a buffer zone between the arterial and any structures to attenuate noise.

4.7b Neighborhood Entrances

There are two entrances to the Unit Three neighborhood: the primary entrance from Del Mar Heights Road and the northern El **Camino** Real entrance. These entrances serve several functions:

- Provide an aesthetic and functional transition between the community arterials and the collector street parkway.
- Provide neighborhood **identification** along the arterials.
- Provide an entry and exit experience for those entering and leaving the neighborhood.

As illustrated in Figure 21, the entrances should reflect the parkway character intended for the arterial and collector street system. A deep setback of lawn should be provided. Tree groves should be held back a significant distance from entry corners to emphasize a broad open character and to create a sense of **spaciousness**. **Similarly**, buildings should be held back from the edges of the tops of slopes in order to retain the open entry feeling. There should be continuity between the landscaping at the **entrances** and the treatment in the arterial and neighborhood parkways. Like the parkways, the primary tree should be a large-scale evergreen tree such as *Pinus torreyana* (**Torrey Pine**), *Pinus eldarica* (**Mondell Pine**), or *Pinus halepensis* (**Aleppo Pine**). Other approved trees may be selected from the Recommended Tree List (Table 4).

While set back from the entrances by turning pockets, the street medians should be considered in entrance design. The primary tree for the street medians should be a large-scale deciduous tree such as *Platanus acerifolia* (London Plane Tree) or *Liquidambar styraciflua* (**Sweet Gum**). Other approved trees may be selected from the Recommended Tree List (Table 4).

Signage should be designed to fit into the landscape theme of rolling slopes and tree groves. Signs should be limited in overall height and be front-lighted using a wash effect. The entrance illumination should be coordinated to provide a hierarchy of light **quality** and intensity. Emphasis should be placed on areas of high vehicular and

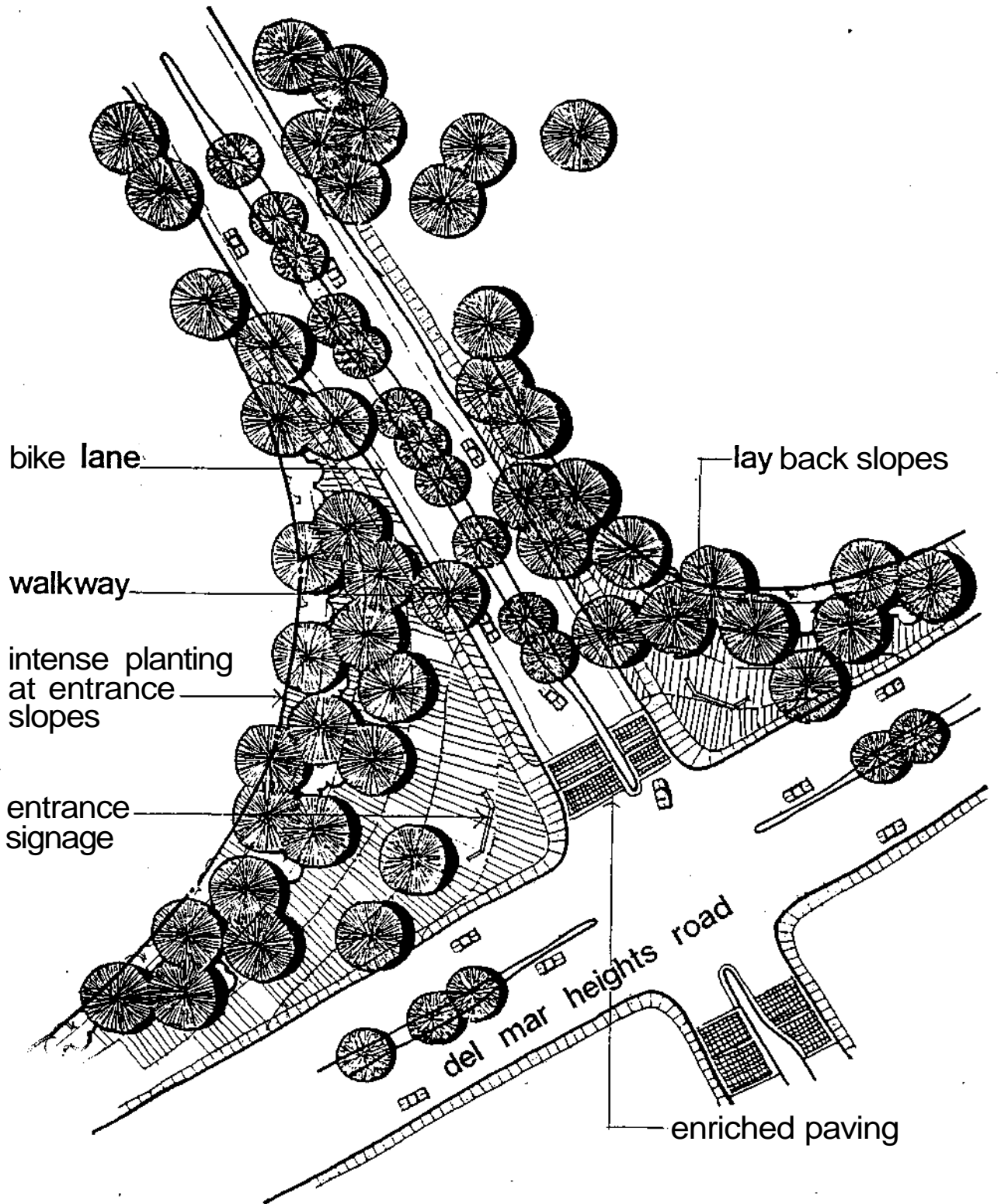

pedestrian activity through increased light intensity at those areas. A gradual reduction of light intensity between major areas of activity should provide the desired modulation of light without sacrificing safety and utility.

Pedestrian paths will be provided on both sides of the **street** and should be integrated into the entrance treatment. Sidewalks may be of enriched texture or color to aid in creating the desired parklike effect. Wheelchair ramps and other provisions for handicapped persons should be provided as **required** by the State of California and/or the City or County of San Diego.

4.7c Freeway Buffer.

The freeway buffer along the western side of the precise plan area serves several purposes:

- Beautifies an existing slope visible to motorists along Interstate 5 and residents in Del Mar Heights.
- Provides visual editing of the westward views and noise buffering for residences along the freeway.
- Contributes to creating an attractive community entrance at the Del Mar Heights Road interchange.

As shown in Figure 22, a landscaping program for the freeway embankment is proposed. A refined native look is desired for this area, with tree groves producing a natural meandering effect. The slopes should be intensely planted in tree groves and shrub massing. Trees at the tops of the slopes should frame or screen views as appropriate from Unit Three residential areas.

At the southwest corner of the precise plan area, the proposed slope is laid back and contoured to produce an open entry **effect**. A **berm** at the top of the slope will provide a noise and visual buffer for the adjacent attached residential area. Landscaping should be continuous with the embankment paralleling the freeway. The slope should be intensely planted in tree groves and shrub massing.

The primary tree for the freeway area should be a **large-scale** evergreen tree such as *Pinus torreyana* (**Torrey Pine**), *Pinus eldarica* (**Mondell Pine**), or *Pinus halepensis* (**Aleppo Pine**). This ensures some continuity with the Del Mar Heights Road parkway. Additional trees may be selected from the Recommended Tree List (Table 4).

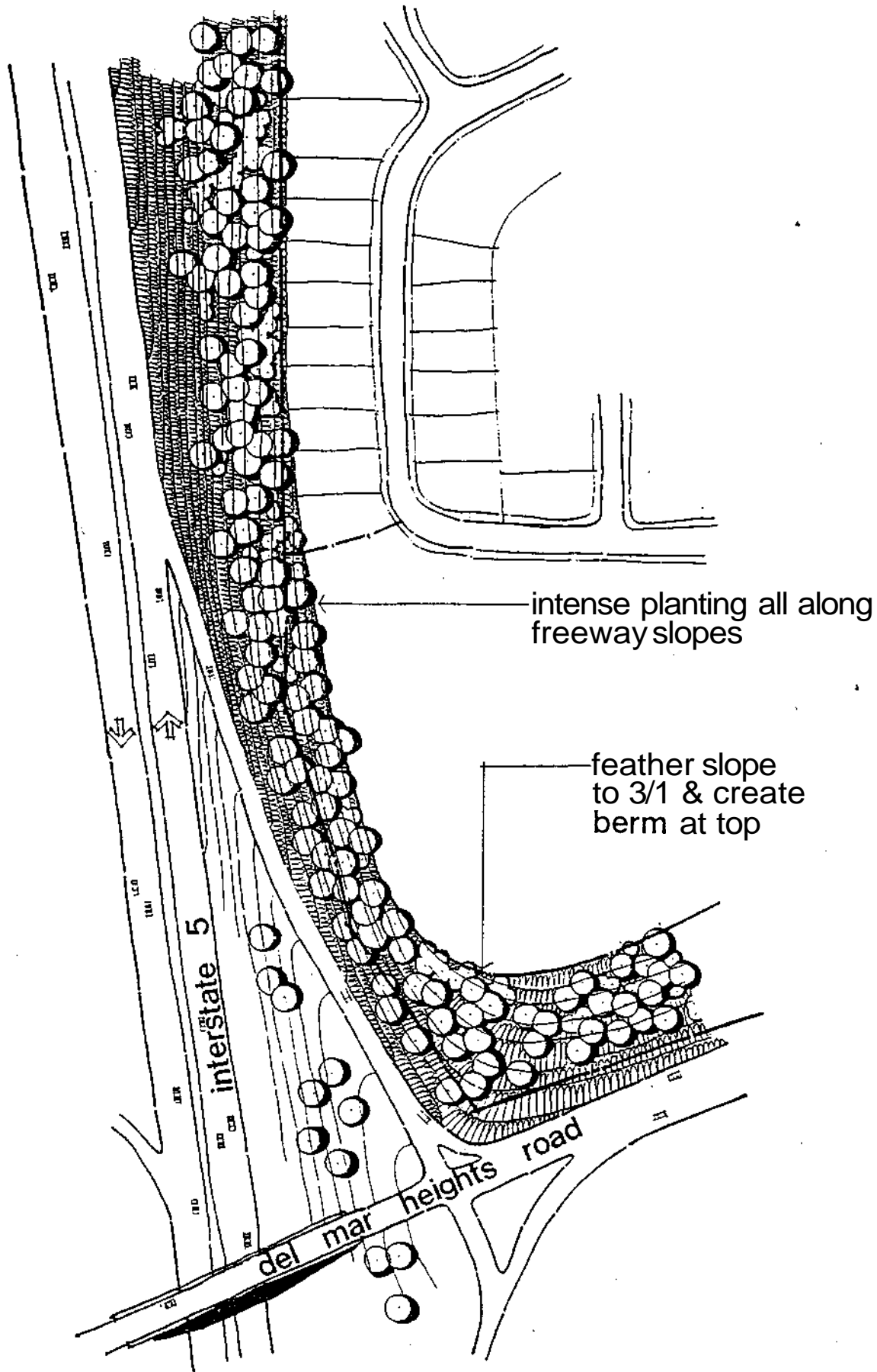

FREWAY BUFFER

Noise impacts resulting from projected traffic volumes along Interstate 5 and the Interstate 5/Del Mar Heights Road interchange should be mitigated to acceptable residential levels. A noise analysis will determine the need for mitigation measures for individual development projects, as part of the environmental review process. Possible measures may include:

- Elevating development above the freeway, as is **proposed**.
- Providing a **berm**, a solid wall, or a combination **berm** and wall along the tops of slopes.
- Building only one-story units next to the freeway or structurally insulating the upper floors of two- and three-story units adjacent to the freeway.
- Designating a buffer zone between the freeway and any dwelling units to attenuate noise.

4.7d Northeastern Slope

A major slope is proposed along the northern portion of El Camino Real, below the detached residential theater lots. This slope area is a designated "developed" open space as described in Section 2.6. A 4:1 gradient and contoured grading are proposed, blending into the natural terrain to the north. Treatment of the northeastern slope is illustrated in Figure 23.

A natural appearance is desired in this open space area. The landscaping should provide a transition between the developed areas and the natural open space preserve. Hydro-seeding is proposed, and a native mix of shrubs and ground covers is recommended. Specific Landscape Site Component Standards for Subzones should be consulted for requirements and plant spacing and size on slope areas.

The primary tree for the slopes should be a large-scale open-headed evergreen tree such as Eucalyptus cladocalyx (Sugar Gum) or Eucalyptus sideroxylon (Red Ironbark). Other suggested trees are listed in the Recommended Tree List (Table 4). All tree planting should preserve views from the theater lots.

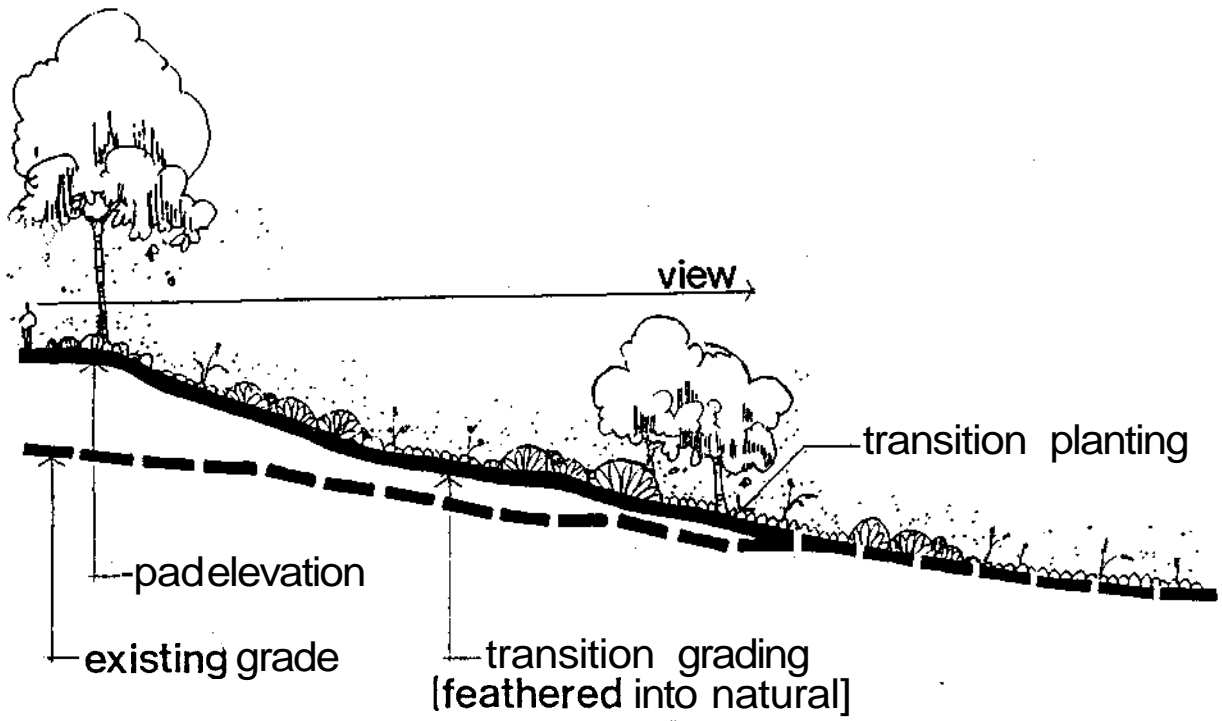

contour grading

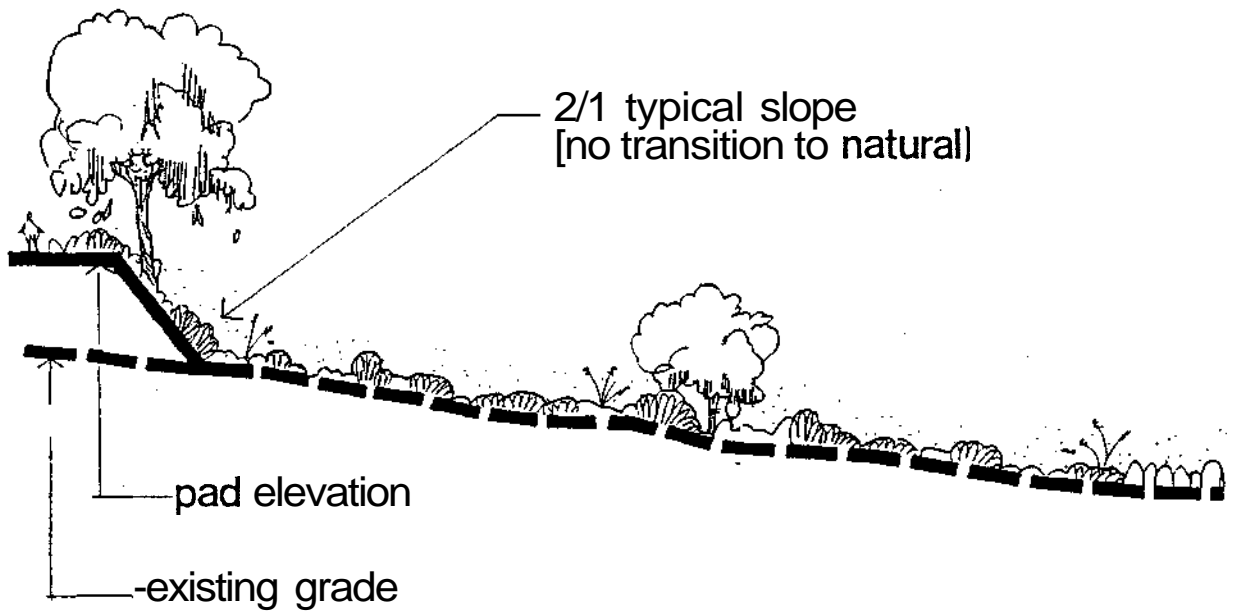

typical slope bank

4.8 Collector Street Parkway

The design approach to the collector streetscape within Unit Three is based on the following objectives:

- Create an enjoyable streetscape for those traveling the **collector** parkway.
- Develop identifiable entrances into each residential project and neighborhood facility.
- Provide for efficient and safe **automobile**, bicycle, and pedestrian travel within the parkway.
- Complement adjacent projects and facilities both functionally and aesthetically.

A parkway concept is **proposed**, which provides for multi-modal travel within an attractively designed street right-of-way. Internal and external views are provided along the length of the parkway. For parkway street sections, see Figure 15.

4.8a Parkway Design Treatment

A parkway effect should be developed within the collector street right-of-way, supplemented by landscaping in adjacent projects and facilities. The internal collector loop is planned to gently meander through the **neighborhood**, with three connections to the neighborhood entrances. A parklike appearance should be experienced continuously along the collectors by coordinating landscaping and other design features along the entire **right-of-way**. **"T"** intersections where collector connections from the neighborhood entrances meet the interior collector loop should provide pleasant vistas for those traveling in the neighborhood.

Figures 24 and 25 exemplify several conditions along the parkways. Pedestrian walkways should parallel the roadway at the neighborhood entrances, along neighborhood facilities, and next to major slopes. The sidewalk may abut the curb along the school site because of City standards or school **district requirements**. In other locations, valuable walkways within the right-of-way may be provided if feasible. Walkways may be textured or colored to reinforce the **"parklike"** character of the parkway. Any transit stops should be integrated into the pedestrian walks. Marked bikeways are integral with the street.

The entire area between street curb and the project setback line should be landscaped except for vehicle access

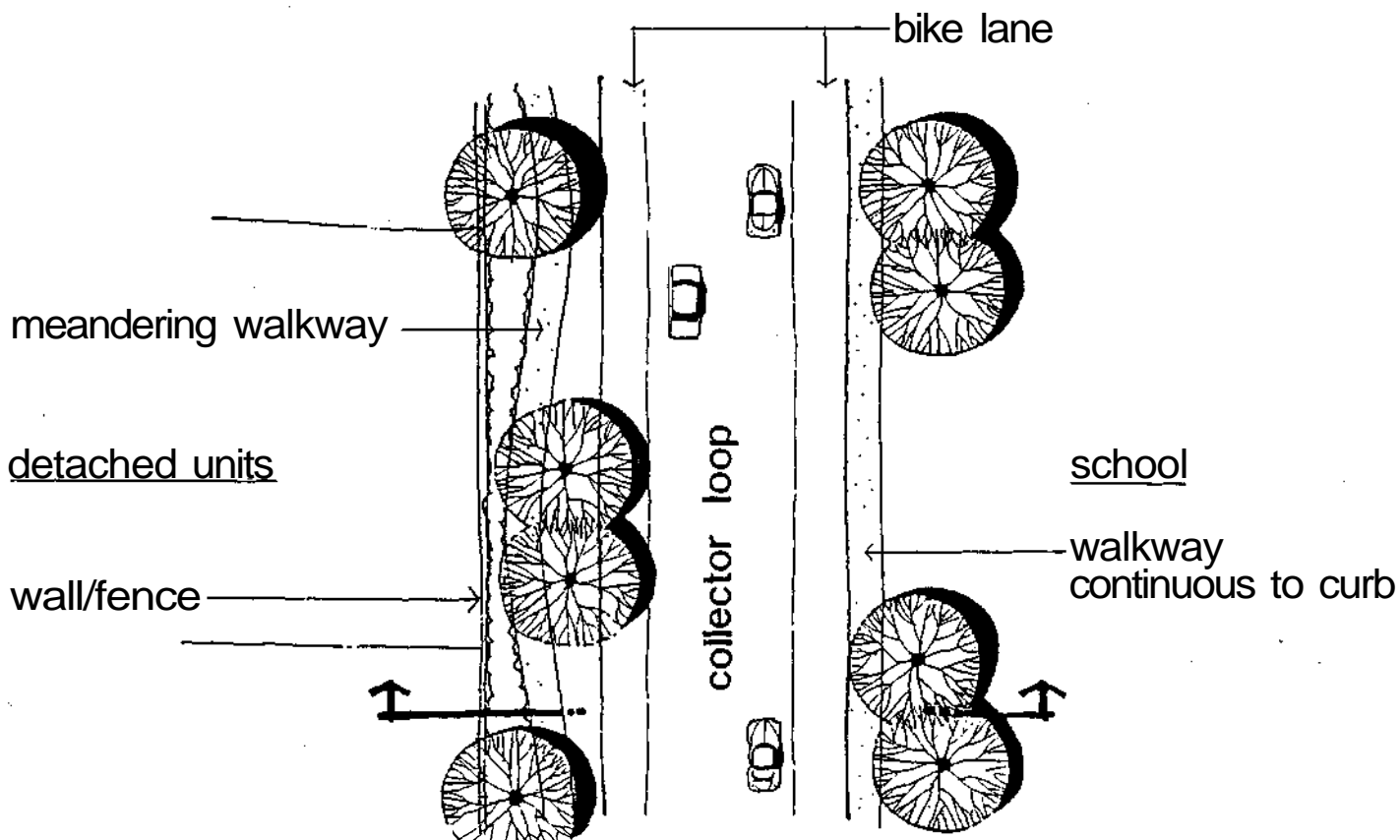
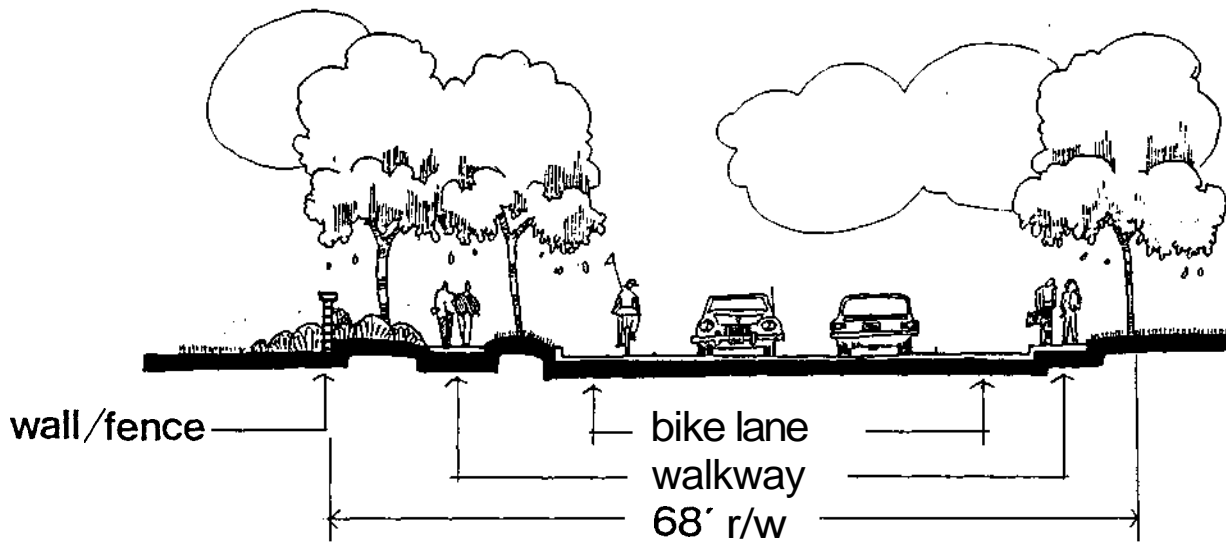

**PARKWAY FLAT CONDITION
COLLECTOR LOOP**

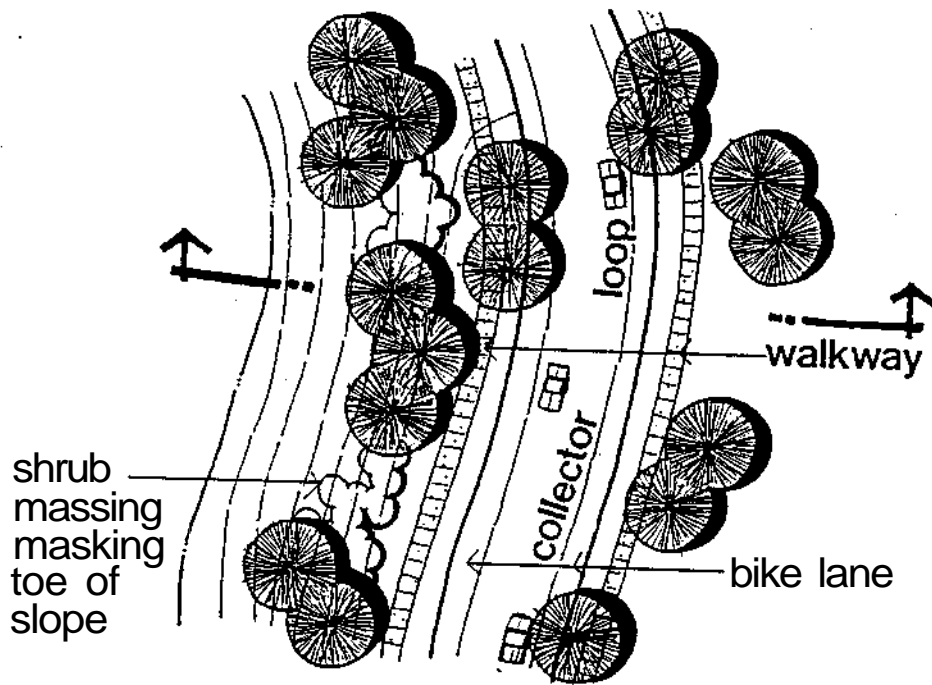
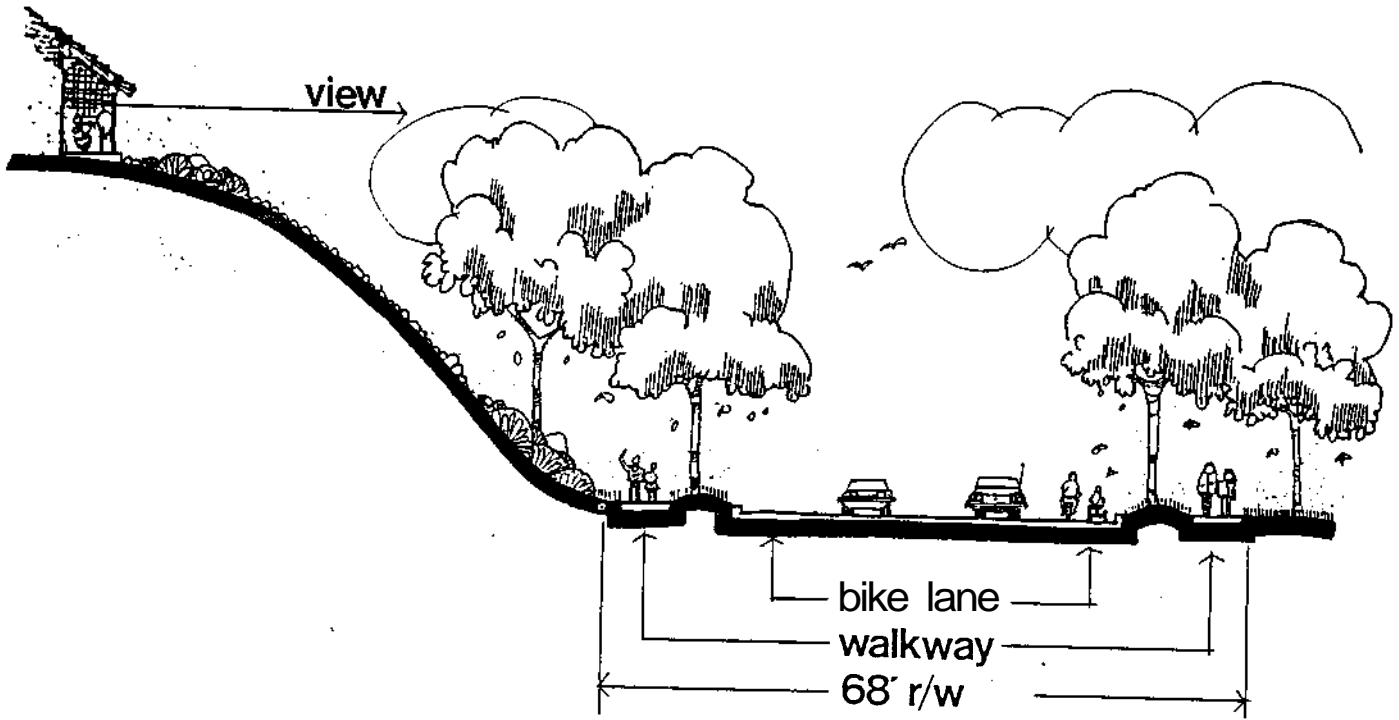

PARKWAY SLOPE CONDITION
COLLECTOR LOOP

driveways and pedestrian paths. Lawn should occupy a significant percentage of landscape devoted to parkway planting, including a significant percentage of **mowable** slopes. Planting and grading should create a variety of depths. A meandering natural look of tree groves is desired. In areas with slopes, shrubs should be massed at the toe of slopes to mask transitional grading areas. Tree placement on slopes should favor the toe and middle areas of slopes. Primary trees should be as follows:

Parkway: Large-scale evergreen trees such as Pinus torreyana (Torrey Pine), Pinus eldarica (Mondell Pine), or Pinus halepensis (Aleppo Pine).

Slope areas: Large-scale, open-headed evergreen trees such as Eucalyptus cladocalyx (Sugar Gum) or Eucalyptus sideroxylon (Red Ironbark).

Other trees may be selected and substituted for the above from the Recommended Tree List (Table 4).

Lighting for the parkway should be coordinated to provide a hierarchy of light quality and intensity. Emphasis should be placed on areas of high vehicular and pedestrian activity through increased light intensity at those areas. A gradual reduction of light intensity between major points of activity will provide the desired modulation of light without sacrificing safety and utility. This should be typical throughout the parkway.

All furnishings, including signs, benches, fences, and lighting fixtures, should be selected or designed and constructed according to the design and safety standards of the City of San Diego. These features should complement both the parkway landscape design and the architecture of neighborhood facilities. Repetition in materials, colors, and motifs or styles is desirable to create a sense of continuity. Any fencing along the tops of slopes should be homogenous for the length of the slope.

For a discussion of the neighborhood entrances, see Section 4.7b. Entrances to residential projects along the parkway are discussed in Sections 4.9 and 4.10.

4.8b Embellishment Features

As shown in Figure 17, five embellishment features are called for along the collector loop parkway. These features serve the following purposes:

- Provide a repeated, distinctive design feature within the parkway, adding unity in design.
- Heighten the visual focus on public facilities: the school, the park, and the view overlook.
- ® Ensure visual continuity in the bicycle and pedestrian networks where they intersect the street system.

Figure 26 illustrates a typical embellishment feature, in this case where the interior loop meets a collector connection to a neighborhood entrance. Enriched paving within the roadway could consist of textured or contrasting pavement material, for example. For adjacent areas where bikeways and pedestrian paths merge, gentle ramps must be provided when required by grade differences. All work should conform to the City of San Diego standards, including paving skid **requirements**. Wheelchair ramps for handicapped persons should be provided as required.

Landscaping elements should heighten the embellishment features as visual focal points. For **"T" intersections**, views from the leg of the "T" across the intersection should be well designed and articulated by landscaping. This is particularly important for the designated **"developed"** open space west of the school, located at the end of a cul-de-sac. Trees should be held back at the crossings and lawn should occupy a significant percentage of landscape devoted to parkway planting. For a discussion of suggested trees, see Section **4.8a**.

4.8c Public View Overlook

As depicted in Figure 12, an expansive view overlook is provided along the northwest portion of the interior collector loop of the parkway. The overlook encourages public viewing of the ocean to the northwest and San **Dieguito** River valley to the north from pedestrian paths. It also permits viewing by motorists and bicyclists as they travel along the **parkway**.

Within the public overlook area of the parkway, the **pedestrian** path on the north side moves away from the parkway towards the lookout areas. This walkway should meander through the area, with breaks in the planting areas where nature trails meet the walk. Figure 27 illustrates this concept. The nature trails and lookouts should be of a non-erosive material, but not be as permanent in appearance as

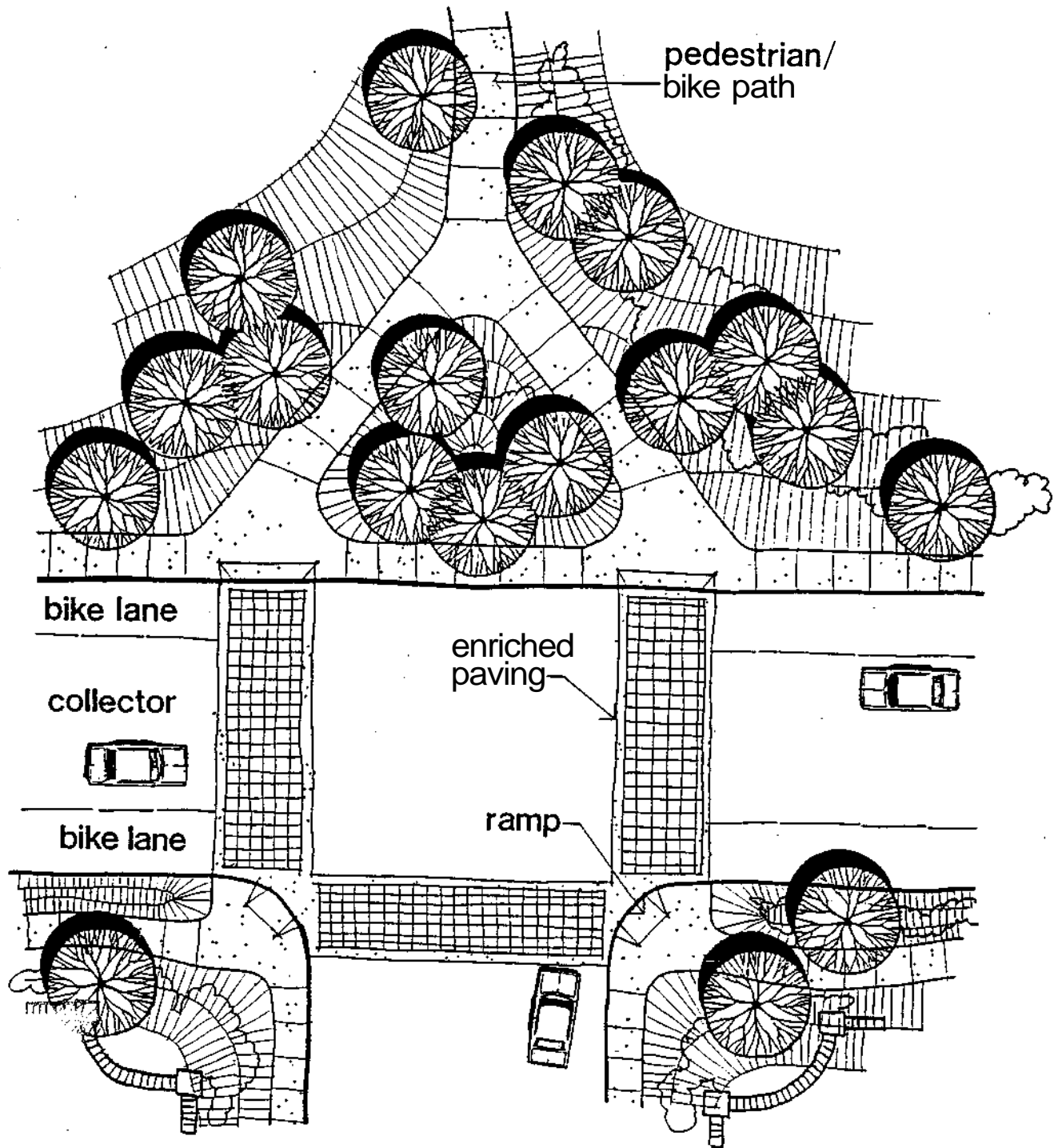

PARKWAY EMBELLISHMENT FEATURE
COLLECTOR LOOP

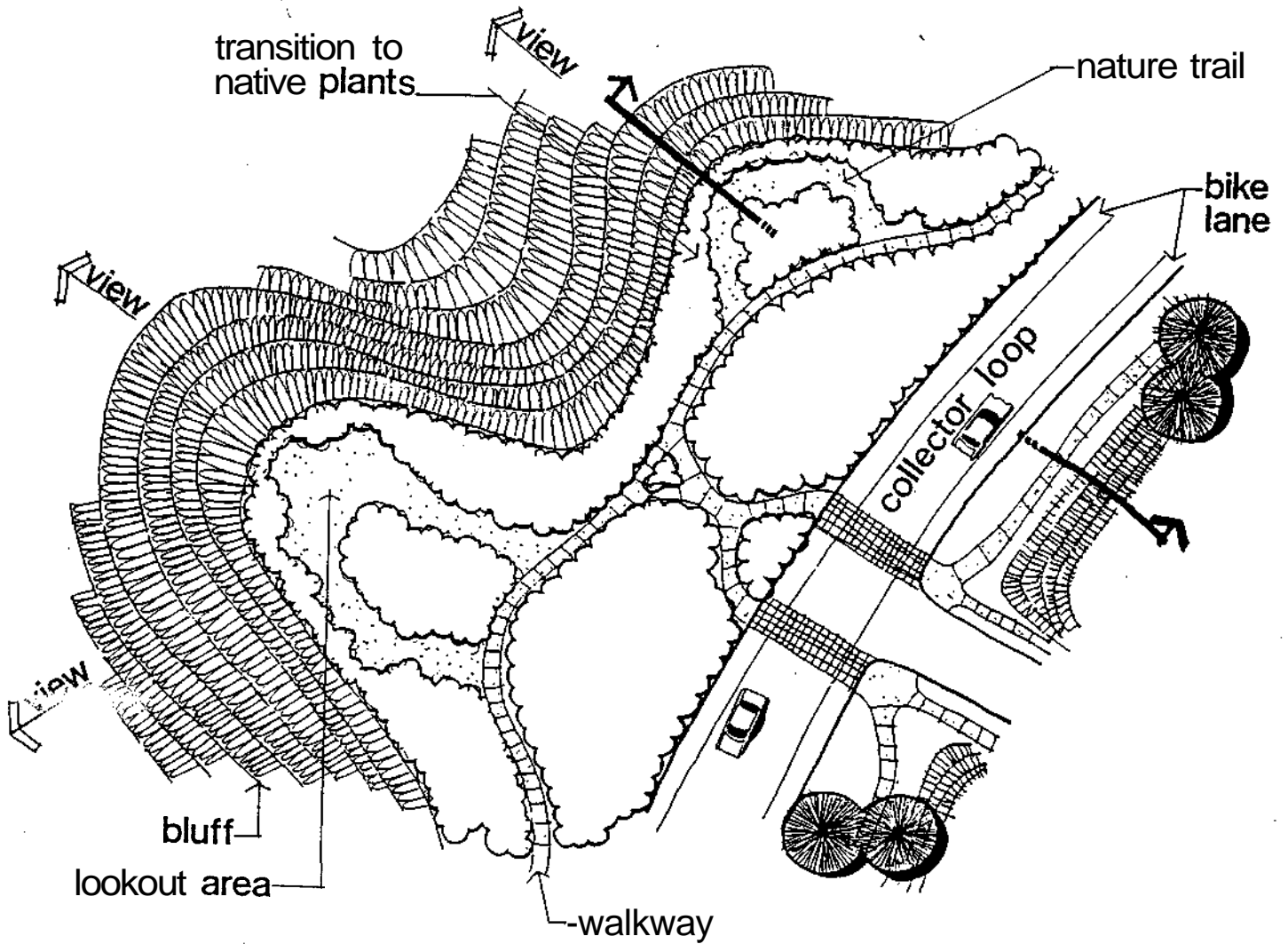
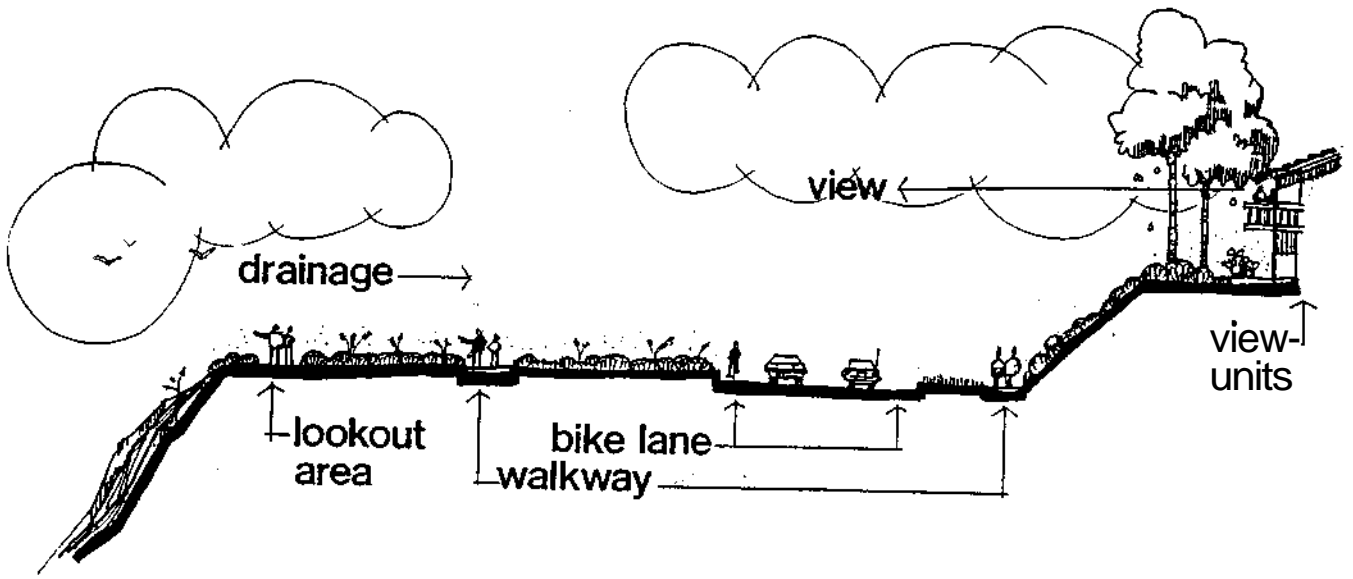

PARKWAY VIEW OVERLOOK
COLLECTOR LOOP

the paving of the pedestrian path. An embellishment feature where a project road intersects the collector loop should tie the overlook paths to the attached residential **project** to the **south**.

It is imperative that the view across the overlook area be maintained. Low native shrubs and ground cover should be **utilized** to reinforce the natural appearance of the lookout. Overall, a refined native look is desired. The landscaping at the bluff edges should provide a transition to the native flora. No runoff down the bluffs should be permitted.

Benches in the lookout areas should be selected or designed to complement the natural landscaping concept. They should conform to City standards.

4.9 Detached Residential Projects

The following objectives provide the basis for the detached housing design guidelines:

- Maximize view **opportunities**.
- Create project identity while contributing to the overall character of the Unit Three **neighborhood**.
- Provide attractive yet functional circulation and parking.

The locations of detached **single-family** housing are shown in Figure 6. A total of 289 units are provided on two types of lots: conventional lots in the southwest, **central**, and northeast areas and theater lots in the far northeast area.

4.9a Development Regulations

All single-family projects should be developed in conformance with the Single-Family (SF 1-A) **Zone**, as described in Section 5.1 and incorporated into the Planned District Ordinance. The permitted uses, density regulations, and parking regulations of the **City's R-1** Zone will apply to this zone. The development regulations will include the following:

- The minimum lot size should be 5,500 square feet, with the following minimum dimensions in linear feet:

Street Frontage	50
Interior Width	50
- The following minimum yard dimensions in linear feet should apply:

Front Yard--Residence	10
--Garage	15
Side Yard --Street	10
--Interior	4
Rear Yard	4
- No buildings should cover more than 60 percent of the lot.
- No building should be constructed, altered, or enlarged to a height greater than thirty-five feet.

4.9b Design Treatment

In addition to the above, the following guidelines should be considered in designing single-family projects:

- Site planning should emphasize view enhancement from each dwelling unit.
- Each project area should be given an identity through common design **treatments**, delineation of project boundaries, and distinctive entrances.
- The design of buildings, fencing, and street hardscape should be coordinated to create an overall project atmosphere or style, while permitting a variety of floor plans and individuality in unit exteriors and yards. Scale, colors, materials, and architectural style should be similar throughout each **project**.
- The utilization of the principles of crime preventive design and defensible space should be encouraged.

The use of a selected landscape palette should be encouraged, particularly along streets, at project entrances, and on slopes visible to the public. The purpose is to give a sense of project continuity while being compatible with the neighborhood as a whole. The primary tree suggested for the project entrances at the collector street parkway should be a large-scale evergreen tree such as Pinus torreyana (Torrey Pine), Pinus eldarica (Mondell Pine), or Pinus halepensis (Aleppo Pine). The primary slope tree should be a large-scale open-headed evergreen tree such as Eucalyptus cladocalyx (Sugar Gum) or Eucalyptus sideroxylon (Red Ironbark). Other suggested trees are cited in the Recommended Tree List (Table 4).

4.9c Conventional Lots

Conventional lots will be sited on double-loaded local streets and cul-de-sacs. Typical street sections are shown in Figure 16. The streets should be curvilinear to avoid visual monotony. For the project areas next to the freeway and in the center of the plan **area**, there are only two project entrances; these entrances should be distinctively designed.

Project entrances, designated "developed" open space areas, major perimeter slopes, and other open spaces with neighborhood/community visibility will be preserved and

maintained as described in Table 3. Additional open space areas within the projects will be lotted out and maintained by individual owners. Design treatment of lots at the perimeter of projects should consider the interface with community and neighborhood elements (such as the collector street or **kway**, freeway buffer, natural open space, power easement, and school and park) and with other residential projects.

4.9d Theater Lots

In the northeast corner of the precise plan area, residential theater lots are proposed along single-loaded cul-de-sacs. A typical street section is shown in Figure 16. This development concept has been selected in this sloping area to minimize grading and maximize views, while contributing to the **rural** character of the San Dieguito River valley.

Open space areas within this area should be lotted out to individual owners and maintained by a project homeowner association or maintenance district. This is to ensure uniform treatment and maintenance of the slopes. In order to maintain the views from each lot, tree placement is crucial. A majority of trees should be placed at the toes of the slopes to maintain views. Screening of the toes of slopes should be done with shrub massing. The slopes should appear natural with tree groves and shrub massing. Figure 28 illustrates the landscaping concept for theater lots.

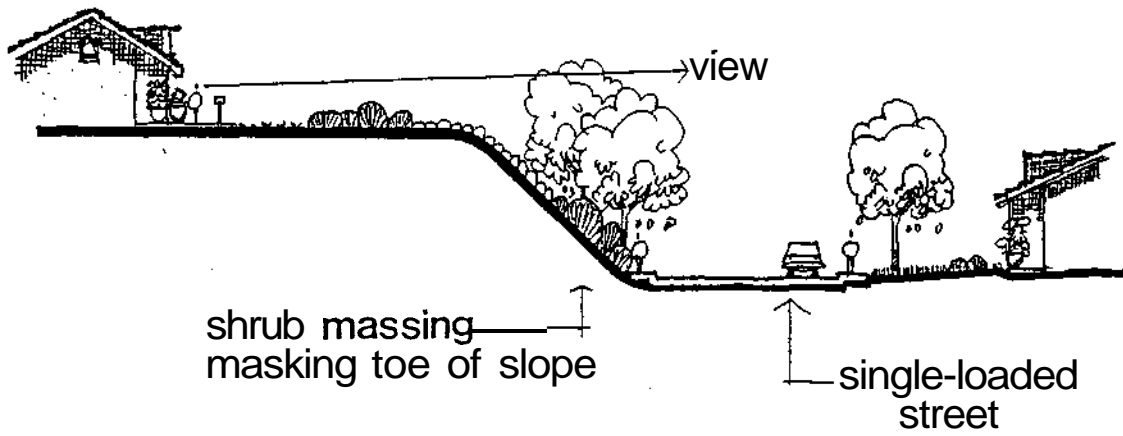

4.10 Attached Residential Project

The objectives listed below form the basis for the attached housing guidelines:

- Maximize view **opportunities**.
- Create project identity while contributing to the overall character of the Unit Three neighborhood.
- Provide attractive yet functional circulation and **parking**.
- Buffer housing from noise and traffic.
- Provide common areas, such as recreational facilities, clubrooms, and shared open space.

The locations of attached housing are depicted in Figure 6. A total of 910 dwelling units are provided in eight project areas of different densities.

4.10a Development Regulations

The attached housing projects should be developed in conformance with the Multiple-Family (MFL and MF1) Zones, as described in Section 5.1 and incorporated into the Planned District Ordinance. The permitted uses and signing, special regulations, minimum yard dimensions, landscaping requirements, and off-street parking regulations of the City's R-2 Zone will apply to these zones. The density and property development regulations will include the following:

- The density regulations below in dwelling units per acre should apply in multiple-family zones. Net acre should be defined as the site area excluding arterial and collector streets and designated "developed" open space.

Zone	Density Range
MFL	5 through 9
MF1	7 through 14

- The open space in **square** feet provided per dwelling unit on the property should not be less than that shown below:

Total Required Open Space	1,800
Required Usable Open Space	900

- Usable open space should not have an overall grade exceeding ten percent and should not be occupied by **buildings, streets, driveways, or parking areas.**
- No buildings should be constructed to a height greater than forty-five feet.

4.10b Design Treatment

Each project area should be given an identity through common design elements or treatments, delineation of project boundaries, distinctive entrances, and shared recreational areas or other focal points. The scale, colors, materials, design details, and architectural style of buildings and furnishings should be shared by the entire project. The principles of crime preventive design and defensible space should be employed in the design of projects.

A **selected** landscape palette should be utilized throughout each project. The purpose is to give continuity and unity to the project while ensuring **compatibility** with the overall neighborhood. Landscape treatment of project perimeters should consider the interface with community and neighborhood elements (such as the collector street parkway, freeway buffer, natural open space, power easement, school and park, and perimeter arterials) and with other residential projects. Private outdoor space in the form of private yards, patios, decks, and balconies should be provided for each unit and, where feasible, should enjoy good views. Suggested primary trees are as follows:

Project entrances at collector street parkway:

Large-scale evergreen trees such as Pinus torreyana (Torrey Pine), Pinus eldarica (Mondell Pine), or Pinus halepensis (Aleppo Pine).

Internal project slopes:

Large-scale open-headed evergreen trees such as Eucalyptus cladocalyx (Sugar Gum) or Eucalyptus sideroxylon (Red Ironbark).

Group parking areas:

Large-scale deciduous trees such as Platanus acerifolia (London Plane Tree) or Liquidambar styraciflua (Sweet Gum).

Other trees which may be substituted are cited in the Recommended Tree List (Table 4).

Project entrances should occur along the collector street parkway if possible. No project entrances are permitted along the perimeter arterials. Project roads should be curvilinear in **nature**, in order to slow traffic and to provide visual interest. There should be adequate **provision** for bicycle and pedestrian circulation within projects and linkages to the neighborhood bicycle and pedestrian path networks.

Parking bays should be small in size and screened where possible. Parking areas adjacent to another residential project or neighborhood facility should be screened by a wall or fence and landscaping, and lighting should minimize light spillover. Bicycle storage is suggested at common recreational areas and other shared facilities. Any common trash storage areas should be screened and should be conveniently located to the dwelling units and have easy access to pick-up service.

4.10c Project Types

Two site planning conditions can be identified: terraced or stepped up pads and large, relatively **flat** pads.

- The terraced or stepped up pad situation generally corresponds to lower density attached projects with extensive external view **opportunities**. Site planning should maximize view exposures by changing elevations, staggering buildings, clustering units, and other design measures. Housing products must be suitable to site conditions. Project slopes should be landscaped and maintained. Landscaping should frame or enhance **views**, not screen them.
- The flat pad situation generally corresponds to higher density attached projects with limited view **opportunities**. Site planning should emphasize creating attractive internal views within the project. Where feasible, areas with external view opportunities should be utilized for common spaces to **enhance** the entire project. Housing products should be well designed and scaled to create aesthetic interest. **Landscaping** should also be utilized to generate internal vistas and visual excitement.

4.11 School and Park

The following objectives provide the basis for the elementary school and neighborhood park design guidelines:

- Link the school and park facilities functionally and aesthetically; facilitate joint usage.
- Design facilities to reduce crime and vandalism and provide ease of maintenance.
- Provide adequate local access and parking for **autos**, paths and storage for bicycles, and walks and seating for pedestrians.
- Create school and park facilities as the focal point of the neighborhood.
- For the park, grade the site to retain the existing stand of Torrey Pines.

Design guidelines for the school and park are outlined below.

4.11a Elementary School

Figure 29 depicts a schematic plan for the school site. The following elements should be incorporated in the specific school site design:

- School building(s).
- Recreational/playground facilities.
- Automobile access and parking.
- Internal bicycle/pedestrian path (see Section 4.11c).
- Other pedestrian and bicycle access and bicycle storage.
- Features to assure provisions for "dropoffs" and "pickups" within the site.
- A landscaping screen abutting the power easement next to the attached residential (see Section 4.12), and landscaped slopes to buffer the school from adjacent residential projects.

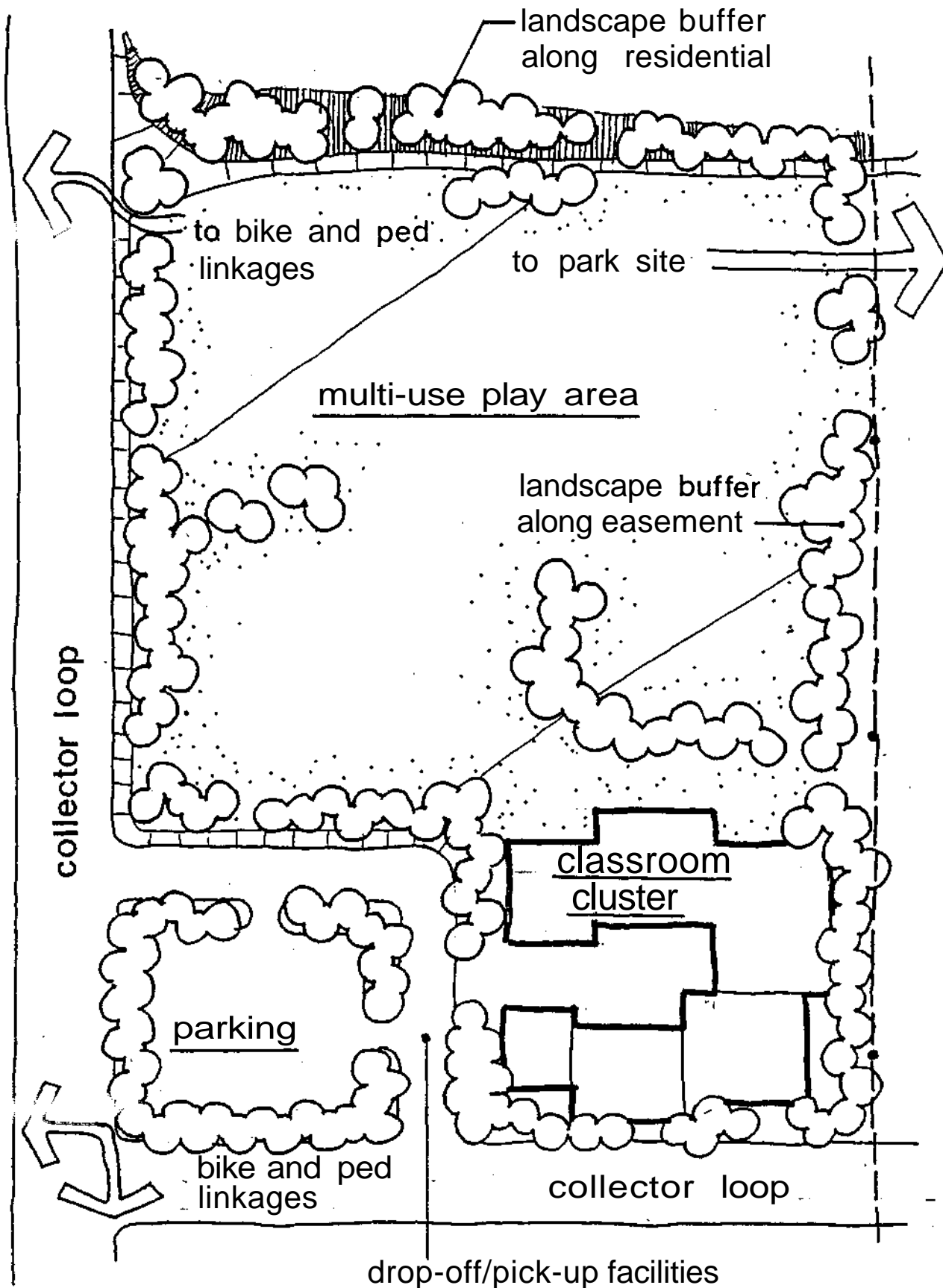

SCHOOL SCHEMATIC

The design and siting of all school facilities should take into account aesthetic impacts on students as well as on the surrounding community. An architectural style, building materials, and colors appropriate to the surrounding neighborhood should be utilized. Large, bulky, or sprawling buildings should be broken up by height changes, shadow relief, clustering, or similar measures. The design of landscaping and furnishings, such as light fixtures and signage, should complement that of the collector street parkway and neighborhood park.

The school should be designed to facilitate the use of meeting rooms and recreational facilities during off-session hours by the general public. The selection of recreational/playground facilities should be coordinated with those provided in the neighborhood park, in particular in regard to multipurpose courts and playfields. Unnecessary duplication of facilities should be avoided.

Particular care should be taken to design secure, safe school facilities. The principles of crime preventive design should be employed in planning the school. In addition, sound health and safety design standards should be followed. Sufficient lighting should be provided on the site to ensure safety and facilitate surveillance.

Safe access by students should be considered in the siting and design of the school facilities. Travel by bus, private car, bicycle, and foot should be considered in designing internal pick-up/drop-off points and parking areas.

A plant palette similar to that of the park and parkway should be utilized in order to bring coherence to the neighborhood. The following primary trees are suggested:

Next to the parkway: Large-scale evergreen trees such as Pinus torreyana (Torrey Pine), Pinus eldarica (Mondell Pine), or Pinus halepensis (Aleppo Pine).

Northern slope: Large-scale open-headed evergreen trees such as Eucalyptus cladocalyx (Sugar Gum) or Eucalyptus sideroxylon (Red Ironbark).

Parking area(s): Large-scale deciduous trees such as Platanus acerifolia (London Plane Tree) or Liquidambar styraciflua (Sweet Gum).

Other trees are cited in the Recommended Tree List (Table 4).

4.11b Neighborhood Park

Figure 30 illustrates a preliminary park study plan for the neighborhood park. The following elements ought to be included on the site:

- Active play areas, for example, multipurpose courts and open lawn.
- Passive play areas, such as seating or picnic areas.
- **Children's** apparatus area.
- Automobile access and parking.
- Internal bicycle/pedestrian path (see Section 4.11c).
- Other pedestrian and bicycle access and bicycle storage.
- Landscaped slopes to buffer the park from adjacent residential areas.
- Existing stand of Torrey Pines.
- Restrooms, if required.

The park should be planned with access and parking nearest the collector street, climbing eastward to a grouping of Torrey Pines to be preserved. The tree area should be utilized for passive recreation. The westernmost portion of the site is most adaptable to grading for active play areas. Planted slopes on the northern and southern sides of the site should act as a buffer to the adjacent residential areas.

Cross-connections between the park and school are encouraged. The internal bike/pedestrian path will provide a strong connection. As noted previously, the selection of recreational facilities should be coordinated with facilities at the school to avoid unnecessary duplication.

Park facilities should meet City health and safety standards and should be able to withstand vandalism. Creative design of the play facilities and apparatus is encouraged, while complementing the style, materials, and colors of the school facilities. The principles of crime preventive design should be employed, particularly the maintenance of views from the parkway into the park for surveillance purposes.

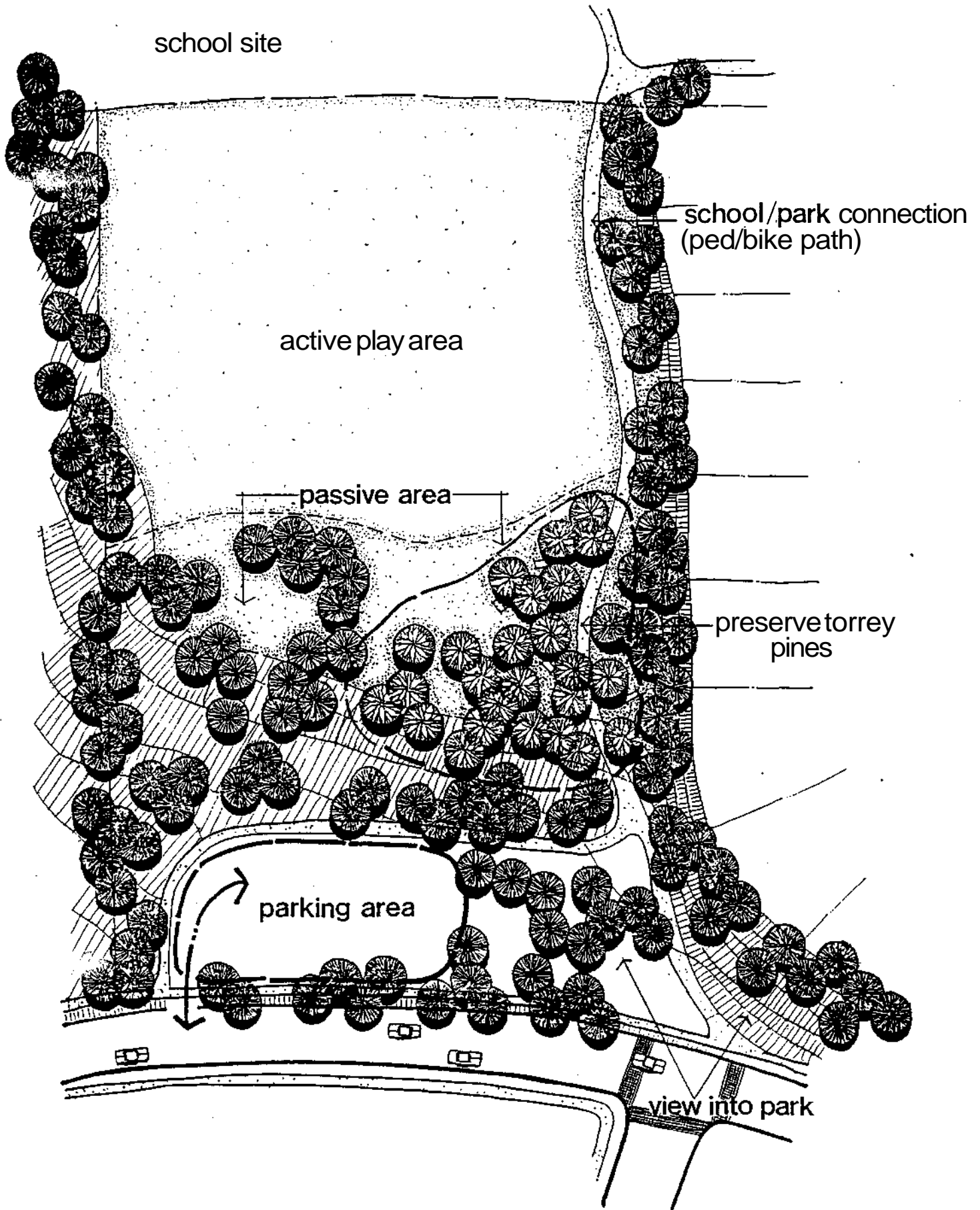

Adequate night lighting should be provided to ensure safety and facilitate **surveillance**.

Sufficient off-street parking for park users should be provided on the site. The parking area should not dominate the view to the park from the street. The entrance to the parking lot should be **emphasized** and the lot itself de-emphasized by screening it with trees.

The final plan for the neighborhood park site must be approved by the Northern Area Committee of the Park and Recreation Board, the Facilities **Committee**, and the Park and Recreation Board of the City of San Diego.

In order to lend coherence to the neighborhood facilities, a plant palette similar to that of the school and parkway should be utilized for the park. The following primary trees are recommended:

Next to the parkway: Large-scale evergreen trees such as *Pinus torreyana* (Torrey **Pine**), *Pinus eldarica* (Mondell **Pine**), or *Pinus halepensis* (Aleppo **Pine**).

Passive recreation area: Existing *Pinus torreyana* (Torrey **Pine**).

Northern slope and south perimeter: Large-scale, open-headed evergreen trees such as *Eucalyptus cladocalyx* (Sugar Gum) or *Eucalyptus sideroxylon* (Red Ironbark).

Additional trees are suggested in the Recommended Tree List (Table 4).

4.11c Internal Bike/Pedestrian Path

An internal bike/pedestrian path meanders along the northern side of the school and park, between the west and east portions of the collector loop parkway. The path connects to the east by crossing the collector loop. Both the east and west ends of the path should be designed as a visual focus for travelers coming into the "T" intersection in these locations.

The path should be nine to twelve feet in width to accommodate primarily pedestrians, and also bicyclists. It should be of a colored or textured paving material suitable

for intensive use and which **minimizes** glare. Along the path, lighting should be held to a minimum and yet provide sufficient illumination to ensure the safety of all users.

As illustrated in Figure 31, a meandering natural look tree groves is desired along the path corridor. Trees should provide shade and reduce glare. Lawn should occupy a significant amount of the area abutting the path. Slopes to the north between the path and residential area should be heavily planted, keeping trees and shrubs at the base of the slope. Suggested trees are discussed in Sections **4.11a** and **4.11b**.

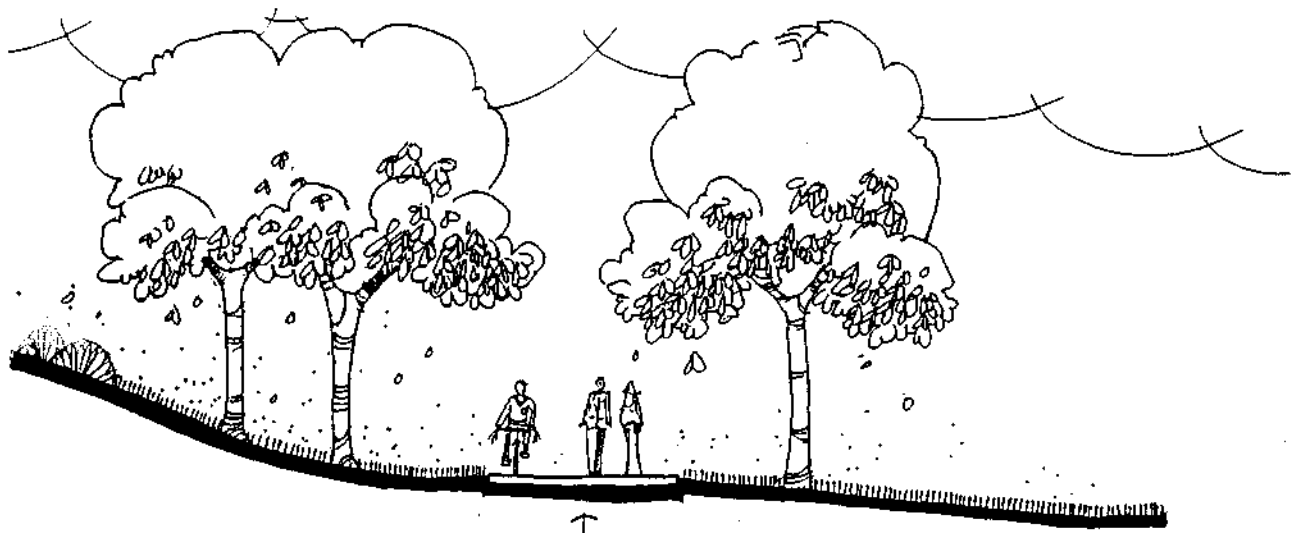

9'-12' pedestrian/bike path

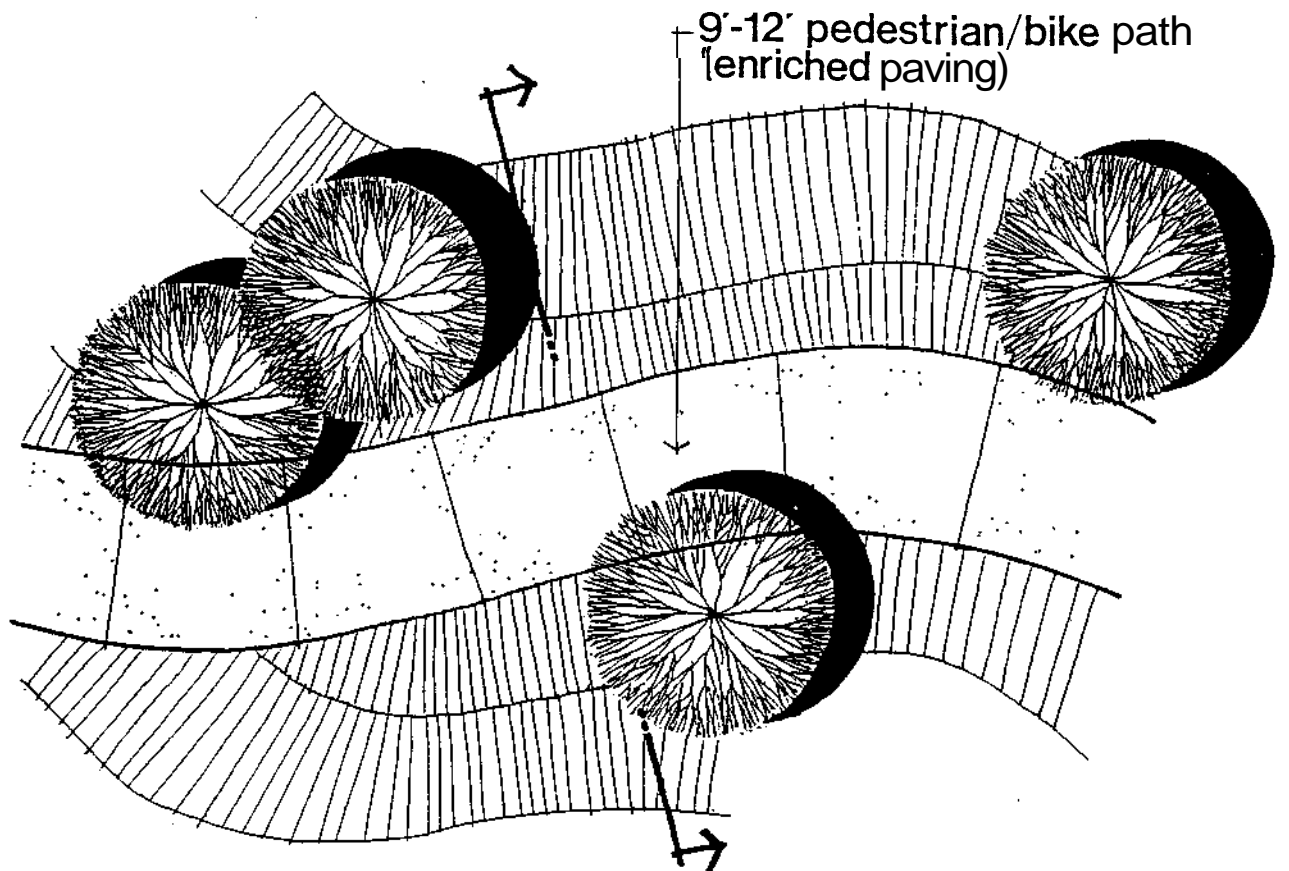

9'-12' pedestrian/bike path
(enriched paving)

BIKE/PEDESTRIAN PATH

4.12 Power Easement

The design guidelines for the power easement are based on the following objectives:

- Provide access to the power lines for pole cleaning and line maintenance.
- Screen the easement and power lines to the extent feasible.
- In **general**, discourage use of the easement for non-maintenance purposes.

A landscaping and fencing program is proposed to meet these objectives.

Vehicular access must be maintained for the entire length of the easement to permit maintenance vehicles to enter and travel along the easement. Pedestrian or bicycle travel is not encouraged along the easement. The exception is a short pathway connecting the school and park to the detached residential to the north; this pathway should receive a design treatment similar to that of the internal **bicycle/pedestrian path**, as described in Section **4.11c**.

The easement should be softened and screened by planting at the perimeter of adjacent land uses. Two fences with landscaping are **proposed**, as shown in Figure 32:

- On the eastern edge of the easement, between the detached residential area and the attached residential area located in the center of the precise plan area.
- On the western edge of the easement, between the school and attached residential area.

Treatment of the **easement** between the school and park will depend on specific school district and City design criteria. The remaining portions of the easement within the developed area should be masked by landscaping as much as **possible**, while allowing for vehicle access. A meandering natural look is encouraged with an emphasis on plants with a variety of height, form, and texture. Suggested trees are **cited** in the Recommended Tree List (Table **4**).

Within the natural open space area on the north, the easement should blend into the native scenery to the extent

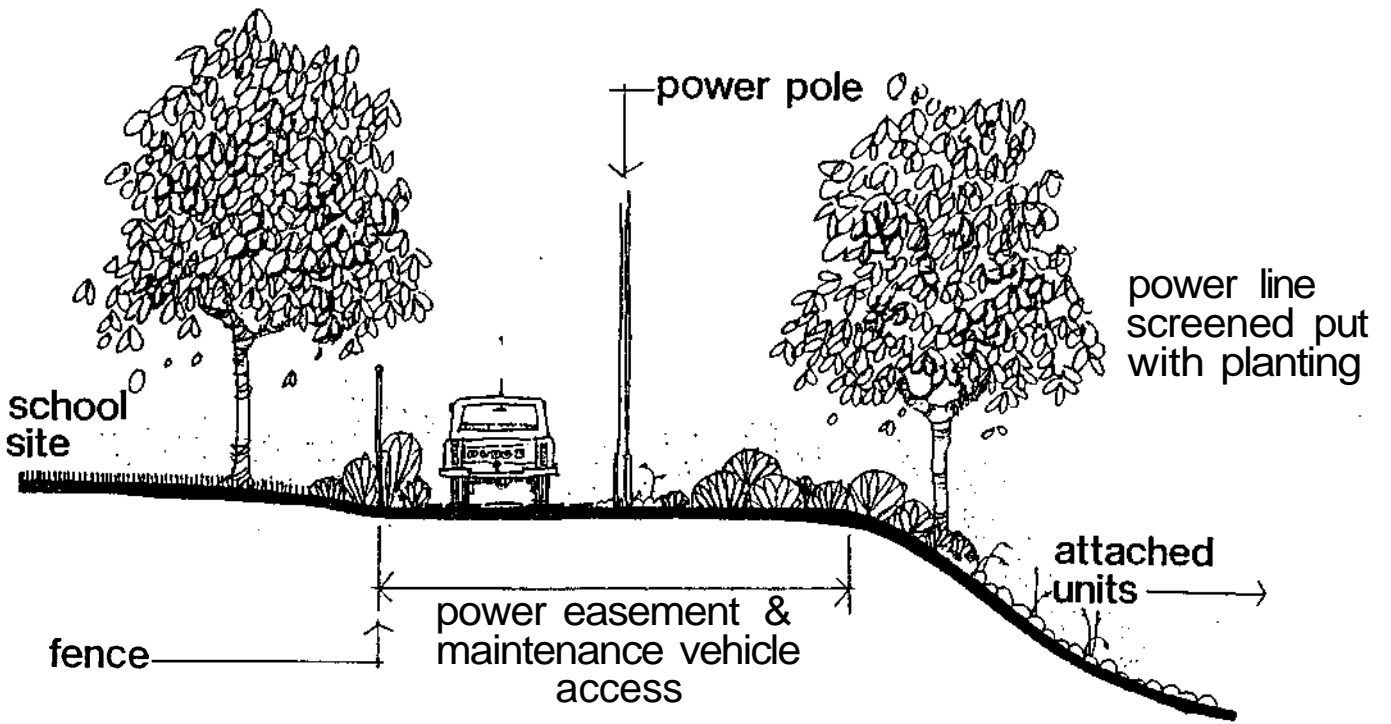
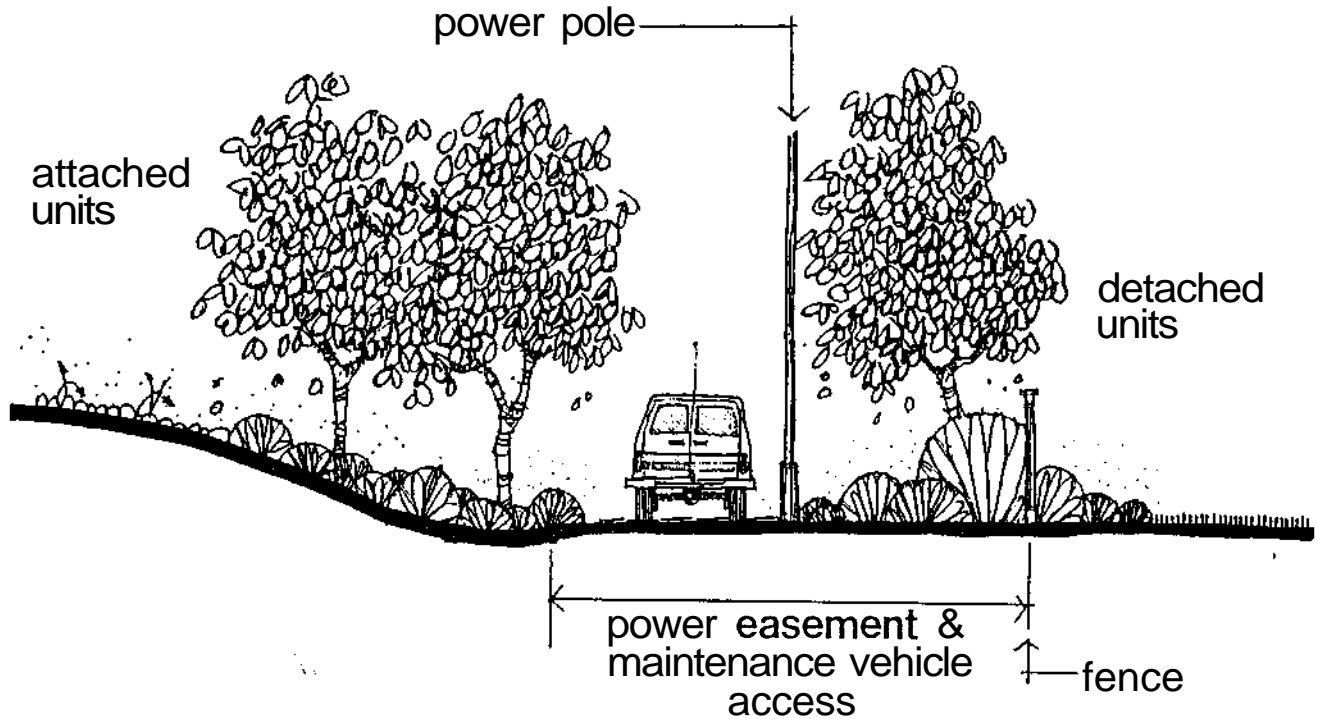

feasible. No landscaping program **is suggested** adjacent to the power poles to avoid emphasizing the easement. The possibility of massed tree plantings at the northern crossing of the collector loop should be considered for visual effect.

Chapter 5 IMPLEMENTATION ELEMENT

The purpose of this element is to provide guidelines for the timely implementation of the Unit Three precise plan proposals. Recommended zoning and other physical development controls required for implementation are summarized. In addition, a phasing program for private development and public facilities is outlined. Finally, financing of public facilities by private developers and property owners is addressed.

The **Carmel Valley** Community Plan provides guidelines for the zoning, phasing, and facilities financing within the community, which are reflected in the Unit Three proposals below. The implementation measures outlined in this chapter are incorporated where necessary into the Planned District **Ordinance**.

5.1 Physical Development Controls

As discussed in Section 1.3, the Unit Three Precise Plan **constitutes** one step in a series of steps in securing City **approval** of private development within the precise plan area. The precise plan provides guidelines for land uses and design treatments to be utilized in the review of subarea development plans and **subdivisions**. Implementation of these guidelines for the most part depends on the implementation mechanisms provided in the Planned District Ordinance.

The Planned District Ordinance should reflect the following proposals for physical development controls:

- Zoning as described in Table 5 and shown in Figure 33 to identify permitted uses in designated areas plus development regulations.
- Design guidelines as outlined in Chapter 4, Design Element.
- Grading regulations, drainage **requirements**, landscaping standards, and energy conservation criteria as described in Sections 4.3, 4.4, 4.5, and 4.6, respectively, of the Design Element.

All **subdivisions**, rezonings, and other discretionary acts required for the physical implementation of the precise plan are subject to environmental review under the provisions of the California Environmental Quality Act (**CEQA**) and the City Code. Projects should be reviewed for compliance with the mitigation measures presented in the Unit Three Precise Plan Environmental Impact Report accompanying this document.

In addition, the following conditions should be met during the development approval process:

- Prior to the approval of a tentative map, compliance with the terms of the adopted Carmel Valley Schools Facilities Master Plan must be **demonstrated**.
- A comprehensive landscaping plan must accompany each development plan and provide for the stabilization of all graded slopes.
- Approval of the first tentative map in the neighborhood should be subject to the approval of a comprehensive drainage plan for the entire precise plan **area**.

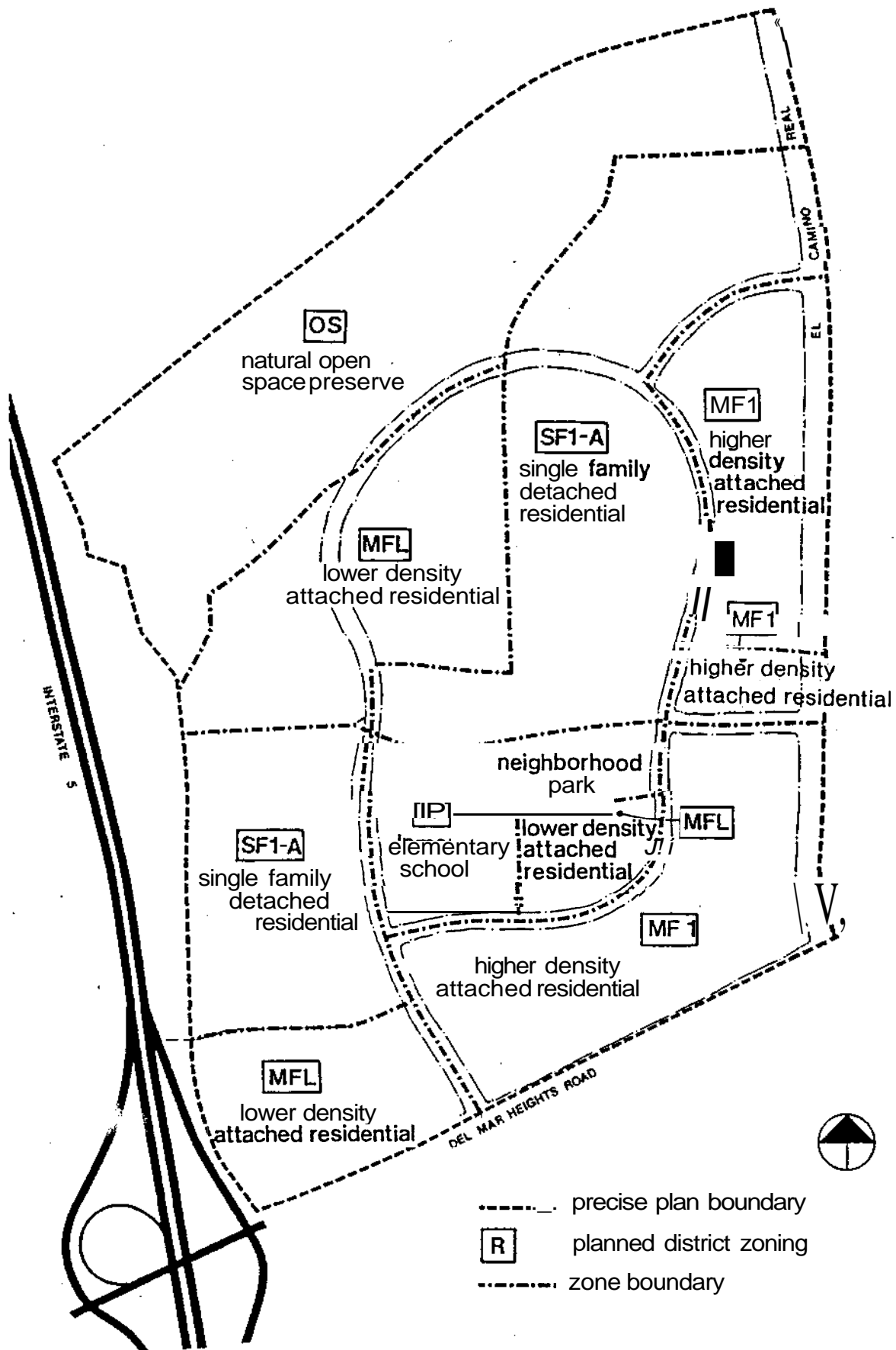

PROPOSED ZONING

Table 5

PHYSICAL DEVELOPMENT CONTROLS

Land Use Category	Planned District Zoning	Brief Description of Zone
Single-Family Detached Residential	SF1-A	Minimum lot size of 5,500 square feet
Lower Density Attached Residential	MFL	Maximum density of up to 10 dwelling units per acre
Higher Density Attached Residential	MF1	Maximum density through 14 dwelling units per acre
Elementary School and Neighborhood Park	EP	Elementary school and/or neighborhood park
Natural Open Space Preserve	OS	Open space only

The freeway buffer proposed in Section **4.7c** involves grading and landscaping within the Interstate 5 freeway right-of-way. The developer must obtain a permit from Caltrans for this work. An approved plan for the improvements and an agreement on the maintenance of landscaping are required to obtain the permit.

5.2 Development Phasing

Carmel Valley is designated a new community in the planned urbanizing area by the 1979 City of San Diego Progress Guide and General Plan. Under this designation and City Policy 600-28, a development phasing program must be adopted as part of the "precise plan planned district ordinance" for Unit Three. The purpose of the phasing program is to coordinate the timing and level of public facilities and the sequence and amount of residential development.

Figure 34 depicts the proposed phasing plan for Unit Three. This plan is based on the generalized phasing plan in the Carmel Valley Community Plan.

5.2a Residential Phasing

Table 6 shows the projected schedule of residential development by the number and type of units per phase, through total build-out. The phasing program for residential development considers the following factors:

- Phasing of grading and balancing of cut and fill.
- Provision of at least two means of access to and from the precise plan area and access from the collector street system to individual residential projects.
- A balance of single-family and attached residential and the availability of units in a range of prices.
- Marketing visibility and access.
- Availability of sewer service.
- Allowance of **adequate** time to mitigate the archaeological sites in the northwest portion of the plan area.

Each phase *is* described below:

- Phase 1

A mix of single-family and attached units is planned in the southwestern corner of the plan area. The Del Mar Heights Road neighborhood entrance provides primary access. A second access way is provided by extending the collector loop to existing Black

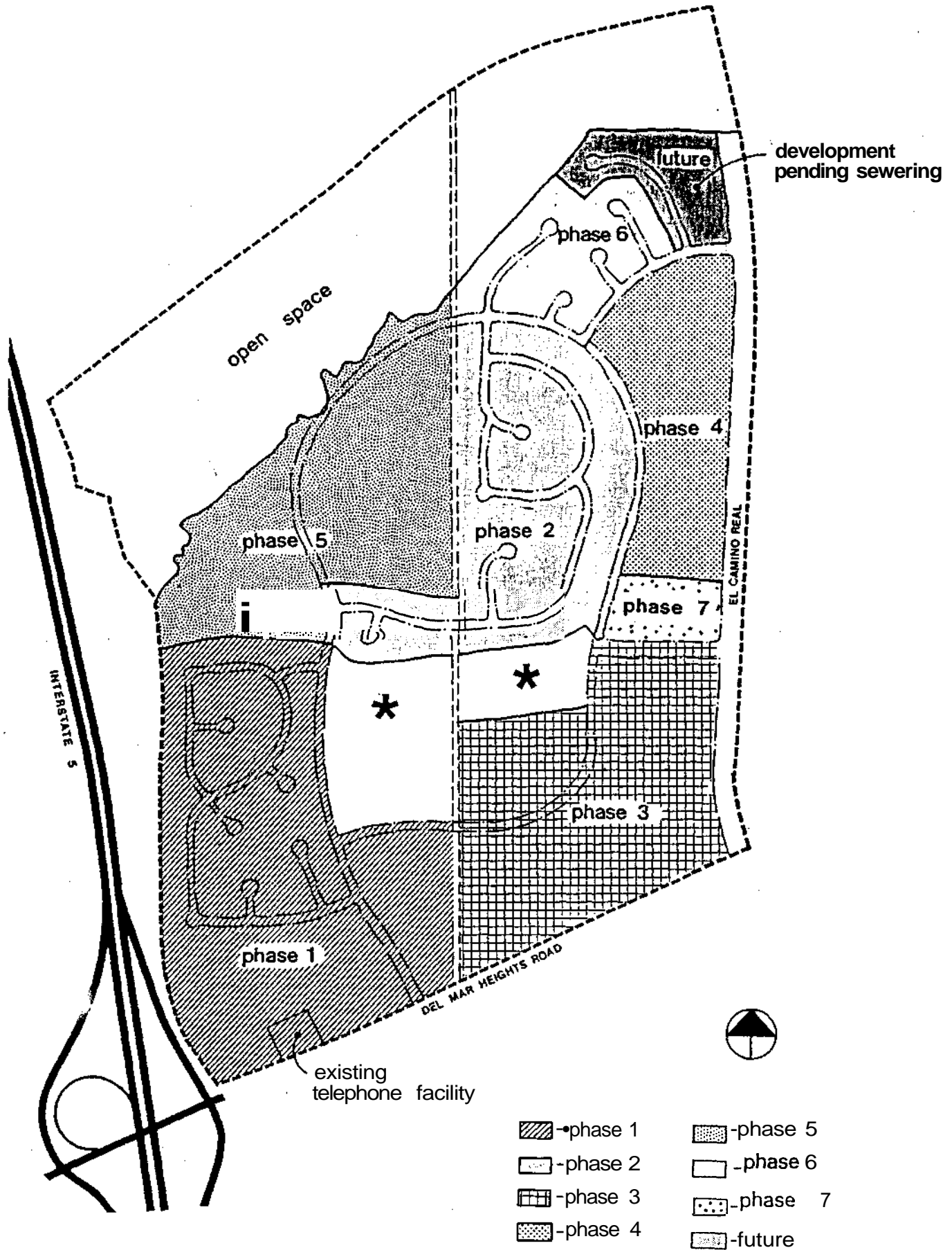

PHASING PLAN

Mountain Road, which will carry traffic eastward to El **Camino** Real. Black Mountain Road west of the collector loop will be **unnecessary**, and can be vacated. The cut from the Phase 1 area will be utilized to fill portions of El Camino Real and the Phase 3 and 4 areas. Construction of El Camino Real in its new alignment will commence during this phase. The freeway buffer will also be planted.

- Phase 2

This phase develops the single-family detached units in the north-central portion of the neighborhood. Access will be provided by extending the collector street northward from Phase 1. In addition, the El Camino **Real/north** entrance and a portion of the collector loop will be constructed to provide access to the north. El Camino Real will be improved from Del Mar Heights Road to the northern entrance and connected into the existing roadway to the north.

- Phase 3

During this phase, development of the attached residential areas in the southeast corner of the neighborhood will occur. The collector loop will be extended through the southeast **quadrant** to the El Camino Real entrance connector, which will also be completed. The Black Mountain Road link to El Camino Real will no longer be required, and can be **vacated**.

- Phase 4

Attached residential is developed on the east-central side of the plan area. The collector loop connecting the two El Camino Real entrances is **completed**.

- Phase 5

This phase develops the attached residential in the northwestern portion of the neighborhood. The **collector** loop is completed by construction of the northwest part between Phase 2 on the south and on the north. The public view overlook will be developed during this phase.

- Phase 6

During this phase, the northeastern single-family residential is developed, with the exception of the theater lots designated "future" (see **below**).

Table 6

PROJECTED RESIDENTIAL DEVELOPMENT PHASING¹

Construction Phase	Dwelling Units Completed <u>During Year</u>			Cumulative Dwelling Units		
	Detached	Attached	Total	Detached	Attached	Total
Phase 1	106	169	275	106	169	275
Phase 2	128	—	128	234	169	403
Phase 3	--	287	287	234	456	690
Phase 4	--	242	242	234	698	932
Phase 5	--	173	173	234	871	1,105
Phase 6	41	—	41	275	871	1,146
Phase 7	--	39	39	275	910	1,185
Future	14	—	14	289	910	1,199

¹Counts are approximate and subject to modification during precise design and engineering.

- Phase 7

This phase consists of a higher density attached residential area west of El **Camino** Real.

- Future

Development of the most northeasterly tier of single-family residential theater lots must be deferred until sewer service is available. A sewer pump station is required for this area.

5.2b Provision of Facilities

Public facilities will be provided as needed under the public facilities financing program outlined in Section 5.3. Provision of facilities will be as follows:

- Streets, utilities, and drainage facilities will be constructed along with residential **development**, ensuring sufficient capacity to meet residents' **requirements**.
- Construction of the school and park will occur when adequate demand warrants. Access to the school will be available in Phase 1 and to the park in Phase 3.
- Community-level facilities will be built when the service area is sufficient, with fees or assessments collected as residential construction progresses. This includes such facilities as a community park, **library**, and fire station.
- Improvements to the community-wide street system will be constructed in accordance with the Transportation Phasing Plan for **Carmel** Valley, adopted by the City of San Diego.

5.3 Public Facilities Financing

The Carmel **Valley** Community Plan requires that unit precise plans address the financing of public facilities to ensure their availability concurrent with need. In addition, the City Council has stated the following:

Development in the Carmel Valley area is contingent upon necessary public facilities being financed by property owners in that area by a charge against the land only in the planning area.

This **requirement** for a **financing** plan adopted as part of a precise plan/planned district ordinance is reiterated in Council Policy 600-28.

The financing program for Unit Three is summarized below and is subject to refinement and adoption during City review of the development plans and **subdivisions**. The program will conform to the Planned District Ordinance.

- Facilities benefit assessment against dwelling units or the equivalent within the precise plan area for public facilities and services, such as a library, a fire station, police protection, public transit, and traffic signals. In lieu credits for construction of facilities are optional.
- Standard subdivision agreements to finance on- and off-site improvements under the conventional subdivision process.
- Reimbursement agreements between developers and the City for the construction of improvements of community-wide benefit or neighborhood-wide benefit. Examples of improvements include major and arterial streets, water transmission pipelines, and sewer trunk **lines**.
- School financing as available.

Use of an assessment district created under the Improvement Acts of 1913/1915 is optional. This district could be applied to the precise plan area and utilized to finance such facilities as major utilities and perimeter arterial streets.

A community open space maintenance district should be created, which includes the precise plan area. This district should maintain and/or operate the following:

- . Selected open space areas, such as the natural open space preserve.
- . The street medians of arterial and major streets.
- . Special drainage devices and basins.

The neighborhood park should be maintained through the City operating budget.

Chapter 6 COMMUNITY PLAN CONFORMANCE

The Unit Three precise plan is based on the goals and proposals set out in the **Carmel Valley Community Plan**. Throughout this precise plan document, references are made to the community plan - how the precise plan **conforms**, where **minor** modifications are introduced, and what the precise plan specifies in greater detail than the community plan. This chapter addresses the **conformance** of the Unit Three precise plan to the community plan on a general or conceptual basis, rather than detail by detail.

6.1 Carmel Valley Goals

The Carmel Valley Community Plan sets forth five broad goals to guide urbanization in the Carmel Valley community. These goals are stated below, along with a brief discussion of compliance by this precise plan.

1. "To establish a physical, social, and economically balanced **community.**"

Development Unit Three will contain housing in the very low and low density ranges as specified in the community plan. A number of housing product types are anticipated, yielding a choice of residential lifestyles and prices. The neighborhood facilities will attract and serve a diverse population and provide equally for all residents. An internal transportation system linked to the community-wide network will ensure mobility and access to all parts of the neighborhood and the community.

2. "To establish self-containment and **feeling** of community identity among the future residents of Carmel **Valley.**"

Development Unit Three constitutes one complete, identifiable neighborhood unit of Carmel Valley while contributing to the identity and sense of **self-containment** of the overall community. The precise plan establishes a sense of neighborhood identity both functionally and aesthetically. The perimeter arterials, freeway, and open space preserve create a distinct development area which sits above adjacent neighborhood units. Access to the unit by vehicular traffic is restricted to three entrances, while the collector system provides internal access to the various residential projects and neighborhood facilities. The neighborhood facilities act as a visual focus as well as activity node for the neighborhood. Despite its strong neighborhood **identity**, Unit Three will tie to other community elements through circulation linkages, streetscape design, and visual and functional connections with community facilities, especially the town center.

3. "To preserve the natural **environment.**"

Residential and facilities development in Unit Three is concentrated in the developable portions of the

precise plan area. The northern natural open space area **preserves existing** sandstone bluffs, native vegetation, and steep topography. In regard to design treatment, the collector street parkway is designed as an integral part of the neighborhood landscape, and the overlook area blends into the natural open space to be preserved. The grading concept maximizes view opportunities while preserving the overall landform and contours artificial slopes to create a natural appearance at community **interfaces**.

4. "To establish a balanced transportation system which is used as a tool for shaping the urban environment."

Unit Three establishes an internal, neighborhood-oriented circulation system with restricted gateways linked to the community-wide circulation network. Auto, bicycle, and pedestrian path **systems** not only provide access from residential areas to neighborhood facilities but also extend to activity nodes, such as the town center, employment **center**, and future transit terminal. The internal collector street system is designed to provide a visually enhanced street scene which is punctuated by neighborhood open spaces, view outlooks, and a nonstandardized parkway treatment.

5. "To establish realistic phasing of development within the community based on maximum utilization of the privately financed public **facilities**."

Approval of the precise plan for Unit Three in itself represents a step in development phasing. The precise plan provides for the installation of public facilities by property owners as required for residential development. Financing of an **adequate** circulation system and necessary public facilities is described in the precise plan, and a phasing program for the Unit Three neighborhood is outlined.

6.2 Precise Development Plan Criteria

The **Carmel Valley Community** Plan provides guidelines for the contents and preparation of precise plans for development units. These guidelines are restated below, each followed by a brief discussion of compliance by this precise plan for Unit Three.

1. "The development unit precise plan must be in general **conformance** with the Carmel **Valley** Community Plan objectives and proposals in terms of overall density, neighborhood concept, major open space delineation and major and collector street patterns."

Table 7 summarizes the comparisons between the community plan and the Unit Three precise plan. As shown, the precise plan is in substantial conformance with the objectives and proposals of the Carmel Valley **Community** Plan.

2. The precise plan must "illustrate the complete circulation system, including local streets and transit, and further indicate how the system will relate to the total Carmel Valley circulation system."

Chapter 3 describes the complete circulation network, including the street system and transit. The ties to the total Carmel Valley system are discussed in Section 3.4.

3. The precise plan must "illustrate a system of separate bicycle and pedestrian pathways linking the neighborhood center with the residential areas and open space system and also illustrate how these pathways can link to the town **center**."

Chapter 3 outlines the bicycle system and pedestrian path network linking the neighborhood facilities and residential areas within the precise plan area. The connections to the community-wide bike and pedestrian path systems are also described.

4. The precise plan must "contain data describing the housing balance projected regarding the quantity and/or proportion of low and moderate income housing, as well as a plan describing efforts to be made to maintain an ethnic and racial **balance**."

Section 2.2 of the Land Use Element addresses residential location and mix, as well as efforts in Unit Three to contribute to housing balance community-wide.

Table 7

**CARMEL VALLEY COMMUNITY PLAN/
UNIT THREE PRECISE PLAN COMPARISONS**

Area of Concern	Unit Three Precise Plan Area	Comparable Development Unit within Carmel Valley Community Plan
Overall Density	4.13 dwelling units per acre ¹	3.81 dwelling units per acre ¹
Neighborhood Concept	Concept in conformance as described in Section 2.1a. Refined by topography , engineering studies, preservation of Torrey Pines.	
Major Open Space Delineation	Open space in conformance, preserving northern bluffs area and buffer along Interstate 5.	
Major and Collector Street Pattern	Pattern in conformance as described in Chapter 3. Alignments refined by topography, design and engineering studies.	

¹Represents total dwelling units divided by total development unit acreage. Includes 1.5 acres designated for development at 20 units per acre which are shown on the community plan within Development Unit Four (**i.e.**, the area incorporated into Unit Three as a result of the proposed realignment of El Camino Real).

5. The precise plan must **"contain a detailed design plan for the layout of the neighborhood school and park; the city and local school district must agree to the sites and design of the facility."**

In Section 2.3 of the Land Use Element, the location and characteristics of neighborhood facilities are discussed. These facilities include the elementary school and the neighborhood park. Design guidelines for these facilities are set out in Section 4.11 of the Design Element. Prior to adoption of this precise plan, the sites and designs for the school and park will be approved by the Solana Beach Elementary School District and City Park and Recreation **staff.**

6. The precise plan must "illustrate the timing of necessary public facilities through the assessment district and fees approach to serve the development."

Chapter 5 outlines the phasing and financing of public facilities.

7. The precise plan must "contain an environmental impact **statement.**"

The environmental impact report for Unit Three accompanies this document.

"A reduction of the Precise Plan Map approved by City Council. The original scale map may be inspected in the City Planning Department."



LAND USE SUMMARY

USE	ACRES	DWELLING UNITS
DETACHED HOUSING	75.6	269
ATTACHED HOUSING	101.3	910
TOTAL RESIDENTIAL	176.8	1199
ELEMENTARY SCHOOL	10.3	
NEIGHBORHOOD PARK	5.0	
EXISTING UTILITIES	2.8	
DEVELOPED OPEN SPACE	7.0	
NATURAL OPEN SPACE	62.9	
PRIMARY ARTERIALS & COLLECTORS	25.9	
TOTAL AREA	290.3	

LEGEND

- UNIT 3 BOUNDARY
- - - EXISTING CONTOURS
- PROPOSED CONTOURS
- MAJOR SLOPES
- DEVELOPMENT LIMITS
- UTILITY EASEMENTS
- BICYCLE LANE
- PEDESTRIAN 10m
- BICYCLE/PEDESTRIAN PATH

Approved by City -

PRECISE PLAN
CARMEL VALLEY DEVELOPMENT UNIT 3

