

UPTOWN COMMUNITY PLAN **URBAN DESIGN**



I. INTRODUCTION

II. GOALS & CONCEPTS

III. COMMUNITY-WIDE
DESIGN GUIDELINES

IV. AREA-SPECIFIC
DESIGN GUIDELINES

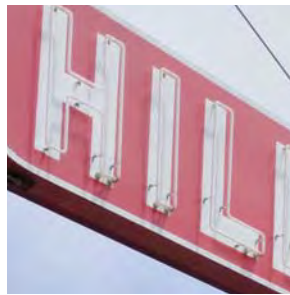

I. INTRODUCTION

II. GOALS & CONCEPTS

III. COMMUNITY-WIDE
DESIGN GUIDELINES

IV. AREA-SPECIFIC
DESIGN GUIDELINES

INTRODUCTION

What is Urban Design and Why is it Important?

Urban design refers to the physical form, character and function of our towns and cities. Its goal is not just to create well-designed buildings and public spaces, but to produce more attractive and livable places for people. In other words, urban design is about “place-making”—making places that are attractive, safe, comfortable, and have their own distinct identities.

Purpose and Use of the Urban Design Element

The objective of the Urban Design Element is to direct future development in a manner that ensures that the physical attributes that make Uptown unique will be retained and enhanced by design that responds to the Uptown’s particular context—it’s physical setting, market strengths, cultural and social amenities, and historical assets while acknowledging the potential for positive growth and change.

The Uptown Urban Design Guidelines promote design excellence in all facets of the built environment, including buildings, landscape, open space, and infrastructure. They are intended to inform property owners, developers, designers, and decision makers about the elements of good design and the importance of creating environments for people.

Relationship to General Plan

The City of San Diego General Plan, updated in 2008, provides overarching principles to guide the form and development of the City of San Diego to achieve the compact and environmentally sensitive pattern of development envisioned by the City of Villages strategy. The Urban Design Element (Chapter 5 – Urban Design) of the General Plan also includes more detailed urban design goals and policies relating to the design of the built environment. Each community planning area in San Diego is required to have a Community Plan that refines and translates General Plan policies into recommendations that are tailored to the specific conditions in each planning area. The Uptown Community Plan is an extension of the General Plan, and as such its goals, policies and recommendations must be consistent with broader General Plan policies. This Uptown Community Plan Urban Design Element is intended to implement the General Plan’s urban design goals and policies, which are discussed in greater detail in Section II: Goals and Concepts.



The Hillcrest sign at the core of the Hillcrest Business District is a known icon of Uptown.

Relationship to Other Plans and Ordinances

In addition to the General Plan, a number of other City plans and ordinances apply to the Uptown Community planning area:

City of San Diego Street Design Manual

All street design guidelines and urban design recommendations that relate to improvements within a public right-of-way will consider and be adherent to the street design standards set forth in the San Diego Street Design Manual. Guidelines will also consider level of service standards and carrying capacity of thoroughfares that will determine design interventions.

City of San Diego Municipal Code

The Municipal Code contains the development regulations and permitted land uses for all land uses in Uptown. The Municipal Code also contains any zoning or implementation overlay (CPIOZ) districts that occur within Uptown. The regulations in the Municipal Code will continue to prevail and be used in tandem with the Uptown Community Plan urban design guidelines.

Mid-City Planned Development Ordinance

The Mid-City PDO was created to address the special development conditions of the mature neighborhoods contained within Uptown and Greater North Park with specialized development objectives and allowed land uses. This allows the neighborhood to support a range of commercial district types, including “Commercial Node,” “Commercial Linear,” “Commercial Village,” and “Neighborhood Professional Commercial Office” zones. Transitional commercial zones allow for limited commercial expansion off the main corridors.

The PDO also includes several Residential (“MR”) zones, which are multi-family residential land uses intended to be compatible with the pattern of existing neighborhoods. Height limits, residential density, yard dimensions, defensible space, and architectural guidelines ensure site-specific compatibility for infill development. It is expected that the current Uptown Community Plan Update will either build upon the current Mid-City PDO or new zoning will incorporate the recommendations of the Plan.

TABLE 1: SANDAG SMART GROWTH PLACE TYPES IN UPTOWN

Place Types	Locations in Uptown	Minimum Residential Target	Minimum Employment Target	Minimum Transit Service Characteristics
Urban Center	Hillcrest Core	75 du/ acre	50 empl./acre	Light Rail/ Rapid Bus
Community Center	Mission Hills Commercial Area (Washington Street)	20 du/ acre	None	Light Rail/ Rapid Bus (via 5-minute transit/shuttle connection)
	Mission Hills/ India Street Commercial Area			
Special Use Center	UCSD Medical Complex	Optional	45 empl./acre	Light Rail/ Rapid Bus
Mixed-Use Transit Corridor	Between 1st and 6th Avenues in Bankers Hill	25 du/ acre	None	Light Rail/ Rapid Bus

West Lewis PDO (2007):

The West Lewis Street PDO, located in Mission Hills, is surrounded by the Mid-City PDO, but is tailored for the commercial uses within the surrounding single-family residential area. The area includes the pedestrian-oriented commercial area of West Lewis Street between Stephens and Lark Street. Permitted uses include neighborhood-oriented stores and services and residential uses.

SANDAG Smart Growth Guidelines

The SANDAG Smart Growth Guidelines were created in 2009 to apply a form-based approach to infill design in the County of San Diego. The approach included applying Place Types to key opportunity areas, which apply regulations of residential density, employment generation, and transit accessibility. These are a comprehensive approach to design guidelines that are meant to apply throughout the County and create consistency amongst individual areas that share distinctive attributes.

In these Guidelines, all of Uptown is designated as a "Transit Priority Area." Within this area, specific Place Types are identified. Within these geographic areas, which are shown in the below Table, guidelines for residential density, employment generation, and transit accessibility apply, in addition to the overall guidelines of site and building design, street character, transit facilities, and parking regulations.

Relationship to Other Community Plan Elements

Urban design addresses the relationship between all elements of the urban environment and how they interrelate. As such, the recommendations of the Urban Design Element are intrinsically linked to all of the elements, but particularly the land use, circulation, parks and open space, historic preservation elements. Land use influences building height and form, as well as the location and character of public spaces. Streets provide the basic framework of neighborhoods and influence both built form and walkability. Street function (e.g., the volume and speed of traffic) also plays a definitive role in the pedestrian experience and the design of the pedestrian realm. Transportation and parking recommendations also can shape a neighborhood, based on where transit links occur, where parking is located and how much is required, and if buildings are primarily accessed and experienced by pedestrians or from moving vehicles. Parks and open space are also crucial to urban design. The location of parks and open space can significantly affect community identity and social interaction, and the availability of parkland can influence intensity of development and built form.

History of Development

Uptown's physical form and design character is a product of a rich history, reflecting contributions from over a century and a half of growth and transformation that first started in the late 19th century. From the beginning, the area has been valued for its proximity to Downtown and its unobstructed views of the harbor. As a result, the Uptown community includes some of San Diego's oldest neighborhoods characterized by a wealth of historic structures, a variety of architectural styles, and mature landscapes. It also includes some of the City's most popular current neighborhoods and quality new development that reflects recent trends towards more compact development and urban lifestyles, as well as a century worth of infill, replacement and modification in between.

Although significant development in Uptown was not to occur until the late 1880's, early platting of subdivisions in response to development speculation was the first step in establishing the area's current form. The 1867 platting of Horton's Addition, which stretched from Front Street to Upas Street, and Sixth Avenue to Interstate 5, established the framework of future streets, blocks, and parcels that



Source: (needed)

still characterizes the area. Subsequent subdivision platting of Hillcrest, Mission Hills, and University Heights in the late 19th century similarly established the development pattern for these areas, even though they would not be developed until decades later.

Development in Uptown generally began in the southern portion of the Uptown during the 1880's and '90's, in what is now known as Park West. Over the next two decades, new development extended northward towards present-day Hillcrest and University Heights, due in large part to the construction of several public transit lines that connected the area to the Downtown. Development during this period was primarily residential, but by the early 1900s the area was also home to several businesses, a state Normal School and the popular Mission Cliff Gardens.

Development activity accelerated once more in anticipation of the much awaited 1915 Panama-California Exposition. In addition to private homes, numerous apartments, hotels, businesses, churches and institutions were constructed across Uptown and shaped its communities into discernible streetcar suburbs. By the 1920s, both Park West and Hillcrest were almost entirely developed, and the more distant communities of University Heights and Mission Hills were nearly built out by the 1930s.

Following the Great Depression and World War II, Uptown was the target of several redevelopment efforts and witnessed a considerable amount of physical change. Due to the scarcity of available land for development, many older buildings were replaced with larger buildings including both residential and commercial properties. In areas like University Heights increased demand for apartments resulted in a substantial number of single-family homes being removed for multi-family apartment buildings. During this period, the scarcity of developable land

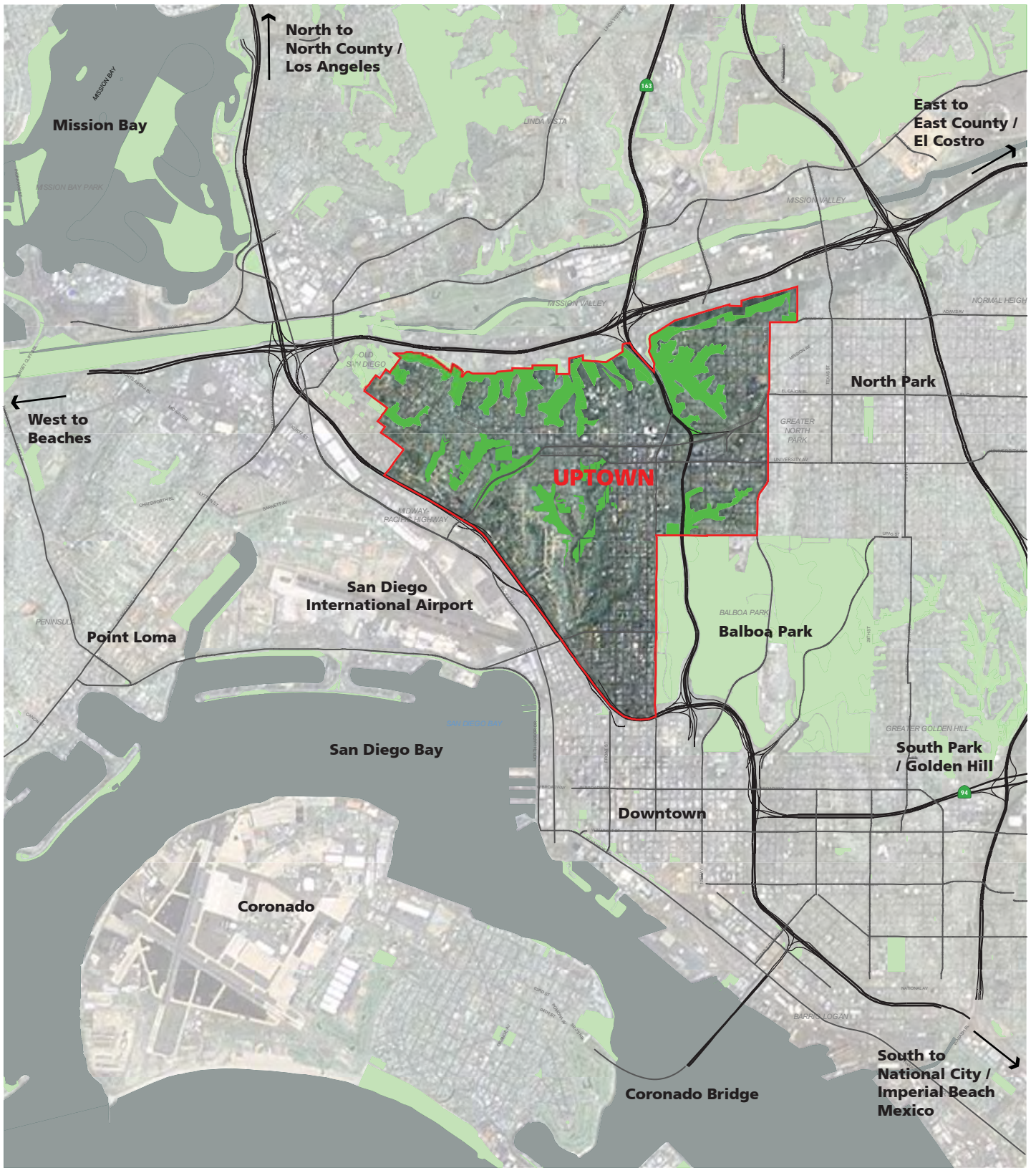

FIGURE 1: COMMUNITY PLAN CONTEXT

also resulted in development new homes along steep canyon rims and slopes previously considered unbuildable.

Development from this era reflected Post-War American values and design trends, such as automobile oriented commercial development and Modern design in both residential and commercial buildings. During this time, new commercial development began to take on new forms reflecting the orientation to the automobile. New commercial “strips” were developed along the community’s primary vehicular corridors, new shopping centers were developed, and retailers like Sears moved to Uptown. Most of this new commercial development was accompanied by on-site surface parking, a feature almost never incorporated in earlier commercial development. Streets, such as Park Boulevard and University Avenue, formerly the home to streetcar lines, were transformed into heavily traveled motorways during this period. The rise of the automobile also resulted in the construction of Interstate 5 along the Uptown’s southern and western boundaries which resulted in the razing of entire blocks in Middletown and created a barrier between Uptown and Downtown.

During the 1960’s and 70’s, suburbanization of the City’s outlying areas resulted in decay and disinvestment in the Uptown as middle class households and retail began to flee to the suburbs. The construction of suburban shopping malls, such as the Mission Valley Shopping Center in 1961, drew customers away from Uptown’s commercial nodes and threatened the area’s economic vitality. Redevelopment efforts intended to reverse such trends resulted in the loss of many older homes, which were replaced with an assortment of single family, multi-family and commercial uses. Many substantial structures, including the Florence Hotel and the Normal School, were demolished during this time to make way for new development.

Ultimately, the effects of disinvestment and suburban flight created the conditions (e.g., safe, affordable, etc.) that attracted the lesbian and gay community to settle and invest in Hillcrest in the 1980’s. The economic renaissance stimulated by the Gay community not only resulted in the rehabilitation and reuse of existing buildings, both commercial and residential, but also generated significant new commercial and residential development throughout the 1990’s and early 2000’s.

Key characteristics of much of this development include higher densities, mixed use development, and greater pedestrian orientation. In the commercial realm, the development of the Uptown Shopping District on the former Sears site, and the development of Village Hillcrest on 5th Avenue are excellent examples of development that embody these characteristics and begin to reverse the development trends of the 60’s and 70’s that were so deleterious to the community. As are residential projects like the Egyptian and Decca on Park Boulevard, that introduce higher density development while preserving and referencing historic architecture that is important to the community’s identity.

All in all, the Uptown’s urban design character is a unique “temporal collage” of development and physical improvements from all of San Diego’s eras, from 1887 mansions, to 1920s bungalows, to 1970s 8-plex apartment buildings (“Huffmans”), to 21st century mixed use projects.

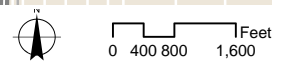
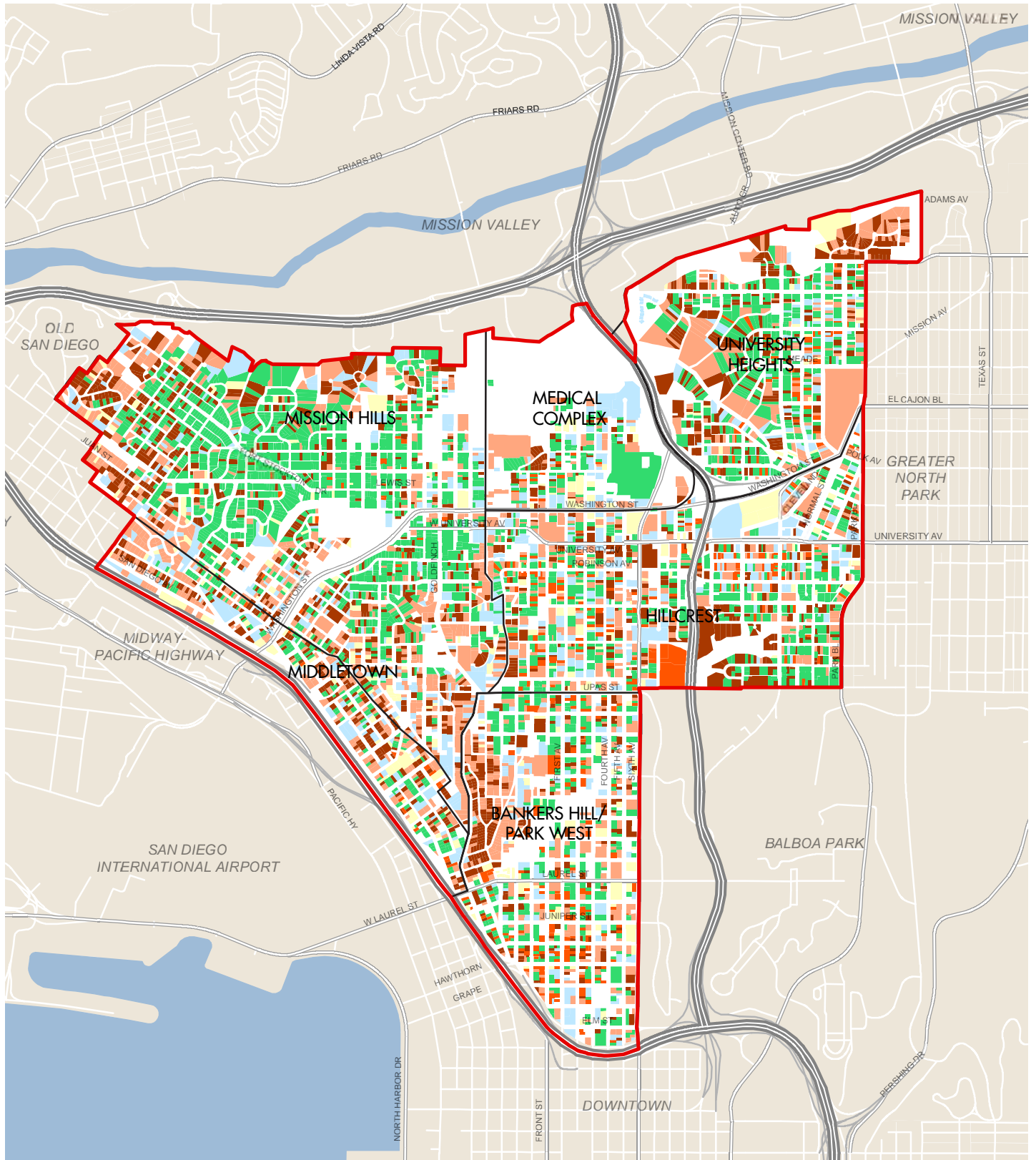
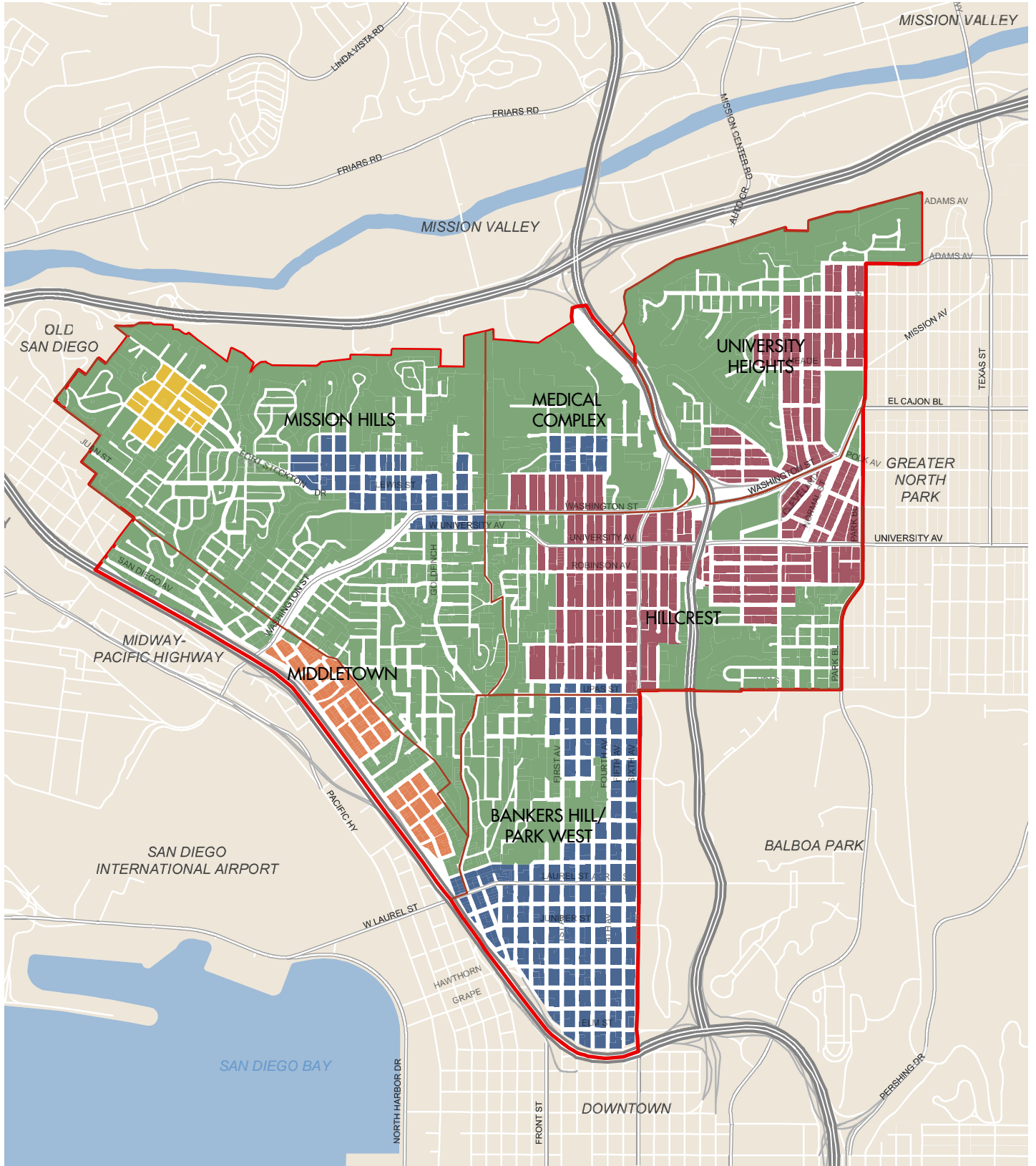

FIGURE 2: BUILDING AGES



LEGEND

- ◆ Square blocks
- ◆ Short blocks
- ◆ Irregular Blocks
- ◆ Hillside Grid Blocks
- ◆ Long blocks with Alleys
- Community Plan Boundary
- Neighborhood Boundary

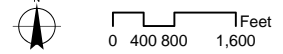

FIGURE 3: BLOCK TYPES

Urban Form Analysis

Community form and character are influenced by elements at all scales, from the street sign to the planning area. Identifying these key elements is the first step in understanding how to protect and enhance community character. At the macro scale, there are a number of elements that play a critical role in the Uptown's identity.

Topography

The Uptown's location on a level mesa that is divided by steep, heavily-vegetated canyons is a primary, character-defining feature. The mesa's elevation gives the area a sense of seclusion from Centre City, Mission Valley and other surrounding communities, and provides a sense of openness with scenic views of downtown, the harbor, Coronado, Point Loma, and Mission Valley. The canyons, which run north to Mission Valley and southwest to the Harbor, provide fingers of open space that extend deep into the heart of the area, introducing a natural element into the built environment and creating natural boundaries between neighborhoods

Parks and Open Space

Parks and open space play a significant role in contributing a sense of openness and greenery to the Uptown that provides an appealing contrast to the generally urban context. As discussed above, the canyons represent a major open space resource that flows throughout the community. These natural elements are augmented by two major parks located adjacent to the Uptown—Balboa Park to the southeast and Presidio Park to the northwest. While not in the Uptown, both contribute to a verdant, open character. The influence of Balboa Park on community character is most evident in development along 6th Avenue where the amenity value of the park has contributed to a distinctive pattern of mid- and high-rise buildings.

Circulation

Streets are a critical element in defining urban form, providing the basic physical framework for development that influences the size and scale of buildings, community connectivity, and basic walkability. The network of streets in Uptown influences community character in both obvious and subtle ways. The size and configuration of blocks has influenced both the



Parks and Open Space

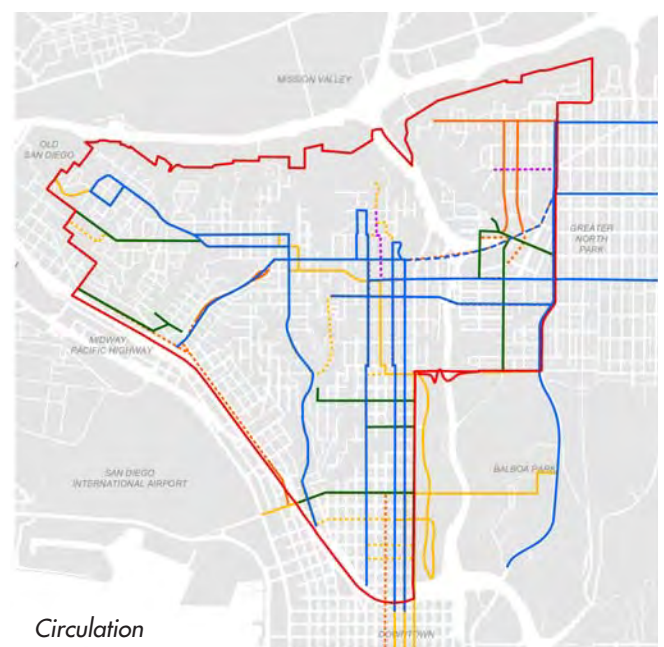

Circulation

COMMUNITY CHARACTER

character and function of neighborhood development. The small, squarish blocks in Park West and Mission Hills contribute a more intimate and walkable scale to their neighborhoods. The longer rectangular blocks in Hillcrest and University Heights are generally less pedestrian-scaled, but the presence of mid-block alleys has a positive influence on street character by reducing the number of curb cuts and driveways.

The width of streets and the volume of traffic they carry also has significantly influenced community character. The 68' curb-to-curb width of North Street in University Heights has a distinctly different feel from the 30' width of Jackdaw Street in Mission Hills. Similarly, the traffic volumes on 2nd Avenue create a much different character than that on 5th Avenue even though both have the same dimensions. The issue of traffic volumes is directly tied to the constrained street connectivity within the Uptown. Due to the prevalence of canyons, only a few street corridors provide continuous connections through the area. As a result, the character of streets like Washington Avenue, 5th Avenue, University Avenue, Park Boulevard, and Laurel Street is affected by high traffic volumes and travel speeds.

Land Use

Uptown is made up of a diverse mix of land uses. Land use is an important element that influences urban design in that each land use generates distinct building types and circulation patterns, which inform the urban experience. Residential is the predominant land use in the Uptown, but there are also several nodes of retail, employment, and mixed use—which includes retail, residential, and office uses. These generally are located along the major transportation corridors, where convenient accessibility better supports commercial uses.

The largest retail concentration is in the Hillcrest core where several of these major corridors intersect. Retail also extends in a more linear orientation along Washington Street west of the core, and University

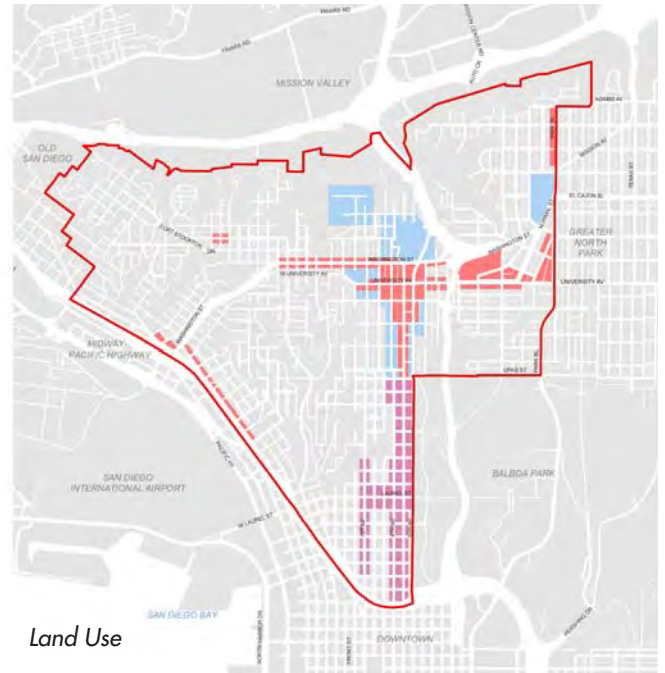

Land Use

Avenue east of the core. Smaller neighborhood-scale retail nodes also exist in Uptown's residential neighborhoods, such as on Park Boulevard in University Heights and on West Lewis Street in Mission Hills. Within these mixed use areas, pedestrian-oriented streets and building frontages create a vibrant public realm. The concentration of hospitals and medical support uses in the Medical Complex neighborhood have their own distinct physical form, and the distribution of office uses along 4th and 5th avenues contributes a distinct personality to these north-south corridors.

Landmarks and Nodes

Throughout the Uptown there are several distinctive nodes and landmarks that contribute to community character and enhance the area's identity. Generally these are associated with key land use areas and neighborhood centers, but occasionally they are more solitary elements of unusual distinction. The Hillcrest core, University Heights shopping district, the India Street commercial area, and UCSD/Scripps Mercy medical center are all examples of key nodes or destinations within the Uptown. Buildings such as St. Paul's Cathedral, Village Hillcrest, and the Teachers Training annex serve as identifiable landmarks. As do the Uptown's unique

A Community of Distinct Neighborhoods

Uptown is known for its distinct neighborhoods and the strong sense of place associated with each. The evolution of the Uptown through numerous eras, and the topographic definition created by the canyons, has resulted in neighborhoods that have developed unique architectural, landscape, and demographic characteristics. The distinctiveness of the individual neighborhoods is highly valued by the Uptown community, and a key objective of the urban design guidelines is to protect and enhance the qualities that make these neighborhoods unique.

Given the damage to neighborhood character that has accompanied some past development, the community is interested in exploring the use of Conservation Areas (see inset) as a mechanism to protect neighborhood character in those areas that have a strong positive identity and design character. Several potential Conservation Areas have been identified in the Uptown, but additional analysis and community input is required before they can be adopted. In the interim, guidelines for a pilot Conservation Area are included in Section IV: Area-Specific Design Guidelines to illustrate the type of controls that might be applied in future Conservation Areas.

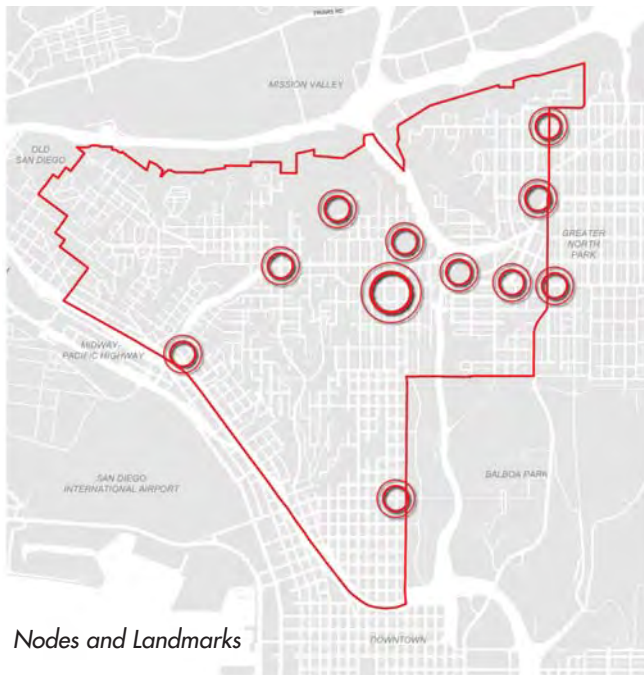

Nodes and Landmarks

pedestrian bridges (Quince, Spruce, and Vermont Street bridges) and gateway signs (Hillcrest, Mission Hills, and University Heights). Landmarks and nodes are important components of urban design because they contribute to how the community is perceived. They serve as memorable elements within the urban fabric that create positive associations and allow people to create mental maps that facilitate

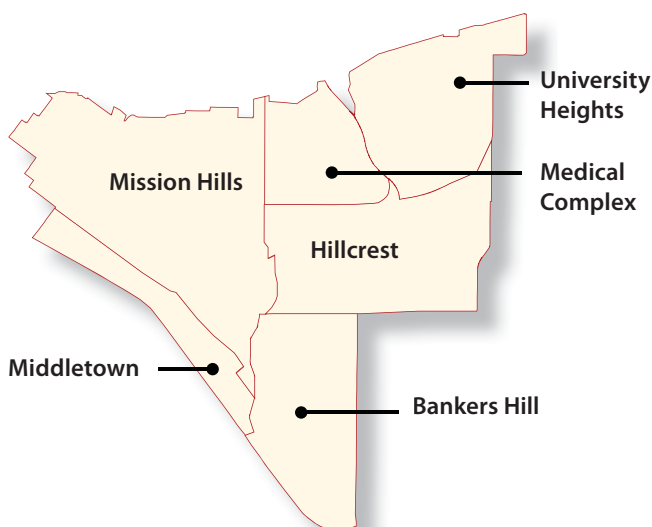

The Neighborhoods of Uptown

CONSERVATION AREAS

A conservation area is a tool to protect neighborhood character rather than historic integrity, which is the function of historic districts. While historic districts are created with the intention of preserving a specific time period of architectural character, and are overseen by local, state, and federal historic preservation standards and law, Conservation Areas are less defined and are more driven by community input. They can be any size and based on any defining-element such as scale, setbacks, street or landscape character, or building typology. The strategy for Conservation Areas is described in **Section IV: Area-Specific Design Guidelines**.

COMMUNITY CHARACTER

Mission Hills

Location and Character:

Mission Hills includes the area of Uptown generally south of Mission Valley, west of Curlew Street and Reynard Way, north of Norton Avenue, and east of the Old San Diego community plan area.



Topographically the neighborhood consists of the relatively flat upper elevations of the mesa and a series of steep canyons that extend out from the neighborhood to the north and south. On the north, the topography falls off sharply providing sweeping views of Mission Valley from the canyon rims. The more gradual slopes to the south and west provide dramatic views out toward the Bay and Downtown. The deep, heavily vegetated canyons divide the neighborhood into a series of secluded sub-neighborhoods buffered by open space.

Mission Hills is a primarily residential community consisting of predominantly single-family homes. Commercial and mixed use development is generally located along Washington Street, with a small neighborhood-serving commercial area at West Lewis and Stephens streets. A series of higher density, multi-family developments are located north of Washington between Eagle and Ibis streets.

Streets and Blocks:

The street pattern reflects Mission Hills' topography, with small square and rectangular blocks occupying the flatter areas at the top of the Mesa, and curvilinear, non-continuous streets, and irregular blocks responding to the topography of the canyons. The street system provides a hierarchy of streets and street widths, with the majority of streets being quiet, relatively narrow

residential streets. Fort Stockton Drive and Sunset Boulevard serve as residential collectors that distribute local traffic in the upper areas, and Reynard Way distributes traffic to the south.

Washington Street, which bisects Mission Hills, is the primary corridor providing access into and through the neighborhood. It is a busy, 4-lane arterial whose scale and character sharply contrasts with the placid character of the rest of the neighborhood. The high volumes of traffic along Washington have generated a predominance of auto-oriented commercial uses and design responses in the section east of Washington Place. Addressing the scale, character and safety of the commercial portion of Washington Street is an urban design priority. West of Washington Place the street drops into a canyon and creates a physical divide in the community.

Building Heights and Development Intensity:

Existing building heights are predominantly one to two stories (24'-30') with a cluster of three- to five-story (30'-60') buildings north of Washington between Eagle and Ibis streets, and a lone 13-story residential high-rise at Ibis and Fort Stockton. Development intensity in Mission Hills is generally among the lowest in the Uptown, ranging between 1 and 14 units per acre. Higher densities are primarily concentrated along the east end of Washington Street and Fort Stockton Drive.

Architecture and Landscape:

Architecturally, Mission Hills is the most historically and architecturally intact of all of Uptown's neighborhoods, representative of San Diego's early development periods and including fine examples of the City's most elegant homes. Although there are homes from the late 19th Century to the late 20th Century, the majority of structures were built between 1900 and 1949 in conjunction with early subdivisions. The range of architectural styles reflects the design trends

I. INTRODUCTION

COMMUNITY CHARACTER



Mission Hills is known for its historic homes, dramatic canyons and views, and charming neighborhood amenities.

of the periods in which they were constructed. By far, however, the most prevalent styles are Craftsmen, Spanish Colonial, Mission Revival, Colonial Revival, and Prairie. Mission Hills also contains several examples of Art Deco, Modern/International Style, and Contemporary residences. The commercial architecture in the neighborhood generally lacks the quality of the residential development, but there are some recently-completed examples of infill development that is more complementary to the surrounding context. The maintenance of Mission Hills' historic integrity,

neighborhood scale, and character is a top priority of the community.

In addition to the neighborhood's dramatic canyons and views, other landscape features that contribute to the area's identity include the generally mature vegetation that characterizes the neighborhood, the use of Queen palms as street trees, and the prevalence of low front yard walls—many using local cobblestone

COMMUNITY CHARACTER

Hillcrest

Location and Character:

Hillcrest is generally bounded by Washington Street on the north, Dove and Curlew Street on the west, Upas Street on the south, and Park Boulevard on the east. Topographically, the developed portion of Hillcrest is relatively flat. While canyons extend into the southern portion of the area, and the SR-163 canyon bisects the neighborhood, the influence of canyons and views on the area's character is less prominent than it is in the other Uptown neighborhoods.

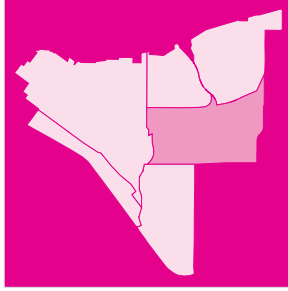

From a land use perspective, Hillcrest is the most diverse of the Uptown neighborhoods, containing more retail, office and mixed use development and more varied residential opportunities. The area contains the primary commercial core of Uptown, which is concentrated around the intersection of Fifth Avenue and University Avenue, and extends several blocks east, west, south. This area is a vibrant pedestrian-oriented commercial center, as well as the center of community activity for Uptown with active, walkable streets, mixed-use buildings and retail, office, and entertainment activities. Commercial development also extends along University Avenue east of SR-163. This retail is more linear in nature and feels more automobile oriented due to the width of University and the high volumes of traffic. However, streetscape improvements and the development of the mixed use Uptown District have contributed to a more pedestrian-friendly environment. In addition to single family residential development along the fringes of the area, Hillcrest includes a variety of multi-family residential developments in both stand-alone and mixed use formats.

Streets and Blocks:

Hillcrest is generally characterized by a grid of streets that, unlike Mission Hills, includes very little variation in response to topography. The predominant block pattern consists of long rectangular blocks (300' x 600') with a mid-block alley running the length of the block. While retaining the same general dimensions, the blocks are oriented north-south along the Avenues, but are rotated east-west along University Avenue and Robinson Avenue, and then northeast/southwest along Normal Street.

Streets and traffic play a significant role in defining the character of Hillcrest. From a physical standpoint, SR-163 bifurcates the neighborhood creating situation in which Robinson, University and Washington are the only connections between the two halves. From a functional standpoint, Hillcrest serves as the crossroads for Uptown with the major north-south and east-west through streets intersecting in the Hillcrest core. This means the area must contend with high traffic volumes, particularly on Washington, University, and 4th and 5th avenues, while trying to preserve the core area's pedestrian orientation. Normal Street represents a unique feature in the street system with its diagonal orientation, its extremely wide right-of-way, and relatively low traffic volumes.

Building Heights and Development Intensity:

Hillcrest is one of the more intensely developed neighborhoods in Uptown. Although there are areas of single family development, residential densities in much of the area range from 30 to 100 units per acre. Similarly, commercial development intensities are the highest in Uptown, particularly in the core retail district where no development setbacks are required and surface parking is at a minimum.

Hillcrest includes a range of building heights. The majority of the structures are one- and two-stories tall, but more recent mixed use and residential

I. INTRODUCTION

COMMUNITY CHARACTER



Hillcrest is among the most vibrant and eclectic neighborhoods in Uptown, with historic neighborhoods anchored by established commercial corridors.

development generally tends to be in the 3- to 7-story range. The area also includes a handful of residential high-rise buildings, all of which were developed to take advantage of views of either Balboa Park or the Bay. Taller buildings are scattered but tend to be located in the core along 5th Avenue, near Park Boulevard and University Avenue, or at the north end of Balboa Park.

Architecture and Landscape:

Buildings in Hillcrest include a range of architectural styles that reflects both its buildout over many eras, but also the fact that commercial properties have experienced more redevelopment over the years. As a result no style or period of architecture predominates. Residential clusters along 1st and 2nd avenues and east of S163 and south of Robinson, still include numerous examples of styles associated with early San Diego development, such as Craftsman, Bungalow, Prairie, and

COMMUNITY CHARACTER

Mission and Spanish Revival. Commercial architecture is a combination of historic commercial buildings, such as on the corner of Fifth and University, and more auto-oriented buildings from later generations. Infill development completed in the last several years has introduced new architectural forms and styles, many that try to complement the form, scale and stylistic precedents in the Hillcrest community.

Medical Complex

Location and Character:

The Medical Complex area is bounded by Interstate 8 on the north, Washington Street on the south, State Highway 163 on the east and the Dove Street Canyon on the west. Topographically the area consists of relatively flat mesa top that extends north from Washington Street until it is deeply cut along the north edge by two canyons that flow down to Mission Valley. The rim of the canyon provides dramatic views north over Mission Valley.

The area is dominated by the presence of two medical centers: Scripps Mercy Hospital and Medical Center and the UCSD Medical Center. Together the two centers and other medical support uses occupy over 40% of the neighborhood. The majority of the remaining portion of the Medical Complex area is occupied primarily by residential uses, with the preponderance of it being multi-family housing developments, much of which serves as housing for medical center employees. The north side of Washington Street, west of 4th Avenue, is developed with free-standing, auto-oriented retail and commercial uses.



Streets and Blocks:

Immediately north of Washington Street, the block pattern is the same as in Hillcrest, with long north-south blocks with mid-block alleys. As the streets extend north to the canyons, the block dimensions begin to shift, first losing the mid-block alley, and then the blocks morph into large-scale development parcels and the rectilinear streets transform into curvilinear cul-de-sacs that respond to the topography at the canyon interface. The scale of the streets in the Medical Complex is similar to the residential portions of Mission Hills, with narrow, intimate streets. With the exception of Bachman Place which extends north through the area to Mission Valley, the streets in the Medical Complex only provide for internal circulation with the only external connections being to Washington Street.

Building Heights and Development Intensity:

Washington Street forms the boundary between Hillcrest and Medical Complex, and marks the transition from Hillcrest's pedestrian-oriented retail district to the more automobile-oriented medical center uses. Buildings are noticeably taller in the Medical Complex than they are in the Hillcrest core just to the south. The two medical centers, which are both 8-12 stories tall, are surrounded by development that is predominantly 3 and 5 stories, particularly in the area east of 1st Avenue. The western portion of Medical Complex has more single family housing that is 1 to 2 stories tall. Development intensities, both residential and institutional, are also generally higher than in the majority of the Uptown. Residential densities of 30-100 du/acre are common, and the hospitals and medical office buildings have quite high floor area ratios.

Architecture and Landscape:

Of the neighborhoods in Uptown, Medical Complex contains the lowest proportion of single-family homes. Stylistically, single-family residential buildings are similar to those in other parts of Uptown, including

I. INTRODUCTION

COMMUNITY CHARACTER



Medical Complex is dominated by the medical center and medical-related uses, surrounded by primarily multi-family housing developments and single-family homes.

examples of early California styles. The medical, commercial, and multi-family buildings are more contemporary, reflecting a combination of mid-century and late Modern and Post-Modern styles. The medical buildings also have a much more institutional character that distinguishes them from other development in the Uptown, and there is a much higher occurrence of free-standing parking garages, many of which have been sited in canyons to reduce the apparent mass. The character of the pedestrian realm varies according to

the prevalent use. The more residential areas generally have pleasant streetscapes, frequently with street trees, while less attention is paid to the pedestrian environment around the hospitals, where the primary mode of access is vehicular.

COMMUNITY CHARACTER

Bankers Hill/ Park West

Location and Character:

Bankers Hill/ Park West is located south of Upas Street, east of Reynard Way, west of Balboa Park and north of Interstate 5. Its proximity to Downtown and Balboa Park has been an important influence on the development of Uptown. Similarly, the topography, which slopes down to the south and west, plays an important role in the character of the area, providing dramatic views of both the Downtown and the Bay, and influencing the design of buildings. The canyons that cross the northwest corner of neighborhood introduce a natural open space element to the neighborhood and form a distinctive contrast to the regularity of the grid of streets that characterizes the majority of the area.

Land uses in Bankers Hill/ Park West include single-family neighborhoods isolated by canyons in the northwest portion of the neighborhood, older multifamily residential development in the southwest area, and a significant component of professional office uses that extend the length of the area along the avenues. Small clusters of neighborhood commercial are located on Reynard Way between Eagle Street and Falcon Street, on First Avenue between Ivy Street and Juniper Street and at the intersection of Fifth Avenue and Laurel Street. These commercial centers function as central nodes of neighborhood activity and provide a variety of neighborhood services including grocery stores, dry cleaning businesses and entertainment establishments.



Streets and Blocks:

As one of the first parts of Uptown to be developed, Park West is characterized by the historic grid street pattern that is an extension of the pattern in the Downtown. The grid is comprised of short blocks (200' x 300'), that do not contain alleys. Blocks near canyons are irregular and break away from the grid to respond to the topography. A key characteristic of streets in Park West is that they are generally wider than all but major collector streets in the rest of Uptown. With curb-to-curb cross-sections of 50 feet, these streets can accommodate three travel lanes and two parallel parking lanes, which is typical along the avenues. In some places, where traffic volumes are not high, these widths have been reconfigured to provide two travel lanes with diagonal parking on one side.

The linear north-south streets in Bankers Hill/ Park West serve as major connectors between Downtown and Balboa Park and the Uptown neighborhoods. The direct connection provided by the avenues to the Downtown results in particularly high traffic volumes, particularly along 4th and 5th. The width of 4th and 5th avenues and their designation as one-way streets also contributes to higher travel speeds along these routes. First and Fourth Avenues cross historic bridges that are iconic and represent the special relationships with canyons in the neighborhood. Laurel Street, which originates along the Bay, is a primary connector within Banker's Hill, connecting the Bay to Balboa Park and Uptown neighborhoods.

Architecture and Landscape:

Bankers Hill /Park West contains some of the oldest architecture in Uptown, including several large Victorian and Queen Anne homes dating back to the 1870s. Otherwise, Banker's Hill expresses a range of architectural styles and building ages—including

I. INTRODUCTION

COMMUNITY CHARACTER



Bankers Hill/ Park West contains a varied mix of building ages and architectural styles oriented along the Avenues and integrated within canyons.

several recent, high-density mixed-use developments along the “Avenues,” to single- and multi-family neighborhoods characterized by Craftsman bungalows, Mission Revival, and Colonial Revival. Several churches and office buildings also represent distinctive architectural styles and periods of the development of the neighborhood.

Heights and Development Intensity:

Heights in Bankers Hill are highly varied. Several buildings of 13 stories and above are located between Fourth, Fifth and Sixth Avenues, while the majority of buildings are low-rise (below 4 stories). Banker’s Hill has more generous height limits than elsewhere in Uptown, including a height limit of 150’ along Fifth and Sixth Avenue. These allow greater building heights and views along Balboa Park. Residential density is greatest

COMMUNITY CHARACTER

closest to Downtown with several buildings of over 100 du/acre located along Grape and Hawthorn Streets and Interstate 5. In the northwest corner of Bankers Hill, near the canyons, residential density is lower (1-15 du/acre), as buildings step down to integrate with the neighborhood.

Middletown

Location and Character:

Middletown is bounded by Horton Avenue and Titus Street to the east, Laurel Street, and Reynard Way to the south, Interstate 5 to the west and Witherby Street to the north. Historically the area included areas to the west and south of Interstate 5, but since the construction of the freeway are now outside of the Uptown Community Plan boundary. Topographically, Middletown is built on a west-facing hillside facing the Bay. Buildings step up the slope creating a distinctive urban character and providing numerous scenic views to San Diego Bay.

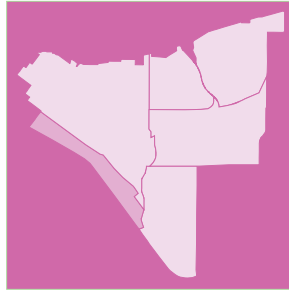

Streets and Blocks:

The Middletown street system is generally laid out in a grid pattern, running parallel to Interstate 5. The hillside grid blocks which are located south of Washington Street are generally more regular in shape and are distinctive in that they are oriented to respond to the downward-sloping hillside rather than maintain the north-south orientation of Downtown or Bankers Hill/ Park West blocks. North of Washington Street, the blocks are more irregular in response to both canyon topography and large footprint uses such as hotels and large commercial/ light industrial buildings. The majority of the streets are relatively narrow residential streets that carry local traffic. San Diego Avenue/India

Street, which parallels the freeway, is a busy collector street that carries both local traffic and serves as a frontage access road for I-5.

Architecture and Landscape:

The architecture of Middletown is diverse - representing periods of San Diego's earliest growth to contemporary styles, including both single- and multi-family residences to large scale light industrial buildings, and commercial uses. Among the residential areas, Middletown has the highest concentration of Contemporary, Ranch, and Minimal Traditional buildings, as well as other vernacular styles. Representing a later period of development and modern infill, building ages range from 1930-1948 to 1949-1970.

Heights and Development Intensity:

The architecture of Middletown is diverse - including examples of San Diego's earliest growth through to contemporary styles, including single- and multi-family residences, large-scale light industrial buildings, and commercial uses. Among the Uptown's residential areas, Middletown has the highest concentration of Contemporary, Ranch, and Minimal Traditional buildings, as well as other vernacular styles. These styles are consistent with Middletown's later period of development, between 1930-1970, coupled with more recent infill development. While most of the area does not have formal or consistent street tree planting, Middletown has a relatively lush landscape character which is due in part to the sloping topography, which tends to make landscaping on private lots more visible.

I. INTRODUCTION

COMMUNITY CHARACTER



Middletown consists of single- and multi-family homes in a variety of styles situated along a sloping street grid and the Washington and India Street commercial nodes.

COMMUNITY CHARACTER

University Heights

Location and Character:

The University Heights area is part of two community planning areas: North Park and Uptown. The portion of the University Heights neighborhood in the Uptown plan area is north of Washington Street, east of State Route 163, south of the Mission Valley community plan area and west of Park Boulevard. Topographically, University Heights occupies the relatively flat top of a mesa that is ringed on three sides by canyons. The extensive perimeter of canyon interface and the views it provides creates a sense that the neighborhood is a peninsula of development. Views of Mission Valley and Mission Bay are prominent from the rim of the canyon.



University Heights is a predominantly residential neighborhood, with multi-family residential predominant along the major north-south streets west of Park Boulevard and single-family residential around the canyon perimeter. A well-established, and popular, commercial district occupies the north end of Park Boulevard and is the center of the greater University Heights community. The San Diego Unified School District and Birney Elementary School occupy a major site at the southeast corner of the neighborhood where Park Boulevard, Washington Street and El Cajon Boulevard come together.

Streets and Blocks:

The predominant block pattern in University Heights is the same long, north-south blocks with mid-block alleys that exist in Hillcrest. The block pattern becomes irregular as it approaches the canyon rim, and then transitions to a series of spoke-like cul-de-sacs, like Proctor Place, Rhode Island Street, and New Hampshire

Street, that extend out between the canyons. As in Park West, University Heights has very broad streets (50 foot). Since these streets generally accommodate only local traffic, they are relatively quiet streets with an open and airy character.

Building Heights and Development Intensity:

University Heights is a low-rise neighborhood. Residential development is 1- to 2-stories, or 24 to 30 feet in height. Commercial development along Park Boulevard is also predominantly 1- to 2-stories, but there are scattered instances of buildings that are 3 stories tall. Despite its relatively low profile, University Heights is one of Uptown's denser neighborhoods due to the high number of multi-family units. Densities range from 15 to 100 units per acre in the blocks east of Maryland Street, while single-family neighborhoods between Maryland and the 163 are between 1 to 14 du/acre.

Architecture and Landscape:

University Heights is one of the earliest neighborhoods in San Diego. The northerly terminus of Park Boulevard once served as the terminus of the San Diego Cable Railway (1890-1892) and later trolley. The area west of Park Boulevard includes examples of the architectural styles associated with the eras in which University Heights first developed, including Craftsman, Arts & Crafts, Bungalow, Prairie, Mission and Spanish revival, and Monterey, including early commercial as well as residential buildings. Most buildings date from 1910-1929 and 1930-1948 with infill from later periods. Office and public institutional uses are clustered at the intersection of Park Boulevard, El Cajon Boulevard, and Normal Street, which include the San Diego City Schools Education Center and Alice Birney Elementary School. These occupy large parcels and signify an institutional presence and a gateway into the neighborhood.

I. INTRODUCTION COMMUNITY CHARACTER



University Heights consists of primarily single-family homes oriented around canyons and broad residential streets with Park Boulevard as the primary commercial district.

The landscape character of the neighborhood is strongly associated with the natural landscape at the canyon perimeter. The Park Boulevard commercial district has a particularly attractive planting of palms and liquidambers to give the street an intimate and distinctive character. Within the residential areas, streetscape planting is relatively sparse, although some streets have effectively used palm trees to unify street character. The Vermont Street pedestrian bridge, connecting University Heights to Hillcrest, the

University Heights gateway sign, and the Mission Cliff cobblestone wall on Adam Street are all distinctive features that contribute to neighborhood character.

This page to be left blank.



I. INTRODUCTION

II. GOALS & CONCEPTS

III. COMMUNITY-WIDE DESIGN GUIDELINES

IV. AREA-SPECIFIC DESIGN GUIDELINES

GENERAL PLAN STRATEGIES & GOALS

General Plan Strategies & Goals

The intent of the Uptown Community Plan is to apply and advance the vision and concepts established in the City of San Diego General Plan in a manner that is specific to the Uptown. The General Plan sets forth a series of principles that provide a comprehensive approach to Urban Design that applies to all areas of the City. These principles provide the framework for developing more specific guidelines that applicable to Uptown's unique neighborhoods. The following are the Urban Design Vision and Goals set forth in the General Plan.

URBAN DESIGN STRATEGIES

The City of Villages Strategy described in the General Plan Urban Design element sets forth the following urban design goals and strategies that have informed the Uptown guidelines:

- Contribute to the qualities that distinguish San Diego as a unique living environment;
- Build upon our existing communities,
- Direct growth into commercial areas where a high level of activity already exists;
- Preserve stable residential neighborhoods.

GENERAL PLAN URBAN DESIGN GOALS

- A built environment that respects San Diego's natural environment and climate.
- An improved quality of life through safe and secure neighborhoods and public places.
- A pattern and scale of development that provide visual diversity, choice of lifestyle, opportunities for social interaction, and that respects desirable community character and context.
- A City with distinctive districts, communities, neighborhoods, and village centers where people gather and interact.
- Maintenance of historic resources that serve as landmarks and contribute to the City's identity.
- Utilization of landscape as an important aesthetic and unifying element throughout the City.

SUMMARY OF COMMUNITY PROCESS

Input from the Uptown community has been essential to the Community Plan update. An advisory committee—the Uptown Community Plan Update Advisory Committee (CPUAC)—was formed to gather public input and advise City staff and decision-makers during the planning process. Regular meetings were conducted between 2009 and 2011 to receive updates on the planning process, review and provide feedback on planning topics, receive public input on community issues and visions, and recommend new policies and guidelines for the updated community plan. In addition to the CPUAC meetings, community-wide workshops and charrettes were held to give the community the opportunity to provide feedback and prioritize key issues that applied both generally and to key focus areas. In addition, a series of “Open Mic” sessions were held that allowed various interest and advocacy groups to discuss their specific concerns in an open forum.

The CPUAC was comprised of a diverse representation from the community, including members of the Uptown Community Advisory Board as well as at large members. In addition to CPUAC and the general community, several advisory and interest groups from Uptown neighborhoods provided formal input into the process. These groups include, but are not limited to: the Hillcrest History Guild, the Hillcrest Business Association, University Heights Planning Committee, University Heights Community Development Corporation, and Mission Hills Heritage. The input from these groups has been considered and incorporated into the Guiding Themes and Concepts for Uptown as well as individual guidelines.

Guiding Themes & Concepts for Uptown

A key outcome of the community planning process was the identification of a series of recurring themes and concerns expressed by the Uptown community. These themes and concerns have been summarized into a series of principles that have guided the formulation of the Community Plan’s Urban Design recommendations.

“Walkable Washington”

“Building Articulation”



Members of the Uptown community provide input for potential Conservation Areas at October 2010 Charrette.

“Eyes on the Street”

HOLD FOR SORTED COMMENTS FROM CITY

GUIDING THEMES & CONCEPTS

Maintaining Distinctive Neighborhoods



COMMUNITY CONCERN: *Losing the qualities and resources that make the Uptown unique to new development.*

The Uptown is blessed with a variety of distinct character areas that contribute to the planning area’s unique identity. Uptown’s network of traditional residential neighborhoods, dynamic retail centers, quality mixed use development, thriving employment centers, and verdant canyons and parks make it one of San Diego’s most desirable places to live, work, and recreate. As a result, the area has experienced significant pressure for growth and change. A goal of the Community Plan is to maintain and enhance the distinctiveness that makes the Uptown special, while still accommodating healthy growth and change.

Encouraging Development Diversity



COMMUNITY CONCERN: *Maintaining the demographic, architectural, and economic diversity that have contributed to the Uptown’s vitality and aesthetic vibrancy.*

Uptown is characterized by diversity in both the built environment and its population that has resulted from a development history that has created a rich inventory of architectural styles and a social history that has seen the area’s renaissance from the effects of suburban flight. This diversity is highly valued by the community. It is important that as the neighborhood experiences change, that new development continues to provide a rich mix of land uses, architectural styles, and development intensities that will support diversity in housing and employment opportunity, building types, and civic experience.

Preserving Historic Resources



COMMUNITY CONCERN: *Preserving the Uptown’s historic fabric by preserving important resources, adaptively reusing older buildings, and sensitively responding to the scale and character of historic buildings.*

Uptown contains a rich representation the architectural styles associated with San Diego’s early periods of development and growth. This includes architectural styles popular in the late 19th and early 20th centuries (e.g., Spanish and Mission Revival, Victorian, Queen Anne, Craftsman, Arts & Crafts Bungalows, etc.), as well those from later in the 20th Century (e.g., Art Deco, Modern, International, etc.). However, too many fine examples of early architecture have been lost to past redevelopment, and the community is concerned that the richness of the community’s cultural history and physical environment not be depleted by future development. Ensuring that future development both preserves important historic resources and sensitively

GUIDING THEMES & CONCEPTS

responds to context are important objectives of community design guidelines and development regulations.

Creating a Complete, Well-Served Community



COMMUNITY CONCERN: *Ensuring that new development neither diminishes existing levels of service nor exacerbates existing deficiencies.*

Neighborhoods such as Uptown are defined by a dynamic mix of uses, businesses, and services that are closely and conveniently accessible through multiple modes of transportation. While the Uptown is already one of the City’s most successful examples of a complete mixed-use community, it is important not only that new development not diminish the mix of uses or the provision of services. It will be important that new development be seen as an opportunity and a mechanism to remedy existing deficiencies, whether it be for community centers, neighborhood parks, or streetscape maintenance. Urban Design recommendations include considerations for the maintenance and accessibility of services and an attractive urban environment.

Ensuring Vibrant Commercial Districts



COMMUNITY CONCERN: *Creating a physical environment that supports retail and entertainment activities that are intrinsic to Uptown.*

Uptown is home to a number of vibrant commercial districts. The largest and most visible is the Hillcrest Core, but each of Uptown’s neighborhoods includes a commercial node that is important to neighborhood character and vitality—5th Avenue and Laurel in Park West, Washington and Goldfinch in Mission Hills, India Street and Washington in Middletown, and Park Boulevard in University Heights. The success of these areas derives from a number of factors, including having an active pedestrian environment, buildings that engage the street with sidewalk cafes and shop windows, and nearby residents who frequent them. Urban design recommendations, linked with land use and mobility recommendations, are intended to maintain and enhance the social and economic vibrancy of these areas by improving the quality of the public realm and ensuring that buildings are designed to actively engage the public realm.

GUIDING THEMES & CONCEPTS

Providing Convenient Parks and Distinctive Open Space



COMMUNITY CONCERN: *Desire for more and better distribution of parks, including small pocket parks and spaces for community gardens, and better trail connections to canyons and other open space.*

Parks, open spaces, and canyons are a key feature of Uptown, as well as much of San Diego. Balboa Park and Presidio Park, which are adjacent but not part of Uptown, are important resources that serve the community. Unfortunately, these regional park resources do not meet the community’s daily recreation needs. Similarly, the canyons, which are so prominent within the Uptown, represent an underutilized recreation resource. The urban design guidelines suggest strategies for adding parks and open space within developed areas in conjunction with new private development and improvements to the public realm. The guidelines also address strategies for enhancing connectivity to open space resources and preserving the visual quality of the canyons.

Walkable Neighborhoods and Complete Streets



COMMUNITY CONCERN: *Streets should include guidelines to accommodate bicyclists and pedestrians safely, and reduce vehicular travel speeds.*

The walkability and animated pedestrian life of Uptown is one of its most celebrated features, yet there are a number of areas of the community where walking is not a pleasant or particularly safe experience due to vehicular activity and street design. The concept of “complete” streets that are designed to safely and attractively accommodate all modes of travel—pedestrians, bicyclists, transit users, and drivers—in a balanced manner is a key urban design concept. The urban design guidelines, in conjunction with the Mobility Element, provide a series of recommendations for how to improve the pedestrian, bicycling and transit experience so that people are inclined to drive less and enjoy it more.

Maintaining Appropriate Building Scale and Density



COMMUNITY CONCERN: *Taller buildings and increased density will reduce the quality of life by increasing congestion and destroying community scale and character.*

Scale and density are a primary concern for many when considering future development in the Uptown. Development is necessary however, to maintain Uptown’s vibrancy, address people’s desires to live and work in Uptown, and address City’s responsibilities for meeting fair share of regional growth. The scale

GUIDING THEMES & CONCEPTS

of buildings and the density of development are not necessarily the same thing. Addressing where taller buildings is appropriate and where higher density development, whether tall or not, are important issues for the community. In either case, building design should respect the scale and character of the existing community, utilizing appropriate strategies to allow density to discreetly blend into the current form and scale of the adjacent buildings and the community in general. These recommendations are included as guidelines for the private realm and may be tailored from neighborhood to neighborhood. Conservation Areas are one tool available to address these items in a comprehensive manner.

Creating Graceful Transitions



COMMUNITY CONCERN: *New commercial development should not interfere with stable residential areas, and new residential development should respect the scale of established neighborhoods.*

In older, mixed-use neighborhoods like Uptown with commercial uses adjacent to residential areas, and new denser development being introduced adjacent to older low density development, creating graceful transitions between buildings is crucial to preserving community character. This involves maintaining privacy and minimizing shading and solar access issues. The design guidelines include recommendations for sensitively integrating new development into its context by utilizing setbacks and stepbacks between buildings and property lines that will minimize these conflicts.

Re-establishing Transit as a Viable Transportation Alternative



COMMUNITY CONCERN: *How to make transit a more attractive and viable alternative to the automobile in order to reduce traffic congestion in the Uptown.*

Uptown has been identified as a “Transit Priority Area” in the recently-completed SANDAG Regional Plan and Smart Growth Guidelines. This plan also recommended that several corridors in Uptown accommodate the creation of Rapid Bus systems that link the city. Currently, Uptown is connected by multiple bus routes, providing access to adjacent areas and to Downtown. With air quality standards and regional sustainability goals, transit use is encouraged to reduce daily vehicle trips. These recommendations for transit use may be linked with building guidelines that will include lower parking standards than are required in less dense areas. This will encourage transit use and contribute to regional goals and planning efforts.

Integrating Parking into the Urban Fabric



COMMUNITY CONCERN: Adequate parking should be provided throughout Uptown to support commercial activity, but older patterns of surface parking in front of businesses needs to be addressed.

Parking plays a critical role in community character and economic vitality. Businesses need parking to ensure their successful operations, particularly when convenient and attractive transit service is not available. Yet, surface parking is unattractive and adversely affects pedestrian activity and economic vitality, and structured parking is expensive and increases the size and mass of buildings. The guidelines provide recommendations for addressing parking in a manner that sensitively integrates it into the community, yet does not allow parking to determine community character.

Designing for Sustainability in Buildings and Sites



COMMUNITY CONCERN: Adequate parking should be provided throughout Uptown to support commercial activity, but older patterns of surface parking in front of businesses needs to be addressed.

Long-term sustainability has become an imperative for building and site design. New development within Uptown communities needs to be designed to reduce energy use, resource consumption, and waste. New construction will be encouraged to be LEED certified, Green Points rated, or equivalent, and must abide by California's Title 24 Standards and Building Code (CalGreen), which also include stringent sustainability goals. Similarly, retrofitting older buildings and sites will be encouraged to explore opportunities to introduce sustainable design elements. Guidelines for both the public and private realm will be based on the principles and precedents of sustainable design, including the energy and water efficiency, and the use of climate-appropriate planting materials, irrigation standards, and local and renewable building and hardscape materials.

This page to be left blank.

I. INTRODUCTION

II. GOALS & CONCEPTS

III. COMMUNITY-WIDE DESIGN GUIDELINES

Commercial & Mixed-Use Areas:

PUBLIC REALM:

- Complete Streets*
- Street Types*
- Parking*
- Pedestrian Improvements*
- Streetscape Improvements & Furnishings*
- Street Trees*
- Sustainable Infrastructure*
- Public Art*

PRIVATE REALM:

- Site Planning & Block Structure*
- Overall Building Design Guidelines*
- Design Guidelines by Building & Typical Block Type*
- Component Glossary & Diagrams*
- Parking*
- Historic Resources*
- Sustainable Design*
- Canyon Interface*

Residential Areas:

PUBLIC REALM:

- Residential Streets*
- Parking*
- Streetscape Improvements, Landscape & Furnishings*
- Sustainable Infrastructure*

PRIVATE REALM:

- Site Planning*
- Design Guidelines by Building & Typical Block Type*
- Building Scale, Massing and Configuration*
- Historic Resources*
- Sustainable Design*
- Canyon Interface*

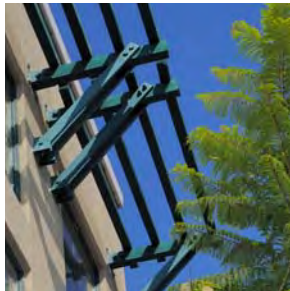
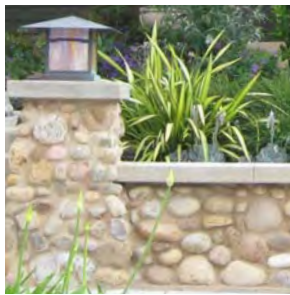

IV. AREA-SPECIFIC DESIGN GUIDELINES

COMMERCIAL & MIXED-USE AREAS

To reflect the diverse environments within Uptown, the guidelines are grouped into two categories: Commercial & Mixed-Use Areas and Residential Areas. The Residential Guidelines apply broadly to the less dense, more established neighborhoods that occupy the majority of the planning area and tend to experience less change. The Commercial & Mixed Use guidelines generally apply to the Uptown’s retail areas and employment areas, and areas that have been identified for higher density and future change.

PUBLIC REALM

From an urban design perspective, the Uptown’s development fabric is composed of two distinct, yet inter-related components: the “public” realm and the “private” realm. The “public realm” consists primarily of the publicly-owned street rights-of-way and other publicly accessible open spaces such as parks, squares, plazas, courtyards, and alleys. The “private realm” is generally the privately-owned area developed with buildings and associated improvements, and is more limited in its accessibility to the public. Although it occupies the smaller proportion of the Uptown’s area (approximately one third), the public realm plays a critical role in the area’s character and function, serving several inter-related and overlapping roles, including:

Circulation and Access. The public street rights-of-way provide for circulation within and through the Uptown—accommodating pedestrians, bicycles, and buses, in addition to automobiles and trucks.

Development Framework. The public street rights-of-way provide the fundamental structure that contains and organizes individual developments into a cohesive whole.

Public Open Space. In addition to the Uptown’s parks and plazas, public street rights-of-way play an important role as public open space—allowing for light, air, landscaping within developed areas, and serving as the “living room” for community life—places where people meet, interact, and linger.

Visual Character. While buildings are important visual elements, the physical design of the public realm is critical in establishing the Uptown’s identity and overall character.

The intent of design guidelines is to ensure that the blending of public and private realms creates a seamless and inviting environment for all. Private realm guidelines tend to focus on new development projects or enhancements to existing development, while the public realm guidelines will influence public projects, such as street and streetscape improvements, street frontage and open space improvements associated with private development proposals.



Diagram of Public vs. Private Realm

Complete Streets

Currently, existing street design in the Uptown tends to place the efficient movement of motor vehicles above all other considerations. Consistent with the Federal Complete Streets Act of 2009, the California Complete Streets Act (AB 1358), and community input, the guidelines are informed by a desire to have the Uptown’s streets provide more balanced accommodation of all modes traffic that is also safer, more attractive, and more convenient for pedestrians, bicyclists, transit users.

THE FEDERAL COMPLETE STREETS ACT OF 2009:

A roadway that accommodates all travelers, particularly public transit users, bicyclists, pedestrians, and motorists, to enable all travelers to use the roadway safely and efficiently.

AB 1358 – CALIFORNIA COMPLETE STREETS ACT:

Requires all CA cities and counties to consider complete streets when next updating their General Plan.

The guidelines are intended to reduce the conflict between people, bicycles and cars, while also acknowledging the functional requirements of public streets to provide access to and within the Uptown. The guidelines recommend options for re-designing streets to reduce the speed of moving vehicles, create buffers between pedestrians and moving vehicles, and clearly delineate zones that vehicles share with people, bikes, and transit. These options include actions such as reducing the number and/or width of lanes, widening sidewalks, adding medians, adding diagonal parking, adding bike lanes, and necking down intersections.

Street Types

Uptown contains a variety of different streets types that differ in both function and design. Some streets, such as Washington Street and Park Boulevard, function as major through vehicular travel corridors that provide primary access to and through the area. Others, such as University Avenue and Fifth Avenue, serve as major connectors to adjacent neighborhoods. The majority of the streets, however, serve primarily as local streets that provide access to residential neighborhoods and shopping districts and carry much lower volumes of traffic.

The urban design guidelines are intended to respond to and complement the functional classification and level-of-service requirements identified in the Mobility Element. Six general street types are addressed by the following discussion:

- Major Connector Streets
- The Avenues
- Pedestrian-oriented Retail Streets
- Green Streets
- Bicycle Boulevards
- Alleys

The following discussion sets forth a number of possible scenarios for altering the design of street cross-sections within the existing public right-of-way to achieve one or more of the community’s objectives for the Uptown. In some instances, the recommendation is specific to a particular street, but more often the design is descriptive of a condition. The intent is not to comprehensively re-configure the streets of the Uptown, but to suggest a series of design options that might be introduced incrementally as conditions warrant and circumstances permit.

Major Through-Corridor Streets

Major Through-Corridor Streets serve as the major circulation routes connecting the Uptown to freeways and state highways, and to the surrounding City context. They allow efficient circulation of high volumes of traffic through the Uptown. Uptown's two Through-Corridor Streets are Washington Street and Park Boulevard. Both streets are characterized by wide right-of-ways, multiple (4 – 6) travel lanes, relatively high travel speeds, and limited pedestrian and bicycle facilities or streetscape amenities. The functional and aesthetic character of these corridors is not conducive to pedestrian, bicycle or transit use. As a result, development along these corridors tends to be more automobile-oriented in scale and design.

Recommendations:

- Where feasible, measures should be implemented to reduce the actual and/or apparent width of the vehicular travelway in order to both slow traffic and facilitate safe pedestrian crossing. Such measures might include:
 - The reduction of lane widths
 - The removal of travel lanes
 - The incorporation of a landscaped median
 - Neckdowned (sidewalk bulb-outs) intersections
- In order to improve pedestrian safety, intersections should be necked down to reduce crossing widths, pedestrian refuges should be incorporated, appropriate marking and lighting should be provided at pedestrian crossings, and count-down signals should be provided at all traffic lights.
- Incorporation of gateway elements should be considered at key points to announce the entry into a neighborhood or commercial district and alert drivers to the presence of pedestrians and the need to slow down.
- Street tree planting should be used to give scale and definition to these broad corridors, and to slow traffic. Street tree locations may include sidewalk zones, parking lanes, and median strips.

- Sidewalks should be widened to provide a pedestrian zone that does not feel impinged upon by moving traffic. Pedestrian zones should include both parking and street trees as buffers between pedestrians and moving traffic.
- Bike lanes, cycle tracks, or other appropriate improvements should be incorporated to accommodate safe bicycle use.

The Avenues

The Avenues in Uptown are unique streets because they serve as important connectors between Uptown and Downtown. While they all have a similar width, the six avenues have different functions and character. First, Fourth, Fifth and Sixth avenues generally experience heavier traffic volumes due to their through connection between Downtown and Washington Street. Fourth and Fifth avenues, in particular, are unique in that they are one-way streets that function as a couplet between Downtown and the Hillcrest core. Both streets include three travel lanes and parallel parking on both sides of the street. These streets are not the most pedestrian or bicycle friendly because the one-way traffic flow and three-lane configuration results in both higher travel speeds and volumes. First and Sixth avenues, which are both two-way streets, generally have lower travel speeds. Second and Third avenues, and the north-south streets west of First Avenue, all function as wide, two-lane local streets because they do not provide through north-south connections.

The design challenge on The Avenues is to make effective use of the generally wide street cross-sections (50+ feet) to create more pedestrian-, bicycle- and transit-friendly streets while accommodating vehicular traffic.

Recommendations:

- Design solutions should be explored for the Avenues that make them more hospitable to pedestrian, bicycle and transit use while recognizing and enhancing the different functional characteristics of each street.

PUBLIC REALM | COMMERCIAL & MIXED-USE AREAS

- Enhancements to First, Fourth and Fifth Avenues should focus on: creating a more human scale to the street; enhancing pedestrian and bicycle facilities, and calming traffic. Such enhancements might include:
 - Consistent street tree planting
 - Widening of sidewalks and/or introduction of planting strips
 - Addition of bike lanes
 - Sidewalk bulb-outs at intersections
 - Addition of street furnishings to support pedestrian activity at key nodes
 - Enhanced transit stops

- Consideration should be given to how to mitigate the undifferentiated linearity of Fourth and Fifth Avenues and create a greater sense of place. Design strategies might include:
 - The introduction of gateway elements (e.g., markers, signs, etc.) at key neighborhood or commercial district entries to reinforce neighborhood or district identities
 - Changing street tree and landscape palettes along different sections of the avenues
 - The use of distinctive paving, banners, public art, etc. to distinguish neighborhoods and districts

- Enhancements to Second and Third Avenues and the north-south streets west of First should focus on narrowing the actual and/or perceived street cross-section and making more creative use of the public right-of-way to complement the residential scale and character. Such enhancements might include:
 - Consistent street tree planting, including use of canopy trees, double rows of trees, and other strategies to enhance definition and sense of enclosure
 - Widening of sidewalks
 - Addition of bike lanes
 - Addition of diagonal parking
 - Sidewalk bulb-outs at intersections
 - Narrowing of street to create streetside pocket parks or greenways



Third Avenue in Park West is characterized by a generous width and lined with palm trees.



Double rows of trees help to define sense of place along linear corridors.



Curb extension or neck-downs may be included to enhance pedestrian safety and add planting area.

Pedestrian-Oriented Retail Streets

Uptown is known for its active, vibrant, retail streets filled with pedestrians throughout the day. The Uptown's retail streets are generally continuations of streets that connect to other parts of the City, but have different dimensions and design character as they pass through the commercial district. Typically, retail streets support neighborhood retail by providing low-speed vehicular access, convenient on-street parking, wide sidewalks with pedestrian amenities, and street trees and landscaping. Narrow street widths and enhanced pedestrian crossings encourage pedestrian activity that promotes retail vitality. The best Uptown examples include sections of Fifth Avenue in Hillcrest and the north end of Park Boulevard in University Heights. While balancing travel modes is important on retail streets, the preeminent design concern is creating a physical environment that supports the pedestrian activity that is essential for successful retail.

Recommendations:

- Curb extensions should be incorporated into key intersections to reduce the crossing distance for pedestrians and to slow traffic speeds. Curb extensions can also be used independently of pedestrian crossings as traffic calming “chokers” to discourage build up in travel speeds on long blocks. In addition to slowing traffic, curb extensions increase the space available for pedestrian amenities, such as plantings and street furniture.
- Introduce diagonal parking on wide streets to provide more on-street parking and reduce travel speeds. Reverse angle (i.e., back-in) parking should be used rather than front-in angled parking. It offers many benefits. It is safer for pedestrians and cyclists. There is less danger to traffic when maneuvering it is easier for truck and rear door loading, and passengers can enter and leave the vehicle without danger from traffic. .
- Sidewalk widths should be adequate to accommodate significant pedestrian traffic, street furniture, pedestrian amenities, and a welcoming frontage zone for commercial uses. Ideally, retail streets should



Pedestrian-oriented retail in Hillcrest

have sidewalk widths of at least 15 feet, but no less than 12 feet.

- Consistent street tree planting should be introduced to key retail streets to enhance the visual character, contribute to the pedestrian scale, and contribute to street/district identity.
- Driveways and curb cuts that create conflicts with pedestrians should be eliminated or significantly restricted within core retail districts. Ideally, vehicular access should be redirected to alley access or restricted to shared mid-block access to parking structures where alley or rear access is not available.
- Crosswalk improvements that enhance the visibility and signify the importance of the pedestrian zone are encouraged. Paving materials, colors, textures and markings can be used to delineate the crosswalk area, though all crosswalk materials shall be durable and safe for pedestrian use. Special lighting—either flashing pavement markings or overhead fixtures focused upon the crosswalk—can be used to further enhance pedestrian visibility of crossings that are heavily used during evening hours. Curb extensions and flashing signals should be installed wherever mid-block crosswalks are provided.
- Retail streets should be designed to accommodate bicycle use, including in-street designations such as bike lanes, “sharrows”, and bike boxes, and off-streets facilities such as bike racks and directional signs.

Green Streets

In the Uptown, “green” streets are intended as components of both the circulation and open space systems. Their purpose is to provide linkages between the Uptown’s open space resources and provide safe pedestrian and bicycle connections to the area’s parks and open space. The design intent is to have streets that have ample facilities for pedestrians and bicyclists, a lush, park-like character, and low traffic volumes and speeds. The design character will differ depending on street characteristics. Streets preliminarily identified as possible green streets include Laurel, Spruce, and Quince in Bankers Hill – San Diego Avenue, Sunset and Juan Streets in Mission Hills – and Richmond, Vermont, and Lincoln Streets in Hillcrest and University Heights.

Recommendations:

- The opportunity should be explored for creating broad greenways (e.g., extra wide planting strip) on one or both sides of the green street by narrowing the paved street cross-section.
- Ideally, green street sidewalks should be at least 10 feet wide.
- Bike lanes should be provided on both sides of street.
- Signage should be incorporated to identify designated green streets.
- Traffic calming measures should be incorporated as needed to slow travel speeds and reduce potential for pedestrian and bicycle conflicts with motor vehicles.
- A consistent street tree planting should be introduced along each green street to create a visual connection between parks and the neighborhoods of Uptown. A double row of trees (either the same or different species) should be considered as a way of establishing the green street identity and creating a more verdant character.



Green Streets should be lushly landscaped, creating green connectors.



Green Streets should be lushly landscaped, creating green connectors between parks and neighborhoods.

- Planting strips should be designed to serve the dual purpose of “greening” the public realm and contributing to stormwater management by slowing and treating stormwater runoff. Bioswales and raingardens should be installed in planting strips when feasible.
- Plantings should be native and/or climate-appropriate species.

Bicycle Streets and Boulevards

Bicycle Streets and Boulevards are streets that facilitate bicycle mobility by providing dedicated infrastructure for the bicycle. The difference between them is primarily one of degree. Bicycle streets are designated for bike use, but only as one of multiple travel modes, while bicycle boulevards give priority to bicycles over vehicular traffic. Bicycle boulevards typically use lightly-trafficked side streets that allow bicyclists to avoid more dangerous collectors and arterials. Motorists on these routes expect to see bicyclists and therefore travel with caution. Bicycle Streets include Class III Bike Routes, which are designated with signs but include no other improvements, or they can be improved with Class II Bike Lanes. Bicycle Boulevards typically have a higher level of improvement to ensure bicycle safety.

Bicycle lanes are currently rather limited in the Uptown. The Mobility Element recommends improvements that would create an interconnected system of Bicycle Streets and Boulevards that significantly enhance bicycle riding in the Uptown as an alternative to driving.

Recommendations:

- Bicycle improvements, such as signage and bike lanes, to establish bike routes identified in the Mobility Element, should be a priority in order to provide safe and welcoming accommodation for cyclists.
- Designated Bicycle Boulevards should be identified with uniformly colored signs and bold pavement markings



Bicycle paths and lanes create designated spaces for bicycles, thereby promoting bicycle use and safety.



Primary corridors such as University Avenue in Hillcrest should receive additional improvements to make bicycling a safer option.



Bicycle boulevards are designated with prominent markings to indicate the presence of bicycle use.

Alleys in Commercial Areas

The Uptown’s alleys are an important urban design resource that can positively influence community character. Alleys in commercial districts should be used to provide access to parking and service areas for commercial buildings, reducing the need for garage entrances and curb cuts along street frontages. Currently, all of the major commercial districts are served by alleys, except for Washington Street and isolated blocks where development has been allowed to eliminate them.

Besides service access, there are other desirable functions that alleys potentially can perform. Alleys also can be designed for more than vehicular use. The Uptown’s alleys can provide access from rear parking lots to streetfront entrances either directly through alley-side entries or by means of the mid-block breezeways. They also can provide a secondary route for pedestrians and bicyclists to navigate through the commercial districts. They also could provide venues for markets, street parties, and other special events. With the addition of certain improvements, these other functions can be greatly enhanced.

Recommendations:

- New development in the Uptown’s commercial districts should create alleys if none exist, in order to provide rear service and parking access.
- Service and loading areas should be screened and gated for security, and included on-parcel, keeping the right-of-way (R.O.W.) clear.
- Trash bins should be screened from view at all times and may not intrude into the alley right-of-way.
- A program should be implemented to underground overhead utility lines in order to improve the visual character of the Uptown’s alleys.
- When alleys provide the boundary between residential and commercial uses, the location of service and loading areas should be located and/or screened to minimize potential conflicts.



Alleys in commercial areas can serve an intimate social function.



Landscaping should be included in alleys if possible, with minimal exposure of trash bins and other utilities.



Alleys should be encouraged as safe spaces for community interaction.

Parking

Parking in commercial and mixed use areas includes a combination of on-street and off-street parking. On-street parking, which is located in the public realm, is an important component of a successful commercial and mixed use district that benefits visitors, merchants, and residents, by providing convenient access to adjacent uses, buffering pedestrians from moving traffic, calming traffic speeds, and increasing pedestrian activity on the street.

On-street parking can be configured as either parallel or diagonal spaces and angled parking can be configured as either “head in” and “back in” type spaces. Both parallel and angled configurations are good solutions in the right context. Generally, parallel parking is better for higher volume streets with faster moving traffic and limited right-of-way width. Angled parking works better on slower, lower-volume streets that have ample right-of-way.

The advantage of angled parking is that it can provide more on-street parking than parallel parking can within the same length of curb. This is particularly desirable in retail areas that have “main street” type storefronts and want to generate as much street activity as possible. The disadvantages of angled parking are that it requires more street width to accommodate the angled spaces and, it can create sight distance problems associated with cars backing out of parking spaces, and can slow traffic flow.

The use of back-in (reverse) angled parking can overcome the sight distance concerns, and because of this is considered a safer solution for streets with bicyclists traveling adjacent to angled parking. However, it is a configuration that drivers are less familiar with so it requires some education and time for people to understand how it works.

Off-street parking is regulated by the Private Realm parking guidelines.

Recommendations:

- To the extent feasible, on-street parking should be provided on all streets to support adjacent uses and enhance pedestrian safety and activity.
- In order to maximize the curb side available for on-street parking, driveway curb cuts should be limited to the extent possible. The use of alleys or shared driveways should be encouraged as a way to limit curb cuts.
- On-street parking should be primarily parallel parking on high-volume arterial and collector streets. Angled parking may be used on lower-speed and lower-volume streets.
- In locations with generous street widths, explore opportunities to incorporate reverse angle (i.e., back in) parking instead of typical head-in diagonal parking to improve safety for bicyclists, calm traffic and reduce conflicts with on-coming traffic.
- Reverse (back-in) angled parking requires a wider edge zone at the outside street edge due to the longer overhang at the rear of most vehicles. This extra width can be compensated for with the narrower travel lane needed adjacent to parking for maneuvering.
- Avoid marking bicycle lanes in conjunction with front-in angled parking. Rather, provide an area six feet in width, without bike lane markings, between angled parking and the travel lane on streets heavily used by bicyclists. Bicycle lane markings may be used in conjunction with back-in angled parking.
- Use metered parking in commercial areas to provide reasonable short-term parking for retail customers and visitors while discouraging long-term resident and employee parking. Restrict time limits of 30 minutes or less to areas reserved for special, short-term, high-turnover parking such as passenger loading, convenience stores, dry cleaners, etc. Maximum time limits should not exceed 2 hours where turnover of parking spaces is important to support nearby retail business.

- Parking space widths should be dependent on the land use context and thoroughfare type, and the anticipated frequency of parking turnover. The preferred width of a parallel on-street parking lane is 7 feet.
- In areas with particularly wide streets and/or long, uninterrupted stretches of on-street parking, consider introducing street trees and other plantings within the parking lane at regular intervals along the block. Such plantings not only contribute to the visual character of the street, but can also reduce the apparent width of the street and vehicular travel speeds.
- Convenient on-street motorcycle parking should be provided in prominent, well-lit locations. Motorcycle parking bays should be striped perpendicular to the sidewalk in the on-street parking lane.
- In retail areas where pedestrian activity is heavy and sidewalk space limited, consider incorporating bicycle parking into the on-street parking lane in order to increase bicycle parking capacity and support bicycle use. Bike parking within the on-street parking lane should be delimited with bollards to protect bicycles and cyclists.



Reverse diagonal parking is a safe alternative for bicyclists and traffic.



Bicycle parking within the parking lane is ideal for accommodating bicycle racks within the public right-of-way.

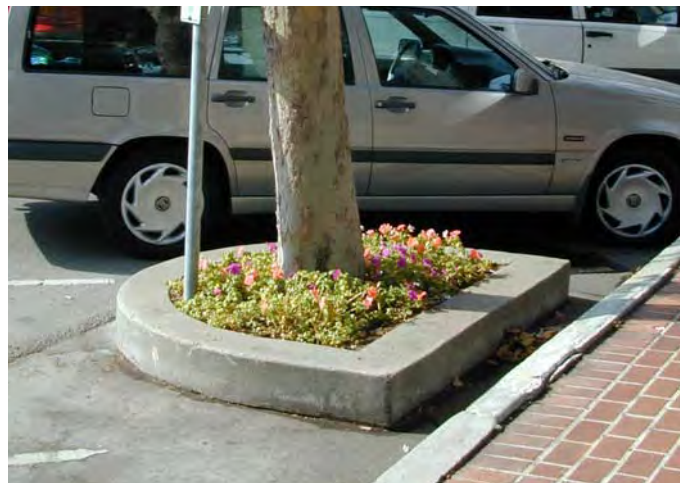

Plantings within the parking lane contribute to streets' visual character and reduce the apparent width of the street and vehicular travel speeds.

Pedestrian Improvements

Maintaining and enhancing the walkability of the Uptown is a primary concern of community members. As a result, the guidelines focus on improving the character and function of the pedestrian network in order to support walking as an appealing way of circulating within the Uptown. The guidelines recommend design strategies for enhancing the physical safety, comfort, and convenience of the pedestrian environment as well as the aesthetic character and quality of the pedestrian experience. In commercial and mixed use areas, sidewalks are the primary component of the public realm, but equally important are the pedestrian street crossings where pedestrians and motor vehicles cross paths.

Sidewalks

Sidewalks are the primary areas within the public street right-of-way that are reserved specifically for pedestrian use. They also serve as the interface between buildings and the street, providing both connection and buffer. As such, the design of the sidewalk and the elements within it are critical to the creation of an active, pedestrian-friendly environment, which in turn is essential to establishing and maintaining vibrant commercial and mixed use districts.

As part of the public right-of-way, sidewalk widths can be interpreted as a statement about the relative status given to pedestrians versus automobiles. When pedestrians are relegated to narrow sidewalks on either side of wide streets the implicit message is that the pedestrian is not as important as the automobile. Generally, the space allocated to the pedestrian and the automobile should be better balanced to achieve a more walkable Uptown. Safe, comfortable pedestrian environments will only occur where the design of the public realm balances the concerns for automobile efficiency with those for a high quality pedestrian environment.

The widths of sidewalks vary greatly within Uptown. Sidewalk widths of fourteen (14) feet are found in the Hillcrest core, while sidewalks in other commercial areas are much less.

Recommendations:

- Sidewalk widths should be commensurate with the level of pedestrian activity desired for the specific street frontage. Sidewalks generally should be wider in pedestrian-oriented commercial areas, where pedestrian activity is heaviest.
- Sidewalk widths of fourteen (14) feet or greater generally provide adequate space for pedestrian amenities, for local business activity to spill out onto the sidewalk, and for adequate space to accommodate smooth pedestrian flow. However, in the most active retail areas, wider sidewalks (e.g., up to 20 feet) may be desirable.
- Increasing sidewalk widths in fully developed areas can be difficult to achieve, requiring either

acquisition of additional space by narrowing the street cross-section or by requiring new development to implement increased setbacks.

- Curb extensions (i.e., bulb outs) at “necked-down” intersections are encouraged as a means of expanding the pedestrian zone where pedestrians are likely to congregate while waiting for transit or to cross the street.
- Within a defined district, sidewalks should maintain a consistent paving material, surface finish, and paving/scoring pattern to establish a unified character and identity.
- In instances where there is a desire to establish a distinct identity for a street or district, higher quality paving materials, such as the red brick used in the Hillcrest core, may be used for the public sidewalk as long as there is consistent application for no less than a full block face (i.e., the paving treatment should wrap around the block from alley to alley).
- Different paving materials (e.g., unit pavers, porous pavement, etc.) may be allowed in the amenity zone (i.e., the street edge), particularly if used to reduce stormwater runoff and enhance street tree health and viability. Such materials will still be required to conform to the paving pattern (e.g., 2-foot grid) established in the sidewalk pedestrian zone.

Crosswalks

Street intersections are the places where the vehicular traffic and pedestrian traffic overlap. As areas that are shared by pedestrian, bicycle, and vehicular traffic, intersections have the potential for conflict. In order to reduce potential conflict and ensure pedestrian safety, it is important that pedestrian crossings be designed as integral and critical components of the street system.

Generally, the design of pedestrian crossings should achieve at least four objectives:

- Announce the presence of a crossing zone;
- Slow vehicular traffic as it passes through the crossing zone;

PUBLIC REALM | COMMERCIAL & MIXED-USE AREAS

- Minimize the crossing time/distance for pedestrians; and
 - Demarcate a clear and unambiguous zone for pedestrians.
- The curb-to-curb crossing distance should be minimized in order to reduce pedestrian exposure to traffic. Design strategies to reduce crossing distances include reducing the number and/or width of approach lanes to an intersection, eliminating turn lanes, and reducing the radius of the intersection curb returns.
 - Curb extensions, also called bulb-outs or neckdowns, are recommended where feasible in order to reduce crossing distance for pedestrians and slow traffic speeds.
 - High visibility markings should be used to delineate pedestrian crosswalks, both to alert drivers of pedestrian presence, and to guide pedestrians to use only designated crossing points. In areas with particularly heavy pedestrian and vehicle traffic, pedestrian-activated flashing pavement markings, can be used to further enhance pedestrian visibility during evening hours.
 - Special paving treatments, such as brick, colored concrete, and pavers, should be considered in conjunction with crosswalk markings to enhance the visibility of crosswalks, improve aesthetics, and serve as a visual and tactile cue to drivers that there is pedestrian activity. All crosswalk materials should be durable, safe for pedestrian use, and stable enough to accommodate vehicle traffic without shifting or settling.
 - Pedestrian “countdown” signals (i.e., signals that show how many seconds remain to cross the street) should be installed at all signalized intersections to improve pedestrian comfort, especially at wide intersections.
 - A leading pedestrian interval should be added to signal timing to provide pedestrians with a few seconds head start into the intersection at the beginning of a green light to prioritize pedestrians over vehicles turning into the crosswalk. Curb ramps



Sidewalks in commercial and mixed-use areas should be maintained to accommodate pedestrians and promote walkability.



Pedestrian crosswalks should be designed to enhance the designated pedestrian area within the street.

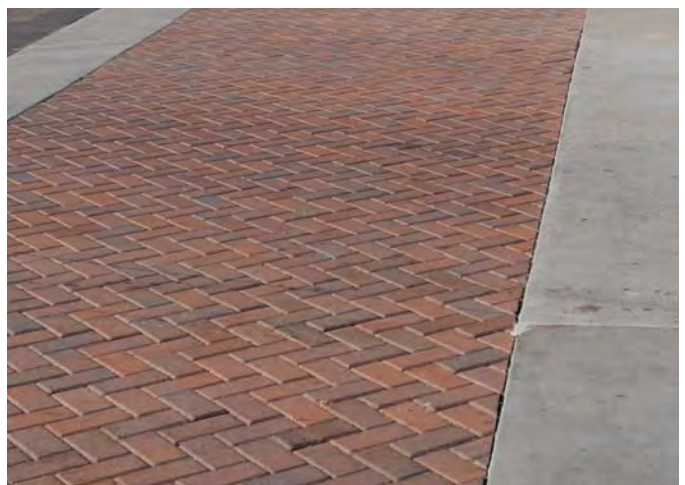

Special paving may be included at crosswalks and on sidewalks for added emphasis of the pedestrian realm.

should be provided at all intersections to assure accessibility for all users.

- Mid-block crosswalks generally are not recommended, because motorists typically are not expecting pedestrians to be crossing between intersections. Mid-block crossings should be considered only when there is significant pedestrian demand to cross a street between intersections, such as to connect two major mid-block destinations on a particularly long block. If considered, mid-block crossings need to have adequate sight distance and be appropriately signed, marked and illuminated.

Streetscape Improvements & Furnishings

As the primary public space throughout the Uptown, it is important that the pedestrian realm is managed not just for circulation purposes, but is also appropriately furnished and maintained. An attractive, well-designed public realm not only contributes to increased pedestrian activity, but also to increased community pride and sense of place. In order to transform the public streetscape from mere transportation facility to vibrant public open space, it is important to add facilities and amenities that help to animate the pedestrian



Pedestrian "countdown" signals should be installed at all signalized intersections to improve pedestrian comfort, such as Fifth Avenue.

realm, support public use, and contribute to the social and economic vitality of Uptown's neighborhoods.

General Recommendations:

- Sidewalks should be richly appointed with improvements and amenities that enhance the pedestrian experience, but should avoid clutter and congestion.
- Street furnishings generally should be located along the streetside edge of the sidewalk and not interfere with pedestrian circulation.
- Streetscape elements should maintain a consistent design character along the length of a block. At a district scale, coordinated design, type, color and material of street furniture contribute to a sense of community identity, and reflect and strengthen the local character.
- Landscaping of the public streetscape with street trees and other vegetation is encouraged as a means of adding color and visual interest, softening the urban edges, providing shade, and assisting with air quality and stormwater management.

Specific Recommendations:

Seating

- Benches and other forms of seating (e.g. low walls, planter edges, wide steps) should be provided throughout Uptown particularly in pedestrian-oriented commercial areas and near transit stops.
- Benches should be provided in sidewalks, plazas, parks, and other high pedestrian use areas to further promote pedestrian use.
- Benches should be fixed in place, constructed of durable and low-maintenance materials, and reflect the design character of the district.
- Use of individual, movable chairs, such as is done in Little Italy, is encouraged where there is an organization that is willing to manage their use (e.g.,

secure the seats at night). Such seating provides appealing flexibility that can enhance public use.

Street Lighting

- A consistent style and size of pole and fixture should be used within a given district or street to create a unifying scheme of illumination that is appropriate to the scale of the street and the level and character of nighttime activity.
- Pole and fixture design should be coordinated with other street furniture and amenities to establish an attractive and unified design character.
- The height of light fixtures generally should be kept low to establish a pedestrian-scaled environment and to minimize light spill into adjoining properties.
- Shorter light standards should be more closely spaced to provide appropriate levels of illumination.
- Light poles should include armature that allows for the hanging of banners or other amenities (e.g., hanging flower baskets, artwork, etc.).
- Street lighting should focus on illuminating the pedestrian zone (e.g., sidewalks, paseos, plazas, alleys, transit stops), rather than the vehicular zone (i.e., the street). Minimize the use of tall, cobra-head lighting to the degree possible.
- Color-balanced lamps that provide a warm white illumination and realistic color rendition are recommended.

Bicycle Racks

- Bicycle racks should be located in prominent locations that are clearly visible to cyclists from the street and from adjoining buildings and public spaces, and should be distributed at regular intervals along the length of the block for optimal convenience.
- Bicycle racks should be located so that parked bicycles do not block the travel path of pedestrians, infringe



Street furnishings should communicate a consistent overall style and aesthetic



Street lighting should be incorporated into areas of high pedestrian activity.



Bicycle racks should be durable and located outside of the pedestrian realm.

upon seating areas, or obstruct ingress and egress to parked vehicles.

- Curb extensions are good locations to site bicycle racks, as long as the facilities do not interfere with pedestrian circulation. Providing space for bicycle parking should be considered a design criterion when designing curb extensions.
- On-street vehicle parking spaces may be converted to bicycle parking in locations where space in the public amenity/furnishings zone of the sidewalk is crowded or insufficient to meet demand.
- Bicycle racks should be designed to provide a secure system that reassures bicycle owners and encourage more frequent bicycle use.
- Bicycle racks should be aesthetically coordinated with other street furnishings. They may also be an opportunity for public art, or to highlight community identity.

News Racks

- Consolidate newspaper racks into consistently designed newspaper boxes to reduce the physical and visual clutter of individually placed newspaper boxes.
- Prohibit the clustering and chaining of news boxes to trees, street signs, and utility poles.
- Newspaper racks generally should be located near intersections, and where possible, co-located with transit stops, to provide an amenity to transit riders.

Parking Meters and Public Utilities

- In order to reduce conflict with pedestrian movement and improve the aesthetic character of the public realm, utilities should be undergrounded whenever feasible, particularly on commercial streets. Undergrounding projects should maximize space available for street tree planting.
- Where practical, handholes, vaults, and other utility access points should be located out of the sidewalk area, and in the private parcel area. Above

ground utility boxes, control panels, etc. should be discouraged or located outside of the pedestrian realm of the sidewalk zone.

- In order to reduce clutter within the pedestrian zone, facilitate on-street parking, and increase parking revenues, the City should install multi-space and pay-and-display parking meters that require one meter for multiple parking spaces.

Refuse Containers

- Refuse containers should be located regularly at intersections, near major building entrances, near bus stops, and adjacent to outdoor seating areas.
- Each receptacle should accommodate recycling, prevent wind and rain from entering the container, facilitate convenient access to the liner, and have the option of being anchored to the pavement.
- Refuse containers should be consistent with the overall style and aesthetic of other street furnishings.

Tree Grates, Tree Guards, and Planting Strips

- Tree grates should be used in commercial areas and areas with high pedestrian activity to protect trees and reduce pedestrian safety hazards. In areas with lower levels of pedestrian activity, alternatives such as accent planting, decomposed granite or pavers, may be permitted instead of tree grates.
- Tree grate design and materials should reflect overall character of the street and neighborhood and be coordinated with other street furnishings.
- Grates that allow for integrated tree guards, decorative lighting, electrical fixtures and auxiliary power (for special events, holiday lighting, or maintenance) are encouraged.
- To maintain long-term health, street trees located in tree grates and/or within paved areas should be planted in a structural soil medium that extends

from the street curb to the full width of the adjacent property line or, if narrower, the extent of the mature canopy; this larger growing area improves a tree's stability and lifespan by ensuring that its roots are properly aerated and have room to grow.

- In more residential areas and areas with lighter pedestrian traffic planting strips can be used rather than tree grates.

Wayfinding Systems

- As a significant destination for visitors from near and far, consideration should be given to developing a wayfinding system that can assist both San Diego residents and out-of-town visitors in moving around the Uptown.
- An Uptown wayfinding system would:
 - Provide directional and informational signs that are attractive, clear, and consistent in theme, location, and design.
 - Identify key historic, cultural, civic, and shopping destinations and facilities, e.g. public parking structures, parks and open space areas, transit routes, etc.
 - Be co-located with other streetscape elements (e.g. lighting) where possible to reduce visual clutter.
 - Have a distinctive design that contributes to the Uptown's identity and unique sense of place.



Tree grates should be used in commercial and mixed-use areas to reflect street and neighborhood character and protect trees.



Wayfinding signage may be in the form of permanent installations or seasonal banners meant to mark neighborhood identity or events.

Street Trees

Street trees can contribute significantly to the character, identity, and comfort of the Uptown's streets. They can contribute to the spatial definition of the street, providing both a comfortable sense of scale and enclosure to the public realm. They can add shade which contributes to pedestrian comfort, and color, texture and pattern that contribute to the street's visual quality. They also can contribute to improved air quality and reduced stormwater runoff. The Uptown, which currently has a relatively limited amount of



Street trees create a positive streetscape environment and define neighborhood character, such as on Fifth Street in Hillcrest.

Recommended Street Tree Species



Mexican Fan Palm (*Washingtonia robusta*)



Jacaranda (*Jacaranda mimosifolia*)



Southern Magnolia (*Magnolia grandiflora*)



Silver Dollar Gum (*Eucalyptus polyanthemos*)

coordinated street tree planting, can benefit from a more coordinated and comprehensive street tree program. It also should be noted that while palm trees are the most frequently used street trees in Uptown, they provide only a few of the benefits frequently associated with street trees. They are good at contributing to street definition and identity, but are generally poor at achieving the other benefits listed above.

Recommendations:

- Street tree plans should be developed for each of the Uptown neighborhoods to identify a street tree planting strategy tailored to the needs and character of each neighborhood.
- Community members from each neighborhood should be engaged in the process of identifying which streets should be addressed, what the objectives for tree planting should be, and which tree species are most appropriate.
- *Neighborhood Street Tree Master Plans* will make the final determination of which particular species should be used on any given street or category of streets. Neighborhood groups should use the City of San Diego Street Tree Selection Guide as the source for tree species that are suitable for inclusion in the Master Plan. Specific trees that are on the City’s list and have been identified preliminarily due to their presence in the Uptown include:
 - Mexican Fan Palm (*Washingtonia robusta*)

- Queen Palm (*Syagrus romanzoffianum*)
- Jacaranda (*Jacaranda mimosifolia*)
- Southern Magnolia (*Magnolia grandiflora*)
- Fern Pine (*Podocarpus gracilior*)
- Silver Dollar Gum (*Eucalyptus polyanthemos*).

Note: Two species identified in the Uptown Community Plan (1988) are not on the City’s approved list: Indian Fig (*Ficus nitida*) and Lemon Scented Gum (*Eucalyptus citriodora*)

- The City should establish a Street Tree Program that supports community implementation of street tree plans once developed, and empowers community members to get actively involved in greening their own streets.
- In selecting street trees the following factors should be considered:
 - Tree species should be hearty and tolerant of urban conditions
 - Tree species should be suited to the San Diego climate and not require significant water, pesticides, or fertilizer to maintain health
 - Native or naturalized tree species provide more suitable habitat and nesting for local birds and wildlife
 - Tree species should be structurally sound, and not have weak branching habits that result in broken and falling branches

- Trees that overly messy (e.g., heavy shedding of bark, leaves or seed pods) or have invasive roots systems that can heave sidewalks or break pipes should be avoided
- Tree species need to be responsive to the particular context, and avoid potential conflicts with overhead or underground utilities, or with adjacent structures
- Broad canopy type trees should be selected for streets that are particularly wide and/or where shade is desirable
- Tree canopies should not be so dense that they obscure views of the street from upper floor windows or obstruct filtered light from reaching the pedestrian zone
- Tree species that have distinctive flowers, bark, or other special characteristic are particularly effective on pedestrian-oriented streets

- In order to establish the identity of a particular street, a single predominant species should be selected, and consistent size and spacing used to create a recognizable pattern and character.
- On streets which already have a predominant tree species, infill planting should be used to reinforce the character of the street.
- In order to support a comfortable pedestrian environment, street trees should have sufficient canopy to provide shading to the pedestrian zone. Spacing of trees will be dependent on species selected, but should be based on the ability to reasonably achieve shading of at least 50% of the public right-of-way within ten (10) years of planting, and provide a nearly continuous canopy at maturity.
- Street trees should have a high enough branching pattern and canopy—generally thirteen (13) feet or higher—so that trees do not obscure commercial signage and storefront windows or conflict with truck access.

Public Spaces, Plazas

The Uptown does not have many public plazas or open spaces within the community’s commercial and mixed use areas where people can gather or just sit and rest. These kinds of spaces can provide needed open space for nearby residents, office workers, shoppers and visitors, especially when larger parks are not proximate, as is the case in much of Uptown. Small plazas and public spaces can help offset park deficiencies by providing public gathering places that foster a sense of community. While publicly accessible, ownership and operation of these spaces can be public, private, or some form of partnership. The scale and features of these small open spaces can vary, but should be consistent with its context.

Recommendations:

- Given the limited land resources within the developed commercial areas, the community should explore creative ways to create small public spaces such as the re-purposing of underutilized utility easements, extra-wide street rights-of-way, and undevelopable remnant parcels to create usable open space.
- Given the need for public open space in the most densely developed areas and areas that are most likely to redevelop, the City should explore the possibility of offering incentives to new development in exchange for the creation of publicly accessible open space in the form of plazas, courtyards, and pocket parks. Possible



Plazas, which provide transition areas between the public and private realms, should be accessible and oriented towards the public realm.

incentives might include mechanisms such as density or height bonuses.

- Public spaces should be oriented towards the public right-of-way and be bounded by active building facades (e.g., entrances, windows, balconies, etc.) that help activate the space and provide “eyes on the street” for security.
- Public spaces should be designed with optimal year-round sun exposure and out of the path of prevailing winds.
- Public spaces should be accessible to all user groups, including those with disabilities.
- Public spaces should include ample seating areas and spaces for social interaction.
- Landscaped areas within public open space should be designed with climate-appropriate plant materials and reflect the native or historically significant plants of San Diego.

designed to treat and attenuate stormwater flow is encouraged whenever feasible as a means of reducing stormwater runoff rates and volumes. The City’s Stormwater Standards manual should be referenced for further guidance.

- In order to conserve energy and reduce long-term costs, energy-efficient strategies should be implemented for public utilities, including:
 - Use of LED or Energy Star-certified lamps for all public realm lighting;
 - Monitoring and limiting hours of illumination in public realm lighting to avoid waste;
 - Incorporation of features such as solar panels and LED lights in transit shelters;
 - Installation of pay-and-display solar powered parking meters throughout the Uptown.

Sustainable Infrastructure

Sustainable design is encouraged throughout Uptown. In the public realm, sustainability guidelines apply to landscape and hardscape, and are related to an overall approach to providing sustainable infrastructure. All improvements in the public realm should contribute to a more energy and resource efficient future.

Recommendations:

- Reuse and recycling of construction and demolition materials is recommended for all new public realm construction.
- Use of materials from renewable sources is highly encouraged.
- Regional and drought-resistant plant species should be used for landscaping to reduce water consumption.
- The use of permeable or porous paving and landscape



Permeable paving treatments are encouraged in areas of the public realm in both new construction and existing development.



Public realm landscaping is encouraged to reduce stormwater runoff and reduce the build-up of the urban heat island effect.

- Street tree planting and other public realm landscaping is encouraged as a strategy for:
 - Reducing the build-up of surface temperatures in paving and buildings (i.e., the “urban heat island effect”) and resulting need for air conditioning by shading heat absorptive surfaces.
 - Reducing stormwater runoff and improving water quality through the combination of foliage cover, pervious surfaces, and evapotranspiration.
 - Improving air quality by removing carbon dioxide (CO2), other gaseous pollutants, and particulate matter from the atmosphere.



Public art should be incorporated into elements of the public realm that are well-used and viewed by the community.

Public Art

Public art helps to activate the public realm by adding visual interest to the public streetscape and enriching the pedestrian experience. Adding elements that visually and intellectually engage the community can be an effective means of encouraging pedestrian activity and fostering community identity. However, given the competition for space in the pedestrian realm, it is important that public art be seen as more than just statues or sculpture that occupy space. Instead, public art should be seen as something that is integral to the design of the many elements that occupy the public streetscape--making them more interesting, but not necessarily requiring more space.

Recommendations:

- All capital improvement and development projects should explore the integration of public art into the design of public streetscape elements (e.g. paving, street furniture, transit shelters, lighting, etc.)
- Public art should be located where it can be viewed and enjoyed by a large number of people, including sidewalks, intersections, plazas, and medians.
- Public art should be used to enhance community understanding of Uptown’s history and culture.
- The design and placement of public art should enhance



Public art may be incorporated into community gateways.

and be coordinated with other streetscape elements. Three-dimensional installations that occur within the public right-of-way should not obstruct pedestrian circulation, and should be considered in the same manner as other street furnishings.

- Public art may be used to mark key gateways and intersections, e.g., the Hillcrest Core, Park Boulevard.
- Interactive art, that encourages community participation or provides sensory stimulation through touch, movement, or sound, is encouraged, but should be located where it will not obstruct pedestrian movement or create a nuisance .
- The work of local San Diego artists should be highlighted through public art installations.

PRIVATE REALM

The “private realm” is the term used to describe the portion of the built environment that is occupied by buildings and associated improvements. The private realm is generally under private ownership, but it also includes publicly-owned property that is developed (e.g., UCSD Medical Center, California DMV, etc.). Whereas the primary concern in the public realm is the design of public spaces and rights-of-way, building design is the focus in the private realm. Given the programmatic diversity and higher densities that typify the Uptown’s commercial and mixed use areas, buildings tend to be both larger and more diverse in character, compared to the Uptown’s residential areas, and thus have a more significant impact on community character.

- **Scale:** Relate the bulk of new buildings to the prevailing scale of development to avoid an overwhelming or dominating appearance in new construction.
- **Pedestrian:** Encourage building design that helps activate and define the public realm and enhance the pedestrian experience.
- **Materials:** Promote the use of high quality building materials, detailing & landscaping.
- **Integrated Services:** Promote functional & aesthetic integration of building services, vehicular access and parking facilities.
- **Sustainable Design:** Promote sustainability in building design, construction and operation.

Generally, the guidelines for Private Realm are based on the following objectives:

- **Context:** Allow for creative architectural solutions that acknowledge contextual design through emulation, interpretation, or contrast in character.
- **Character:** Complement the architectural character of existing historic buildings and promote harmony in the visual relationships and transitions between new and older buildings.



Diagram of Public vs. Private Realm

Site Planning and Block Structure

Since most of the future development in Uptown will be infill, it is important that it be consistent with the context of the community. This begins with site planning, and defining the relationship that buildings have with the public realm. While development in many parts of Uptown create an appealingly consistent and well-defined street edge, others are more inconsistent, frequently occupied by unsightly parking lots. The building's relationship to its site and to the public street is critical to create an active and vibrant public realm.

Guidelines pertaining to Site Planning and Block Structure include:

1. Orientation to the Street
2. Setbacks
3. Lot Coverage
4. Landscaping and Open Space
5. Project Size & Building Type
6. Site Access, Service Areas and Utilities

Typical Uptown Blocks

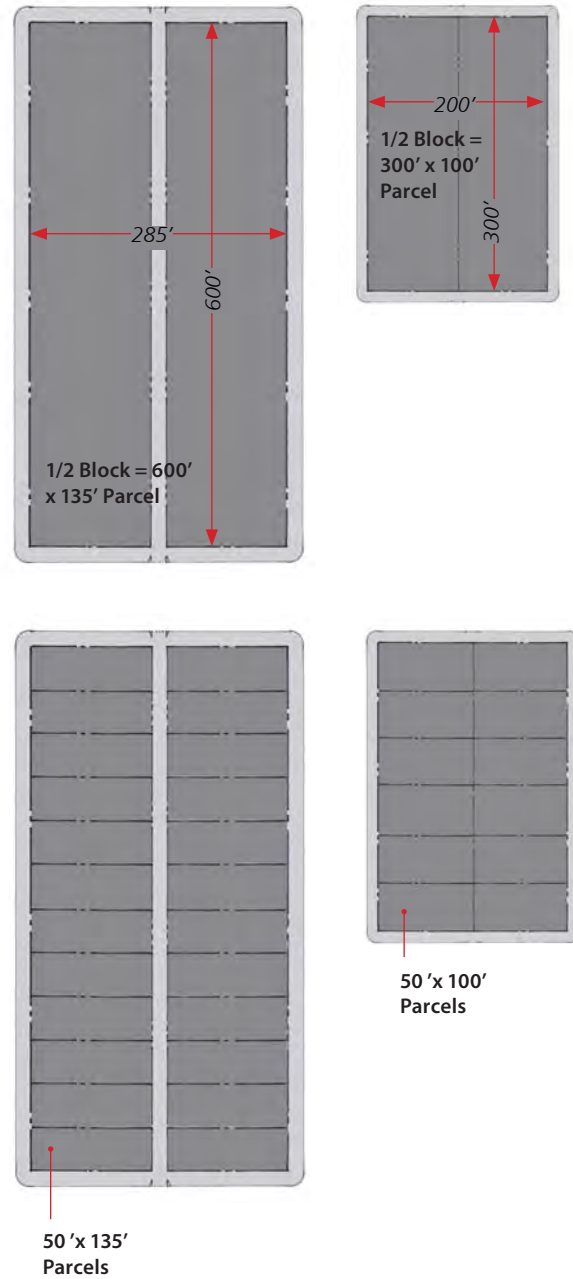

Although there are many different block configurations in Uptown, two block configurations established in the area's early history predominate. A long, narrow block with mid-block alley predominates in Hillcrest and University Heights. A shorter block without an alley predominates in Park West.

Orientation to the Street

Much of Uptown's vibrant pedestrian-oriented environment is a product of development in the late nineteenth and early twentieth centuries, prior to the prominence of the automobile, when buildings were designed at a more pedestrian scale and sited to address the public realm, creating a well-defined street edge. In later generations, in response to changes in transportation choices, retail formats, and construction technologies, this consistent edge was eroded by parking lots, driveways, and buildings set far back from the street. The intention of the urban design guidelines Plan is to reinforce the pedestrian scale and orientation that typifies the Uptown's historic grain and infill the missing pieces of the street edge.

Recommendations:

- Buildings should be oriented towards the street to positively define the public street, aligning with primary street frontages and public spaces to frame the pedestrian environment.
- The main building entrance should be located on the primary street frontage.
- Primary building entrances shall not orient to parking lots at the expense of street frontages.
- All building facades that face streets or are adjacent to sidewalks or pedestrian pathways (e.g., paseos) shall incorporate elements such as windows, doors and other architectural elements that activate the facades and provide visual interest.
- Buildings shall be designed to maintain quality architectural articulation and finishes around all visible sides of the buildings, not just the front.



Historic buildings in Uptown have a strong orientation to the street.

Setbacks

The distance buildings are setback from the street helps to define the character of the public realm. In order to create a coherent character, it is important to establish a consistent alignment of building frontages without significant gaps. Building setbacks and build-to lines are the tools used to establish a consistent street wall. In residential areas, a wider setback is appropriate, where a landscaped zone between the building and the back edge of the sidewalk provides a privacy buffer. In Commercial and Mixed-Use areas, buildings should be closer to the street to define and engage the pedestrian environment.

Within Uptown, the established setback standards have been between 0 and 10 feet in Commercial and Mixed-Use areas, although the built environment does not necessarily reflect these dimensions. Current setbacks are shown in Figure 3: Setbacks.

Recommendations:

- In order to create a consistent and well-defined street frontage, buildings in commercial and mixed use areas should be set up to the street and built to either an agreed upon minimum setback line or to the prevailing setback along the street.

- In no instance should surface parking be allowed to be located between the building frontage and the public street right-of-way.
- Given that sidewalk widths in some of the Uptown commercial areas are under-sized to support an active and well-furnished pedestrian environment, minimum setbacks should be established that contribute to a wider pedestrian zone. For example, on commercial streets that currently have 8-foot wide sidewalks, a minimum 4-foot front yard setback could be established to achieve a more desirable 12-foot wide sidewalk.
- An exception to required setbacks can be made to accommodate the creation of public or semi-public spaces such as plazas, courtyards, forecourts, and sidewalk cafes, adjacent to the public right-of-way.
- In commercial areas, the rule of thumb is that at least 80% of the building frontage should be set up to the minimum setback line. In mixed use areas that are not primarily retail districts, at least 65% of the building should be set up to the minimum setback line.
- In order to create more interesting facades, minor variations in the building frontage are allowed, and will be credited toward the minimum setback percentage requirement. Minor variations include recessed building entries, vertical recesses up to three feet deep and four feet wide, and building setbacks up to 2 feet from the minimum setback line.
- In mixed use areas that are not primarily retail districts (e.g., Fifth Avenue in Park West) buildings should be placed within 3 feet of the minimum setback in order to allow for landscaping along the building frontage.

Examples of Building Setbacks

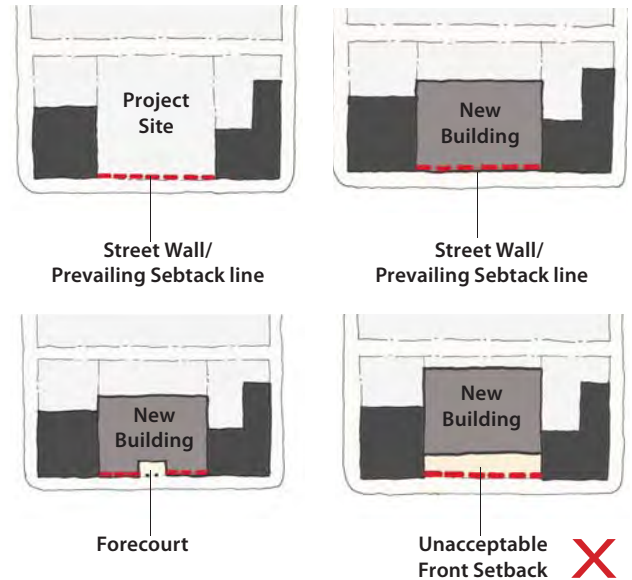

Diagrams illustrating the placement of a building in relation to the Build-to Line.

Design of the Setback Examples



Zero-foot setback.

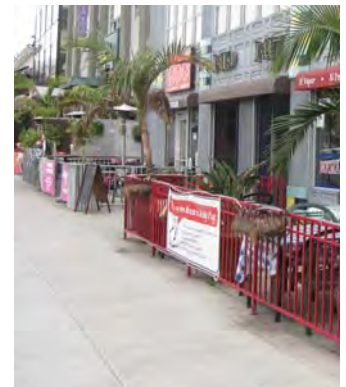

6-10 foot setback with outdoor seating.



10-15 foot setback with seating within setback zone.



Forecourt within zero-foot setback zone.

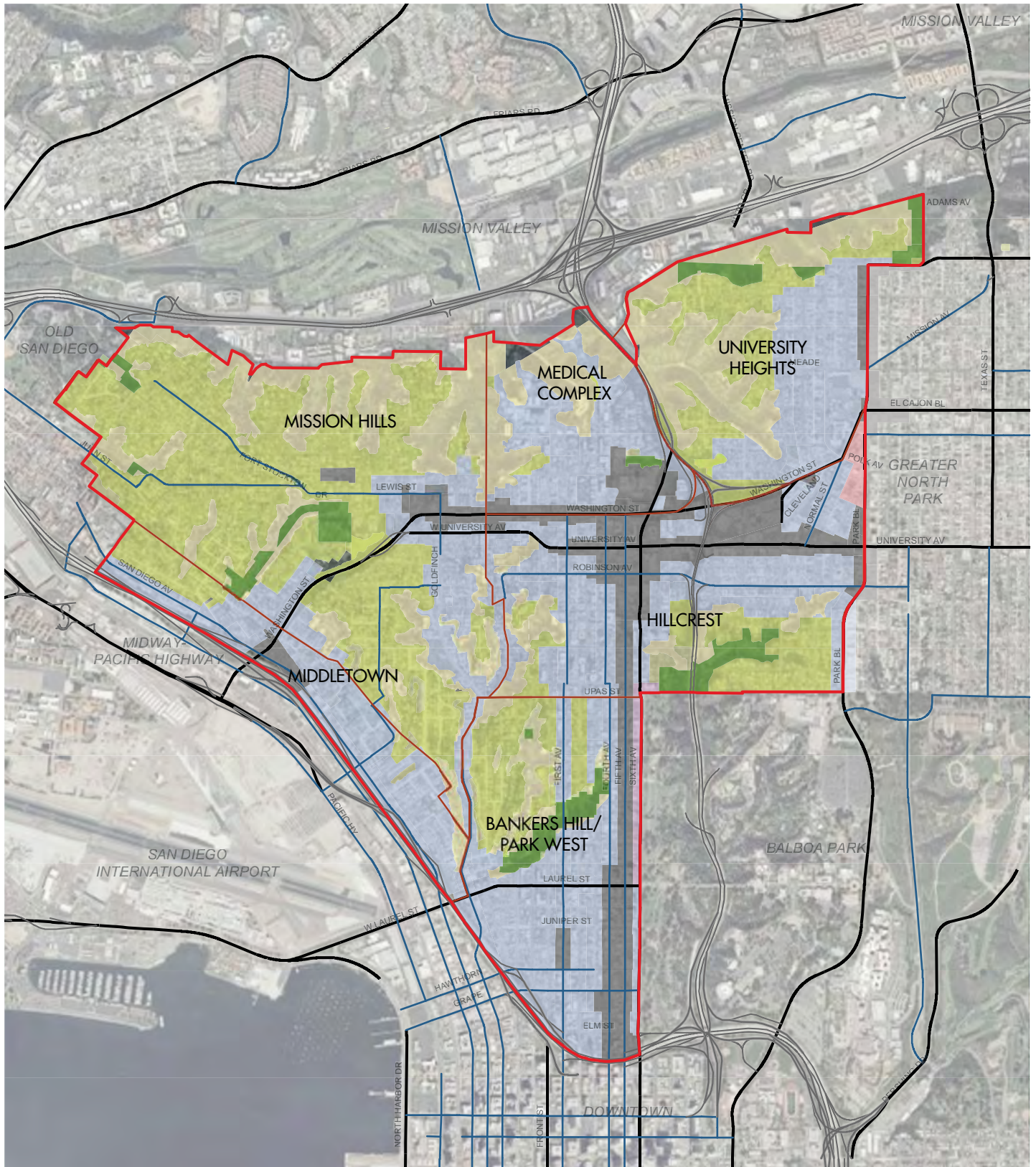

LEGEND	Roads	Setbacks	Mixed Commercial	Residential	
	— Interstate	◆ None Required	◆ 5 Feet	◆ 15 Feet	□ Community Plan Boundary
	— Minor Arterial	◆ 6 Feet	◆ 10 Feet	◆ 20 Feet	□ Neighborhood Boundary
	— Major Collector			◆ 25 Feet	
				◆ Open Space	

FIGURE 3: SETBACKS

Landscaping and Open Spaces

Landscaping plays a significant role in the user’s experience, providing the interface between the public and private realms that unites them into a seamless whole. This includes plantings along building street frontages as well as in interior courtyards, plazas and paseos. While landscaping plays a significant role in residentially-oriented mixed-use areas, it is also important in commercial areas where creating comfortable and attractive places for people is critical to successful retailing. Landscape and open space plays an important role in a number of residential and commercial building typologies that are typical to the Uptown’s temperate climate, including courtyard housing where units are oriented around a central open space and retail development organized around plazas and paseos. The inclusion of landscaping on both building frontages and within courtyards is important for achieving the aesthetic quality that is desired for future developments in Uptown.

Recommendations:

- Landscaping should be used to activate building facades, soften building contours, highlight important architectural features, screen less attractive elements, provide shade, and add color, texture, and visual interest.
- Landscape materials should be of high quality and suitable for the San Diego climate. Low-water use plant species are preferred.
- The creation of semi-public outdoor spaces such as on-site plazas, patios, courtyards, paseos, terraces and gardens that support pedestrian activity and community interaction is strongly encouraged, particularly in larger projects.
- Plazas and courtyards should be well-defined by buildings and landscaping, comfortably scaled, landscaped for shade and ornament, furnished with areas for sitting, and lighted for evening use. Courtyards should be defined by active facades or landscape treatments.



Low walls used to line landscaping and open space may be used as seating areas.



Semi-public outdoor spaces such as courtyards and paseos are strongly encouraged to foster community interaction within private developments.

- A variety of seating options should be provided, such as benches, seat walls, and broad steps. Private patios may be located in courtyards if they are defined by a low wall or hedge.
- Whenever feasible, landscaped and private open space areas should be designed to serve a sustainable infrastructure function by collecting and treating stormwater flow, allowing for infiltration and being used for irrigation.

Site Access, Service Areas, and Utilities

In order to maintain an attractive pedestrian-friendly environment in the Uptown’s commercial and mixed use areas, the location of building elements related to service access, mechanical equipment and utilities need to be carefully designed to ensure functionality while minimizing adverse impacts. Generally the objective is to make these required program elements as visually and physically unobtrusive as possible.

Recommendations:

- Service, loading, and storage areas should generally be located away from public streets and spaces, preferably at the rear or interior of a development.
- To the degree possible, service access to commercial and mixed-use buildings should be provided from alleys or, where an alley does not exist, from secondary streets.
- Service facilities and access should be visually screened from adjacent uses to minimize the potential for undesirable impacts.
- Utilities and mechanical connections (e.g., back-flow preventors, utility boxes, etc.) should be located to minimize their visibility from public areas. Whenever possible, such facilities should be integrated into the design of the building or site. If located in the landscape, utilities should be screened and not allowed to “float” as exposed, free-standing elements.



Utility hook-ups should be kept out of the public realm and landscaped to conceal them.

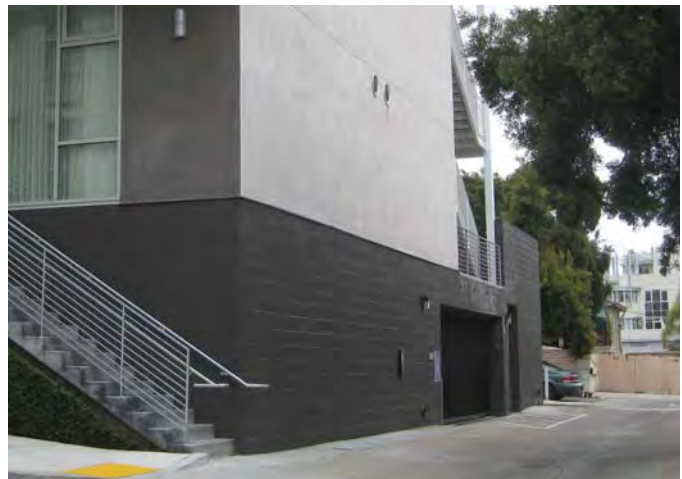

Entrances to service, loading, and storage areas should be limited to alleys and kept within the rear of development.

Overall Building Design Guidelines

Uptown contains a variety of buildings in its commercial and mixed-use areas. Buildings range in scale, style, use, and material—among other attributes—which has allowed Uptown to develop into the eclectic, diverse area that it is today. Although many design guidelines must be particular to scale and type, other broadly-based principles of good design for urban areas can be applied. The following guidelines apply to all Commercial and Mixed-Use buildings within Uptown.

Building Massing and Height Transitions

The Uptown’s popularity as a place to live, work and recreate continues to stimulate demand for new commercial and mixed use development. In order to meet demand for housing and commercial space and cover high land costs, new development is generally both larger and higher

intensity than what preceded it. This dynamic has resulted in community concerns regarding building height and massing and the associated effects they have on community character. While the commercial and mixed use areas are zoned to accommodate such increases in height and density there is still a need for new development to be sensitive to its surrounding context particularly as it relates to building scale at the street and the transition between different uses types and height zones.

Recommendations:

- Building scale and massing should be sensitive to the scale of surrounding uses.
- A combination of building setbacks, upper-story setbacks, and articulated sub-volumes should be employed to sensitively transition to adjacent lower height buildings (to the side or rear).

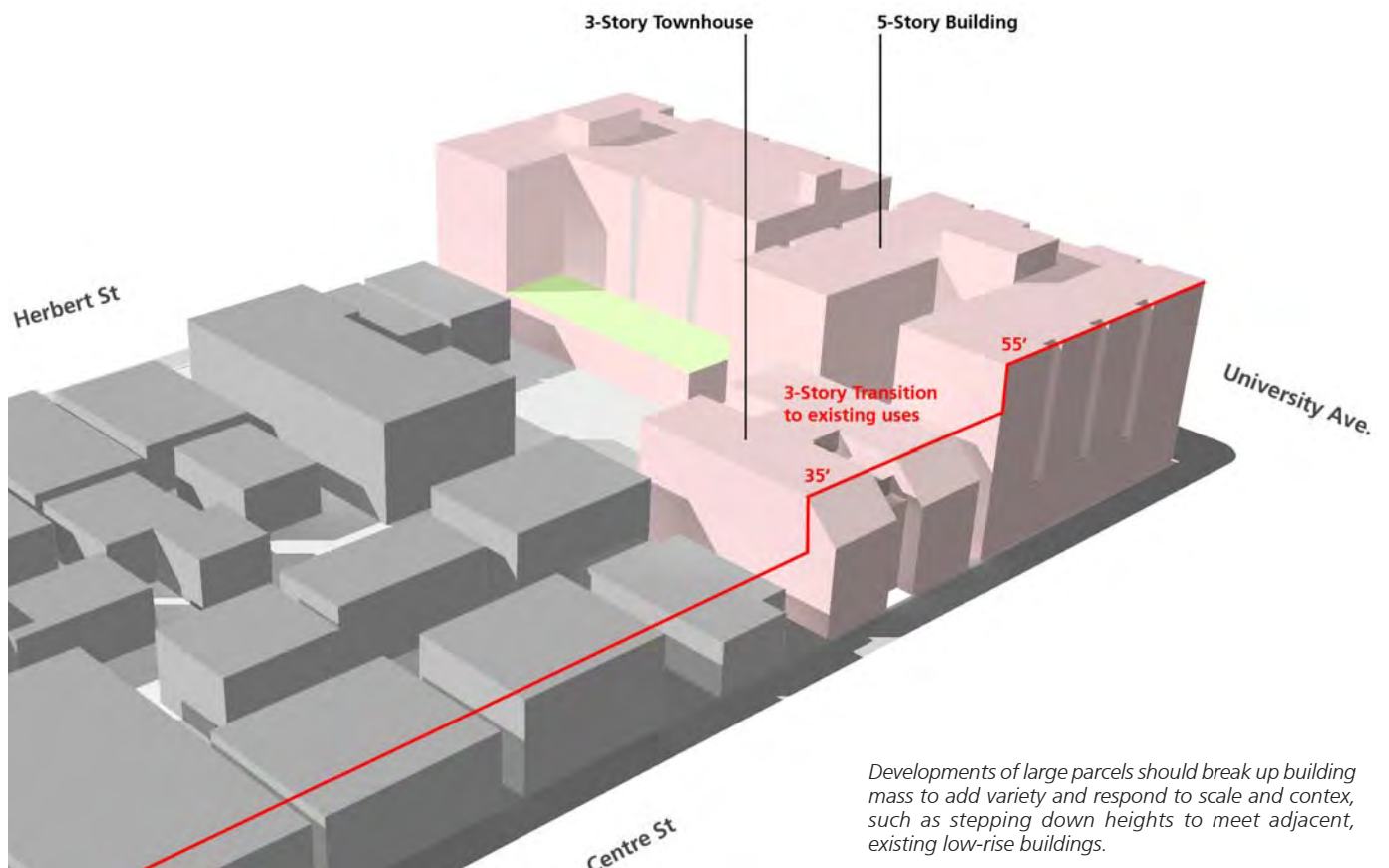

Developments of large parcels should break up building mass to add variety and respond to scale and context, such as stepping down heights to meet adjacent, existing low-rise buildings.

- In areas identified for transition to higher intensity development, height transitions need to consider factors such as the quality of adjacent buildings, likelihood of change, and building heights allowed under zoning.
- In order to maintain a pedestrian scale to the Uptown's retail streets, upper floors of buildings generally should be stepped back above the third story (35'), although on wider streets, such as Washington Street, a four- to five-story street wall may be acceptable depending on context.
- Buildings should generally be designed with simple, yet varied, massing, and utilize features, such as streetwall indents, deep entry and window openings, balconies, window bays, and a top treatment (i.e. a roof, cornice or parapet) to add variety and interest.
- In order to reduce the apparent mass, taller buildings should be designed to differentiate between the building's base, middle and top sections.
- Building massing and façade articulation should contribute to a fine-grained, pedestrian scale environment at the street level.



Creating graceful transitions between buildings of differing scales is key to achieving context-sensitive infill development.

Articulation of Street Wall

The blocks in the Uptown's commercial and mixed use areas were historically platted with 50' wide lot increments. This historic lot pattern gives the development on these blocks a fine-grained pattern with its own rhythm and built-in variety. Given the long, 600' blocks in Hillcrest and University Heights, it is important that variety in the street wall be maintained and enhanced to avoid long, boring façades. Articulation of building facades is key to creating visual interest and maintaining the pedestrian scale that is important to these district's success.

Recommendations:

- Avoid uninterrupted blank walls along all building facades. The unbroken length of a façade generally should be no greater than 25'.
- Articulation of building facades should respond to multiples of 50' (including 25') to reinforce the fine-grained pattern established by the underlying historic lot pattern.
- Façade articulation should include notched setbacks, projecting bays, balconies, etc., and should begin at the second or third floor.
- Variation in the street façade should be at least 2 to 4 feet to read as substantial change in the façade (i.e., provide a significant shadow line).
- A project should not repeat the same wall surface design horizontally more than 1/3 block and vertically, more than 50% of its floors.
- Combine changes in depth or horizontal plane with a change in material and character. Changes in façade material or color should be associated with a change in plane or separated by a pilaster.
- While the majority of the building is required to be built to the build-to line, important street wall variation can be created with elements such as recessed storefront entrances, sidewalk cafes, and pedestrian passages.

PRIVATE REALM | COMMERCIAL & MIXED-USE AREAS

- The use of vertical volumes (e.g., towers, gables, etc.) and changes in height is encouraged to break up long facades, provide focal features, and identify key locations (e.g., building entrances, entry to a paseo, street corners, etc.).



Vertical building articulation elements help to break up building mass and convey a fine urban grain.



Ground-floor uses should be active, on level with the sidewalk, and punctuated with design elements that are in scale with the pedestrian realm.

Ground Level Uses

The ground level use of buildings plays a significant role in the vitality of the public realm because they generate pedestrian traffic. In order to promote vibrant commercial and mixed use areas in the Uptown, it is important that commercial, residential, and community uses that actively engage the public streetscape are encouraged as ground-floor uses.

Recommendations:

- In the commercial and mixed-use areas of Uptown, ground-floor uses should be active and pedestrian-oriented. Uses that have little need for walk-in traffic should be discouraged from locating in street-front locations.
- Buildings with retail, commercial, community or public uses on the ground floor should have a clear floor-to-ceiling height of at least 15’.
- Ground-floor elevations for commercial uses should generally be level with the elevation of the adjacent public sidewalk, and not more than 2’ above the sidewalk grade.
- Ground-floor residential uses should provide a grade change of at least two to three feet from the public sidewalk to the first floor residence, to protect the privacy of residential units.
- In order to promote active residential street frontages, ground-floor units should front onto and take direct access from the street, rather than having shared a shared entry and access from interior corridors.
- Ground-floor residential uses are discouraged in commercial areas.

Transparency

Transparency refers to the amount of glazing (i.e., windows) on a building façade. Transparency at the street level plays a significant role in supporting an active pedestrian environment by creating a direct connection between public and private realms and engaging the interest of passersby. Storefront windows activate and add visual interest to the pedestrian environment by displaying products and revealing activity within shops and restaurants. They also contribute to public safety by creating “eyes on the street”.

Recommendations:

- Street-level facades should incorporate generous windows and street-oriented glazing that provide a high degree of transparency along the street.
- Where retail or other community or active uses occur, the street level façade should be 60-75% transparent.
- Clear, non-reflective glass should be utilized. Opaque, translucent or reflective glass does not count towards transparency ratio.
- Front doors into retail or other pedestrian-oriented ground-floor uses should include windows that permit views into the establishment.
- Blank walls should not be greater than 12 feet in length. If unavoidable, they should be landscaped or decorated in a manner that makes them visually interesting.



Transparency enhances the blending of building interiors and exteriors.

Corners

Buildings located on corners are especially positioned to address the public realm and enhance the pedestrian environment. Corner buildings draw activity from four directions and are ideally situated for active ground-floor uses. They also offer the opportunity to define street character with bold architecture or place-making features.

Recommendations:

- Buildings on corner lots should locate their entrances at the corner to anchor the intersection and create a seamless transition that captures pedestrian activity from both street frontages.
- Corner buildings should accentuate the corner’s unique location with architectural features that actively engage the public realm and create a visual presence at the corner, such as:
 - Chamfered or rounded corners
 - Projecting and recessed balconies and entrances
 - Accentuating features such as embellished doorways and volumetric manipulations (e.g., corner tower)



Buildings situated on corners may include entrances in the corner area.

Fenestration

Fenestration, which is the arrangement, proportioning, and design of windows, is important in creating active building facades that are visually engaging and in connecting a building’s interior activities with those outside it. From the outside, windows give human scale to buildings, and animate facades with their varying sizes, patterns and treatments. From the inside, they provide for natural light and views, and operable windows provide for natural ventilation. Windows should be used as an element which helps to articulate the character of a façade, and designed to reveal the thickness/depth of the façade wall. Windows should be well-proportioned and operable where appropriate.

Recommendations:

- The placement and hierarchy of windows should have a design and scale appropriate to the building.
- Windows should be grouped to establish rhythms across the façade and hierarchies at important places on the façade.
- Windows should be included along all walls visible from the public realm. Blank walls should be avoided.
- Windows should not be flush with the exterior wall surface. Window glass should be recessed a minimum of three (3) inches from the exterior wall surface to add relief to the wall surface. Wainscoting and reveals can also be used to enhance the appearance of deep-set windows.
- Generally, all occupied rooms should have operable windows to allow for natural ventilation.



Windows should be grouped to establish rhythms across the façade.

Projections

Projections refer to architectural elements, such as cornices, balconies, window bays, and sun shades, that may extend into the setback zone. Typically these are placed at a height or distance from the street frontage that they do not impact pedestrian movement, however, they must be designed carefully to ensure that their scale and location is appropriate. The following guidelines apply to individual types of projections. Signage – which may also be a projection – is covered in the “Signage” section. All encroachments shall require an encroachment agreement with the City of San Diego Public Works Department.

Recommendations:

- **Canopies and Awnings:** Canopies and awnings are encouraged to protect pedestrians from summer heat and winter rain, and to contribute variety to storefronts and building entries. Generally canopies

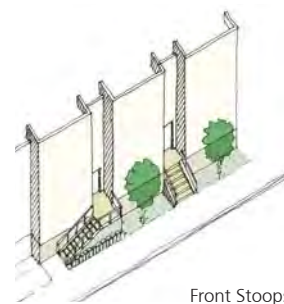
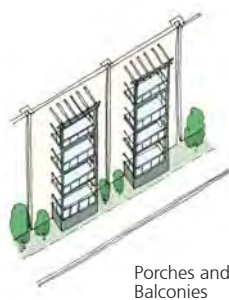
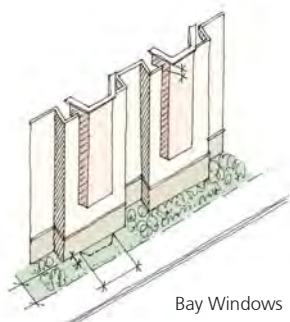

and awnings::

- Should provide 8’ minimum clearance above the finished sidewalk grade
- Can encroach into the public right-of-way up to 75% of the sidewalk width
- Should be consistent with the building’s architectural style and avoid obscuring distinctive architectural features
- Can be either permanent architectural features that incorporate materials consistent with the building’s architecture, or colored fabric mounted over a metal structural frame
- Avoid using shiny, flimsy or internally illuminated fabric.

- **Window Bays:** Window bays can add visual variety and interest to building facades and enhance the connection between public and private realms.

Generally window bays:

- Can be either squared-off or have angled returns
- Should encroach no more than 3’ into the public right-of-way
- Should have a maximum horizontal width of 8’ (The angled return is in addition to the 8’ width)
- Should have at least a 6’ horizontal separation between window bays
- Should allow at least 12’ clear from top of sidewalk to underside of projection.

- **Balconies:** Like window bays, balconies can add visual variety and interest to building facades, but they are particularly effective at creating an active connection between public and private realms.

Generally balconies:

- Should encroach no more than 3’ into the public right-of-way
- Should have a maximum 12’ horizontal width
- Should have at least a 10’ horizontal separation between balconies
- Should allow at least 12’ vertical clearance from the sidewalk

- **Cornices:** Cornices, which are continuous horizontal



Projecting balconies add visual interest, potential occupable space, and echo San Diego’s modern architectural heritage.



Sunshades may be included on upper stories or lower stories to shield solar rays into building interiors.



Awnings, canopies, and cornices add pedestrian scale to buildings.

courses or mouldings applied along the top of building facades, help to define and add character to buildings. Generally, cornices:

- Should be used to create a consistent relationship between new and old buildings by establishing a consistent street wall height along the length of the street
- Should be used reflect changes in building form such as building setbacks
- Should be of substantial depth to create a shadow line that clearly defines the top of the façade
- Should not project more than 5' into the public right-of-way.

- **Sunshades:** Sunshades are architectural features employed to control solar exposure into building interiors in order to limit heat gain, prevent glare, and enhance daylighting by re-directing and deflecting sunlight. With the emphasis on creating more sustainable buildings, the use of sunshades is expected to become ever more prevalent. Generally, sunshades:

- Are encouraged as a way to improve building comfort and energy efficiency
- Should be constructed of high-quality, durable materials
- Should be designed as an integral element of the overall building design that adds architectural distinction.

Materials

A frequently expressed desire from the community was to create new buildings that reflect the concern for craftsmanship that is embodied in the Uptown's historic buildings. While construction techniques are unlikely to replicate the hand-crafted quality of the past, the use of high quality materials is essential for creating buildings that convey the sense of quality and permanence desired for the Uptown.

Recommendations:

- High-quality, durable materials should be used in all projects. Use of such materials is especially important at the street-level (to a height of 20') where they are more visible to the public. Stone, tile, terra cotta, brick, metal and glass are examples of high quality materials.
- New developments should respond in a compatible manner to the existing color, texture and materials used on surrounding significant buildings.
- Buildings should have compatible materials on all four sides of the structure.
- Materials and colors should be related to masses and volumes. Changes in material or color should be designed with a change in the wall plane. Materials

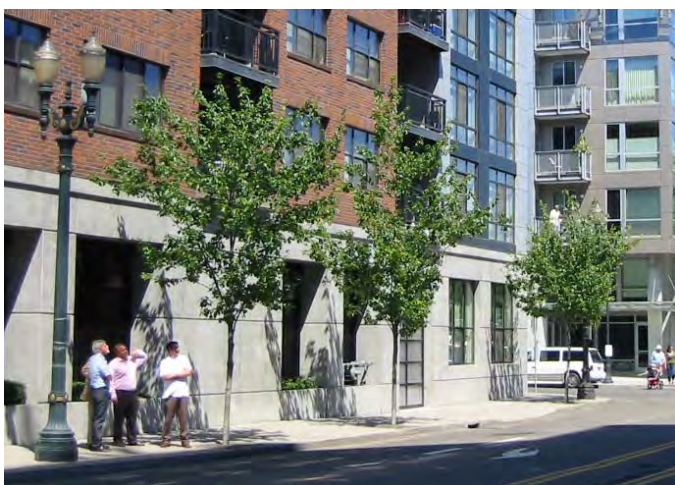

Materials may be distinct between ground-floor and upper story facades. High-quality materials should be used adjacent to the pedestrian right-of-way.



Materials should be selected that complement and respond to San Diego's climate and maximize views and natural light and ventilation.

should wrap corners and continue at least 12 inches before a change in material.

- Sustainable, local and rapidly-renewable materials should be incorporated to the extent feasible and if compatible with overall design strategy.
- Building materials and colors should be used to unify and provide visual interest to building exteriors, but the number of materials and colors generally should be limited to promote a visual simplicity and harmony.
- Residential projects should avoid the excessive use of metal, concrete, and concrete block, on walls.



Lighting of buildings should be intergrated into the building design and employ fixtures that reflect overall design approach.

Lighting

The Uptown's night life is an important component of its identity and its economic vitality. Thus, the manner in which it is illuminated is critical to maintaining community character, user comfort, and successful businesses. In addition to streetscape lighting, the illumination of building facades, landscaping and open space areas in the private realm can contribute significantly to the Uptown's general appeal, as well as its security



Lighting should enhance building features and materials, while minimizing light trespass and providing appropriate levels of illumination.

Recommendations:

- Lighting should be used to add drama and character to buildings and landscape, ensure public safety, and enhance nighttime activities.
- Lighting should be designed as an integral part of the building that is consistent with its architectural character.
- Levels of illumination should be responsive to the type and level of anticipated activity without under- or over-illuminating. Generally, higher illumination is desired on buildings and areas with higher levels of nighttime use.
- Unnecessary glare should be avoided. Buildings and landscaping can be illuminated indirectly by concealing light features within buildings and landscaping to highlight attractive features and avoid light spillage onto neighboring properties. Building-mounted lighting should be angled downwards or include cut-off shields.
- In pedestrian-oriented areas, energy efficient lighting sources with warm white color and good color rendition are recommended.
- Electric sources should be concealed and not conflict with architectural detailing.

Signage

Commercial signs play a very fundamental role. They facilitate local commerce by identifying where goods, services, and entertainment can be found. They also play a significant role in community character—contributing to either a more attractive and legible urban environment or one that is confusing, visually cluttered and unattractive. In the Uptown, as elsewhere, the conflict is between signs scaled for pedestrians versus signs scaled for motorists. In order to reinforce the Uptown’s pedestrian orientation, the type, size, and placement of signs is important. The inclusion of attractive, distinctive, and noticeable signage that is complementary to neighborhood character is a primary goal of private realm building design.

Recommendations:

- Signs in the Uptown should generally be scaled for pedestrian, rather than vehicular traffic.
- Signs should generally not be located more than 20’ above the sidewalk or be higher than the building cornice line or street wall height.
- Billboards are not consistent with the character of Uptown and should be phased out.

- The types of signs encouraged in the Uptown are:
 - Wall signs
 - Window signs
 - Projecting or blade signs (oriented vertically or horizontally)
 - Panel or plaque signs (Flush-mounted)
 - Printed signage on awnings or canopies
 - Individual lettering (three-dimensional, flush-mounted) channel
- Types of signs that are discouraged in the Uptown include:
 - Internally-illuminated acrylic box signs
 - Internally-illuminated vinyl awnings
 - Animated and rotating signs
 - Pole signs



Signs should be integrated with overall building design with a simple and clear message.



Signs should be integrated with overall building design with a simple and clear message.



Printed signage on awnings or canopies is an encouraged form of signage in the Uptown District.

- Signs should be constructed of high-quality materials such as wood, metal, or stone.
- Sign messages should be simple and clear, and focus on business identification rather than advertising. Signs should generally include the name of the business and logo, with minimal additional text.
- Signs that use icons, symbols, or logos rather than words (e.g., a shoe for a shoe store, a bicycle wheel for bike shop, etc.) are especially encouraged.
- Buildings and centers with multiple tenants should have a shared common sign that identifies the building/center name, but not list all the individual tenants.
- Signs should be designed as an integral part of the building, being consistent with its architectural style, scale, materials, and color.
- Size of signage should be appropriately scaled to the building façade.
- Electrical conduit, tubing, raceways, conductors, transformers, mounting hardware, and other equipment should be concealed.



Penthouses or screens should be setback from the primary building façade.

Rooftops and Mechanical Screening

The silhouette created by building roof lines is an important component of community character whether it is a two-story commercial building viewed from the street frontage or a high-rise mixed use building viewed from afar. Rooftops also need to accommodate servicing and life-safety requirements, that needs to be appropriately screened while still retaining a form that will be a distinctive and memorable contribution to the Uptown's skyline.

Recommendations:

- Rooflines should be sculpted and expressive in a manner that complements the composition of the building.
- Buildings with flat roofs should use strong, attractively detailed cornices or parapets to define the roofline.
- All mechanical penthouses and stair towers should be screened and architecturally integrated into the form of the building. Materials used to clad mechanical equipment and penthouses should complement the rest of the building.
- Locate rooftop equipment so that it is not visible from streets or other public spaces. Mechanical penthouses or screens should be setback at least 5 feet from the building façade.
- Rooftop design should consider potential views from surrounding taller buildings. Green roofs, and roof gardens or patios can be used to enhance rooftop appearance surrounding buildings.

Design Guidelines by Building and Typical Block Type

Uptown features a variety of building types at different scales. Scale has a great impact upon the appearance of the neighborhood and the interaction with the public realm and pedestrian experience. In an area with as much history as Uptown, retaining a sense of scale and character is crucial to the community’s vision for future development. Also, with San Diego’s mild coastal climate and setting, ensuring access to sunlight, air circulation and views of the physical environment are especially important. The following design guidelines address the scale and massing of buildings to ensure that the community vision is implemented and that Uptown realizes an appropriate mix and placement of buildings of different shapes and sizes. For purposes of these guidelines, buildings are categorized as one of three building types: low-rise, mid-rise, and high-rise. These designations are indicated in Figure 4: Heights.



Low-Rise (Up to '35)



Mid-Rise ('35 to '75)



High-Rise (Over '75)

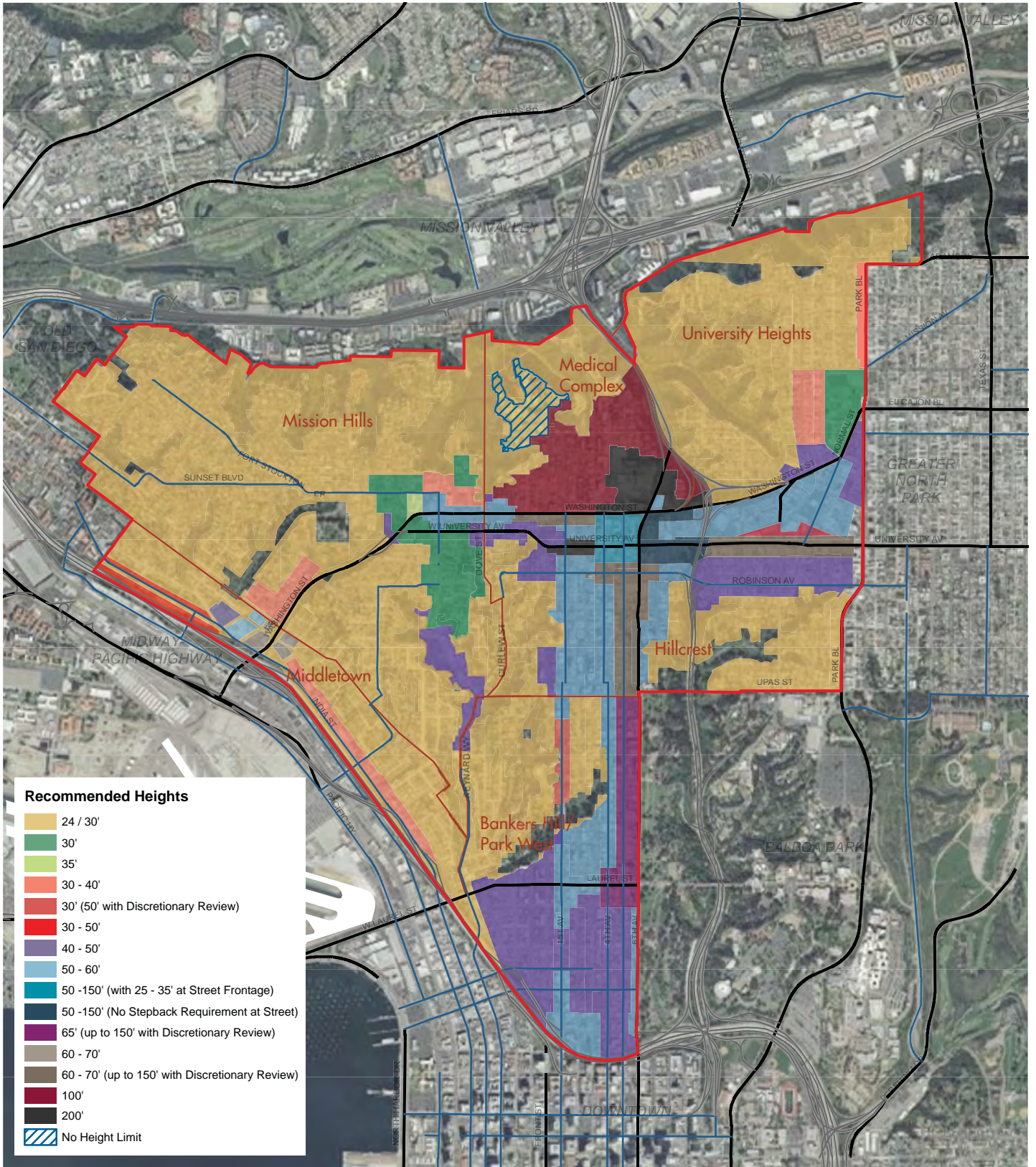
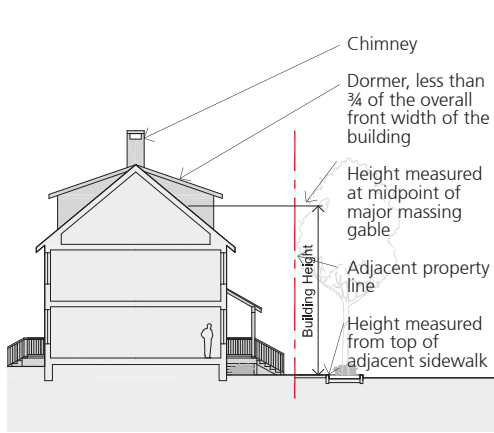

FIGURE 4: HEIGHTS

Component Glossary and Diagrams

Height Definitions



Buildings with sloped roofs

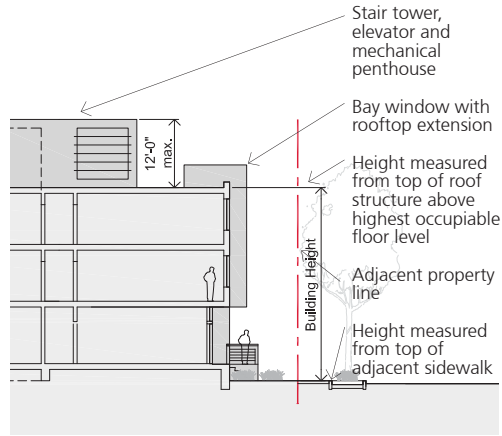

Buildings with flat roofs

Note: Measurement of height will depend on the height definitions specified in San Diego Municipal Code.

Massing & Bulk Controls

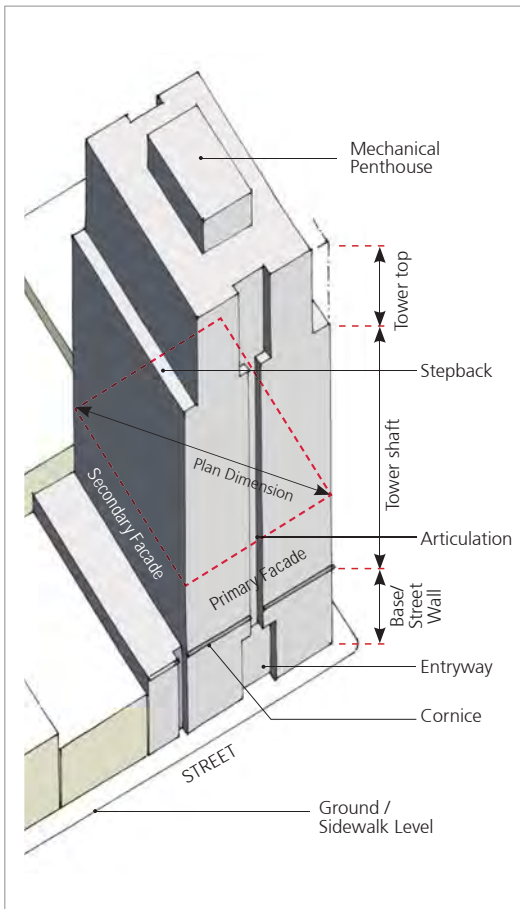

Building Articulation

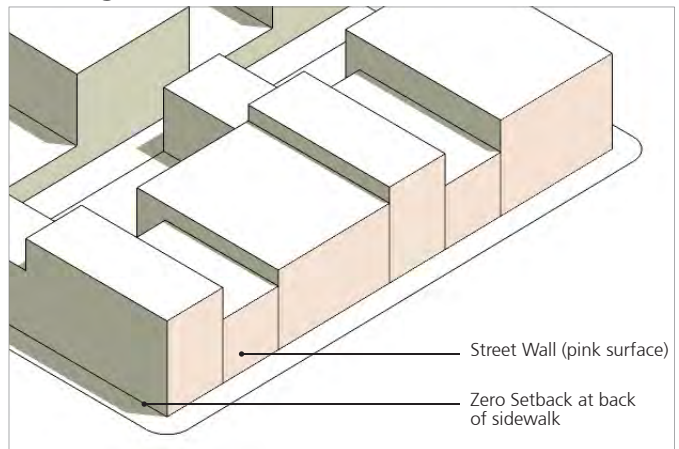

Building Types: Low-Rise: Up to 35'

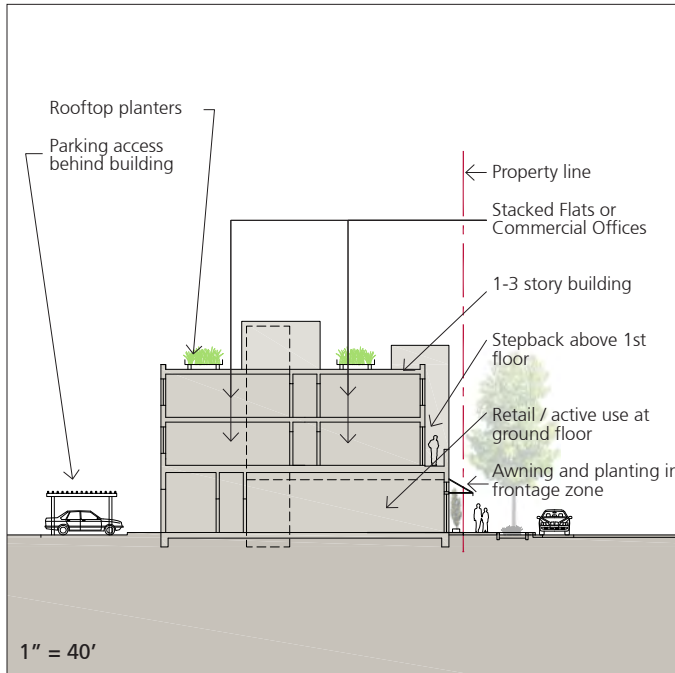

Illustration of 3 story, 35' tall building with 3' front setback

In Uptown, low-rise commercial and mixed-use buildings are defined as buildings that are 3 stories (35') or less in height. This building type includes single-use commercial and mixed-use commercial/residential buildings, and is common along Uptown's commercial corridors and commercial districts. Front and side setbacks are intended to be minimal or are set at zero. Primary pedestrian access is from the primary street frontage. Parking is typically surface or tuck-under parking located behind the building, and accessed from a rear alley, or from the side or front by a narrow side-drive. Where ground floor residential units are permitted, street level units should have direct access to the public streetfront via front porches or stoops.

Guidelines for Low-Rise Buildings	
Heights	
Height Range	1-3 stories, up to 35'
Height Transitions & Massing	Building massing should not overwhelm adjacent buildings. Buildings should be no more than 1.5 stories higher than adjacent buildings within 30' of the shared property line
Setbacks	
Front	0' to 10'; or aligned with adjacent buildings
Rear	3' along alley 5' if adjacent to another property
Side Yard	5' if adjacent to another property 0'-10' along minor street
Ground Floor Characteristics	
Use	Commercial; Residential OK on non-commercial street frontages.
Height	12' clear recommended min. for all commercial uses; 9' clear recommended min. for residential
Elevation	Commercial: at adjacent sidewalk / grade level. Residential: Recommended 2'-6" to 3'-0" above adjacent sidewalk level; 5' max. above sidewalk.
Streetwall Coverage	Building to extend at least 75% across lot width at ground floor.
Bulk & Massing	
Stepbacks	No requirements
Bulk Reduction	No requirements
Plan Dimensions	No requirements
Allowable Parking & Building Types	
Parking Location	Behind or under buildings. May be private or common. Surface parking, internal garages, podium parking, or subterranean parking. No parking access from main streets unless unavoidable.
Building Types	Commercial buildings and Mixed-Use (Commercial with Multi-family Stacked residential)

III. COMMUNITY-WIDE DESIGN GUIDELINES

PRIVATE REALM | COMMERCIAL & MIXED-USE AREAS

Mixed-Use:
Residential Over
Commercial /
Retail



Mixed-Use
Commercial /
Retail



Mixed-Use
Commercial/
Hotel over Retail



Single-Use
Commercial:
Office



Building Types: Mid-Rise: 35' to 75'

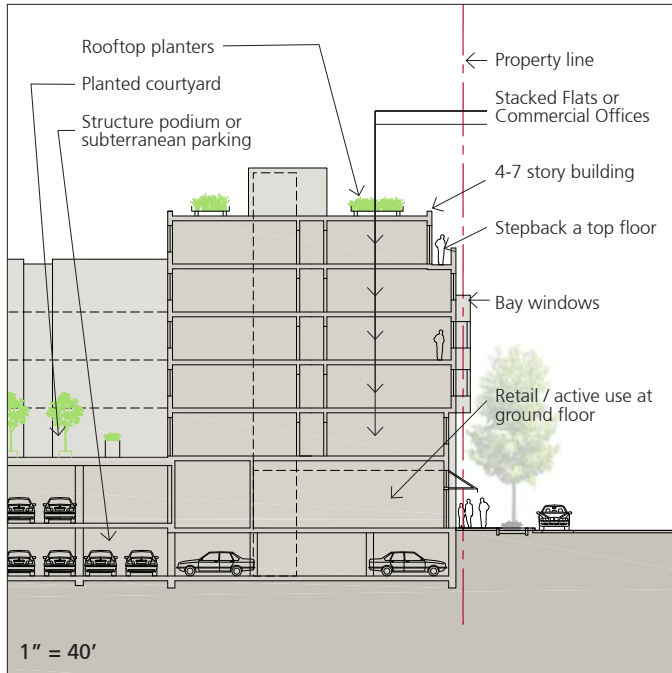

Illustration of 6 story, 65' tall building with 2' front setback

In Uptown, mid-rise commercial and mixed-use buildings are defined as buildings that are between 4 and 7 stories in height (45' - 75'). In Uptown, this building type most frequently takes the form of a mixed-use commercial/residential building with ground-floor commercial and upper story residential, although there are also examples of mid-rise commercial buildings. This type is most commonly found along some of the busier corridors, such as Park Boulevard and Fifth Avenue, near the primary commercial districts. Front and side setbacks are minimal or zero. Primary pedestrian access is from the primary public street frontage. Parking is typically integrated into the building footprint, either below grade or in a parking podium, and accessed via a rear alley or from the side or front by a narrow side-drive.

Note: The number of floors in this building type will vary with the initial use. For example, a single-use commercial office building may fit approximately 5 floors, at 14' floor-to-floor height, within the 70' maximum height. A mixed-use residential building may fit 6 floors of residential at 9'-8" floor-to-floor with a 12' commercial ground floor.

Guidelines for Mid-Rise Buildings	
Heights	
Height Range	Up to 75'. Typically 4-7 stories
Height Transitions & Massing	Building massing should not overwhelm adjacent buildings. Buildings should be no more than 1.5 stories higher than adjacent buildings within 30' of the shared property line
Setbacks	
Front	0' to 10'; or aligned with adjacent buildings
Rear	3' along alley 5' if adjacent to another property
Side Yard	5' if adjacent to another property 0'-10' along minor street
Ground Floor Characteristics	
Use	Commercial; Residential OK on non-commercial street frontages.
Height	12' clear recommended min. for all commercial uses; 9' clear recommended min. for residential
Elevation	Commercial: at adjacent sidewalk / grade level. Residential: Recommended 2'-6" to 3'-0" above adjacent sidewalk level; 5' max. above sidewalk.
Streetwall Coverage	Building to extend at least 80% across lot width at ground floor.
Bulk & Massing	
Stepbacks	Varies by location
Bulk Reduction	No requirements
Plan Dimensions	No requirements
Allowable Parking & Building Types	
Parking Location	Behind or under buildings. May be private or common. Surface parking, internal garages, podium parking, or subterranean parking. No parking access from main streets unless unavoidable.
Building Types	Commercial buildings and Mixed-Use (Commercial with Multi-family Stacked residential)

*Mixed-Use:
Residential Over
Commercial /
Retail*



*Single-Use
Commercial:
Office*



Building Types: High-Rise: Over 75'

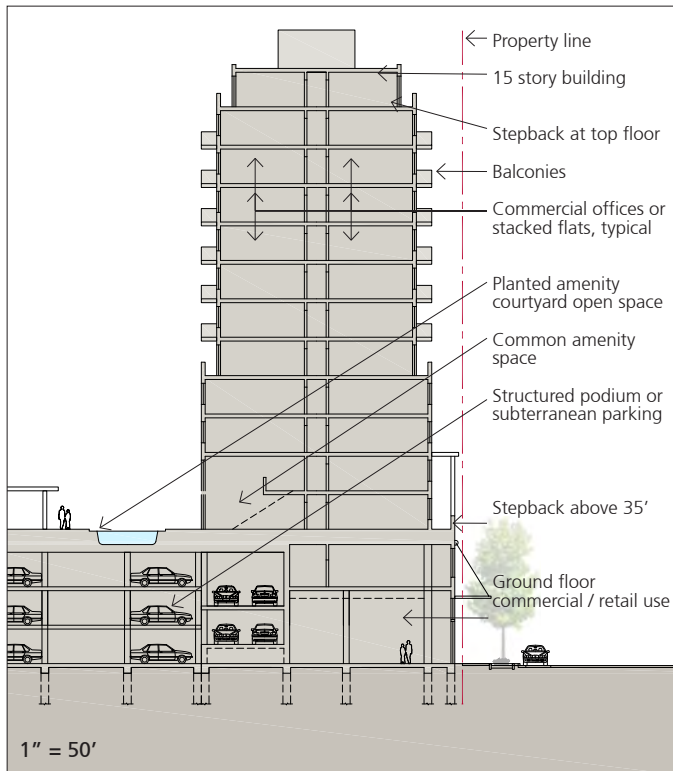

Illustration of 14 story, 155' building with 2' front setback

In Uptown, high-rise commercial and mixed-use buildings are defined as buildings that are 8 stories or greater in height (85'+). High-rise buildings in Uptown tend to be primarily residential in nature and are most often located where they can capture views of either Balboa Park or the Bay. The primary exceptions are the hospital buildings in the Medical Complex. Due to their scale, high-rise buildings often have shallow front, side and rear yard setbacks. High-rise residential developments generally occupy larger parcels, and single development can often occupy a quarter, half, or full block. A common building configuration uses a 3-6 story "base" covering the majority of the site and one or two "towers" extending up from the base. Parking is located behind or under the buildings, on the interior of the block, screened from view. Parking is typically integrated into the building footprint, either below grade or in a parking podium, and accessed via a rear alley or from the side or front via a narrow side-drive. Facade articulation is typically in the form of recessed or projecting balconies and may include terraces at upper levels where the building steps back. Bulk and massing guidelines ensure that towers of high-rise buildings are adequately spaced and are more slender at the top.

Guidelines for High-Rise Buildings	
Heights	
Height Range	Over 75' (Over 7 stories)
Height Transitions & Massing	Building massing should not overwhelm adjacent buildings. Buildings should be no more than 1.5 stories higher than adjacent buildings within 30' of the shared property line
Setbacks	
Front	0' to 15'; or aligned with adjacent buildings
Rear	3' along alley 5' if adjacent to another property
Side Yard	5' if adjacent to another property 0'-15' along minor street
Ground Floor Characteristics	
Use	Commercial; Residential OK on non-commercial street frontages.
Height	12' clear recommended min. for all commercial uses; 9' clear recommended min. for residential
Elevation	Commercial: at adjacent sidewalk / grade level. Residential: Recommended 2'-6" to 3'-0" above adjacent sidewalk level; 5' max. above sidewalk.
Streetwall Coverage	Building to extend at least 80% across lot width at ground floor.
Bulk & Massing	
Stepbacks	Varies by location
Bulk Reduction	Above 30': Residential use: Single floorplate should not exceed 13,000 sf Office use: Single floorplate should not exceed 13,000 sf Top Floor: 10% bulk reduction
Plan Dimensions	Residential use: 160' max. diagonal Office use: 175' max. diagonal
Allowable Parking & Building Types	
Parking Location	Behind or under buildings. Typically shared. Structured podium parking, or subterranean parking. No parking access from main streets unless unavoidable.
Building Types	Commercial buildings and Mixed-Use (Commercial with Multi-family Stacked residential)

III. COMMUNITY-WIDE DESIGN GUIDELINES

PRIVATE REALM | COMMERCIAL & MIXED-USE AREAS

High-Rise
Mixed
Commercial:



Design of
Towers

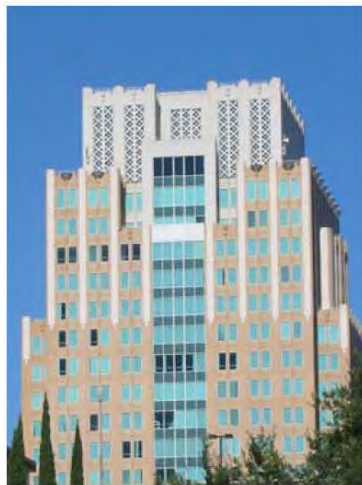

Parking

Parking is a critical factor in both the aesthetic character and the economic stability of the Uptown. In order to be successful, the Uptown needs to not only ensure that adequate parking is provided to support proposed uses, but that the location and design of that parking also supports the creation of an attractive, pedestrian-friendly mixed use district. The current prevalence of sites in the Hillcrest core, and along Washington Street and University Avenue, with front-loaded surface parking lots and driveways crossing public sidewalks is functionally and aesthetically at odds with the vision for the Uptown. The urban design guidelines are intended to reduce the visual prominence of on-site parking and the potential for pedestrian/vehicle conflicts by placing it on the interior of blocks, in structures, or below ground.

Recommendations:

- In order to accommodate permitted development intensities while maintaining an attractive pedestrian environment, surface parking is discouraged and should be kept to a minimum.
- When surface parking is used, it should be located behind buildings and on the interior of blocks where it is screened from public view.
- Generally, off-street parking should be located in above- and below-grade parking structures.
- Parking structures should be located on the interior of the block where feasible.
- Parking should not be visible as a ground-floor use. Parking garages adjacent to public streets should be wrapped with “liner” space for retail, commercial or residential uses that activate the street frontage and screen parking. At the very least, retail and other pedestrian-oriented uses should line the street-level façade of parking structures fronting on public streets.
- Upper floors of parking that are visible from the street should be designed to screen views of cars and parking structure lighting, and to reflect a level of articulation



Entrances to parking garages should be integrated into building design and isolated from primary pedestrian entrances, if possible.

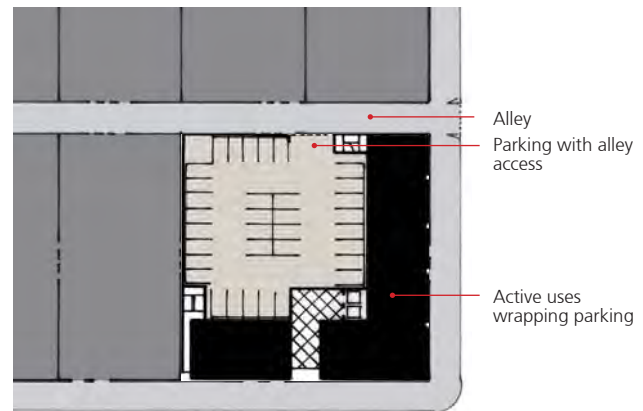

Parking not exposed to street, but wrapped with active uses

and design character consistent with the rest of the building façade.

- Access to off-street parking should be provided primarily from mid-block alleys or from block ends via shared driveways. Driveways and curb cuts generally should not occur on primary retail street frontages.
- In order to reduce pedestrian/vehicle conflicts, existing curb cuts and driveways along retail streets ultimately should be phased out as subject properties are redeveloped and alternative access can be provided.
- Landscaping and lighting should be provided in all surface parking lots. The treatment of parking areas should be part of a sustainable site design strategy, incorporating elements such as permeable pavement, recycled or native materials, and climate-appropriate plants.

Historic Resources

The Uptown has a rich history, and the buildings and landscapes that are the legacy of that history contribute significantly to the area’s character. In order to preserve Uptown’s unique identity and connection to its past, it is important to protect historic resources, even as the Uptown continues to change. Adaptive reuse is highly encouraged as a strategy to retain these resources. Adaptive reuse refers to the reusing of existing buildings, or some or all of the building’s structural elements or architectural features, while re-purposing the building for a new or updated use. Adaptive reuse also can advance sustainability objectives, by conserving materials and reducing energy needed for new construction.

A variety of tax incentives are available for historic properties if they are maintained in accordance with the Secretary of the Interior’s Standards for Rehabilitation. Income-producing properties are eligible for federal tax credits per the Historic Preservation Tax Credit. The Low-Income Housing Tax Credit may also be used in combination for adaptive reuse projects. The Mills Act property tax reduction is available for properties located within a city-designated Historic District.

Recommendations:

- The adaptive reuse of historic structures is encouraged when the building can accommodate a new development program, and it is financially feasible.
- The proposed new use for an historic building should achieve the goal of revitalization and/or conservation while being consistent with established neighborhood character.
- Reuse projects involving state, local, or federally-listed buildings must be done in accordance in the Secretary of the Interior’s Standards for Rehabilitation.
- Adaptive reuse should be done in accordance with all other guidelines and zoning requirements, while respecting the building’s integrity.



Historic commercial buildings offer flexible space for adaptive reuse for commercial and residential uses.



Historic commercial buildings in Mission Hills are ideal for new commercial uses.

Sustainable Design

Sustainable building design should be an essential element of all future development – both in response to community concerns, and as an imperative of responsible energy and resource consumption. Uptown can be a model of sustainable development that demonstrates how to build responsibly within the limits of our resources, without compromising the ability of future generations to enjoy at least the same quality of life that we have today. The sustainability strategy for the Uptown is not just about building design, but is multi-faceted. As such, sustainability objectives are reflected in the goals, policies, and guidelines of all elements of this Community Plan. The key elements of the Uptown’s sustainability strategy include:

- Protecting and enhancing Uptown’s natural habitat and its ecological function,
- Creating a multi-modal transportation system that reduces automobile dependency and associated traffic congestion and air pollution,
- Establishing a diverse and stable blend of retail, employment and service uses that supports the basic needs of the Uptown community,
- Providing a mix of housing types that accommodates a diversity of households (families, seniors, young couples, singles, etc.) and income levels, and
- Building in a manner that conserves resources.

The LEED rating system (Leadership in Energy and Environmental Design) has set standards for sustainable design in recent years, and other rating systems advance similar goals. Additionally the State of California has its own green building standards, the California Green Building Standards Code (CalGreen), which enhances existing Title 24 regulations. This law mandates sustainable building practices focused on using renewable resources, energy efficiency, indoor air quality, and sustainable site development.



Sustainable design includes site and landscape design that is appropriate for the climate and conditions of San Diego.



The use of sustainable site design elements aid in reducing stormwater runoff.

Recommendations:

- Sustainable strategies should be used in the design of all private-realm buildings and landscapes, including, but not limited to:
 - Reducing energy consumption by designing buildings that take advantage of features such as natural ventilation, natural daylighting, better insulation (e.g., green roofs), energy efficient light fixtures, and solar rather than gas water heaters;
 - Reducing total water consumption (potable and non-potable) by introducing features such as low-flow fixtures and climate-appropriate drought-tolerant landscaping;
 - Reducing stormwater runoff by implementing features that promote reuse of stormwater

- (e.g., rainwater harvesting) for non-potable uses such as irrigation and toilet flushing and groundwater infiltration (e.g., bioswales);
- Reducing the use of non-renewable energy by incorporating elements such as photovoltaic panels and the new generation of smaller, low-impact wind turbines; and
- Using recycled, rapidly renewable, and locally-sourced materials that reduce impacts related to materials extraction, processing, and transportation.

- At a minimum, all future development should meet the standards of CalGreen. More rigorous sustainable practices are encouraged.
- Use of LEED (or similar rating system) by developers is encouraged as a means of demonstrating commitment to sustainability.

Canyon Interface

Uptown’s canyons are among the community’s most treasured elements, providing natural open space features that shape the community’s identity and built form. Each of Uptown’s neighborhoods abut at least one of these important open space resources and is influenced by the views, the natural environment, and the open space they provide. In addition, the Uptown’s three canyon pedestrian bridges are landmarks within the community. Given their significance, it is important that development along the canyons not detract from the aesthetic, environmental or open space benefits that they provide.

Recommendations:

- Ensure that canyon rim and hillside development is unobtrusive and maintains the scale and character of the surrounding community.
- Developments which are on any portion of a property within designated open space should maintain existing views and public access to canyon areas.

- Buildings should be designed to limit their visual impact on views from within or across the canyon through landscape screening and by stepping building volumes down the slope (rather than perching over the canyon on piers)
- Buildings along the canyon edge generally should be designed to conform to the hillside topography by using a stepped foundation down the slope, rather than cantilevering over the canyon.
- Exposed under-floor areas, large downhill cantilevers, and/or tall support columns for overhanging areas should be avoided for both aesthetic and fire safety reasons
- Roof pitches should be designed to approximate the hillside slope.
- Canyon-facing facades should be articulated to reduce apparent mass and create interest.
- Buildings should be designed and vegetation managed to reduce potential for wildfire hazards.
- The permitted floor area for lots partially within open space areas should be based only upon that portion of the lot outside of the open space designation. As a minimum for lots predominantly or entirely within open space, the permitted floor area should assume a lot depth of 100 feet rather than the true lot depth in computing the lot area. In designing the project, the garage should not be eliminated in an effort to reduce the floor area.



Buildings that abut canyons should maintain a low profile.

Residential Areas

The following guidelines apply to all areas of Uptown that are zoned for Single-Family or Multi-family Residential Uses. The Commercial and Mixed-Use Guidelines that preceded this section apply to areas that may include residential uses, but are zoned for mixed-use or commercial uses. In general, the Uptown areas zoned primarily for residential uses are well-established and not anticipated to experience significant change. Thus, the focus of the following guidelines is on maintaining and reinforcing their current character and sensitively guiding future infill development.

PUBLIC REALM

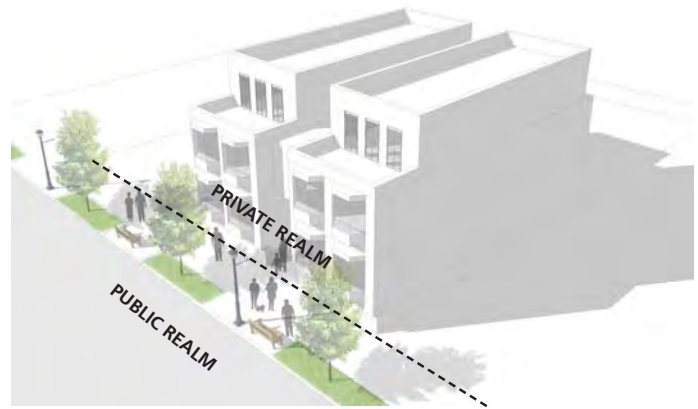

Multi-Family Residential Area

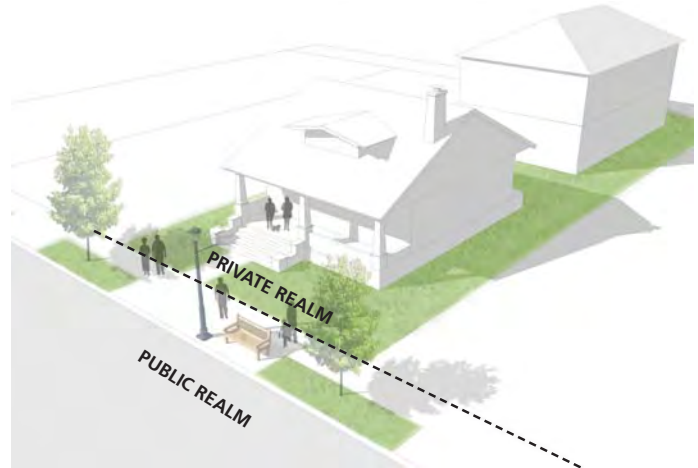

Single-Family Residential Area

Residential Streets

Residential streets in Uptown are primarily local streets intended to provide access to residences within the neighborhood, with little or no through traffic. As a result, the streets are intended to accommodate relatively low traffic volumes and slow travel speeds. They are also the setting for much of a neighborhood’s communal life—where neighbors stroll and greet each other. As such, the design of these streets plays an important role in community character by ensuring that these streets are both safe and attractive.

Uptown’s residential streets fall into two broad categories: the rectilinear grid of quite wide streets found in University Heights and Park West, and the narrower and often more curvilinear streets of Mission Hills and Middletown. Many of Uptown’s residential streets have a defined character, which should be maintained and reinforced. Other streets, particularly those with wide street cross-sections, have room for improvement in terms of both their aesthetic and functional characteristics. The following guidelines suggest strategies for making these streets safer, more attractive, and more conducive to pedestrian and bicycle activity.

Residential Streets

Although Uptown’s residential streets do not all share identical dimensions, their design is important for creating a clear and attractive residential character, and ensuring a safe environment.

Recommendations:

- On streets with curb-to-curb cross-sections in excess of 40’, consider design strategies to calm traffic, enhance pedestrian scale, and create better definition of the public realm. Such strategies include, but are not limited to:
 - On streets with curb-to-curb cross-sections in excess of 40’, consider design strategies to calm traffic, enhance pedestrian scale, and create better definition of the public realm. Such strategies include, but are not limited to:



Typical Hillcrest Residential Street



Typical Mission Hills Residential Street

- Adding bulb-outs and crosswalks at key intersections
- Necking down street cross-sections in mid-block areas to create landscaped areas
- Narrowing the street cross-section to create wider parkways (planter strips) between the street and sidewalk
- Adding diagonal parking on one side of the street
- Providing a consistent planting of street trees along both sides of the street
- Adding landscaped center medians
- Adding landscaped traffic circles at key intersections
- Adding bike lanes
- On streets with no consistent street tree planting, implement a program to select a tree species for

regular planting along the street that will enhance neighborhood identity, add visual interest, and create a more comfortable pedestrian environment.

- On streets where a predominant street tree has already been established, but is not consistently planted, implement a program to enhance streetscape character by infilling gaps with the same species.

Residential Alleys

Alleys in residential areas provide the opportunity to reduce the impact of automobiles on the public streets by reducing the number of driveway curb cuts and vehicle trips along neighborhood streets. Residential alleys are prevalent throughout much of the residential areas of Hillcrest and University Heights that have long blocks. Alleys are typically 20 feet wide, but are narrower in some of the older parts of Uptown.

Recommendations:

- New development should be required to use alleys, where they exist, for access to residential parking, and not allow street front driveways and parking in front yard setbacks.
- Residential alleys should be designed as shared-use environments where safety and aesthetics are considered:
 - Trash bins should be screened from view at all times and should not intrude into the alley right-of-way.
 - Alleys should have paving materials that are conducive for both vehicular and pedestrian activity.
 - Landscape elements should be encouraged within private property adjacent to alley right-of-way.
 - Overhead utility lines should be undergrounded to reduce visual clutter
- Rear yard setbacks of 2'-5' should be considered adjacent to alleys to accommodate turning movements and provide space for landscaping.



This Hillcrest alley allows access to individual properties and service and loading access.

- Alleys should be designed to assist in managing stormwater runoff, including necessary drainage infrastructure and/or porous paving.

Parking

Uptown streets provide on-street parking for use by both residents and visitors. On-street parking can play an important role in reducing demand for private, on-site parking that can drive up housing costs and adversely impact building and site design. The prevalence of streets with unusually wide curb-to-curb widths is an opportunity to provide more public parking, through the introduction of diagonal parking, while also calming traffic and reducing the apparent street widths. This strategy has already been effectively employed in areas of Park West, Hillcrest and University Heights. From an urban design perspective, the primary concerns are to ensure that on-street parking is aesthetically and functionally integrated into the design of the public realm.

Recommendations:

- On streets with wide (50' or greater) curb-to-curb cross-sections, the addition of diagonal on-street parking on one side of the street is encouraged as a way to increase parking capacity and calm traffic (also refer to street design guidelines above).

- Where diagonal parking is introduced, the use of reverse angle (i.e., back-in rather than more typical head-in) parking is encouraged as a way to improve vehicular and bicycle safety.
- In order to mitigate the visual impact of long, uninterrupted rows of parked cars, the introduction of landscape planting areas within the parking lane (“tree islands”) is encouraged. The introduction of street trees into these parking lane planters will also help to reduce the apparent width of the street.
- Where diagonal parking is introduced, landscaped curb extensions should be included at each end of the block to integrate the parking into the streetscape (i.e., visually terminate the ends of the diagonal parking lane) and shorten pedestrian crossing distances.



Reverse-diagonal parking is encouraged to improve safety on residential streets.



Residential streets in Uptown usually include on-street parking in the public right-of-way for visitors and additional spaces for private property.

Streetscape Improvements, Landscape, and Furnishings

Residential streets generally do not have the same degree of pedestrian activity or need the level streetscape furnishings as streets in commercial and mixed-use areas. The primary design concern is with creating a safe, comfortable, and attractive pedestrian environment that accommodates the needs of local residents.

Recommendations:

General:

- Every street should have continuous, well-maintained sidewalks on both sides of the street.
- Sidewalks should be paved with grey concrete or should match the tone and material of adjacent properties and that of the overall neighborhood character.
- Ideally, a planting strip should be located between the curb and sidewalk to provide a buffer between pedestrians and the street edge.
- Street furnishings should be located adjacent to the sidewalk, so they do not interfere with pedestrian circulation.



Sidewalks in residential areas should be maintained consistent with the level of pedestrian activity and with a material consistent with adjacent blocks.

- All overhead utilities should be undergrounded to eliminate visual clutter and conflicts with street trees.
- Unique neighborhood identity monuments or other features that contribute to neighborhood character should be located in the planting strip.

Landscaping:

- Creating a consistent planting of street trees along residential streets is strongly encouraged. Street trees should be selected to:
 - Contribute to neighborhood identity
 - Mitigate the scale of wide streets
 - Provide shade for the pedestrian environment
 - Add visual interest (color, texture, pattern, etc.)
 - Planting strips should always be landscaped, and not permitted to be paved.

Street Lighting:

- The introduction of street lighting should be considered as a way to promote pedestrian activity, enhance public safety and contribute to neighborhood identity.
- Street light design should reflect the character of the street and the neighborhood and create a visual hierarchy relative to the scale of the street. A single consistent style and size of fixture should be used along a given street.
- Light fixtures generally should be low in height (e.g., 12' to 16') to establish a pedestrian-scaled environment and to minimize light spill into adjoining properties.
- Use of cut-off type fixtures that focus light down toward the ground and shield areas not intended to be illuminated is encouraged.
- Levels of illumination should be responsive to the type and level of anticipated activity, without over illuminating the area. (i.e., bright, uniform lighting of all public right-of-ways is not desirable). Lower levels of illumination are generally appropriate for residential neighborhoods.



A consistent width of planting strips should be maintained within the public right-of-way.



Street tree location should not interfere with pedestrian movement and be determined through a consistent planting plan and concept design.

- Color-balanced lights that do not cast a tinted light are preferred.

Transit Stops:

- All transit stops should be prominently signed and all pertinent route and schedule information, including major connecting services, should be posted.
- To the extent feasible, transit stops should be equipped with transit shelters that provide seating and protection from the elements.
- Transit shelters should be designed to be and consistent in scale and character to the surrounding residential area.

Signs:

- In order to avoid visual clutter, the use of signs in residential areas generally should be limited, and when used should be understated and modest in scale.
- Signs (i.e., plaques) to identify key historic, cultural, or civic landmarks that contribute to neighborhood identity are encouraged.
- Directional and informational signs should be attractive, clear, and consistent in theme, location, and design.

Seating:

- Benches and other forms of seating (e.g. low walls, planter edges) should be provided in plazas, parks, transit stops and other locations where community gathering is encourage

Public Spaces

- Given the limited amount of usable open space within the developed residential areas, the community should explore creative ways to create small public open spaces by repurposing underutilized utility easements, extra-wide street rights-of-way, and undevelopable remnant parcels to create usable open space. Strategies might include:
 - Expanding the size of bulb-outs (curb extensions) at key intersections and mid-block neck-down areas to create small plazas/pocket parks
 - Using remnant and/or vacant parcels, even if only on an interim basis, as sites for community gardens
 - Narrowing a street cross-section to create a wide, linear greenway along one side of the street.
- Efforts should be made to increase the functionality of publicly-owned open space in Uptown’s canyons by:
 - Enhancing existing access points to the canyons to make them clearly visible and welcoming
 - Creating new access points to the canyons from the neighborhoods
 - Improving and expanding trail facilities to enhance connectivity within the canyons and to adjacent residential areas



Residential developments may enhance the public realm through street lights and permeable spaces within blocks.



Public open spaces may provide areas for community agriculture.

Sustainable Infrastructure

Sustainable design is encouraged throughout Uptown, including the public realm in residential areas. In the public realm, sustainability guidelines apply to landscape and streetscape infrastructure systems.

Recommendations:

- Reuse and recycling of construction and demolition materials is recommended for all new public realm construction.
- Use of materials from renewable sources is highly encouraged.
- Regional and drought-resistant plant species should be used for landscaping to reduce water consumption..
- The use of planting strips designed to treat and attenuate stormwater flow is encouraged whenever feasible as a means of reducing stormwater runoff rates and volumes. The City’s Stormwater Standards manual should be referenced for further guidance.
- The use of porous paving in parking lanes should be considered as a strategy for reducing stormwater runoff rates and volumes.
- In order to conserve energy and reduce long-term costs, energy-efficient strategies should be explored for street lights, including:
 - Use of LED or Energy Star-certified lamps for all public realm lighting
 - Monitoring and limiting hours of illumination in public realm lighting to avoid waste
- Street tree planting and other public realm landscaping is encouraged as a strategy for:
 - Reducing the build-up of surface temperatures in paving and buildings (i.e., the “urban heat island effect”) and resulting need for air conditioning by shading heat absorptive surfaces

- Reducing stormwater runoff and improving water quality through the combination of foliage cover, pervious surfaces, and evapotranspiration
- improving air quality by removing carbon dioxide (CO2), other gaseous pollutants, and particulate matter from the atmosphere



Climate appropriate species should be used in private realm landscaping.



Planting strips adjacent to residences, though in the public realm, may be landscaped and maintained by private property owners.

PRIVATE REALM

The private realm is the term used to describe the portion of the built environment that is occupied by building and associate improvements and is generally in private ownership. Within the Uptown’s residential areas, the private realm is occupied predominantly with single-family residential homes, and a smaller amount of multi-family residential development. Given the age of Uptown’s neighborhoods and the overall quality of the residential inventory, the primary design concern in the Uptown’s residential areas is protection of community character in the face of the inevitable change that occurs as communities age.

As in the private realm in commercial and mixed use areas, the guidelines for the private realm in residential areas are based on the following objectives:

- **Context:** Allow for creative architectural solutions that acknowledge contextual design through emulation, interpretation, or contrast in character.
- **Character:** Complement the architectural character of existing historic buildings and promote harmony in the visual relationships and transitions between new and older buildings.
- **Scale:** Relate the bulk of new buildings to the prevailing scale of development to avoid an overwhelming or dominating appearance in new construction.
- **Pedestrian:** Encourage building design that helps activate and define the public realm and enhance the pedestrian experience.
- **Materials:** Promote the use of high quality building materials, detailing and landscaping.
- **Integrated Services:** Promote functional and aesthetic integration of building services, vehicular access and parking facilities.
- **Sustainable Design:** Promote sustainability in building design, construction and operation.

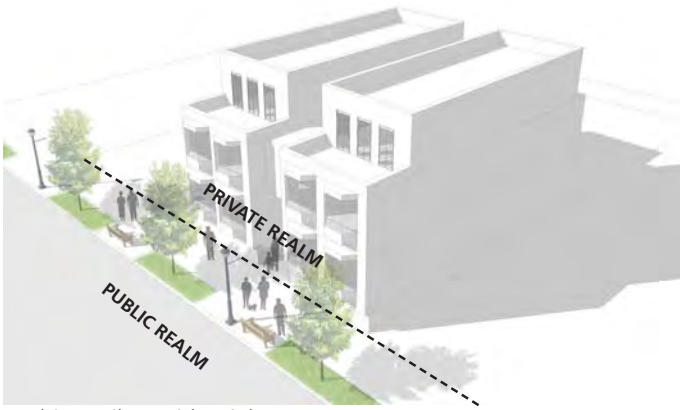

Multi-Family Residential Area

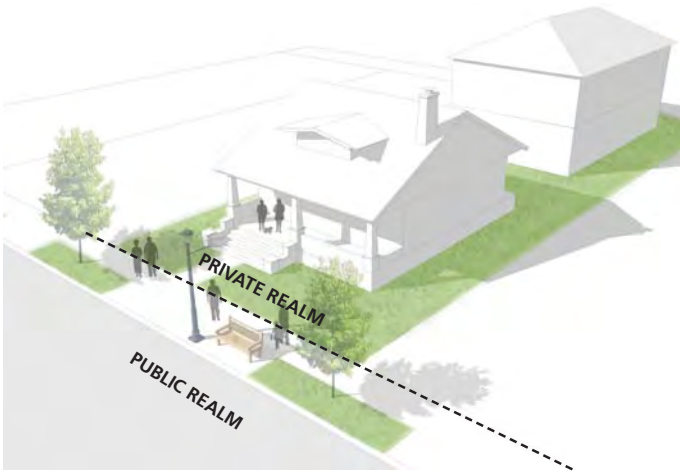

Single-Family Residential Area

Site Planning

The residential areas in Uptown are diverse in character, with parcel and home sizes varying by area, but within each neighborhood there is usually a predominant development pattern that has been established. Since most future development in these neighborhoods will be infill, it is important that it be consistent with established patterns in order to preserve neighborhood character. This begins with site planning, and defining the relationship that buildings have with the public realm and with adjoining residences.

The distance buildings are setback from the street and what is allowed to occur in the front setback are key features that define the character of the public realm. In order to create a coherent character, it is important to maintain the consistent alignment of building frontages that characterizes most residential neighborhoods.

Recommendations:

- Building setbacks from the street should be consistent with the predominant setback established on the block, or the adjacent two properties, whichever is more consistent.
- In order to create more interesting facades, variations in the building frontage (e.g., recessed entries, stoops, etc.) are allowed, but in all cases at least 60% of the façade should be aligned with predominant setback established along street.
- Buildings should be oriented parallel to existing streets to frame and positively define the public realm.
- Residential buildings, whether single-family or multi-family, should have their primary entrance fronting onto the primary street.
- In multi-family projects, ground-floor units generally should front onto and take direct access from the street, rather than having shared a shared entry and access from interior corridors.

- In no instance should surface parking be allowed to be located between the building frontage and the public street right-of-way.



New construction should be in scale with typical Uptown residential development.



Entrances to residential units should be oriented to address the street, but simultaneously provide privacy through delineation of private areas.

Design Guidelines by Building Type

Although Uptown’s residential areas are comprised of predominantly low-rise development, the planning area also includes a variety of mid- and high-rise buildings. Scale has a great impact upon the appearance of the neighborhood and the interaction with the public realm and pedestrian experience. In Uptown’s historic residential neighborhoods maintaining consistent scale and character is crucial to maintaining community character. The following design guidelines address the scale and massing of buildings to ensure that the community vision is implemented and that Uptown realizes an appropriate mix and placement of buildings of different shapes and sizes. For purposes of these guidelines, buildings are categorized as one of three building types: low-rise, mid-rise, and high-rise. These designations are indicated in Figure 4: Heights.

Low-Rise

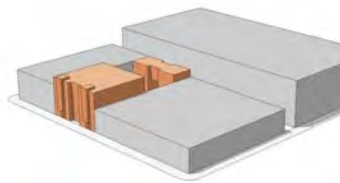

Mid-Rise

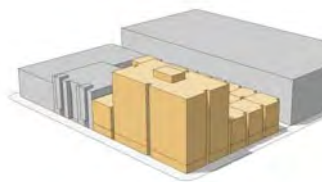

High-Rise

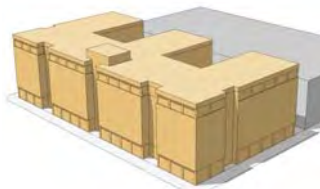
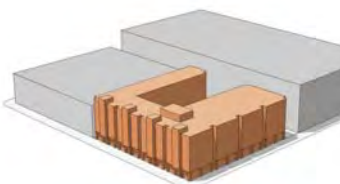
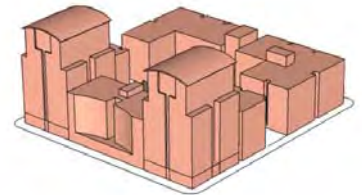

Building Types: Low-Rise: Up to 35'

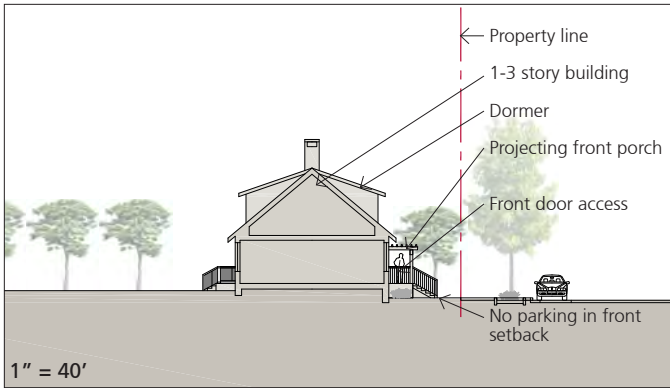

Illustration of 1 1/2 story, 25' tall building with 15' front setback

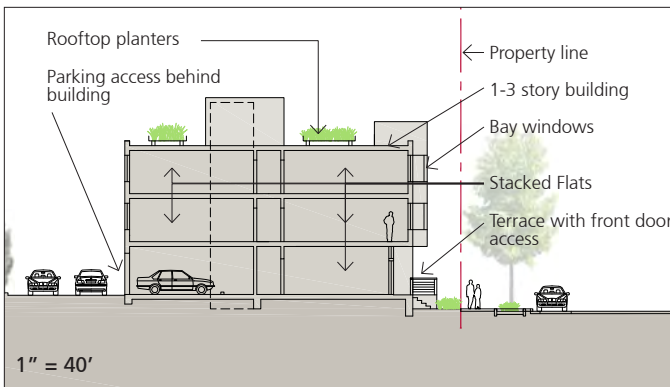

Illustration of 3 story, 34' tall building with 10' front setback

Low-rise residential buildings include buildings ranging from 1 to 3 stories. This type includes detached units (single-family houses), attached units (duplexes, townhouses), and stacked units (stacked flat apartment buildings). One- and two-story single-family houses are by far the most prevalent in the Uptown. -Low-rise residential buildings generally have more generous front, side and rear yard setbacks. Primary pedestrian access is from the primary public street frontage. Even in multi-family buildings, ground-floor units should have direct access to the public street frontage via street-facing front porches or stoops. Parking access generally depends on the block structure. On blocks with alleys, parking should be accessed from the rear of the lot. Whereas, on blocks with no alleys, parking access is typically provided via driveways from the primary street frontage. Parking for low-rise buildings is typically within enclosed garages in single-family residences, and either surface or tuck-under parking in multi-family projects.

Guidelines for Low-Rise Buildings	
Heights	
Height Range	1-3 stories, up to 35'
Height Transitions & Massing	Building massing should not overwhelm adjacent buildings. Buildings should be no more than 1.5 stories higher than adjacent buildings within 30' of the shared property line
Setbacks	
Front	10' to 20'; or aligned with adjacent buildings
Rear	3' along alley 5' if adjacent to another property
Side Yard	5' if adjacent to another property 5'-15' along minor street
Ground Floor Characteristics	
Use	Residential only. Common support uses also allowed in multi-family buildings.
Height	9' clear recommended min.
Elevation	Residential: Recommended 2'-6" to 3'-0" above adjacent sidewalk level; 5' max. above sidewalk. Lobby and other common uses: at adjacent sidewalk level
Streetwall Coverage	Building to extend at least 50% across lot width at ground floor.
Bulk & Massing	
Stepbacks	No requirements
Bulk Reduction	No requirements
Plan Dimensions	No requirements
Allowable Parking & Building Types	
Parking Location	Behind or under buildings. May be private or common. Surface parking, internal garages, podium parking, or subterranean parking. No parking access from main streets unless unavoidable.
Building Types	Single Family, Duplex, Attached, Multi-family stacked units (flats, lofts, townhouses, etc.)

III. COMMUNITY-WIDE DESIGN GUIDELINES

PRIVATE REALM | RESIDENTIAL AREAS

Detached Units



Attached Units



Stacked Units



Building Types: Mid-Rise: 35' to 75'

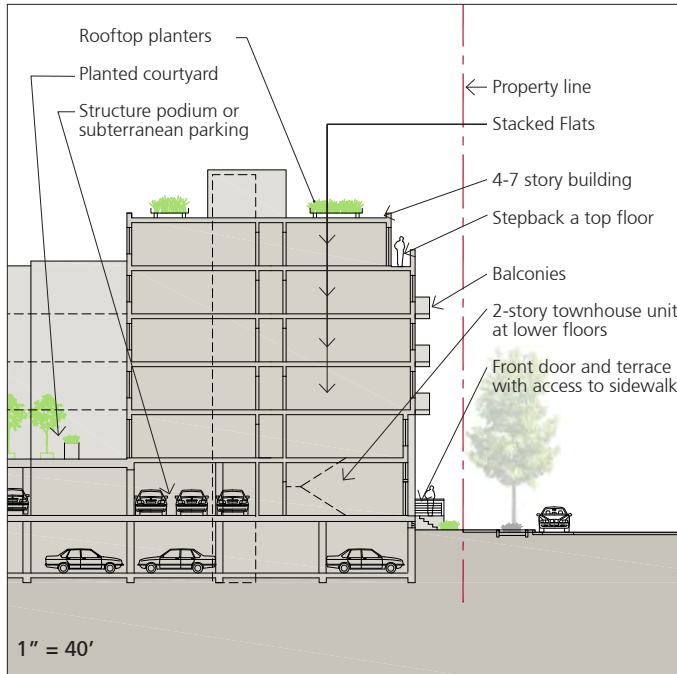

Illustration of 6 story, 65' tall building with 2' front setback.

Mid-rise residential building types includes buildings ranging from 4 to 7 stories. This building type includes stacked units in a variety of layout configurations, like flats, lofts, and 2-story townhouse units. This type is most commonly found along some of the busier corridors, such as Park Boulevard and Fifth and Sixth Avenues. Mid-rise buildings usually have shallow front, side and rear yard setbacks. Primary pedestrian access is from the primary public street frontage. Parking is typically integrated into the building footprint, either below grade or in a parking podium, and accessed via a rear alley or from the side or front by a narrow side-drive.

Guidelines for Mid-Rise Buildings	
Heights	
Height Range	Up to 75'. Typically 4-7 stories
Height Transitions & Massing	Building massing should not overwhelm adjacent buildings. Buildings should be no more than 1.5 stories higher than adjacent buildings within 30' of the shared property line
Setbacks	
Front	0' to 15'; or aligned with adjacent buildings
Rear	3' along alley 5' if adjacent to another property
Side Yard	5' if adjacent to another property 0'-15' along minor street
Ground Floor Characteristics	
Use	Residential only. Common support uses also allowed in multi-family buildings.
Height	9' clear recommended min.
Elevation	Residential: Recommended 2'-6" to 3'-0" above adjacent sidewalk level; 5' max. above sidewalk. Lobby and other common uses: at adjacent sidewalk level
Streetwall Coverage	Building to extend at least 50% across lot width at ground floor.
Bulk & Massing	
Stepbacks	Varies by location
Bulk Reduction	No requirements
Plan Dimensions	No requirements
Allowable Parking & Building Types	
Parking Location	Behind or under buildings. May be private or common. Surface parking, internal garages, podium parking, or subterranean parking. No parking access from main streets unless unavoidable.
Building Types	Multi-family with stacked units (flats, lofts, townhouses, etc.)

III. COMMUNITY-WIDE DESIGN GUIDELINES

PRIVATE REALM | RESIDENTIAL AREAS

*Mid-Rise
Residential*



Building Types: High-Rise: Over 75'

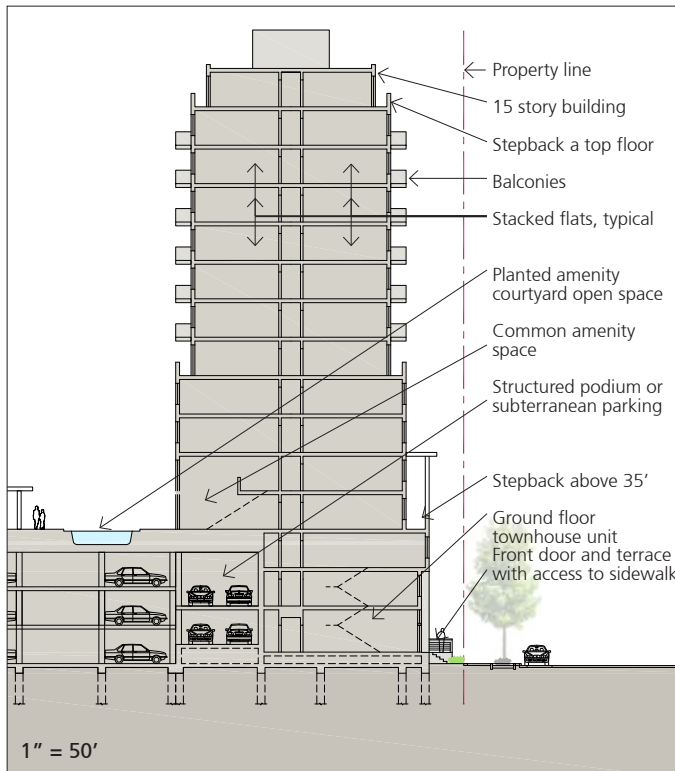
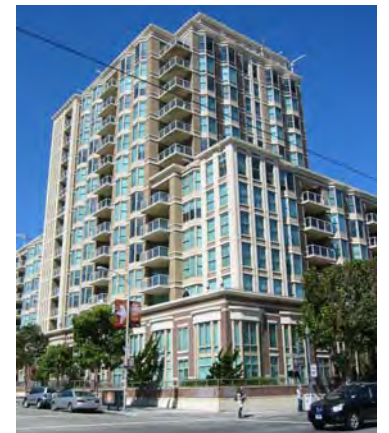

Illustration of 15 story, 155' building with 10' front setback

In Uptown, high-rise residential buildings are defined as buildings that are 8 stories or greater in height (85'+). High-rise residential buildings in Uptown tend to be located where they can capture views of either Balboa Park or the Bay. Due to their scale, high-rise buildings often have shallow front, side and rear yard setbacks. High-rise residential developments generally occupy larger parcels, and a single development can often occupy a quarter, half, or full block. A common building configuration uses a 3-6 story “base” covering the majority of the site and one or two “towers” extending up from the base. Parking is typically integrated into the building footprint, either below grade or in a parking podium, and accessed via a rear alley or from the side or front via a narrow side-drive. Facade articulation is typically in the form of recessed or projecting balconies and may include terraces at upper levels where the building steps back.

Guidelines for High-Rise Buildings	
Heights	
Height Range	Over 75'. Over 8 stories
Height Transitions & Massing	Building massing should not overwhelm adjacent buildings. Buildings should be no more than 1.5 stories higher than adjacent buildings within 30' of the shared property line
Setbacks	
Front	0' to 15'; or aligned with adjacent buildings
Rear	3' along alley 5' if adjacent to another property
Side Yard	5' if adjacent to another property 0'-15' along minor street
Ground Floor Characteristics	
Use	Residential only. Common support uses also allowed in multi-family buildings.
Height	9' clear recommended min.
Elevation	Residential: Recommended 2'-6" to 3'-0" above adjacent sidewalk level; 5' max. above sidewalk. Lobby and other common uses: at adjacent sidewalk level
Streetwall Coverage	Building to extend at least 80% across lot width at ground floor
Bulk & Massing	
Stepbacks	Varies by location
Bulk Reduction	Above 30': Residential use: Single floorplate should not exceed 13,000 sf Office use: Single floorplate should not exceed 13,000 sf Top Floor: 10% bulk reduction
Plan Dimensions	Residential use: 160' max. diagonal Office use: 175' max. diagonal
Allowable Parking & Building Types	
Parking Location	Behind or under buildings. May be private or common. Structured podium parking, or subterranean parking. No parking access from main streets unless unavoidable.
Building Types	Multi-family Stacked Units (stacked flats, stacked lofts, stacked townhouses, flats over townhouses, etc.)

High-Rise Residential with Ground-Floor Units



Frontage conditions for ground floor residential units



Building Scale, Massing & Configuration

The scale, massing, and detailing of buildings has a substantial impact upon neighborhood character. Nearly all of residential development in Uptown's residential areas is less than three stories (35') in height, and the vast majority is one or two stories. However, even within this small range of building heights the massing and configuration of new buildings is crucial to producing high-quality, memorable architecture that is compatible with established development patterns.

Building Massing, Height Transitions and Façade Articulation

For a number of reasons, past infill development often has not fit well into established residential neighborhoods, particularly as it relates to scale, massing, and building heights. For example, contemporary homeowner's find Uptown's older houses too small to meet their needs, which results in building additions that are out of scale and character with their neighbors. Also, the combination of high housing demand and high land values results in new multi-unit developments that are often out of scale with their settings.

Recommendations:

- Building massing and façade articulation should contribute to a fine-grained, pedestrian scale environment at the street level.
- New and modified buildings should conform to the predominant scale of the district and be sensitive to the scale of adjacent uses.
- A combination of building setbacks, upper-story stepbacks, and articulated sub-volumes should be employed to sensitively transition to adjacent lower height buildings (to the side or rear).
- Upper-story additions should be setback from the primary façade to preserve the historic scale of the building at the front setback.
- The massing of buildings on combined lots should be

designed to respond the pattern and rhythm of adjacent single-parcel development.

- Buildings should generally be designed with simple, harmonious proportions that reflect the district's historic buildings
- Features, such as porches and stoops, deep entry and window openings, balconies, window bays, eaves and rooflines should be used to add variety and interest, and mitigate apparent massing.
- Excessive roof breaks and overly complicated roof forms should be avoided.
- Building articulation should address climatological considerations to access the ideal amount of sunlight and air.



New residential projects may be designed to mimic the form and massing of regional historic precedents through fenestration, volumes, and recesses.



Entrances to residential units should be elevated above the street level.

Fenestration

Windows should be used as an element which helps to articulate the character of a façade, and designed to reveal and the thickness/ depth of the façade wall. Windows should be well-proportioned and operable where appropriate.

Recommendations:

- Design and location of windows should have character, style, and scale appropriate to the overall building design.
- Windows should be grouped to establish rhythms across the façade and hierarchies at important places on the façade.
- Windows should be included along all walls visible from the public realm. Blank walls should be avoided.
- Windows should not be flush with the exterior wall surface. Window glass should be recessed a minimum of three (3) inches from the exterior wall surface to add relief to the wall surface. Wainscoting and reveals can also be used to enhance the appearance of deep-set windows.
- Generally, all occupied rooms should have operable windows to allow for natural ventilation.

Architectural Character and Detailing

As new homes are added to existing Uptown neighborhoods it is important that they fit into the neighborhood by complementing the best examples of existing residential development on the block. New development that is compatible with existing homes will contribute to the sense of place and enhance neighborhood character. Given the strong design character of many of Uptown's residential neighborhoods, it is assumed that Conservation areas will be established to protect and enhance Uptown's most distinctive residential neighborhoods, and that additional guidelines will be prepared that are specific to the design character of these neighborhoods.



Design and location of windows should have character, style, and scale appropriate to the overall building design.



New development that is compatible with existing homes will contribute to the sense of place and enhance neighborhood character.

Recommendations:

- The architectural design of new housing should complement the architectural styles of existing homes on the block. If there is a mixture of styles on a block, then the design of new housing may be more flexibly interpreted but should still be responsive to the shared characteristics of existing housing (e.g., setbacks, heights, massing, etc.).
- New stylistic interpretations of traditional architecture are encouraged. The plans should follow fundamental design principles without copying them.
- Architectural features and detailing should be proportional to the scale of the home, as well as to other homes on the block of a similar architectural style.

- Additions should be designed with architectural details that are consistent with those of the existing structure.
- Individual elements in a structure should be consistent with that structure’s overall design or style.
- All elevations should be given equal design treatment and architectural consideration.
- Use of stylistically cohesive, character-defining features, such as porches, columns, balustrades, brackets, rafters, and decorative trim, enhances visual compatibility.
- The roof pitch, overhang depth, and gable orientation on new residential buildings should be similar to those of existing homes on the block.
- The roof forms and slopes of additions to existing buildings should be similar to those of the original structure. Generally, the roof of the addition should be subordinate to that of the primary building.
- The scale and style of porch and entry elements should be consistent with the scale and style of the residence, and should respect the scale and style of similar elements on the other residences on the block.

Materials

The use of materials is essential for creating the type of quality buildings and built environment that define Uptown. This includes the materials that are featured in the area’s historic buildings such as stucco, brick and masonry. Accent materials used in entryways, windows, and cornices must also be of the highest quality to ensure durability and character.

Recommendations:

- High-quality, durable materials should be used in all projects. Stone, terra cotta, brick and wood are examples of quality materials.
- New developments should respond in a compatible manner to the existing color, texture and materials used on surrounding significant buildings.
- Materials and colors should be related to masses and volumes.
- Sustainable, local and rapidly-renewable materials should be incorporated to the extent feasible and if compatible with overall design strategy.



Roofs, overhangs, and gables of new residential buildings should be similar to those of existing block character.

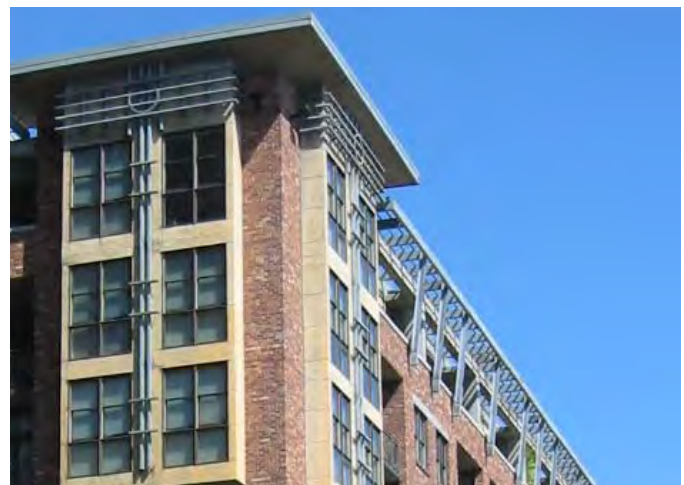

High-quality, durable materials should be used in all projects.

Lighting

The primary purpose of illuminating residential buildings is to provide for security and pedestrian safety. Thus, residential buildings generally maintain relatively low levels of exterior illumination, with lighting focused on key entries and access paths. Façade lighting is typically used to enhance details of the front facade, while landscape lighting is used to illuminate plant materials and pathways.

Recommendations:

- Lighting strategies should enhance building and site design features.
- To enhance the security of the home, illumination should be focused on the front entryway, walkways, and garage area. Recessed entryways should be clearly illuminated.
- Building addresses should be illuminated and clearly visible from the street at night.
- Exterior lighting should be angled downwards or include cut-off shields that provide for efficient illumination without trespass to adjoining properties.
- Fixture design should complement the architecture, and be integrated into the whole of the building design.
- Electric sources should be concealed and not conflict with architectural detailing.



Façade lighting is typically used to enhance details of the front facade and should complement overall architectural design theme.

Signage

Residential signage is only appropriate for use in multi-family projects where it is needed to identify a project or clarify wayfinding.

Recommendations:

- Signs identifying the name of a development and its address should be easily visible from the street to assist visitors and emergency vehicles, and should be illuminated to be visible after dark.
- Entry signage shall be provided at all primary access points to the complex and within the complex, as needed, to provide clear direction to visitors.
- Signs should be constructed of high-quality material.
- Sign message on residential buildings should be limited to the name of the complex and the address.
- Signs should be envisioned as part of the overall design vision of a project. They should incorporate similar design vocabulary, colors, and materials.



Residential signage should be simple and discreet and not overpower building design.

Parking

Parking is an unfortunate requirement of all new development that impacts community character and drives up development costs. From an urban design perspective, the less visible that parking is the better. Generally, parking should be integrated into the building and site design in a manner that does not detract from the character of the building or the public streetscape.

Recommendations:

- Whenever possible, parking should be located behind buildings away from public view.
- No parking should be located between the public street and the adjacent residential façade.
- For infill projects on blocks where alleys are present, parking and garages should be accessed from the alley.
- Driveways and curb-cuts should be minimized along the primary street frontage to the extent feasible.



Private parking garages with front-accessed driveways should be tucked behind primary building.

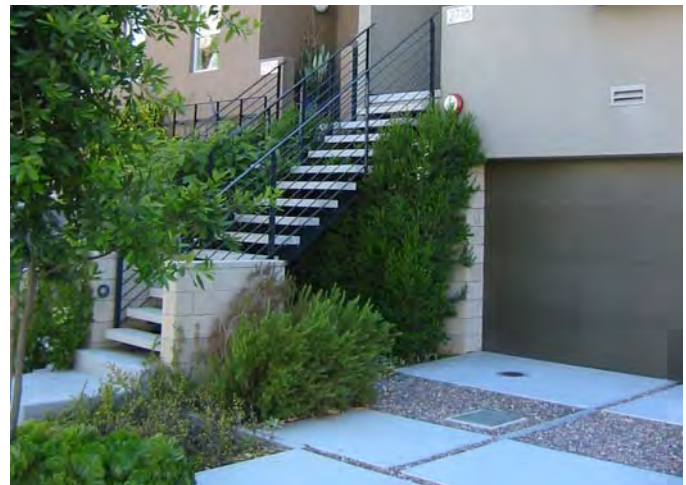

Front-loaded garages on townhomes should be attractively designed and landscaped to create an attractive building frontage.

Recommended vehicular access and garage types

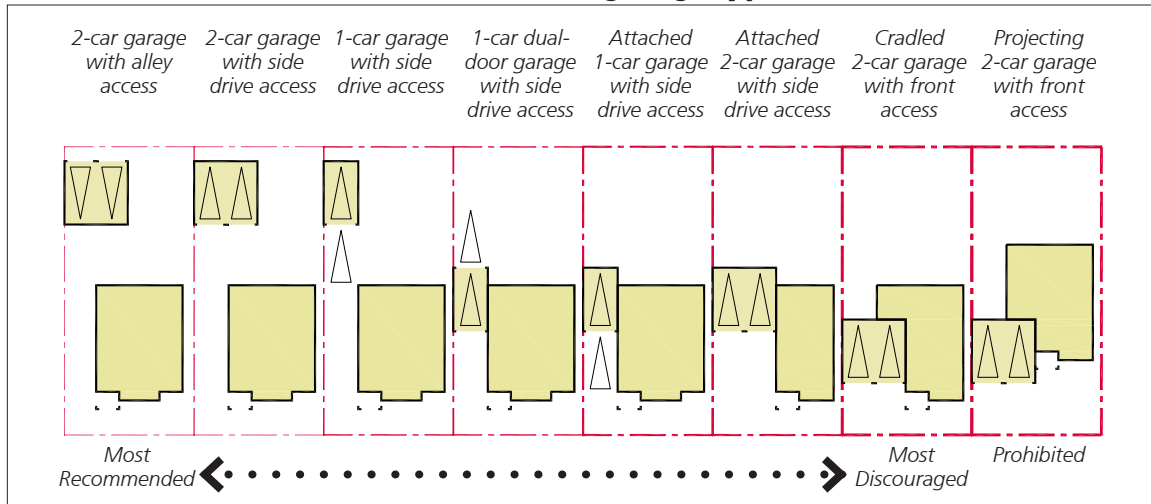

Historic Resources

Uptown’s residential areas are rich with historic resources. Stately homes dating from the late nineteenth century to the early to mid-Twentieth century are distributed throughout its neighborhoods, illustrative of the early periods of San Diego’s development. Many of these structures are listed on national, state, and local registers of historic resources, which provides a layer of protection. Equally important to the preservation of key historical works is the preservation of overall neighborhood character as represented by a prevailing style or appearance. This is expected to be accomplished through the establishment of Historic Districts where clusters of historic structures exist. Several potential historic districts have been identified for formal designation. Although not specifically targeted at historic resources, Conservation Areas are another mechanism being explored to protect areas with distinctive neighborhood character. Both historic districts and conservation areas will have additional design guidelines prepared that are tailored to the specific design characteristics of their particular neighborhoods to further protect and enhance distinctive character areas.

In residential areas, adaptive reuse may be employed for changing private residences into small offices or business spaces. However, this option is more likely in the Commercial and Mixed-Use Areas.

A variety of tax incentives are available for historic properties if they are maintained in accordance with the Secretary of the Interior’s Standards for Rehabilitation. Income-producing properties are eligible for federal tax credits per the Historic Preservation Tax Credit. The Low-Income Housing Tax Credit may also be used in combination for adaptive reuse projects. The Mills Act property tax reduction is available for properties located within a city-designated Historic District.

Recommendations:

- Historic resources should be maintained and celebrated whenever possible.
- Additions or modifications to all historic structures should be done in a manner that complements the architectural style. Reuse projects involving state, local, or federally-listed buildings must be done in accordance in the *Secretary of the Interior’s Standards for Rehabilitation*.
- Adaptive reuse should be done in accordance with all other guidelines and zoning requirements, while respecting the building’s integrity.
- The proposed new use for an historic building should achieve the goal of revitalization and/or conservation while being consistent with established neighborhood character.
- Reuse projects involving state, local, or federally-listed buildings must be done in accordance in the Secretary of the Interior’s Standards for Rehabilitation.
- Adaptive reuse should be done in accordance with all other guidelines and zoning requirements, while respecting the buildings’ integrity.



The preservation of historic resources includes the preservation of individual buildings in addition to the retention of neighborhood character.

Sustainable Design

Sustainable building design should be an essential element of all future development – both in response to community concerns, and as an imperative of responsible energy and resource consumption. Uptown can be a model of sustainable development that demonstrates how to build responsibly within the limits of our resources, without compromising the ability of future generations to enjoy at least the same quality of life that we have today. The sustainability strategy for the Uptown is not just about building design, but is multi-faceted. As such, sustainability objectives are reflected in the goals, policies, and guidelines of all elements of this Community Plan. The key elements of the Uptown's sustainability strategy include:

- Protecting and enhancing Uptown's natural habitat and its ecological function,
- Creating a multi-modal transportation system that reduces automobile dependency and associated traffic congestion and air pollution,
- Establishing a diverse and stable blend of retail, employment and service uses that supports the basic needs of the Uptown community,
- Providing a mix of housing types that accommodates a diversity of households (families, seniors, young couples, singles, etc.) and income levels, and
- Building in a manner that conserves resources.

The LEED rating systems (Leadership in Energy and Environmental Design) has set standards for sustainable design in recent years, and other rating systems advance similar goals. Additionally the State of California has its own green building standards: Title 24 (now called CalGreen) which mandates sustainable building practices focused on using renewable resources, energy efficiency, indoor air quality, and sustainable site development.

Recommendations:

- Sustainable strategies should be used in the design of all private-realm buildings and landscapes, including, but not limited to:
 - Reducing energy consumption by designing buildings that take advantage of features such as natural ventilation, natural daylighting, better insulation (e.g., green roofs), energy efficient light fixtures, and solar rather than gas water heaters;
 - Reducing total water consumption (potable and non-potable) by introducing features such as low-flow fixtures and climate-appropriate drought-tolerant landscaping;
 - Reducing stormwater runoff by implementing features that promote reuse of stormwater (e.g., rainwater harvesting) for non-potable uses such as irrigation and toilet flushing and groundwater infiltration (e.g., bioswales);
 - Reducing the use of non-renewable energy by incorporating elements such as photovoltaic panels and the new generation of smaller, low-impact wind turbines; and
 - Using recycled, rapidly renewable, and locally-sourced materials that reduce impacts related to materials extraction, processing, and transportation.



The use of local, renewable materials, and building interior and exterior spaces that have access to ample light and air are associated with sustainable building design.

- At a minimum, all future development should meet the standards of CalGreen. More rigorous sustainable practices are encouraged.
- Use of LEED (or similar rating system) by developers is encouraged as a means of demonstrating commitment to sustainability.
- Sustainable landscape treatments should be used in all private landscaping. This includes drought-tolerant and climate-appropriate planting materials, and light-colored paving materials.

Canyon Interface

Uptown’s canyons are among the community’s most treasured elements, providing natural open space features that shape the community’s identity and built form. Each of Uptown’s neighborhoods abut at least one of these important open space resources and is influenced by the views, the natural environment, and the open space they provide. In addition, the Uptown’s three canyon pedestrian bridges are landmarks within the community. Given their significance, it is important that development along the canyons not detract from the aesthetic, environmental or open space benefits that they provide.

Recommendations:

- Ensure that canyon rim and hillside development is unobtrusive and maintains the scale and character of the surrounding community.
- Developments which are on any portion of a property within designated open space should maintain existing views and public access to canyon areas.
- Buildings should be designed to limit their visual impact on views from within or across the canyon through landscape screening and by stepping building volumes

down the slope (rather than perching over the canyon on piers)

- Buildings along the canyon edge generally should be designed to conform to the hillside topography by using a stepped foundation down the slope, rather than cantilevering over the canyon.
- Exposed under-floor areas, large downhill cantilevers, and/or tall support columns for overhanging areas should be avoided for both aesthetic and fire safety reasons
- Roof pitches should be designed to approximate the hillside slope.
- Canyon-facing facades should be articulated to reduce apparent mass and create interest.
- Buildings should be designed and vegetation managed to reduce potential for wildfire hazards.
- The permitted floor area for lots partially within open space areas should be based only upon that portion of the lot outside of the open space designation. As a minimum for lots predominantly or entirely within open space, the permitted floor area should assume a lot depth of 100 feet rather than the true lot depth in computing the lot area. In designing the project, the garage should not be eliminated in an effort to reduce the floor area.



Structural supports for buildings along the canyon interface should be minimal in profile.

This page to be left blank.