

# **Pedestrian Design**





## PEDESTRIAN DESIGN

The 1979 *Progress Guide and General Plan* states that walking within an urban community should be a pleasant and enjoyable experience, an opportunity for healthful exercise and quiet relaxation on the way to work, shopping, or other destinations. Instead, the pedestrian must often contend with annoying vehicular noise and fumes from the adjacent street, narrow and irregular sidewalk surfaces, and a veritable obstacle course of poles, fire hydrants, and trash containers within the public walkway. Additionally, adequate street lighting for nighttime safety is often lacking, especially at bus stops. Moreover, amenities such as shade trees, landscaping, and comfortable seating areas are infrequently provided in commercial districts where walking is the normal transportation mode<sup>1</sup>.

The City of Villages strategy calls for a convenient, efficient, and attractive multimodal transportation system in which pedestrians, bicycles, and transit vehicles are accommodated in addition to automobiles. This system should improve mobility for San Diegans by providing competitive—even preferred—alternatives to the automobile for many trips in the region. The strategy, as a policy, recommends: *Promote pedestrian- and transit-friendly design of City streets*<sup>2</sup>.

NOTE: This section of the Street Design Manual is derived from *Planning and Designing for Pedestrians, Model Guidelines for the San Diego Region*, June 2002, prepared for the San Diego Association of Governments by Community Design and Architecture. The Pedestrian Design Guideline section complements and supports the other sections of the Street Design Manual.

1. *Progress Guide and General Plan, 1979.*
2. City of Villages Strategic Framework Element, Draft January 2002.

### Who are Pedestrians?

“Pedestrian” is used throughout these guidelines to include people who walk, sit, stand in public spaces, or use a wheelchair, be they children, teens, adults, elderly, people with disabilities, workers, residents, shoppers or people-watchers. Pedestrian-oriented design is accessible design for all people.

The principal issue in the design of a pedestrian-supportive street is how to allocate its space; i.e.: How much space is required to satisfy the needs of pedestrians; how much to create active public space for deliveries; and, how much to provide for parking, bicycles, and vehicular movement?

The following discusses the pedestrian experience at street level, including street design, intersection design, sight distance, pedestrian-crossings, pedestrian refuge islands, sidewalks for overpasses and underpasses and highway on/off ramps, and pedestrian realm.

### 1. Understanding ADA & Designing for Various Disabilities and Ages

The following discussion focuses on the accessibility needs and requirements as defined by both federal and state (California Title 24) accessibility standards.

Millions of persons in the United States have some sort of permanent or temporary disability caused by injury, age, or illness. The Americans with Disabilities Act (ADA) was signed into law on July 26, 1990. This civil rights law assures that a disabled person will have full access to all public facilities—primarily to public transit, public buildings and facilities, and along public rights-of-way. Generally, this involves removing barriers to wheelchairs and installing accessible wheelchair ramps.

It is essential, however, the design of pedestrian facilities take into account the abilities and disabilities of ALL pedestrians. Mobility impairment is but one classification of disability, along with sensory deficits (the sight and hearing impaired) and cognitive impairments—those with diminished ability to process information, including language barriers.

## A. Grades

1. There should be enough sidewalk cross slope for adequate drainage. The maximum cross slope should be no more than 2 percent for compliance.
2. Along walkways, pedestrian ways, and shared pedestrian/bikeway facilities, long, steep grades should have level areas every 400 feet for the pedestrian to stop and rest. In areas where it is impossible to avoid steep grades, an alternative route should be provided.

## B. Sidewalks

1. Minimum unobstructed sidewalk width shall be 5 feet. (Exceptions may be made to a minimum of 3 feet because of right-of-way (ROW) restrictions, natural barriers, or other existing conditions. The minimum width should be expanded when there is either a vertical barrier fronting the sidewalk or a vehicle travel lane.
2. If a sidewalk is less than 5 feet wide, there shall be a 5 feet x 10 feet passing space every 200 feet of length along the sidewalk.

## C. Curb Ramps at Intersections

1. At new intersections, curb ramp should align in the direction of crosswalks, with two per corner at each intersection.
2. Curb ramps shall be installed in accordance with the San Diego Regional Standard drawings.
3. Curb ramps or full cut-throughs 48 inches in width minimum, should be provided at channelization and pedestrian refuge islands.
4. Storm drainage inlets should be placed on the uphill side of the curb ramps to prevent standing water at corner.

## D. Surfaces

1. All surfaces should be stable, firm, and slip-resistant with a minimum static coefficient of friction of 0.5.
2. Surface treatments that include irregular surfaces, such as cobblestone, can be difficult to navigate and should be avoided within the primary walkway area. Low profile textured surfaces are acceptable.

## E. Eliminating Barriers for Disabled

Since 1971, the state of California has mandated within Health and Safety Codes, section 19956.5, that sidewalks and walks shall be made accessible to and usable by persons with disabilities.

In addition to the following guidelines, individual sections of the guidelines include discussions and guidelines pertaining to ADA accessibility issues.

## 2. Street Design

At a site and detail design level, the design of streets must consider the mobility and safety of the pedestrian ensuring that maximizing traffic capacity and speeds are not the dominant consideration in street design, particularly in pedestrian-oriented areas.

### A. Issues to Consider

#### General

- A prevailing condition in much of the San Diego region is the location of buildings set back from the street, which can result in a built environment that encourages traffic to travel at higher speeds.
- While it can be important to buffer residential neighborhoods from adjacent busy and noisy streets, the need to buffer should be balanced with the need for pedestrians to easily get from the neighborhood to transit or uses along busy streets.
- Excessively wide lanes encourage higher speeds on streets that can then divide a community.
- Frequent curb cuts along a street both impede traffic flow and create more conflict points between autos and pedestrians, thus reducing the effectiveness of sidewalks as a pedestrian realm.
- Throughout the San Diego region, there are canyons and mesas that make pedestrian connections difficult to achieve.
- The warm and mild climate in San Diego throughout most of the year creates opportunities to make pedestrian travel a realistic option for many people.

### B. ADA Accessibility

- Pedestrian facilities must comply with ADA standards and California Title 24, and take into account the entire range of disabilities.
- ADA accessibility requirements most often help to create a better pedestrian environment, particularly for seniors, as well as for those with disabilities.

### C. New Development vs. Retrofit

- The guidelines and standards describe the minimum desirable improvements in most cases; and, in many cases, discussions of trade-offs between different needs are discussed to help the reader identify the compromises that may be necessary in the retrofitting of existing streets and developments.
- Improvements to accessibility should consider both sides of the street.
- Neighborhoods evolve over time and the public right-of-way configuration has an influence as to what type of development occurs.
- Prior to improvements to an existing street, utilities such as lighting, electrical and storm drains should be identified and either incorporated into the design or relocated.

**D. Relation to Transit**

- All streets that are directly served by transit should also be designed or retrofitted to serve pedestrians since there must be adequate facilities to access transit.
- Streets, sites, and buildings within an area that is walkable to transit stops should be designed or retrofitted to serve pedestrians.

**E. Guidelines**

1. Parallel routes serving all forms of traffic should be considered when resulting curb-to-curb width may not accommodate all other forms of traffic (i.e., a dedicated bicycle or transit lane, a parking lane, or a travel lane).
2. The number of pedestrian crossings should be maximized in order to prevent a street from becoming a barrier in the community.
3. More frequent intersections along arterial roads (even if they only provide right-in and right-out access for cars), coupled with an overall interconnected system of roads within the grid of arterial streets should be built in new development. This will allow better transit coverage and pedestrian access as well as improved overall circulation and community aesthetics.
4. Access Control Plans should be developed for new and existing streets that consolidate access points to adjacent properties, either through local access lanes, shared easements, or establishment of access via less-busy cross streets.
5. For retrofitting or improving existing rights-of-way, sidewalks should be constructed. Where the existing right-of-way is too narrow to accommodate sidewalk construction, additional right-of-way or public walkway easement should be acquired or the existing roadway narrowed but maintained in accordance with established minimum roadway standards.

### 3. Intersection Design and Operations

The word “intersection” means more than just the meeting of two (or more) streets. It is the where the auto realm and the pedestrian realm converge, sometimes in conflict. It is because of this that intersections are often the most vital areas along a street notwithstanding that they are the point of most conflicts between vehicles, pedestrians, and bicycles.

Intersections must be designed with pedestrian safety and accessibility in mind. If pedestrians are either prohibited from crossing or discouraged from crossing, walking as a mode of travel is hampered. The spacing of intersections or crossing points is also an important element in the creation of a supportive pedestrian environment.

This section describes how intersections can be made more pedestrian friendly by reducing crossing distances and improving visibility for both the pedestrian and the driver. Detailed discussion of specific crossing designs and elements is included in the following Pedestrian Crossings section.

#### A. Issues to Consider

##### General

- Pedestrians should be made as visible as possible since multiple conflict points for vehicles and pedestrians exist at intersections.
- Intersections that limit the crossing distance, crossing time, and exposure to traffic tend to be more acceptable to pedestrian travel.
- Drivers traveling at a slower rate of speed have more time to process and react to pedestrian conflicts at intersections.

#### B. ADA Accessibility

- Pedestrian facilities, including curb ramps, signal equipment, etc., must comply with ADA standards and California Title 24, and take into account the entire range of disabilities.

#### C. New Development vs. Retrofit

- Prior to improvements to an existing intersection, utilities such as lighting, electrical, and storm drains should be identified and either incorporated into the design or relocated.
- New intersections provide the opportunity to clarify new forms of traffic control that may provide a more pedestrian-friendly setting.

#### D. Relation to Transit

- The location and design of transit stops at intersections should consider the access needs of adjacent land uses that generate pedestrian demand for transit as well as pedestrian and traffic safety issues at the intersection.

#### 4. Sight Distance

More often than not, sight distance is discussed only from the standpoint of the driver and not the pedestrian. This is of particular concern at crosswalk locations where parked cars, utility poles, street furnishing or landscape can obstruct the line of sight for pedestrians.

##### A. Issues to Consider

###### General

- The sightlines of traffic approaching an intersection on a significant grade are compromised.
- Streets that support pedestrian movements allow for the placement of elements such as trees and medians with landscaping. The presence of such elements creates a slower speed environment that is more conducive to pedestrians. These elements shall be placed in such a fashion that adequate sight distance is provided for all users of the public ROW.
- Sightlines for vehicles at an intersection are affected both by buildings, street trees, street furniture, etc., and by the location of the stop line relative to the intersection.

##### B. ADA Accessibility

At all pedestrian crossing locations, persons in wheelchairs and small children shall be visible to the driver with on-street parking present.

###### Relation to Current Standards and Practices

- AASHTO Green Book recommends a 90-degree angle of roadways whenever possible.
- The CalTrans Highway Design Manual defines stopping sight distance requirements based on the approaching speed of vehicles (Section 201.3). These standards range from 125 feet for speeds of 20 mph to 360 feet for speeds of 45 mph.

##### C. Guidelines

1. Parking restrictions near crosswalks should be considered to remove potential obstructions to the pedestrian's line of sight, particularly that of young children and those in wheelchairs.
2. When street furnishings or other objects that obstruct view cannot be relocated, curb extension or other treatments should be considered.

#### 5. Pedestrian Crossings

One of the most effective means of turning an important corridor into a community "spine" or "seam" rather than a "divider" is providing for safe street crossings. Guidelines for installation of marked crosswalks at uncontrolled intersections and mid-block crossings are contained in Council Policy 200-07 Comprehensive Pedestrian Crossing Policy.



## A. Issues to Consider

### General

- The width of the street, the geometry of the intersection, the timing of signalization, and the frequency of crossing opportunities all play important roles in achieving a pedestrian-friendly environment.
- Closing a crosswalk does not mean that pedestrians will not continue to try to cross a street in that location.
- Crossing opportunities should be provided at regular and convenient intervals.
- Marked crosswalks are useful in channelizing pedestrian crossing activity at specified locations.
- Marked crosswalks identify appropriate crossing locations for pedestrians and alert drivers to the possible presence of pedestrians.
- The use of marked crosswalks is generally considered appropriate at signalized intersections where pedestrian activity occurs.
- Street width and traffic speed can be mitigated with the use of sidewalk pop-outs.
- Some pedestrians may become overconfident or be less aware of vehicles when crossing in a marked crosswalk. Therefore, marked crosswalks should not be used indiscriminately.

## B. ADA Accessibility

- Appropriate ADA ramps should be provided at all pedestrian crossings and median refuge areas.

## C. New Development vs. Retrofit

- Pedestrian refuge islands and pop-outs can be effective retrofit improvements that serve pedestrians who are unable to cross during one signal interval or in situations where there are no pedestrian signals and the road is excessively wide.
- Textured paving or speed tables are effective means of retrofitting streets to encourage reduced speeds in a pedestrian oriented area.

## D. Relation to Current Standards and Practices

- Details on innovative pedestrian crossing treatments for both signalized and unsignalized intersections have been published in a document by the Institute of Transportation Engineers, *Alternative Treatments for At-Grade Pedestrian Crossings, 2001*. This source described a number of measures, including those incorporating signing, striping, lighting, vertical displacement treatments, horizontal displacement, narrow lanes, curb extensions, alternative surface treatments, backdrops, overhead devices, in-pavement devices, signal equipment, pedestrian detection, etc. The study included the following conclusions:

- There are a number of geometric design features, such as curb extensions and pedestrian refuge islands, that can be used to improve safety of marked crosswalks, especially those on high-volume, multi-lane facilities.
- Areas of high pedestrian activity benefit most from being designed in ways that promote pedestrian activity and afford pedestrians a reasonable measure of comfort and safety when crossing streets.
- Lower speed streets, such as those found in active mixed-use areas and residential neighborhoods, allow the use of less complex treatments such as signs and markings.

#### E. Relation to Transit

- All transit stops require that pedestrians be able to cross the street safely and within proximity to the stop.

#### F. Guidelines

1. The width of crosswalks should be a minimum of 10 feet (3.0) wide. Unless small-scale intersection conditions dictate otherwise, widths should be increased where there is greater pedestrian activity.
2. Adequate lighting at the levels specified in the chapter on street lighting should be present.
3. Marked crosswalks should be considered for uncontrolled crossing locations if there are no controlled crossings (by a traffic signal or stop sign) within 600 feet of the proposed crossing location (provided that the other guidelines presented here are met).

4. Marked crosswalks should be provided at all signalized intersections where pedestrian crossing equipment is provided.
5. Marked crosswalks alone are insufficient (i.e., without traffic-calming treatments, traffic signals, pedestrian signals when warranted, or other substantial crossing improvements presented in these guidelines) and should not be used under the following conditions:
  - (a) Where the speed limit exceeds 40 mph.
  - (b) On a roadway with four or more lanes without a raised median or crossing island that has (or will soon have) an ADT of 12,000 vehicles per day or greater.
  - (c) On a roadway with four or more lanes with a raised median or crossing island that has (or will soon have) an ADT of 15,000 vehicles per day or greater.

6. Special crosswalk markings should be used in order to increase the visibility of the crosswalk and on uncontrolled approaches to unsignalized intersections. These special markings are generally more appropriate on roads where the adjacent land use may divert drivers' attention.

7. Curb ramps (two per corner preferred) should be provided at all crosswalks. If a raised central median extends into the crosswalk, an ADA-compliant channel must be provided through the median. A detectable warning surface should be installed within the channel.

#### G. Residential Street Crossings

##### Issues to Consider

- Enhanced pedestrian crossings in residential neighborhoods are a key component of pedestrian-oriented street design and lead to both improved pedestrian safety and the "livability" of the neighborhood.

- Residential street crossings are often combined with traffic calming measures that are designed to maintain low vehicle speeds, such as raised crosswalks, chicanes, and gateway narrowings. Refer to the Traffic Calming section of the manual.
- Enhanced pedestrian crossings in residential neighborhoods may not be used if traffic volumes are low enough that pedestrians are comfortable crossing at any location.

## Guidelines

1. Marked crosswalks in residential areas should be warranted if traffic volumes exceed 2,000 vehicles per day.
2. Enhanced pedestrian crossing measures should be considered in residential neighborhoods where a demonstrated crossing demand exists.
3. On residential streets that experience excessive vehicle speeds, enhanced pedestrian crossings should be combined with traffic calming measures such as pop-outs.

## H. Mid-block Crosswalks

### Issues to Consider

- Mid-block crosswalks provide convenient crossing locations for pedestrians when other crossing opportunities are distant or where there is a presence of concentrated mid-block pedestrian crossing demand.
- As may be the case for crosswalks at intersections, mid-block crosswalks help to concentrate pedestrian crossing activity and alert drivers to the possible presence of pedestrians.

- Safety concerns arise at mid-block crosswalks as drivers typically do not anticipate pedestrians or crosswalks at non-intersection locations.

## Guidelines

1. Mid-block crosswalks shall be installed in accordance with Council Policy 200-07.
2. Mid-block crosswalks shall be well illuminated (refer to Street Lighting section).
3. An ADA-compliant curb ramp should be provided at each end of the crosswalk.
4. Curb extensions may be considered at the crosswalk to enhance pedestrian crossing visibility and reduce crossing distance.
5. High contrast detectable surface should be installed on the sidewalk at each end of mid-block crosswalk (see Appendix IV).
6. If mid-block crosswalks are signalized, audible devices should be installed.
7. On streets that experience excessive vehicle speeds, enhanced pedestrian crossings should be combined with traffic calming measures, such as raised crosswalks or curb extensions.

## 6. Pedestrian Refuge Islands

Pedestrian refuges in wide or busy streets improve safety for pedestrians and vehicles. They are defined as areas within an intersection or between lanes of traffic where pedestrians may safely walk until vehicular traffic clears, allowing them to cross a street. Another benefit to pedestrians is that it can significantly reduce delay in crossing unsignalized intersections since the pedestrian need only search for vehicles in one direction at a time.

### A. Issues to Consider

#### General

- Pedestrian refuge islands work well on wider streets where there are long pedestrian crossing times and exposure to vehicular traffic or on streets with speeds higher than 35 mph.

### B. ADA Accessibility

- Particularly useful for slower pedestrians, such as the very young, elderly, or those with mobility disabilities.
- Where it is not possible to include ramps and waiting pads that meet ADA requirements, waiting areas should be at-grade with the roadway (channels), although slopes should facilitate drainage and planting or bollards should buffer pedestrians from moving traffic.

### C. New Development vs. Retrofit

- Pedestrian islands may be installed at intersections or mid-block locations deemed appropriate through engineering studies.

- Pedestrian islands should be considered from the outset of design for intersections that are either complex, irregular in shape, excessively wide or in areas where children and older people are expected to cross frequently

### D. Relation to Transit

- The use of pedestrian islands should be considered where transit is “running” within the street right-of-way, particularly in station areas.

### E. Guidelines

1. Refuge islands should be a minimum of four feet wide by eight feet long.
2. Pedestrian refuge islands should be well illuminated.

## 7. Sidewalks for Overpasses, Underpasses, and Highway On/Off Ramps

Access on an overpass across a highway is often along a narrow sidewalk where the pedestrian is against a wall or guardrail and is highly exposed and vulnerable to speeding traffic. The unappealing environment of underpasses is often exacerbated by poor lighting and obscured sightlines. Pedestrian access across on- and off-ramps can also be difficult since the driver is preoccupied with making the transition between the highway and the street network.

The overpass discussion is applicable to all bridges with pedestrian access and the overpass and underpass discussions are applicable to grade-separated railroad crossings.

## A. Overpasses and Underpasses

### Issues to Consider

#### General

- Overpasses and underpasses necessitate accessible ramps that require a considerable amount of additional land for installation.

### New Development vs. Retrofit

- Opportunities to widen sidewalks when retrofits occur.

### Guidelines

1. Minimum widths for walkways on over and underpasses should follow the guidelines for sidewalk width.
2. Underpasses should have a daytime illuminance minimum of 10 footcandles achievable through artificial and/or natural light provided through an open gap to sky between the two sets of highway lanes and a nighttime level of 4 footcandles.
3. Consider acoustics measures within underpasses to reduce noise impacts to pedestrians and bicyclists.

## B. Highway On/Off Ramps

### Issues to Consider

#### General

- Pedestrian safety measures should be considered where drivers are in the process of “transitioning” from high-speed highways to local streets.

### New Development vs. Retrofit

- Many existing highway access points have been designed with limited provision for pedestrian access along the local streets and the resulting situations often leave little space for retrofit.
- New highway access improvements such as reducing the turning radii need to be considered to address pedestrian and bicycle safety and access issues.

### Guidelines

1. Free-flowing entrance and exit ramps shall not be constructed in areas where pedestrians are expected.
2. A right angle intersection should be provided where the ramp meets the cross street to improve visibility for both the motorists and pedestrians as well as to reduce the crossing distance.

## 8. Creating a Pedestrian Realm

Safe and direct sidewalk connections are of key importance to creating a pedestrian-friendly environment. Sidewalks should support activities that will occur in the area and provide a comfortable place for pedestrians to take part in various activities. However, creating a high-quality pedestrian realm that supports and encourages walking takes much more than simply providing sidewalks.

The design of the sidewalk and the elements within it and the location and design of buildings are just some of the additional considerations of creating a pedestrian-supportive environment. Furthermore, walking provides more opportunities to observe details than any other

form of transport. Landscape and architectural details are necessary, therefore, to sustain interest for the pedestrians as well as to provide a safe and comfortable experience.

### A. Sidewalk Design

Sidewalks are not merely thoroughfares for pedestrians. They are also important social spaces where people interact and walk together, catch a bus, window shop, or have a cup of coffee at a café. The sidewalk must be wide enough to accommodate movement in addition to amenities such as seating that facilitate social interaction. This makes the sidewalk more comfortable and appealing, which can encourage uses that increase security.

### B. Issues to Consider

#### General

- Existing excessive right-of-way widths also allow for widening sidewalks and on-street parking, both of which significantly improve the pedestrian experience.
- Increased buffering between fast-moving traffic and abutting properties created by wider sidewalks or local access lanes makes the street more attractive for buildings to front directly onto the street.
- Provide appropriate sidewalk widths given the use and amount of activity that is expected.
- Select materials with consideration for maintenance and long-term appearance.
- Minimize obstructions and conflict points.

### C. New Development vs. Retrofit

- Dimensions of an existing sidewalk can be increased either through the acquisition of additional right-of-way, zoning a setback requirement for new development to create additional pedestrian space, or through a reduction in curb-to-curb roadway width where applicable. Another alternative to reducing roadway width in these cases could be to revise the parking from parallel to diagonal, which would slow speeds and create opportunities for improved pedestrian environment.
- New streets must balance the needs of all users in determining right-of-way width.

### D. Relation to Transit

- The “footprint” of and access to transit facilities such as bus shelters must be considered in the design of sidewalks.
- Sidewalks must connect transit facilities with the adjacent uses within walking distance of the station or bus stop.
- Review MTDB publication, “Designing for Transit,” as well as these guidelines in relation to pedestrian access to transit facilities.

### E. Establishing “Zones”

The Sidewalk Corridor is typically located within the street right-of-way between the curb and building face and/or property line. The sidewalk corridor is composed of four distinct zones: the Edge Zone, the Furnishing Zone, the Throughway Zone, and the Frontage Zone.

## 1. Edge Zone

The Edge Zone (sometimes referred to as the “Curb Zone”) is the interface between the roadway and the sidewalk. At a minimum, this zone includes the 6”-wide curb. In more active, mixed-use areas with on-street parking, this zone should be a minimum of 1’6” to accommodate the door swing of a parked car to prevent conflict with elements within the Furnishing Zone. At transit stops with shelters, this zone should be widened to four feet to provide wheelchair access to the shelter. (In constrained conditions, transit shelters are available with partially open sides, allowing the Edge Zone to be reduced to 2’6”). Providing a pop-out for the entire length of the transit stop is also an effective way to increase Edge Zone width.

## 2. Furnishings Zone

The Furnishing Zone also accommodates street trees and landscaping. It is the zone that provides the buffer between the active pedestrian walking area, the Throughway Zone, and street traffic. Street trees, tree lawns, street furniture, utility poles, phone booths, parking meters, fire hydrants, bicycle racks, and the like are consolidated in this zone to keep them from being obstacles in the Throughway Zone. Planting in this zone must comply with the standards and guideline in this manual and the Landscape Technical Manual, particularly in the case of street tree well dimensions. The placement of these aforementioned elements must comply with the Land Development Code, San Diego Municipal Code and applicable Council Policies.

Installing pedestrian pop-outs is an effective way to increase sidewalk space for street furniture and other features. The dimension of the Furnishing Zone must consider whether street parking is provided (an effective buffer) and the speed of traffic.

## 3. Throughway Zone

The Throughway Zone is intended for pedestrian travel only and should be entirely clear of obstacles, including driveway aprons. This zone should be at least five feet wide. For high pedestrian volume areas, additional width should be provided. “Overhanging” elements, such as awnings, store signage, bay windows, etc., may occupy this zone as long as there is a clear distance under them of at least eight feet.

## 4. Frontage Zone

The Frontage Zone is the area adjacent to the property line that may be defined by a building façade, landscaping, or a fence. Generally, pedestrians do not feel comfortable moving at a full pace directly along a wall; and, because of this, the minimum frontage zone should be 1’6” in these situations. This is also the zone where pedestrians slow down and window-shop and enter and exit buildings. Adjacent businesses may use this zone for outdoor displays and seating, and municipalities must ensure that there is adequate space to accommodate these uses without impeding the Throughway Zone.

Architectural elements that encroach into the street, such as awnings, stairs, front stoops, artistic elements, planters, marquees, and the like may also occupy this zone. These elements add vitality and visual interest to the street but, nevertheless, must comply with local, state and Federal Regulations.

Where no Furnishings Zone exists, elements that would normally be sited there, such as benches, light poles, signals, trash cans, etc., may occupy the Frontage Zone in order to keep the Throughway Zone clear and maintain at least minimum ADA requirements

Where the sidewalk passes a parking lot, there should be some type of buffer, such as a hedge or a low wall in order to maintain a more aesthetic frontage along the sidewalk and prevent parked vehicles from overhanging into the Frontage Zone.

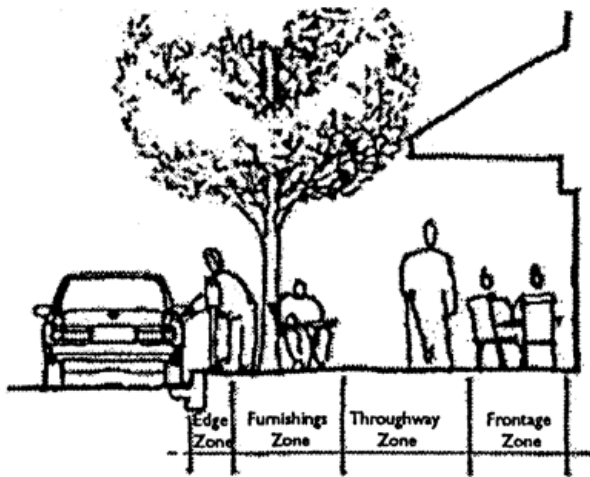

Pedestrian sidewalk zones

## F. Public Art and Amenities

Pedestrian improvements create a unique opportunity where people can see and be positively impacted by public art as part of their everyday activities; they also help create more walkable communities. Pedestrian improvements, which include public art, can convert ordinary spaces into places of meaning. Improvement projects constructed using public monies may designate a portion of their budget for public art.

### *Issues to Consider*

- On a large scale, public art has the ability to unify a neighborhood with a theme, and at a pedestrian level can provide visual interest for the passerby.
- Public art is an effective means of creating a neighborhood identity, and ideally should reflect the character and history of the community.
- Good design can encourage the use of streets for festivals, parades, and other cultural events that promote neighborhood pride and a sense of place.

### *Guidelines*

1. Public art should be located so as to be a pedestrian amenity without compromising safety.
2. When appropriate, consideration should be given to commissioning artists to create unique street elements such as light poles, benches, trash cans, manhole covers, tree grates, etc.
3. When appropriate, consideration should be given to a design that is conducive to using streets for festivals, parades, and other community events.



# Traffic Calming





## Traffic Calming

### A. Purpose

This section is intended to provide design options for traffic calming on new streets and streets being considered for retrofit. Some general design specifications are provided to assist designers in developing comprehensive streetscape plans for proposed development and redevelopment projects. It is emphasized that these are just guidelines and that innovative street designs that incorporate traffic calming are encouraged.

### B. Overview

Traffic calming involves the use of various geometric features designed to reduce vehicle speeds or discourage shortcutting traffic. To achieve the desired effect of traffic calming, the effectiveness of such measures and their impacts should be evaluated on an area-wide basis.

Landscaping, street trees, street lighting, and street furniture are other methods of traffic calming that also create distinctive and pleasing streetscapes that encourage sidewalk activity. These improvements may involve consideration of irrigation and long-term maintenance to be provided by maintenance assessment districts or other agreements with the City.

Traffic calming is appropriate along circulation element roads as well as commercial and residential local streets. Local streets should be designed to function efficiently and safely, yet minimize the need for extensive traffic regulation, control devices, and enforcement. The function of the local street should be readily apparent to the user through its appearance and design.

### C. General Guidelines

The following general guidelines should be considered in traffic calming installations:

- Delays to emergency vehicles should be minimized by the appropriate placement and design of traffic calming devices. In some cases, certain traffic calming devices may not be appropriate.
- Traffic calming installations should not divert traffic to other local residential streets. Traffic calming installations should support the street classifications established in community plans. Traffic may be diverted from residential streets to classified through streets. The potential impacts of traffic diversion should be evaluated for all traffic calming installations.
- Traffic calming devices on designated transit routes should be limited to those that permit the efficient movement of transit vehicles.
- Traffic calming installations must meet State and Federal accessibility requirements.
- Traffic calming should not impair the mobility of non-motorized users to of the street.
- Traffic calming installations must address drainage, sight distance, and location of underground utilities.
- All traffic calming installations are required to have a landscape element that includes trees and shrubs consistent with the Landscape Technical Manual. If traffic calming devices include decorative pavement, it shall comply with section E of the Design Standards in this Manual.

#### D. Traffic Calming Techniques

Traffic calming strategies generally fall into six categories:

- Horizontal deflections (chicanes, mini traffic circles, median slow points or chokers)
- Vertical deflections (road humps, speed tables, and raised crosswalks)
- Intersection pop-outs
- Traffic diverters (semi-diverters)
- Channelization

Enhancing the streetscape environment should have the same level of priority in the design scheme as traffic calming impacts. A general discussion of these categories follows along with more specific details and design guidelines for various traffic calming techniques.

Traffic calming" features such as median slow points or chokers, chicanes, mini traffic circles, and intersection 'pop-outs' may be provided in accordance with this design manual. Road humps or speed tables may be installed by the City on existing streets under some circumstances but should not be included in street construction or improvement projects.

#### E. Horizontal Deflections

Horizontal deflections are used to achieve speed reductions by breaking up the linear path of vehicle travel. Traffic calming designs that involve horizontal shifts in the travel way are inappropriate for major streets and arterials. Horizontal deflections include chicanes (mid-block) mini circles (intersections), and median slow points (mid-block and intersections).

*Chicanes* - A chicane is a channelization that causes a series of tight turns in opposite directions in an otherwise straight stretch or road. The combination of narrowed street width and the serpentine path of travel slows traffic. On new streets, chicanes narrow the street by widening the sidewalk or landscaped parkway. On streets considered for retrofit, raised islands are installed to narrow the street. The advantages of chicanes include: slow traffic, may create opportunity for landscaping, and tends not to divert traffic to nearby streets. Chicanes are inappropriate for use on streets classified as collector or higher, bus routes, emergency response routes, where there is a grade that exceeds 5 percent, or where there is limited stopping sight distance such as at the crest of a hill. Chicanes may cause some loss of on-street parking, may impact driveways, may increase emergency response time, or may affect drainage and street sweeping.

*Mini Circles* - A mini circle is a raised circular island placed in the center of an intersection. Traffic yields on entry, then enters to the right, traveling around the circle counter clockwise. A mini circle slows traffic on each approach, reduces right-of-way conflicts, creates a landscaping opportunity, and tends not to divert traffic to nearby streets. Mini circles are

appropriate for usage on low volume local residential streets with alternative access points. Mini circles should not be used on streets classified as collector or high, bus routes or emergency response route, where the grade exceeds 5 percent on any approach, or where there is limited stopping sight distance. A mini circle may impact large vehicles' turns or may increase emergency response time.

*Median Slow Points* - A median slow point is a small median or island placed in the center of a roadway that causes traffic to shift its path to the right in order to travel around it. It may be on an approach to an intersection or mid-block. If median slow points are installed at an intersection, the street should have alternative access points. A median slow point slows traffic, creates a pedestrian refuge area, creates a landscaping opportunity, and tends not to divert traffic to nearby streets. Median slow points may be used on two lane streets. It should not be used on streets classified as major or higher or where there is limited stopping sight distance. Median slow points may cause some loss of on-street parking or may impact large vehicles' turns when installed at intersections.

## **F. Vertical Deflections**

Vertical deflections are an effective traffic calming technique for speed reductions and discouraging shortcutting on local streets. Vertical shifts are only appropriate on two-lane streets. Traffic calming designs that involve vertical shifts are inappropriate for collector streets, major streets and arterials. Vertical deflections include road humps and speed tables/raised crosswalks.

*Road Humps* - Road humps are rounded raised areas placed across the road. Road humps are approximately 12 feet long (in the direction of travel), 3.5 inches high, and parabolic in shape. It is usually constructed with a taper on each side within a foot or two of the gutter line to allow unimpeded drainage between the hump and curb. They are most effective when used in groups that are spaced close enough to avoid encouraging speeding between humps. Road humps are different from speed bumps. Speed bumps are much more abrupt, usually less than three feet in length, and are used in parking lots and private drives. Speed bumps are not used on public streets.

While primarily used for speed reductions, road humps can also result in the reduction of traffic volumes on streets where they are employed by diverting traffic to other nearby streets. Road humps should not be used on streets classified as collector or higher, emergency response routes, bus routes, where grade exceeds 5 percent, or where there is limited stopping sight distance. The disadvantages of road humps may include diverting traffic to other low-volume local streets, increasing emergency response time, or increasing noise.

*Speed Tables/Raised Crosswalks* - Speed tables, essentially, are flat-topped road humps, often constructed with brick or other textured materials on the flat section. Speed tables are 3-1/2 inches high and 22 feet long in the direction of travel, with 6-foot ramps at the ends and a 10-foot field on top. The brick or other textured materials improve the appearance of speed tables and draw attention to them. Speed tables are less jarring than the standard 12 road humps. Speed tables are most effective when installed in groups of two or more, about 300 feet apart. Where extended from curb-to-curb and appropriately marked, speed tables serve as raised crosswalks. Raised crosswalks bring the street up to sidewalk level. Drainage requirements must be evaluated and addressed where raised crosswalks are installed.

Speed tables and raised crosswalks reduce vehicle speeds. Raised crosswalks enhance pedestrian safety. The disadvantages of speed tables/ raised crosswalks may include diverting traffic to nearby low-volume local streets, increasing noise and increasing emergency response times. Speed tables/raised crosswalks should not be installed on streets classified as collector or higher, emergency response routes, bus routes, where grade exceeds 5 percent, or where there is limited stopping sight distance.

### **G. Intersection Pop-outs**

Intersection pop-outs are curb extensions that narrow the street at intersections by widening the sidewalks at the point of crossing. They are used to make pedestrian crossings shorter and reduce the visual width of long, straight streets. Where intersection pop-outs are constructed by widening the landscaped planting strip, they can have a positive effect on the visual appearance of the neighborhood. Pop-outs can be used at intersections to create a street gateway effect, visually announcing an entrance to a neighborhood. Intersection pop-outs must accommodate bicyclists, transit vehicles and emergency response vehicles. Pop-outs improve pedestrian visibility, create shorter pedestrian crossing width, and may reduce vehicle speeds. Pop-outs may impact large vehicle turns, may impact accessibility by transit vehicles or emergency response vehicles, and may require parking removal. Intersection pop-outs may be installed on local streets, collector streets, and urban major streets. Pop-outs are inappropriate on major streets and primary arterials. The entire intersection should be designed and constructed at one time.

## H. Traffic Diverters

Traffic diversion devices eliminate through trips on streets on which they are installed and divert those trips to other streets. There are several available traffic diversion designs that may be used to calm traffic. Traffic diverters are not primarily installed for the purpose of speed control. Diverters are best suited on long, straight, low-volume, local residential streets. Wherever traffic diversion techniques are employed, provision should be made for continuation of pedestrian and bicycle routing around or through the diversion. Care must be taken in design of diversion installations to allow for emergency vehicles.

*Semi diverters.* - A semi diverter is a barrier to traffic in one direction of a street that permits traffic in the opposite direction to pass through. It is an alternative to one-way street operation for a block and it allows residents on the block limited two-way travel opportunity. A semi diverter may be used on low-volume, local residential streets and it is best located at the end of a block to prevent entrance and allow exit. Semi diverters reduce cut-through motorized vehicle traffic, reduce pedestrian crossing widths, and create opportunity for landscaping. Semi diverters may divert traffic to other low-volume streets, may increase trip lengths, may cause loss of parking, and may increase emergency response time. Semi diverters are inappropriate for use on emergency response routes, bus routes, or streets classified as collector or higher. No specific geometric features are included in this manual since semi diverters are site specific and should be designed on a case-by-case basis.

## I. Channelization

Channelization may be used on arterial streets to prevent cut-through traffic onto local streets or to control turning traffic in or out of a neighborhood. Channelization can be achieved through regulatory signs and pavement markings, landscaping, or raised channelization islands aimed at motorized, non-motorized, or pedestrian traffic. Channelization may be designed to prevent cut-through traffic, reduce speed, create opportunity for landscaping, control turning traffic in and out of a neighborhood, or physically guide pedestrians. The disadvantages of channelization may include creating out-of-direction travel, increasing trip lengths, increasing emergency response time, or impacting accessibility. No specific geometric features are included in this manual since channelization devices are site specific and should be designed on a case-by-case basis.

# Tc Traffic Calming -Chicane

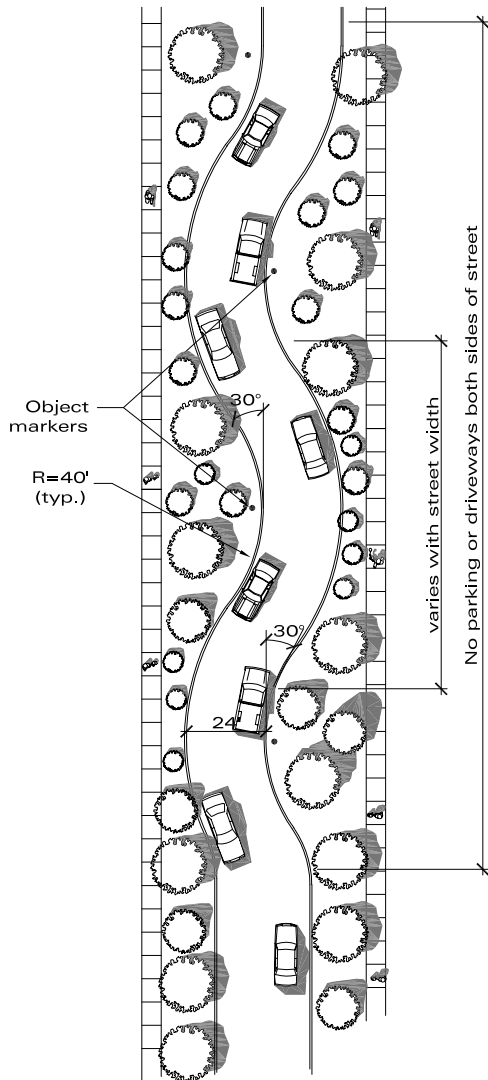
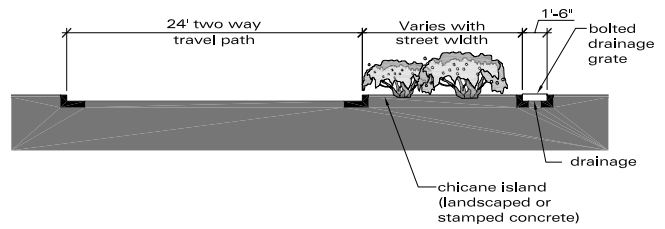

**New Installations**

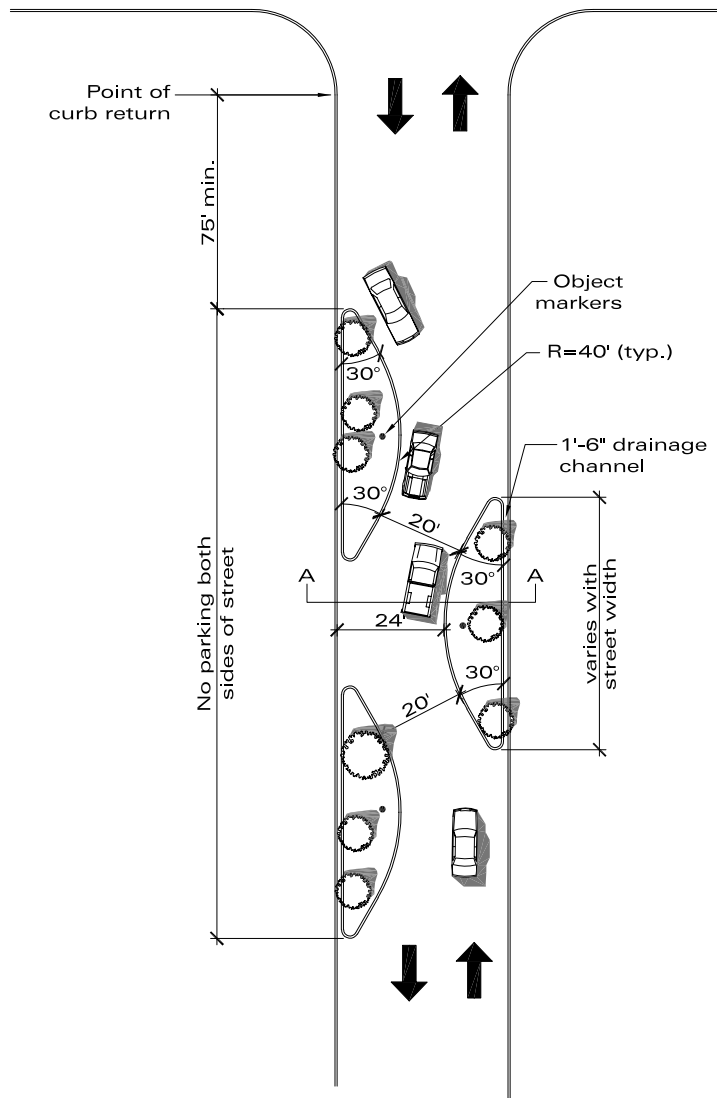

**Retrofit Installations**



**NOTES:**

- \* Spacing of chicane segments depend on site considerations, e.g. driveway locations.
- \* Island plantings should not obscure driver's view of chicane traffic (24" maximum height).
- \* Stamped concrete may be used in the chicane island.
- \* Bicycles are to use the same path as motor vehicles, not the drainage channel.



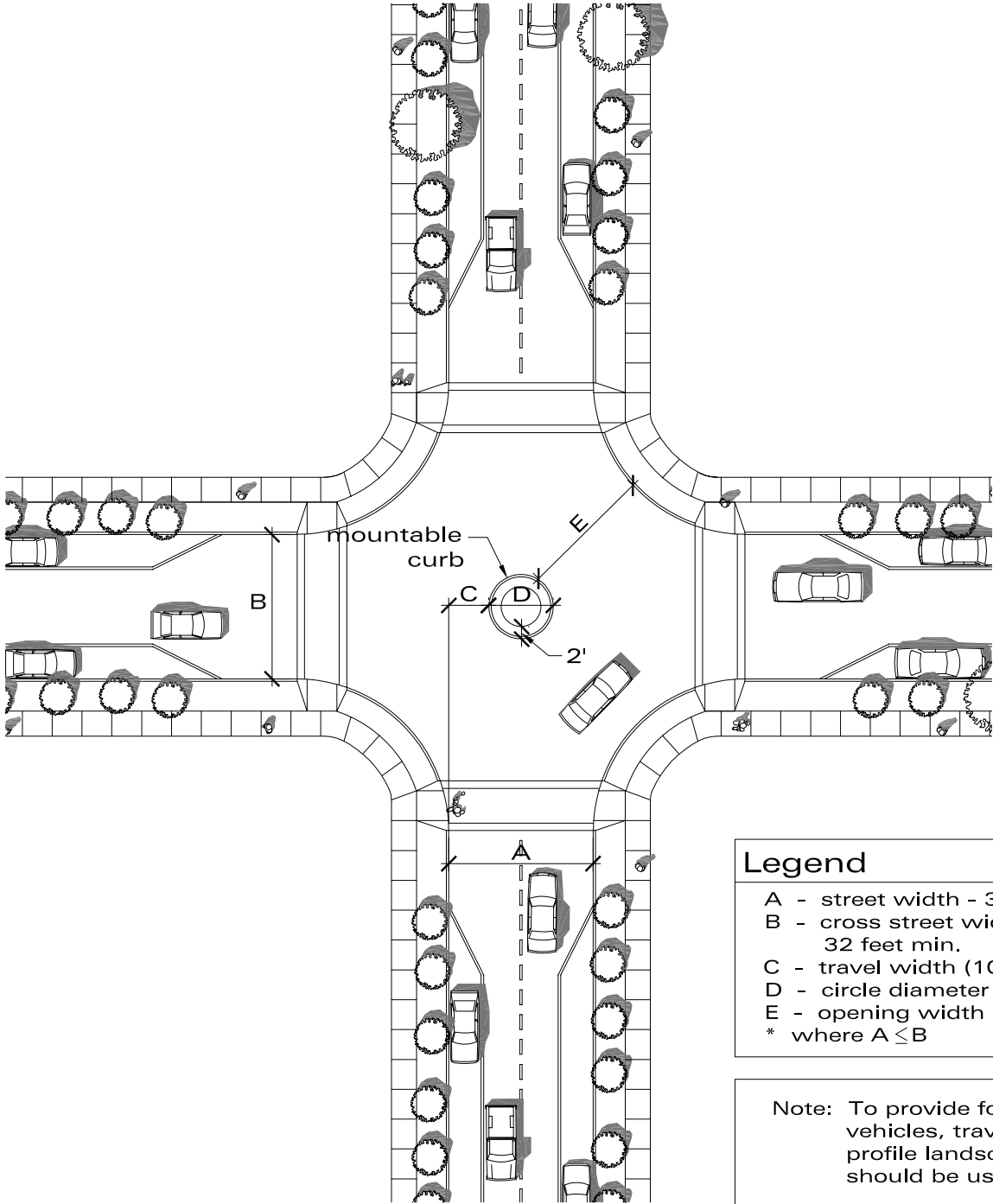

Legend	
A	- street width - 32 feet min.
B	- cross street width (varies) 32 feet min.
C	- travel width (10'*)
D	- circle diameter (12' minimum)
E	- opening width (18' minimum)
* where $A \leq B$	

Note: To provide for emergency vehicles, traversable low profile landscaping should be used.

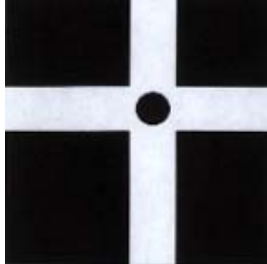

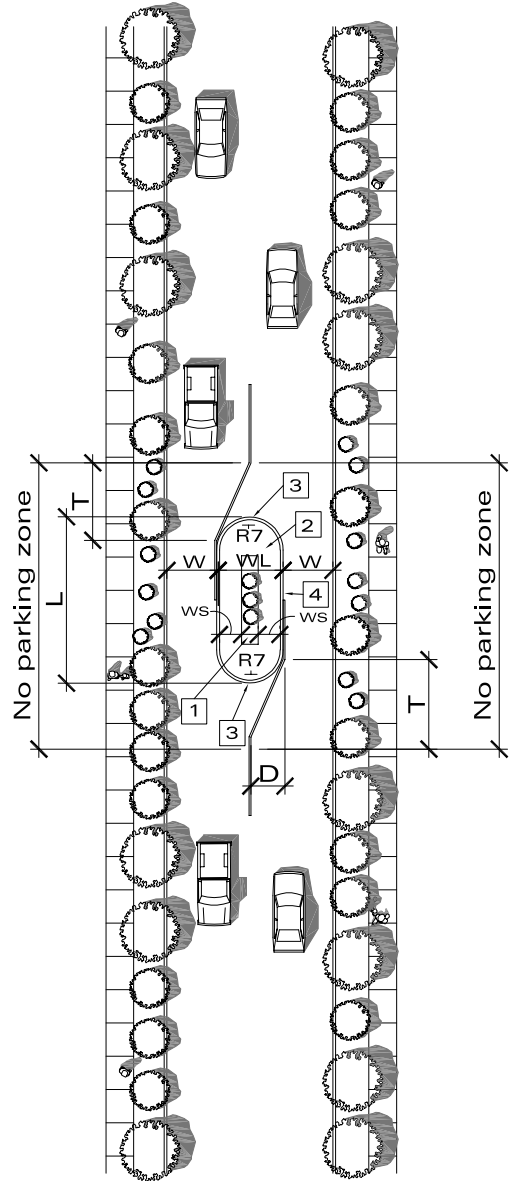
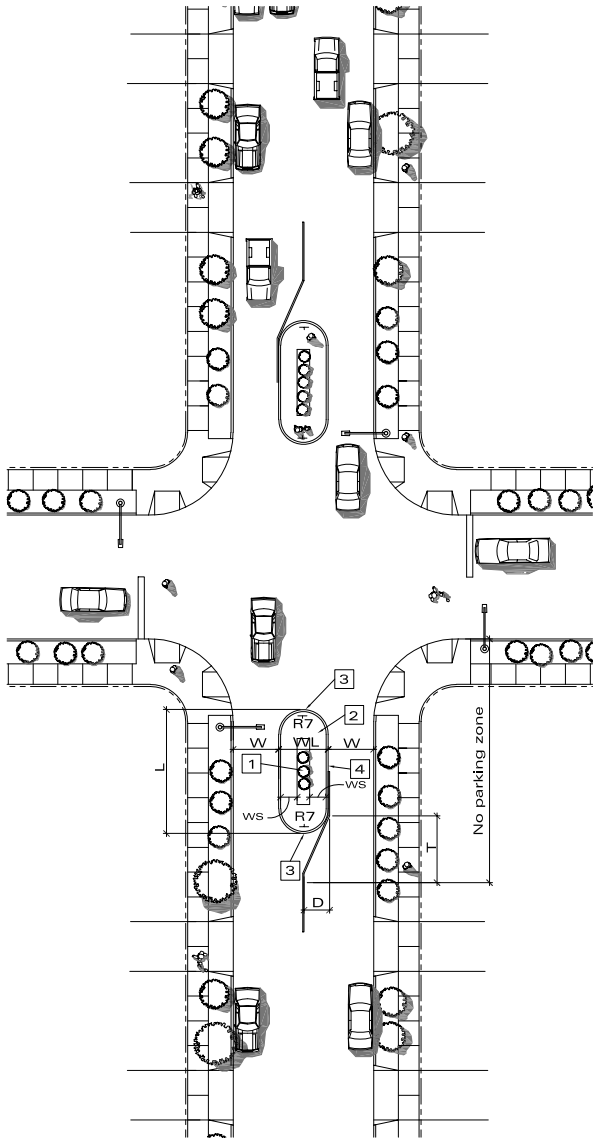

**Legend**

- 1 area that may be landscaped (landscape, irrigation, and long term maintenance must be considered by a maintenance assessment district or other agreements with the City of San Diego.)
- 2 stamped concrete
- 3 yellow painted island nose
- 4 6" curb

W - travel lane width - 14'  
 WL- Width of slow point (varies depending on street width- 12' minimum)  
 WS - For landscaped slow point, 2' typical  
 L - Length of slow point, varies depending on parking and driveways  
 D - horizontal deflection, 6' minimum  
 T - Transition, calculated as follows:  
 $T = (D \times S^2) / 120$  - minimum  
 Where: D= deflection in feet  
 S= 85th percentile speed in mph

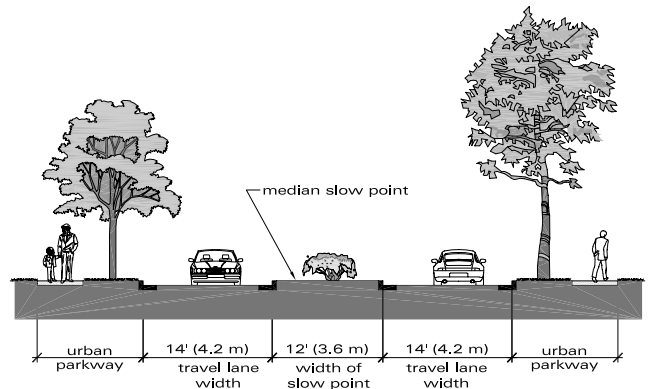

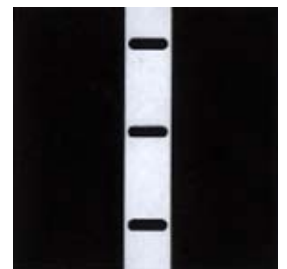
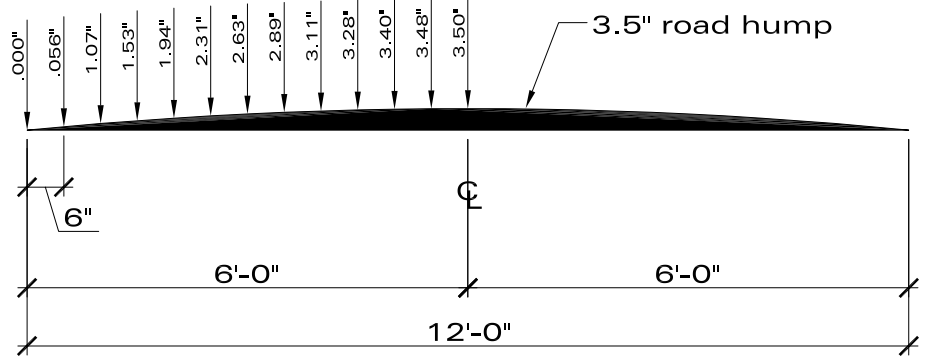
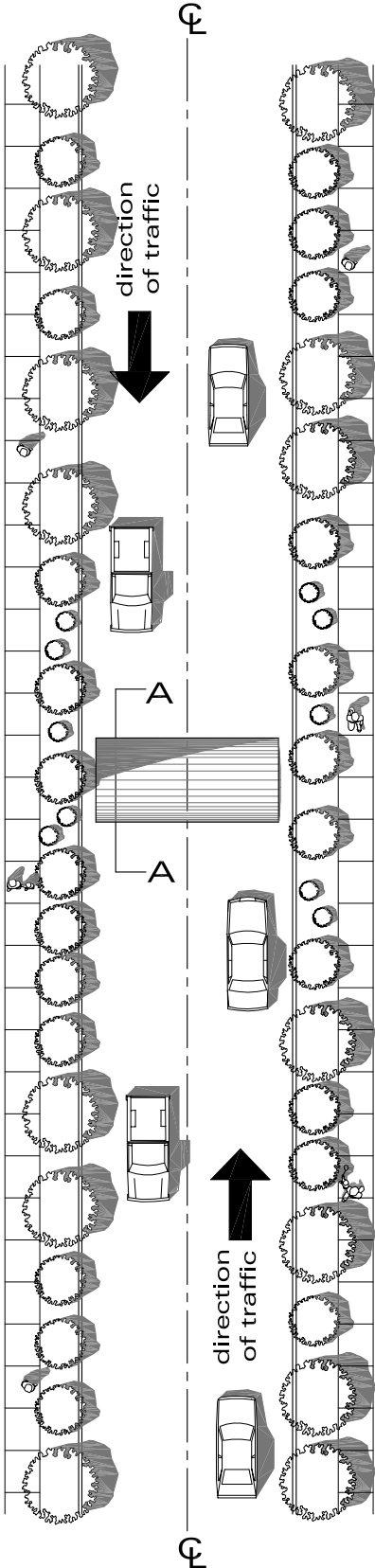

# Tc Traffic Calming -Speed Table

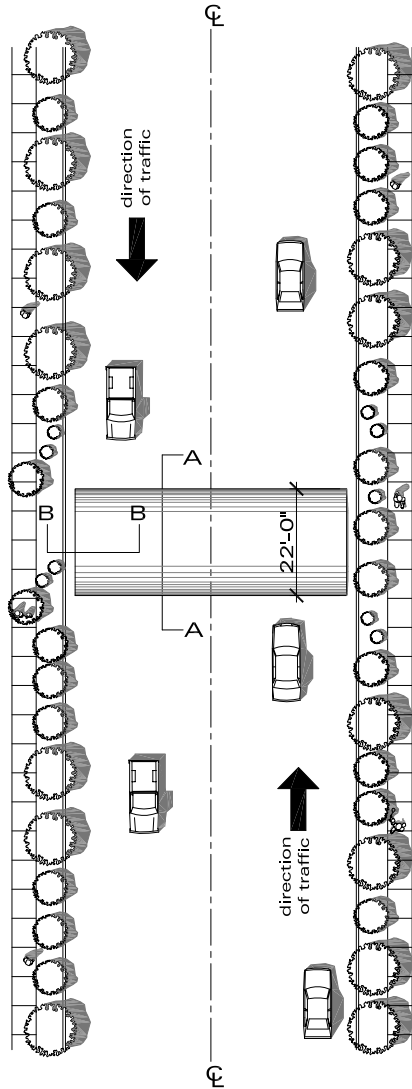

**NOTE:**  
• Drainage requirements must be evaluated and addressed.

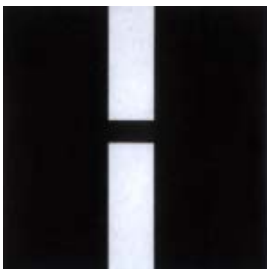
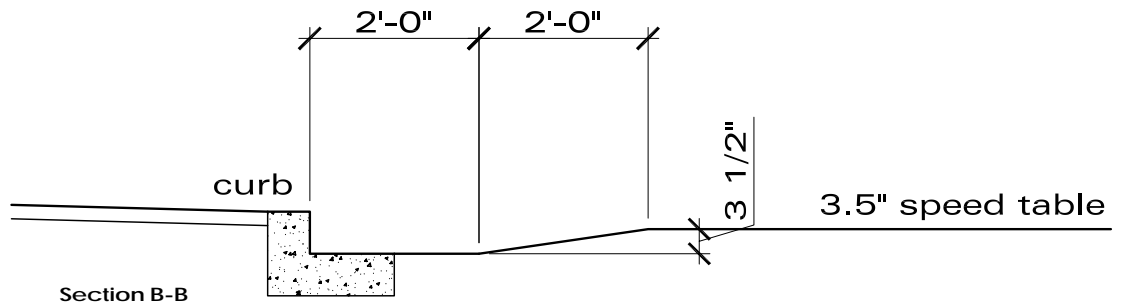
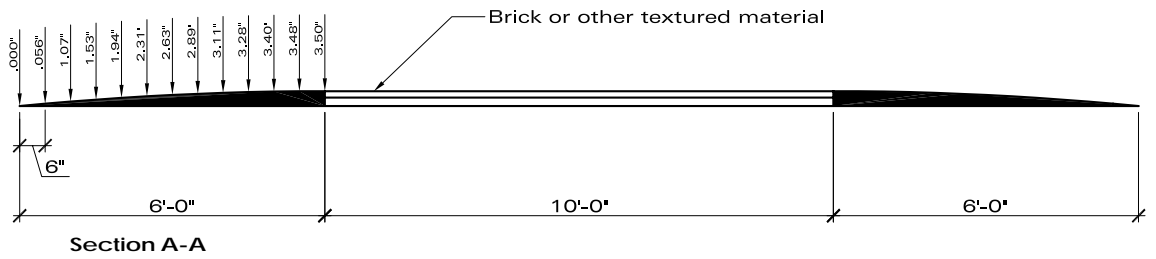

**NOTES:**  
 \* Drainage requirements must be evaluated and addressed.  
 \* Crosswalks should meet traffic engineering requirements approved by the City Council. Refer to Policy 200-07.

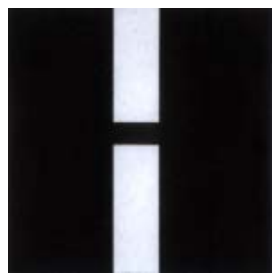
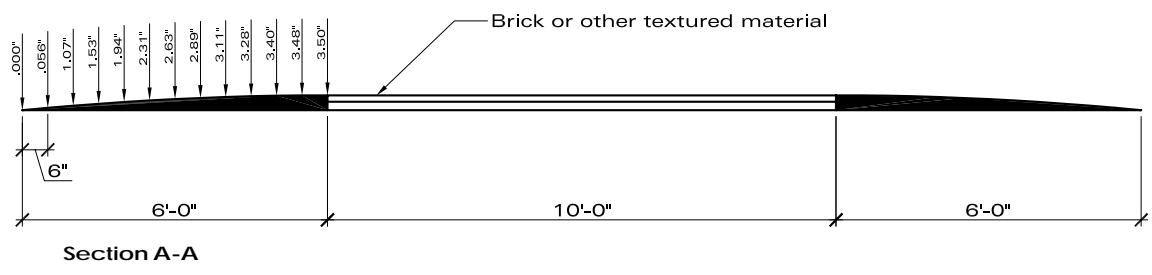
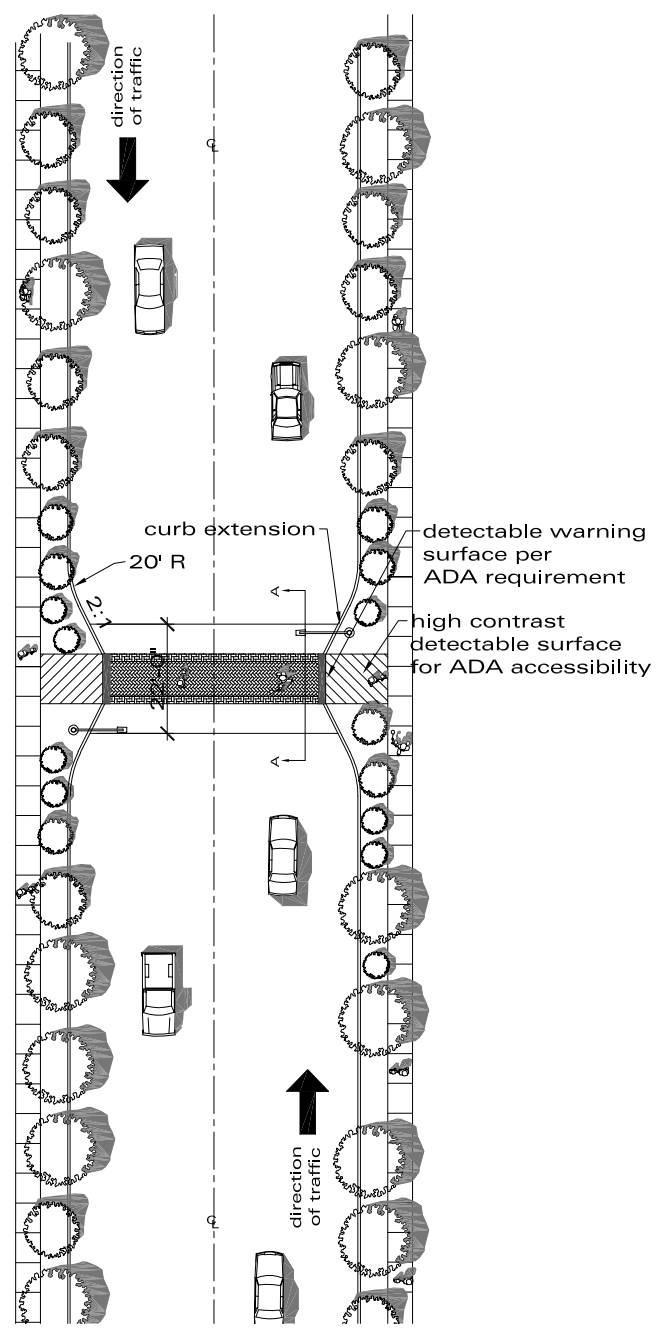



# Traffic Calming -Intersection Pop-out

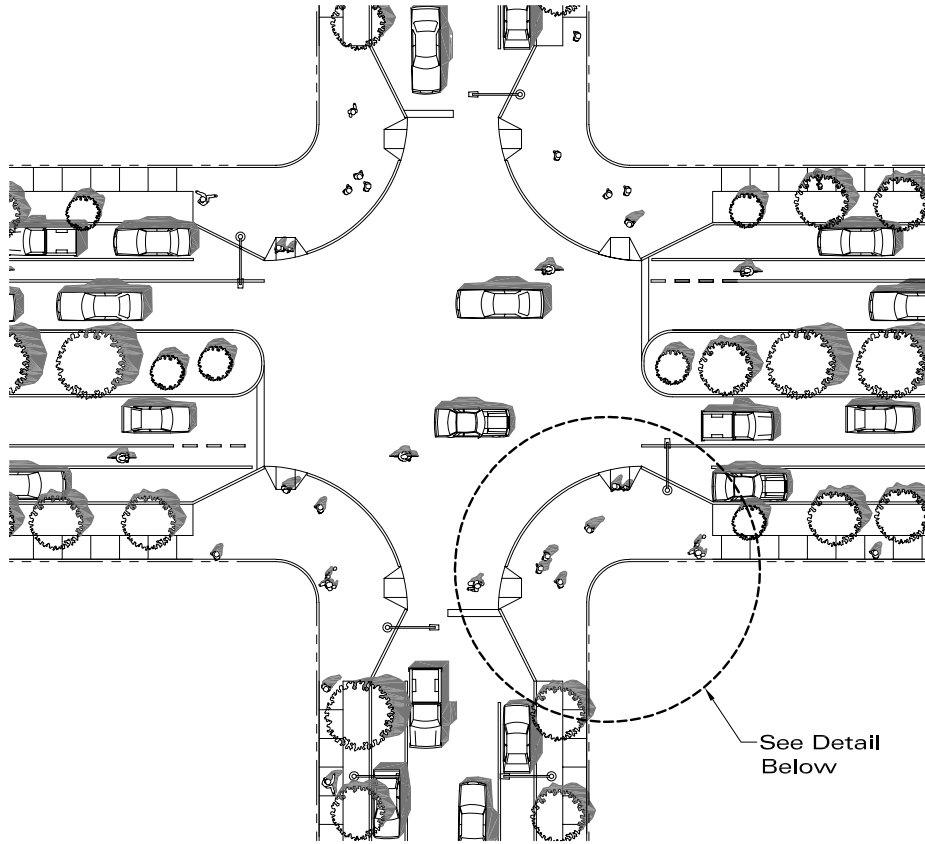

See Detail Below

**NOTE:**  
 \* Drainage requirements must be evaluated and addressed.

**Legend**  
 RCP - 30' (9.2 m) minimum  
 RCO - Retrofit installations- original curb radius  
 R1 - Curb radius 20' (6 m)

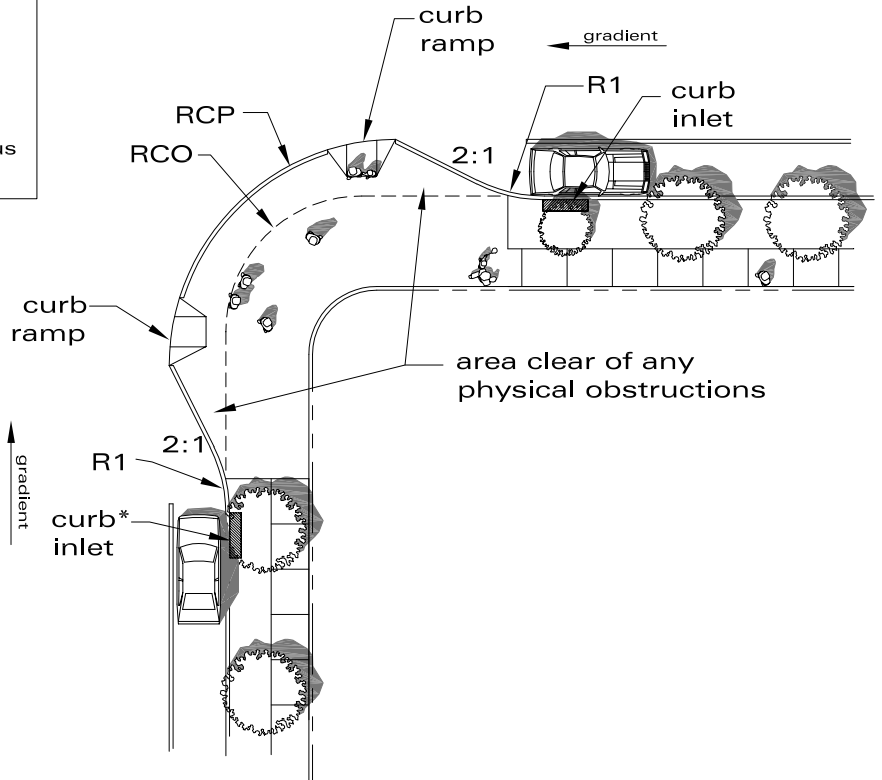

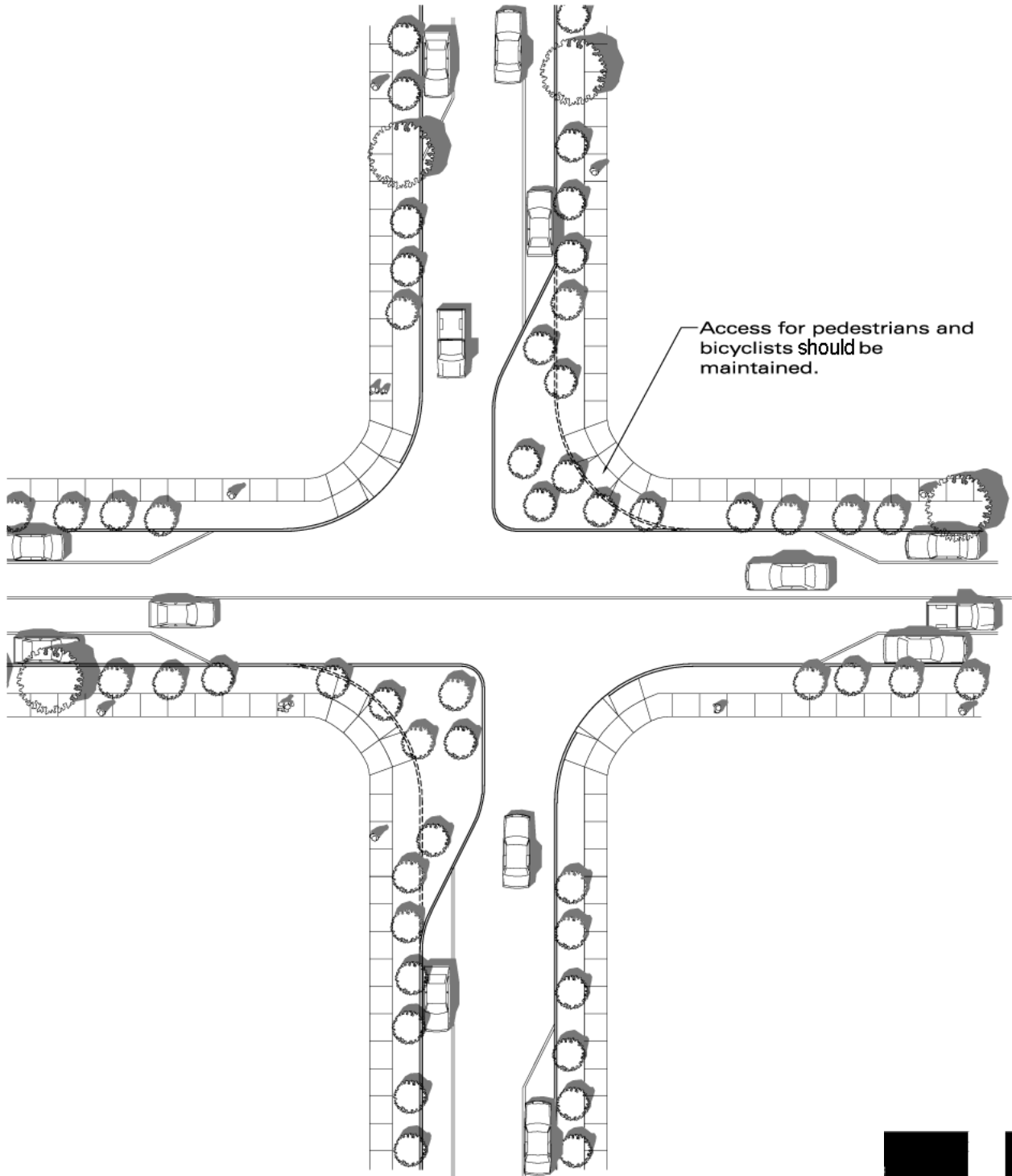

For illustrative puposes only

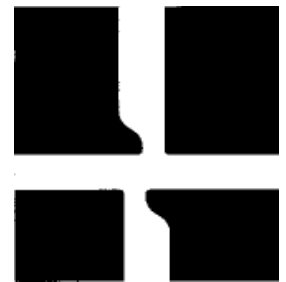



# Traffic Calming -Channelization

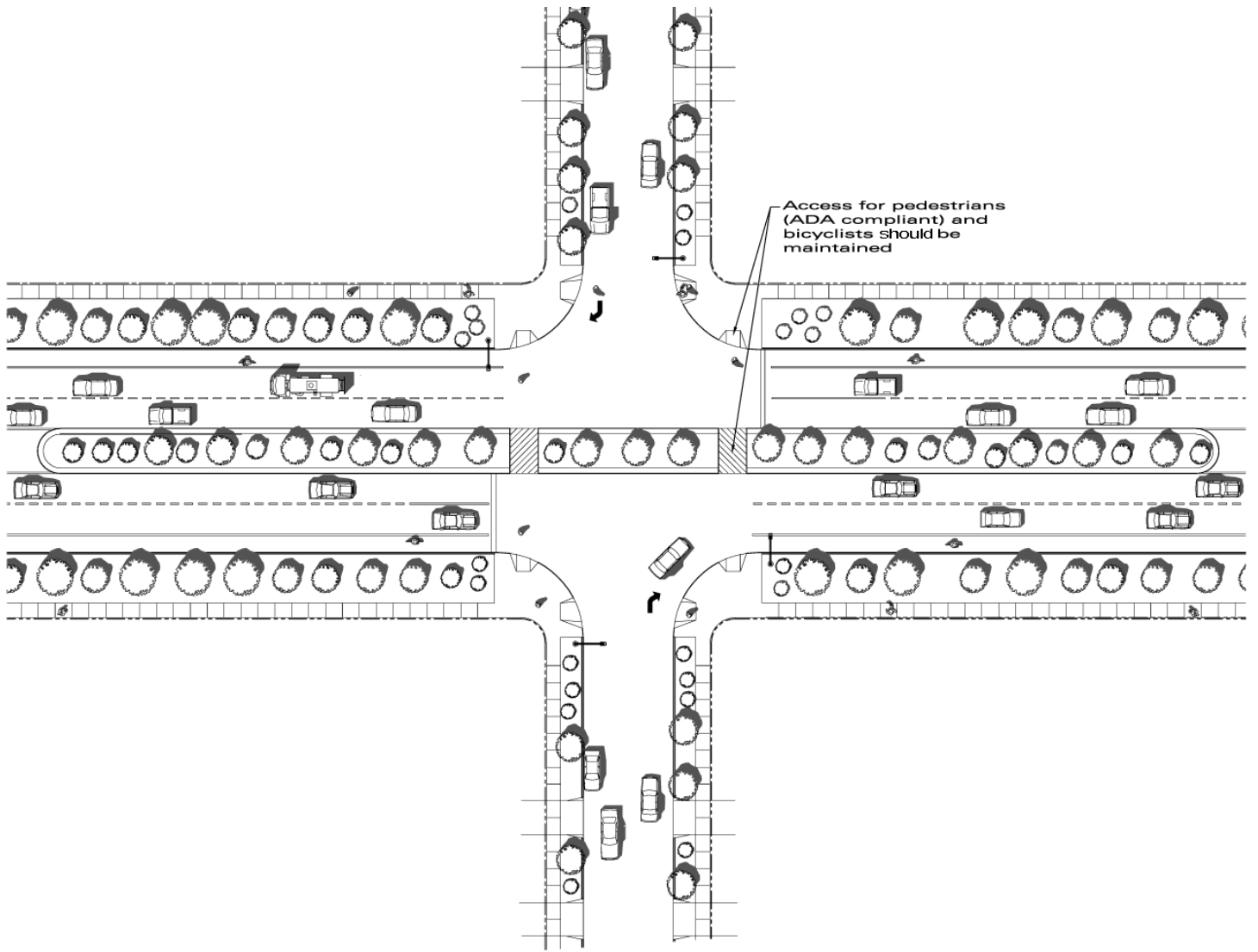

For illustrative purposes only

