

# San Diego Multiple Species Conservation Program (MSCP) Rare Plant Monitoring Review and Revision

By Kathryn McEachern, Bruce M. Pavlik, Jon Rebman, and Rob Sutter



Western Ecological Research Center

Scientific Investigations Report 2007–5016

**U.S. Department of the Interior**  
**U.S. Geological Survey**

**U.S. Department of the Interior**  
DIRK KEMPTHORNE, Secretary

**U.S. Geological Survey**  
Mark D. Myers, Director

U.S. Geological Survey, Reston, Virginia: 2007

For product and ordering information:

World Wide Web: <http://www.usgs.gov/pubprod>

Telephone: 1-888-ASK-USGS

For more information on the USGS--the Federal source for science about the Earth, its natural and living resources, natural hazards, and the environment:

World Wide Web: <http://www.usgs.gov>

Telephone: 1-888-ASK-USGS

Any use of trade, product, or firm names is for descriptive purposes only and does not imply endorsement by the U.S. Government.

Although this report is in the public domain, permission must be secured from the individual copyright owners to reproduce any copyrighted materials contained within this report.

Suggested reference:

McEachern, Kathryn, Pavlik, Bruce, Rebman, Jon, and Sutter, Rob, 2007, San Diego Multiple Species Conservation Program (MSCP) rare plant monitoring review and revision: U.S. Geological Survey Scientific Investigations Report 2007-5016, 68 p.

# Contents

Executive Summary .....	1
I. Introduction .....	2
Objectives.....	2
Program Status.....	2
Vision for Effective Conservation .....	5
II. Summary of Review Comments .....	5
III. Detailed Review with Recommendations .....	5
Linking Current Population Status to Local and Regional Management for Conservation of the Species .....	5
Ensuring that Feedback and Oversight Mechanisms Work in Both Local Jurisdictions and Regional Agencies .....	6
Appropriate Types of Monitoring: Status, Trend, and Effectiveness Monitoring .....	7
Assessment of Current Trend Monitoring Data for Detecting Change.....	8
Developing a System for Data Archiving.....	9
Standardizing Survey Methodology .....	9
Verifying Rare Plant Taxonomy with Vouchered Specimens .....	9
Summary of Review and Recommendations .....	9
IV. Adaptive Management Framework for the MSCP .....	10
The Concept of Adaptive Management .....	10
Implementing Adaptive Management.....	10
V. New Monitoring Framework and Methodologies .....	12
A New Framework for MSCP Rare Plants Monitoring .....	12
Adaptive Management Working Group (AMWG).....	13
Technical Advisory Group (TAG) .....	13
Structured Flow of Information .....	14
Monitoring and Management Plans for Each Covered Species .....	14
Rare Plant Management Unit Definition .....	15
Characteristics of Rare Plant Management Units .....	15
Rare Plant Management Unit Characterization.....	15
Monitoring and Management Plan development.....	16
Goals and Objectives for Rare Plant Management Units .....	17
Rare Plant Management Regimes .....	17
Types of Monitoring Design .....	18
Sampling Design .....	19
Annual Program Review: Peer Presentations and External Review.....	19
Annual Assessment of Success.....	19
A Regional Data Hub for Monitoring .....	19
Summary of New Framework and Methodologies .....	21
VI. Recommended Implementation Schedule and Benchmarks .....	21
VII. Conclusions.....	21
VIII. Acknowledgments.....	22
IX. Literature Cited .....	22

Appendix A. San Diego Multiple Species Conservation Program Covered Rare Plants: Summary of surveys and monitoring across jurisdictions .....	26
Appendix B. Assessment of Current Monitoring Data for Detecting Change (the Success of the Multiple Species Conservation Program (MSCP)).....	37
Appendix C. Methodology for Collecting and Recording Voucher Specimens .....	41
Appendix D. A Practical Guide for Development of San Diego Multiple Species Conservation Program (MSCP) Rare Plant Monitoring and Management Plans .....	45
Appendix E. Monitoring and Management Plan Draft Example: Monitoring and Management Plan for <i>Ambrosia pumila</i> .....	51

## Figures

Figure 1. Jurisdictions participating in the San Diego Multiple Speices Conservation Program (MSCP) .....	3
Figure 2. San Diego Multiple Speices Conservation Program (MSCP) sensitive plant distribution across jurisdictions .....	4
Figure 3. The process of adaptive management envisioned as a cycle .....	11
Figure 4. Controversy matrix in Resource Management.....	11
Figure 5. Key Management Questions (KMQs) help focus science to realize the management vision set by goals and objectives .....	12
Figure 6. Information flow during adaptive management .....	14
Figure B1. <i>Dudleya brevifolia</i> ssp. <i>brevifolia</i> monitoring data for Carmel Mountain subpopulation 3 .....	38
Figure B2. Changes in the number of individuals of <i>Dudleya variegata</i> in belt transects at Otay Lakes from 2003 to 2005 .....	39
Figure C1. Standard plant press (from: Simpson, M.G. 1997 Plant Collecting and Documentation Field Notebook). SDSU Herbarium Press .....	42
Figure E1. <i>Ambrosia pumila</i> locations in the San Diego Multiple Species Conservation Program (MSCP).....	59

## Tables

Table 1. Major issues emerging from MSCP rare plants monitoring program review .....	5
Table 2. Steps in Multiple Species Conservation Program (MSCP) rare plant Monitoring and Management Plan development .....	16
Table 3. Recommended rare plant adaptive management implementation schedule .....	21
Table D1. Steps in MSCP Monitoring and Management Plan Development.....	45
Table D2. Questionnaire for Monitoring and Management Planning. ....	46
Table D3. Monitoring and Management Plan Template .....	48
Table D4. Management Unit Characterization Form .....	52
Table E1. San Diego ambrosia ( <i>Ambrosia pumila</i> ) Management Units within the San Diego Multiple Species Conservation Program. ....	53
Table E2. City of San Diego monitoring metadata for <i>Ambrosia pumila</i> quantitative transect monitoring at parcel C6 .....	56
Table E3. City of San Diego summary—Plant density and population size .....	56
Table E4. City of San Diego summary—Total plants sampled .....	56

## Abbreviations

AMWG	Adaptive Management Working Group
BIOS	biogeographic database (California Department of Fish and Game)
BLM	Bureau of Land Management (U.S.)
BMP	best available management practice
CalcStDev	calculated standard deviation
CalcVar	calculated variance
CDFG	California Department of Fish and Game
commun.	communication
DOD	Dept. of Defense
DFG	Department of Fish and Game (California)
ft	foot
GIS	Geographical Information System
GPS	Global Positioning System
HCP	Habitat Conservation Plan
KMQ	Key Management Question
m	meter
m <sup>2</sup>	square meter
mi	mile
mm	millimeter
MSCP	Multiple Species Conservation Program
MTRP	Mission Trails Regional Park
MU	Management Unit
NCCP	Natural Community Conservation Planning
NPS	National Park Service
SANDAG	San Diego Area Governments
SDNWR	San Diego National Wildlife Refuge
SDSU	San Diego State University
TAG	Technical Advisory Group
TPST	Torrey Pines State Reserve
TNC	The Nature Conservancy
USFWS	U.S. Fish and Wildlife Service
USGS	U.S. Geological Survey
UTM	Universal Transverse Mercator

This page intentionally left blank.

# San Diego Multiple Species Conservation Program (MSCP) Rare Plant Monitoring Review and Revision

By Kathryn McEachern, Bruce M. Pavlik, Jon Rebman, and Rob Sutter

## Executive Summary

The San Diego Multiple Species Conservation Program (MSCP) was developed for the conservation of plants and animals in the southern part of San Diego County, under the California Natural Community Conservation Planning Act of 1991 and the Federal Endangered Species Act of 1973, as amended. Forty-two plant taxa are targeted for conservation management under the Program. Fifteen southern San Diego jurisdictions are signatory to the MSCP, ranging from large land management agencies, including the U.S. Fish and Wildlife Service (USFWS) and the County and City of San Diego, to cities with relatively small land areas. Thus far, there is uneven implementation of the program across jurisdictions, with available information ranging from incomplete surveys to annual quantitative monitoring data. This review was conducted during 2005 and 2006, with the objectives of bringing together regional information on the rare plant monitoring program, providing a technical assessment of program performance, and providing recommendations for improved monitoring program design.

We reviewed documents, made rare plant site visits with agency staff, compiled survey and monitoring results, entered and analyzed data, held two technical workshops with agency staff, consultants, and university scientists, and conducted two public workshops to get feedback on the program. We considered program vision and structure, implementation plans, available data, and institutional support of the current monitoring efforts. Here we provide a summary of the current status of the rare plant monitoring program, discuss concerns raised by the review team and others during the review, and provide recommendations for a revised rare plant monitoring framework built on the core concepts of effective conservation and adaptive management.

In general, the program has been very effective at land protection for rare plant conservation, and monitoring has focused mainly on surveys for the presence or absence of rare plant populations. However, the MSCP is in transition now from a program focused on land acquisition to one of land management and monitoring. Current monitoring plans call for status and trend monitoring of key populations. However,

agency efforts to implement this protocol and the resulting data show that such monitoring requires sampling effort that is out of the fiscal and logistical reach of most jurisdictions. Further, monitoring results provide little feedback on effects of management practices, hampering efforts to effectively conserve populations and their habitats. Finally, a regional compilation of monitoring methods, results, and plans is not available, so that regional review of the status of the conserved taxa is not possible. These and other major issues that emerged during the review are discussed in detail as a series of comments and recommendations on various rare plant monitoring program areas.

We propose a revision of the rare plant monitoring program using the concepts and methods of adaptive management. We recommend monitoring to address the “key management questions” that need to be answered for each species, coupled with feedback to management along structured pathways of information flow. Such a program would utilize a variety of monitoring approaches, including qualitative status checks, trend monitoring, and hypothesis-based effectiveness and validation monitoring.

We provide a discussion of the concept of adaptive management, and present the framework for a program linking management and monitoring. In particular, we recommend the development of a regional adaptive management working group, with a technical advisory sub-committee, to plan species conservation at the regional level. We present a detailed methodology for management and monitoring plan development for MSCP taxa, and present an example plan for the endangered San Diego ambrosia (*Ambrosia pumila*). We present a structure for a regional data hub, where MSCP plans and results can be accumulated and summarized annually.

The San Diego MSCP is on the leading edge of conservation, in one of the most rapidly developing urban areas in the nation. It has thus far been very successful at acquiring conservation lands to protect habitats and rare species. As the rare plant monitoring component moves toward increased emphasis on management and monitoring, it could benefit from adjustments to ensure that it remains responsive to changing conditions, provides information for management, and uses new concepts and methods in conservation biology.

## I. Introduction

The San Diego Multiple Species Conservation Program (MSCP) was developed for the conservation of plants and animals in the south part of San Diego County, under the California Natural Community Conservation Planning Act of 1991 (California Department of Fish and Game) and the Federal Endangered Species Act of 1973, as amended (16 U.S. Code 1531–1544.) The Program is on the leading edge of conservation, as it seeks to both guide development and conserve at-risk species with the oversight of both State and Federal agencies. Lands were identified for inclusion in the MSCP based on their value as habitat for at-risk plants or plant communities (Natural Community Conservation Planning, 2005). Since its inception in the mid-1990s the Program has protected over 100,000 acres, involving 15 jurisdictions and the U.S. Fish and Wildlife Service (USFWS) and California Department of Fish and Game (CDFG) in the conservation of 87 taxa (figure 1). Surveys for covered species have been conducted, and management and monitoring have been implemented at some high priority sites. Each jurisdiction or agency manages and monitors their conservation areas independently, while collaborating regionally for long-term protection.

The San Diego MSCP is on the forefront of conservation, in one of the most rapidly growing urban areas of the country. The planning effort that developed the MSCP was state-of-the-art, using expert knowledge, spatial habitat modeling, and principles of preserve design to identify and prioritize areas for protection. Land acquisition and protection are ahead of schedule for most jurisdictions. Surveys have verified the locations of many rare plant populations known from earlier collections, and they provide general information on population size and health useful for further conservation planning. Management plans have been written or are in development for most MSCP parcels under jurisdictional control. Several agencies are developing databases for implementation and management tracking. In many ways this program is at the cutting edge of regional conservation, testing concepts, developing techniques, and demonstrating conservation effectiveness in new and uncharted ways. Periodic program review is crucial to the continued success of the program, as it moves from a phase of planning and acquisition to one of management and monitoring.

Ecological monitoring is the key to assessing the success of the protection and management implemented at each individual reserve and for the MSCP as a whole. The ultimate goal of the Program is conservation of at-risk taxa and their habitats, as well as underlying ecological processes that contribute to sustainability of the ecosystem. Monitoring guidelines and timetables were developed by Ogden Environmental and Energy Services Co., Inc. (1996), and reviewed by Conservation Biology Institute (2001). The Program is in transition now, from the initial stage of land protection to one of land management and monitoring to determine population responses to management regimes. Several agencies have already invested substantial effort in status and trend

monitoring, while others are developing their monitoring plans. Management is ongoing at several sites. With both management and monitoring, collaboration and coordination among jurisdictions can be especially fruitful in conserving resources and maximizing success.

## Objectives

The objectives of this document are to review the current status of the component of the monitoring program that focuses on rare plants, and to make recommendations for an efficient program design that propels conservation forward in the region. For conservation to be effective, ecological monitoring must be efficient and sustainable, responsive to agency management needs, regionally integrated, and flexible enough to respond to emerging issues as they arise. The monitoring must be focused on the assessment of how populations of MSCP taxa respond to management regimes and particular management actions. Thus, this review takes a look at program vision and structure, implementation plans, available data, and institutional support of the current monitoring efforts. We provide recommendations for a revised rare plant monitoring framework based on current concepts in conservation biology (especially adaptive management), data analyses, and agency and stakeholder feedback. We use the framework to develop an example Monitoring and Management Plan protocol for San Diego ambrosia (*Ambrosia pumila*).

## Program Status

Rare plant conservation targets were developed in the early 1990s using expert knowledge and GIS modeling of plant population sizes, distribution, and habitat relationships (J.A. Stalcup, Conservation Biology Institute, oral commun., 2005; and T. Oberbauer, County of San Diego, oral commun., 2005). Program focus to date has been on land acquisition and inventory, with acquisition 60–80 percent complete across the major landowners of the City and County of San Diego, USFWS, CDFG, and Bureau of Land Management (BLM). Several of the 15 participating jurisdictions have signed MSCP Implementing Agreements (Natural Community Conservation Planning, 2005) with USFWS and CDFG. Activities are split between land surveys to locate and characterize the rare plant populations, and census or quantitative monitoring for status and trends. Figure 2 shows the distribution across jurisdictions of sensitive plants covered by the MSCP, and Appendix A provides a master table showing survey, census, and quantitative monitoring activities conducted for each taxon since MSCP inception. The largest jurisdictions are the farthest along in their implementation, mainly because they had, or were able to develop, funding mechanisms and put staff in place to immediately begin MSCP-related work. Other jurisdictions can take advantage of this experience by using the ecological understanding developed through surveys and monitoring, and by evaluating the institutional structures that create an effective environment for conservation management.



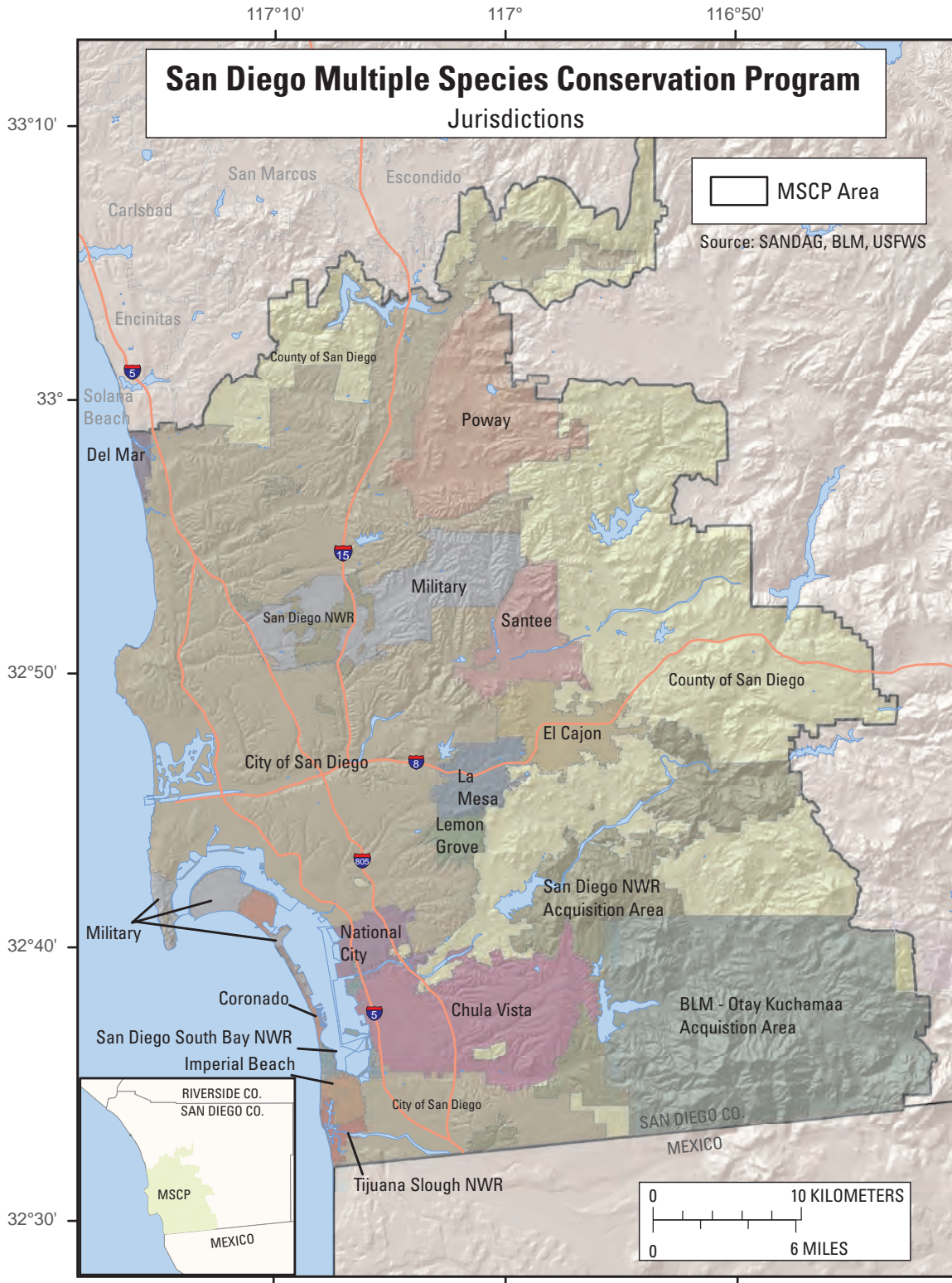

**Figure 1.** Jurisdictions participating in the San Diego Multiple Species Conservation Program (MSCP).

4 San Diego Multiple Species Conservation Program (MSCP) Rare Plant Monitoring Review and Revision

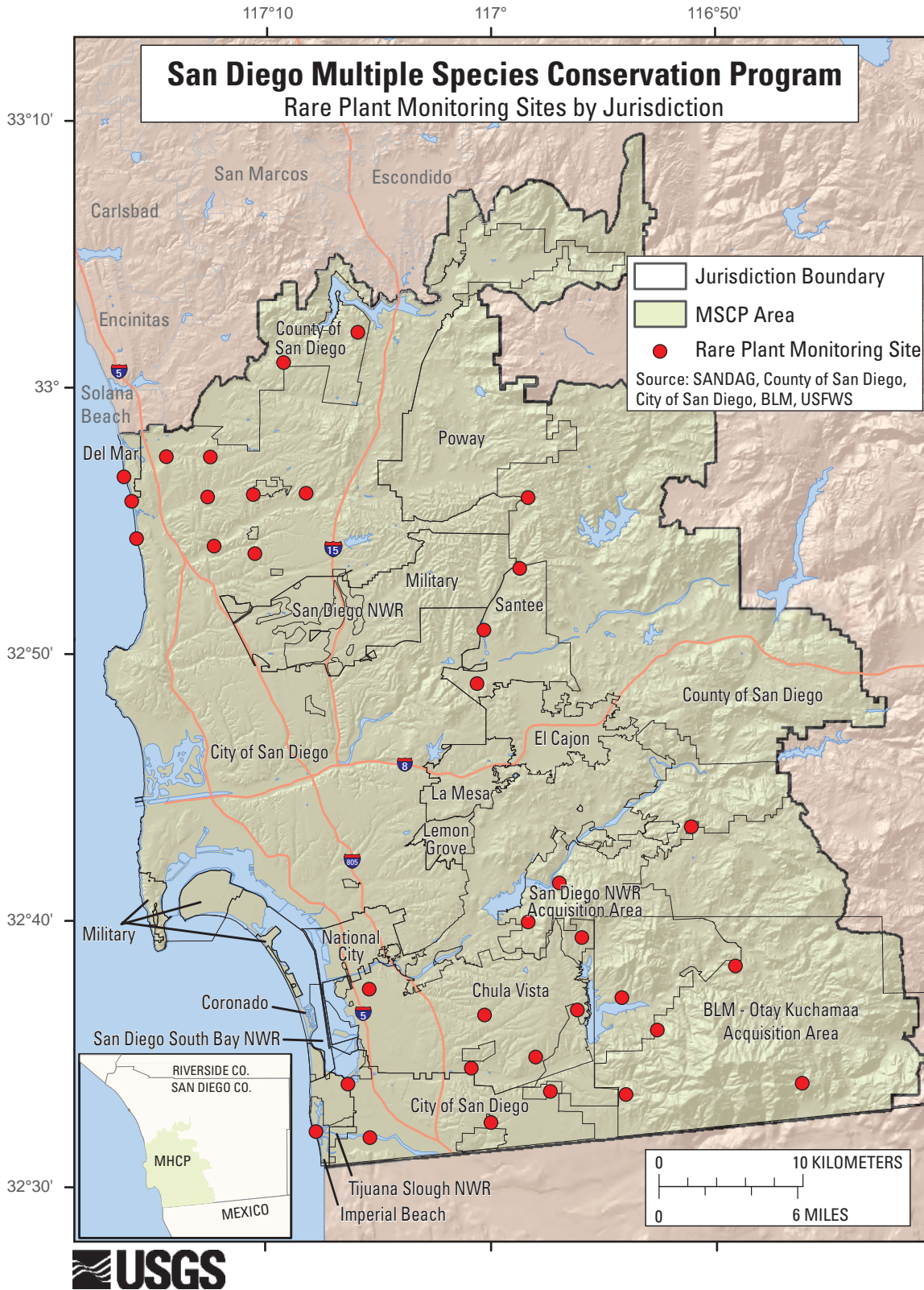

Figure 2. San Diego Multiple Species Conservation Program (MSCP) sensitive plant distribution across jurisdictions.

## Vision for Effective Conservation

The ultimate measure of success for the MSCP is the effective conservation of covered species. Effective conservation is the combination of land protection, threat abatement, and land or habitat management that results in the viability and long-term persistence of wild populations. While land protection is an essential first step, in itself it does not guarantee long-term conservation of a population or its habitat. Protected lands still have threats (for example, off-road vehicles, trampling) that need to be abated or eliminated and need land and species management (invasive species removal, restoration of natural fire or hydrology) to maintain or enhance a population of concern. In some situations, protection efforts may effectively conserve a population or habitat (for example, Lakeside ceanothus on the Crestridge reserve). In many others, active management is needed to abate threats and enhance condition. In any case, active management initially should only be done under careful experimentation on a pilot scale, with the results informing long-term management at the larger scale.

This vision focuses on strengthening the ultimate goal of the MSCP using the perspective of effective conservation. In addition to addressing the implementation of ecological monitoring, this report recommends an institutional framework for an effective conservation program. The framework includes the development of monitoring and management plans for covered rare plant species that strengthen the implementation and evaluation of management and conservation actions, and a process to collaborate, communicate, review, and archive the actions of conservation across all species and lands in the MSCP. The concept of adaptive management is integrated into the recommendations. The MSCP is now in an important transition moving towards the forefront of biological conservation science as it applies to complex landscapes that support a diverse flora and fauna.

## II. Summary of Review Comments

The review of the rare plants component of the monitoring program was conducted during 2005. We reviewed documents, made rare plant site visits with agency staff, compiled survey and monitoring results, entered and analyzed data, and held an October 2005 workshop with agency staff, consultants, and university scientists. Objectives were to thoroughly understand the efforts and results of the monitoring program thus far, so that we could provide informed feedback on program performance. Workshop notes are available at the City of San Diego MSCP web site (<http://www.sandiego.gov/mscp>). A follow-up workshop was held in February 2006 to discuss our preliminary recommendations with agency staff providing monitoring data, and to develop a monitoring and management protocol example for San Diego ambrosia.

Several major issues emerged in our review. These were evident from multiple sources, arising as concerns for the effectiveness and sustainability of the rare plants program over both the short- and long-term. These issues are listed in [table 1](#), and they are discussed in more detail in the following section as a series of comments and recommendations on each issue. Our recommendations for an adaptive management framework flow directly from these concerns. This framework preserves the strengths of the program, and provides new structure as the rare plants program moves into a phase of management and monitoring.

**Table 1.** Major issues emerging from MSCP rare plants monitoring program review.

---

Linking current population status to local and regional management needs
Ensuring that feedback and oversight mechanisms work in both local jurisdictions and regional agencies
Identifying appropriate types of monitoring: Status, trend, and effectiveness monitoring
Assessment of current trend monitoring data for detecting change
Developing a system for data archiving
Standardizing survey methodology
Verifying rare plant taxonomy with vouchered specimens

---

## III. Detailed Review with Recommendations

### Linking Current Population Status to Local and Regional Management for Conservation of the Species

Reviewers' Comment:

Knowledge of population status comes from several sources, including local expert knowledge, survey observations, monitoring results, and research by outside entities. There was a clear need to verify the presence and general condition of the rare plants on each parcel targeted for conservation when the MSCP was established. Surveys ([Appendix A](#)) have verified locations, sometimes even providing census information on plant numbers. Monitoring to detect trends in population size and area has been implemented at several sites ([Appendix A](#)), and management plans have been made for several of the larger land parcels (Natural Community Conservation Planning, 2005). These activities represent substantial tangible progress toward conservation plan implementation in the region, providing a foundation for further work.

## 6 San Diego Multiple Species Conservation Program (MSCP) Rare Plant Monitoring Review and Revision

The challenge before the MSCP now is to use the survey and monitoring information to develop Monitoring and Management Plans for each species that provide a road-map for management over the long-term, at both local jurisdictional and regional MSCP scales. Such conservation planning requires the development of an understanding of each species' ecology and the threats to its long-term persistence within the MSCP, via conceptual models and targeted studies, so that agencies can implement their management within a unified framework. This process has begun among some agencies. To expand on current efforts, the agencies should collaborate in a structured way to plan management with monitoring feedback that indicates whether the management is working or not. The jurisdictions should:

- standardize survey methods and share survey information;
- evaluate monitoring results to date;
- develop species profiles that compile and summarize ecology, threats, and conditions;
- develop taxon-specific short- and long-term conservation goals and objectives;
- prioritize populations for conservation;
- design monitoring that indicates the level of success of the local management treatments;
- agree on adjustments to management, monitoring, or population priority;
- ensure timely reporting of monitoring and management results; and
- participate in MSCP-wide evaluation of the effectiveness of their conservation management.

Thus far, the jurisdictions have generally developed their information bases and management plans individually. The common thread that binds most of the efforts are the reviews and recommendations by Ogden Environmental and Energy Services Co., Inc. (1996) and Conservation Biology Institute (2001), and the large and detailed base of expert knowledge developed in the consultant community and agency field staff in San Diego County. The most effective way to conserve the rare plants is to work within a regional context cognizant of the overall condition of the species. That way each jurisdiction's efforts contribute efficiently to conservation on the whole, in proportion to the ecological importance of their trust.

Several factors frustrate the further development of integrated conservation plan implementation in the region:

- uneven participation in the MSCP by the jurisdictions, so that there is incomplete knowledge of the condition of populations and habitats and uneven participation in regional conservation;
- uneven monitoring efforts by MSCP jurisdictions;

- lack of clear survey objectives, resulting in inconsistent information across the surveyed parcels;
- poor linkage of monitoring to management goals for the species or site;
- lack of a collaborative planning forum that takes advantage of the substantial local expert knowledge of species ecology and condition; and
- absence of a structured process for conservation implementation and evaluation.

This means that, while each jurisdiction strives to fulfill its requirements under the MSCP, each is doing so without the benefit of an overarching framework that allows each to contribute efficiently to implementation of the MSCP. Thus, the jurisdictions and oversight agencies cannot easily demonstrate or evaluate their contributions to the preservation of species ultimately required by the Natural Community Conservation Planning (NCCP) / Habitat Conservation Plan (HCP).

### Reviewers' Recommendation:

Develop a framework for regional collaboration that involves each jurisdiction and their experts equitably in conservation implementation, including monitoring. Within the framework, adjust rare plant monitoring programs so that monitoring is explicitly designed to answer management questions and assess management regimes and actions. Provide a structured means of communicating and evaluating progress, so that frequent adjustments can be made as more is learned through experience, and so that jurisdictions can effectively communicate their contributions to the MSCP.

## **Ensuring that Feedback and Oversight Mechanisms Work in Both Local Jurisdictions and Regional Agencies**

### Reviewers' Comment:

The MSCP is implemented by agencies with a variety of institutional structures, none of which accommodated a sustained plant monitoring program prior to its inception. Consequently, the MSCP functions have been inserted into institutional hierarchies that split planning, acquisition, survey and monitoring, and management into different program areas. In these cases, institutional mechanisms for information flow and feedback did not exist, and they have been developed ad hoc as the MSCP program has grown. Much of the communication has been developed from the bottom up, as staff most familiar with the taxa and land units seek common ground within and among their agencies. The result is that feedback from field observations to management staff is slow and incomplete. This situation makes conservation less efficient and effective than envisioned in the original plan.

Additionally, an oversight function unifying the entire MSCP under a regional perspective is missing. Although data are collected annually by the land management agencies, there is no central repository for the MSCP data and annual

reporting is poor. The State and Federal oversight agencies are distanced from Program implementation, with the result that program data are not archived annually and evaluated across jurisdictions.

Reviewers' Recommendation:

Formalize structured pathways within agencies for MSCP information exchange. Additionally, develop an oversight group within the adaptive management framework discussed above that ensures that the MSCP roles and responsibilities are fulfilled. This group would need to be made up of representatives of each subarea jurisdiction, the State and Federal agencies, and other stakeholders to ensure true collaboration. It would be a role of the group to hold annual peer reviews of monitoring and management efforts, enhance collaboration, provide expert assistance in monitoring, management, data analysis, and interpretation, make recommendations to improve conservation efforts, and develop a regional perspective on the effectiveness of MSCP rare plant conservation.

### **Appropriate Types of Monitoring: Status, Trend, and Effectiveness Monitoring**

Reviewers' Comment:

There is a subtle distinction between status and trend monitoring on the one hand, and effectiveness monitoring on the other. Both approaches use similar methods, such as counts in plots or abundance along transects. However, status and trend monitoring designs track change in population status, at some desired level of statistical confidence or power. Effectiveness monitoring links sample data to some management action as an explicit test of the effect on population status. Effectiveness monitoring is designed from the outset to show whether the management (or other aspects of the conservation strategy such as reserve network assembly) has the expected effect. This type of monitoring can have sample schema as simple as those used for status and trend monitoring or more complicated designs such as control-treatment or a before-after treatment design. As such, it is often thought of as "research" and is not therefore included in typical agency monitoring programs that need to be sustained over a long period of time. However, it is essential where land management is designed to produce a specific system response and for adaptive management.

The original MSCP rare plants monitoring program (Ogden Environmental and Energy Services Co., Inc., 1996) calls for status and trend monitoring to be sustained over a large number of years, with these expectations:

- Status monitoring will show whether a population exists or persists at a conserved site;
- Trend monitoring, the collection of annual or periodic abundance data, will show whether populations are increasing, stable, or declining;

- Periodic MSCP-wide data analysis will show whether a taxon remains conserved.
- If species are shown to be in decline, either through loss from local sites or through demonstration of a declining trend, appropriate management steps will be taken to reverse the decline.

The monitoring program was originally envisioned to include both status and trend monitoring, as appropriate to the local situation (Ogden Environmental and Energy Services Co., Inc., 1996); and the Conservation Biology Institute review (2001) sought to clarify ways to improve the statistical power of the sample design. However, monitoring to detect factors possibly linked to any trends was not made an explicit part of either program.

Status and trend data are collected at some locations within the MSCP, by a variety of methods. Appendix A summarizes the types of information collected by jurisdiction since 1999 for the covered rare plant taxa. Of the fifteen jurisdictions, four have conducted at least one-time surveys across a total of 193 sites to establish the presence, absence, or lack of detection of a taxon on protected lands. Fifty-six percent of those surveys also included some form of census data collection that showed numbers of plants, sometimes with estimates of the area occupied. Slightly more than half of these censuses have been repeated at least once, for an indication of persistence over time. Quantitative area- or transect-based trend data have been collected by the City of San Diego for seven taxa, by the USFWS refuges for three taxa, and by the County of San Diego for one taxon. This program fulfills a commitment to monitor. It does show that the areas set aside for conservation support the target plant species, and it indicates that with protection, these species continue to persist.

In some cases where the habitat appears large and free of threats, and there are large numbers of the target plant species, status checks may be sufficient to verify that conservation is working. In other more degraded sites, with more at-risk populations, additional data may be needed to ensure that management actions are appropriate and effective at preventing declines and promoting recovery. Implicit in the MSCP rare plants monitoring program design was the assumption that monitoring could indicate whether remedial action was needed. However, the status and trend monitoring as implemented cannot show whether that action was effective, because it is not designed as an assessment of correlated change related to management. Additionally, some agency staff feel that the monitoring program is disconnected from assessing or testing management actions that would insure the viability and persistence of each population.

Reviewers' Recommendation:

Some current effort on trend data collection could be redirected to effectiveness monitoring. In these cases, monitoring should be done to answer specific management questions, with immediate feedback that can be used to continue or change management practices. Thus, monitoring protocols should be developed with explicit reference to an hypothesis derived from a management need for information. Such monitoring might use the same or similar methods as those currently recommended, but the design objective should be on monitoring to show the effectiveness of conservation of the population or habitat.

This redirection would fulfill the monitoring mandate in a more meaningful way for management. Additionally, it would provide a more clear demonstration that the land management agencies are practicing the best management actions for conservation under the MSCP. Status monitoring could continue to provide the needed checks for persistence at the less at-risk sites, or at sites for which appropriate management techniques still need to be developed.

## Assessment of Current Trend Monitoring Data for Detecting Change

Reviewers' Comment:

Monitoring done to date covers 2–7 years, with the objective of documenting population status or trend. Sample designs vary across species, jurisdictions, and populations, but they follow the general guidelines in the Ogden Environmental and Energy Services Co., Inc. (1996) monitoring plan. We analyzed several long-term datasets provided by the City of San Diego MSCP rare plant monitoring program to assess their ability to detect change in the population. The specific assessments for San Diego ambrosia (*Ambrosia pumila*), variegated Dudleya (*Dudleya variegata*) and short-leaved Dudleya (*Dudleya blochmaniae* ssp. *brevifolia*) are presented in detail in [Appendix B](#). In summary, the datasets we analyzed could statistically detect between a 34 to 400 percent change in population abundance, with most datasets being inadequate to assess management effects or detect declines that might lead to the extirpation of the population. The general reasons for the poor ability to detect change are several:

- A highly variable (for example, clumped or gradient) spatial distribution of the individuals within populations or management units. The more highly variable the distribution of individuals in the population, the more difficult it is to obtain precise estimates of change. Highly variable data can be identified when sampling units contain many zeros (no individuals in the sampling units) or a wide range of counts. There are many ways to reduce this variability through an efficient sampling design.
- Inappropriate delineation of the target population, with sampling boundaries that included large areas with no or few individuals or highly variable numbers of individuals.

- A sampling method that does not adequately incorporate the dormancy/detectability of individuals, for example as seeds, rhizomes, or rootstocks.
- Inappropriate sampling unit size and shape. This one component of sampling design can influence the precision of the data and the detection of change.
- Low sample sizes. The larger the sample size, the better the precision of the data. But, larger sample sizes may also require more resources to sample. The objective of a sampling design is to obtain a balance between sample size and sampling efficiency.
- High environmental stochasticity. Year-to-year variations in precipitation and other environmental factors produce great variations in population responses. Such variation through time (stochasticity) requires large sample sizes and long assessment periods (perhaps decades) before trends emerge.

It was also noted that there are substantial non-sampling errors in the datasets. These are errors by the investigators and include non-random placement of sampling units, unrecorded sampling designs, unrecorded data, conflicting data for the same year, and lost data. An assumption of all statistical analyses is that non-sampling errors do not exist. Many of these errors result from loss of “institutional memory” within agencies, exacerbated by the lack of adequate metadata about sample design, locations, methods, and data handling.

Reviewers' Recommendation:

The following are general recommendations for future monitoring to detect changes in MSCP plant populations of concern.

- Develop individual conservation, monitoring, and adaptive management plans for each MSCP taxon that clearly state and explicitly document management objectives, monitoring methods, and analysis procedures.
- Using the current data and working with an ecologically oriented biostatistician (or skilled ecologist), redesign the monitoring of priority populations in accord with the monitoring and management plan.
- Redirect effort from the current status and trend monitoring to the appropriate status monitoring to assess the condition of populations and to more focused effectiveness monitoring designed to address questions of immediate management concern. A clear differentiation between these two types of monitoring will increase the understanding gained per resource invested. For status monitoring, sampling methods such as frequency and occupancy designs may be more quickly executed and more precise than current monitoring. For effectiveness monitoring, a clear objective will result in a more focused and efficient monitoring design.

- All monitoring data should be assessed during the year it is collected to insure precision and quality.
- Gather climate and other appropriate environmental data expected to be correlated with changes in populations. These correlations may provide significant biological insight into changes in population size and density.

## Developing a System for Data Archiving

### Reviewers' Comment:

Each jurisdiction is developing its own database for survey and monitoring data. Generally, survey data are in digital formats, using ArcView/ArcGIS shapefiles, MSAccess, and MSEXcel. Monitoring data are in many formats ranging from free-hand field notes to data recorded on forms to data in databases and spreadsheets. Metadata are poor, and notes on exact methods are in various formats. There is no place where the data for the entire MSCP are compiled, making regional collaboration and communication impossible.

### Reviewers' Recommendation:

The City of San Diego (2006) has recently compiled information on monitoring dates, field staff, and methods into one document; and the USFWS San Diego National Wildlife Refuge and the County of San Diego are drafting similar documents (John Martin, U.S. Fish and Wildlife Service, oral commun., 2006; and J. Buegge, County of San Diego, oral commun., 2006). This is the first step in developing metadata essential for each agency to track its program. The U.S. Geological Survey (USGS) has entered field data supplied by the agencies, bringing disparate paper files into digital formats. Each agency now needs to link metadata with the files, develop an internal system for filing and relocating data, and tracking progress. Better organization and capture of system memory would facilitate annual reporting for regional review and adaptive management.

The implementation of the regional framework discussed earlier, in which the subarea jurisdictions collaborate on issues common to all, should include the development and maintenance of a database reporting hub. Within this framework, it would be the responsibility of the management group to develop a scheme for annual collection and archival of rare plant data collected throughout the MSCP. Collection and compilation of information generated in the MSCP is essential for development of monitoring and management plans that guide conservation into the future.

## Standardizing Survey Methodology

### Reviewers' Comment:

Land typically has been surveyed for the presence of regionally sensitive plants soon after acquisition. Surveys have been state-of-the-art, using the best mapping techniques generally available. Mainly, the surveys have been conducted by local botanists with expert knowledge of the taxa, selected

from a list of locally certified botanists. Each jurisdiction is developing its own database with spatial and attribute data from the surveys. As a result, the survey data provide a basis for development of monitoring programs for recently acquired parcels within each jurisdiction. However, the surveys are conducted for various agencies, each with slightly different requirements. Consequently, they produce varying levels of detail in different data formats. This makes it difficult to compile a regional status database for evaluation of conservation options for any given taxon.

### Reviewers' Recommendation:

Develop MSCP-wide standards for field surveys and databases. Use the survey data to prioritize populations and species for conservation and monitoring (see Regan and others, 2006). Survey MSCP sites soon after acquisition to develop a baseline assessment of species status and habitat condition.

## Verifying Rare Plant Taxonomy with Vouchered Specimens

### Reviewers' Comment:

Taxonomic verification through collection of voucher specimens is not part of the existing system. As a result, population taxonomy is often unverified and undocumented. Such unverified situations can result in wasted resources if the taxa are misidentified. There are at least three reasons for the lack of specimens: (1) vouchering was not required under the original MSCP monitoring plan, (2) permits for collection of rare taxa are difficult to obtain, and (3) vouchering is seen as time consuming and thus not high priority for contractors or staff.

### Reviewers' Recommendation:

Streamline the permitting process. Develop voucher collections for all MSCP sites, including at a minimum the regionally sensitive species. Make vouchering part of the MSCP biological monitoring plan, with incidental take coverage under each agency permit authorized when voucher collection is performed pursuant to the Plan and to current San Diego Natural History Museum protocols ([Appendix C](#) or most current protocol).

## Summary of Review and Recommendations

Most of the major problems seen in the review of the MSCP rare plants monitoring program are related to a lack of program integration at the MSCP level, so that the roadmap for regional conservation is unclear. The result is that the monitoring program is developing in isolation, both within each subarea jurisdiction, and with respect to the real challenge of managing for regional conservation of populations. We recommend a shift to a framework that emphasizes the effective conservation of the MSCP covered plants, through integration of land protection and management with status and effectiveness monitoring.

## IV. Adaptive Management Framework for the MSCP

It is evident from this review that the current monitoring program for MSCP rare plants is not fully meeting its goal of providing local and regional feedback on program performance for conservation of the target species. Causes are related to institutional, logistical, scientific, and ecological constraints inherent in the implementation of such a large and far-reaching conservation program. Essentially, the MSCP seeks to conserve important populations of rare plants into the future. The program has had great success thus far, through land protection, management planning, and monitoring program development. For the rare plants program to be more effective from this point forward, land management and monitoring need to be explicitly related as complementary parts of a regional conservation framework, so management effects are clear and management can be adapted to improve the viability of the population. This is a challenge that is new to conservation as programs like the MSCP develop and mature across the United States, putting the MSCP at the forefront of conservation program implementation.

To meet this challenge, there needs to be a shift from solely status and trends monitoring to a program that combines status and effectiveness monitoring to evaluate progress (Sutter, 2006). This approach is more active and proactive, uniting threat abatement and land management with monitoring, for the ultimate purpose of conserving populations of target species. A key concept for the new program is adaptive management, a framework of active management and active learning. Here, we provide a discussion of the concept of adaptive management. Following this section we provide a specific rare plants program structure, based on the use of adaptive management for effective conservation of the San Diego MSCP covered plants.

### The Concept of Adaptive Management

Leading natural resource agencies have embraced the concept of adaptive management as their approach to managing species and ecosystems (Mulder and others, 2000; Atkinson and others, 2004; Pavlik and Espeland, 2005; and Sutter, 2006). Furthermore, adaptive management is mandated or encouraged by Federal and California laws governing the MSCP. Adaptive management recognizes the inherent complexity and uncertainty in managing natural resources and structures management into a learning process (Lee, 1993; Sutter, 2006). It is an iterative process of strategy, design, implementation, monitoring, evaluation, and adjusting management to maximize conservation success (figure 3). It evaluates decisions or actions through carefully designed monitoring and proposes subsequent modifications to management, threat abatement, and monitoring. The modifications are in turn tested with an appropriate, perhaps redesigned, monitoring protocol. At each turn of the cycle, active

learning through monitoring and evaluation reduces management uncertainty. Adaptive management is logical, can deal with uncertainty and data gaps, and is similar to the scientific process of hypothesis testing.

Adaptive management has developed from two sources (Sutter, 2006). The first is conservation biology's movement toward greater focus on biological diversity and ecosystem process at multiple spatial scales. This produces better understanding of ecosystem complexity, and reduces uncertainty in managing species. The other source is an outgrowth of the social and political controversy that surrounds management of natural resources; specifically, the failure to separate disagreements about objectives from the uncertainty of the science. Agreement on the management objectives is a prerequisite to good conservation. Adaptive management is the intersection of agreed upon objectives and uncertain science. It is the process of resolving scientific uncertainty through management (Lee, 1993; figure 4). It is important to note that not all management needs to be done within an adaptive management framework, but it works well for most cases.

### Implementing Adaptive Management

Envisioning the process of adaptive management as a cycle provides a useful structure for its implementation (figure 3). The first and most important task is to develop a strategy, or Monitoring and Management Plan, for the species. The strategy sets the vision for the species. It articulates the desired ecological conditions, overarching goals, and measurable objectives for each rare plant population and its habitat. It provides an assessment of factors that limit progress toward those goals and objectives. It clearly articulates the Key Management Questions (KMQ) (Pavlik and O'Leary, 2002) that structure all subsequent monitoring and research activities. It inventories known tools or actions for advancing the objectives (for example, reintroduction, mowing weeds, grazing). Once the strategy is developed, management, monitoring and research activities are designed as part of the Monitoring and Management Plan, along with criteria for evaluation and further implementation (figure 3).

Especially important are the KMQs that focus science on specific management issues and data gaps in order to realize the vision set out in the goals and objectives (figure 5). KMQs effectively constrict the tendency of purely scientific investigations to "widen," that is, to generate new hypotheses of interest but little relevance to actually "doing" management. So, the broad base of scientific inquiry (for example, geology, genetics, physiology, and ecology) is narrowed to a fine point by well-constructed KMQs (represented by the lower triangle in figure 5). Similarly, the broad base of management vision (for example, a native-rich coastal grassland with large numbers of San Diego ambrosia, the clones large and rapidly growing) is narrowed to another fine point by the same KMQs (the upper triangle in figure 5). Thus, KMQs bind the science and management vision together—no science is done unless it can be related to directly achieving specific goals and



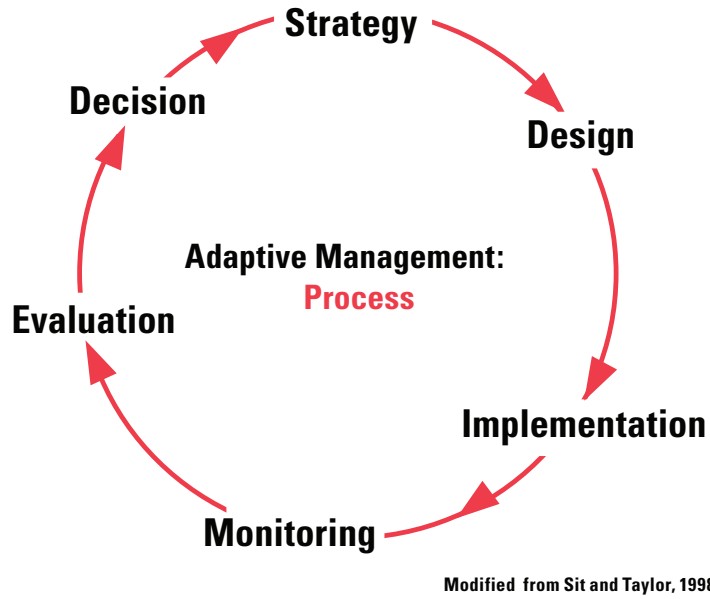

**Figure 3.** The process of adaptive management envisioned as a cycle.

**Controversy in Resource Management:**  
Negotiate objectives first, resolve uncertainty through management

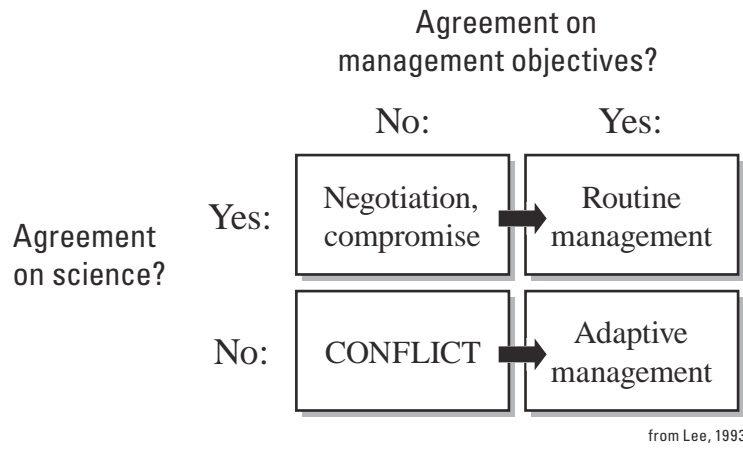

**Figure 4.** Controversy matrix in Resource Management.  
From Lee, 1993, page 106.

objectives of the program. An operating example of the critical role of KMQs in adaptive management is presented in Pavlik and O’Leary (2002) as a component of the program detailed in Pavlik and others (2002). These reports detail adaptive management for restoration of the rare, but federally unlisted plant (Tahoe yellowcress [*Rorippa subumbellata*]) that has been implemented on behalf of several State and Federal agencies in the Lake Tahoe Basin.

The successful implementation of adaptive management clearly requires a thoughtful approach to developing and implementing management plans, a well-designed process for monitoring the management effects, and an institutional structure that allows for active learning and adaptive action (Sutter, 2006). Typically, a team of land managers and scientists develops the Monitoring and Management Plan strategy and guides the process of management, monitoring, evaluation, and decision-making. This team must include cooperative and committed stakeholders, with a long-term interest in conservation of their rare species. Cooperation will ensure that (1) the planning partners’ efforts (and the data they generate) will be comparable if not similar; (2) successful actions (those demonstrated to be beneficial) will be widely and correctly applied (for example, to all populations of a taxon) and that rejected actions (those found to be detrimental) will be curtailed; and (3) emphasis will be placed on improvement of biological resources, not the generation of data.

## V. New Monitoring Framework and Methodologies

### A New Framework for MSCP Rare Plants Monitoring

We propose a new framework for the San Diego MSCP rare plants program, using the framework of effective conservation and adaptive management. This involves the development of new institutional structures, as well as the development and implementation of Monitoring and Management Plans that include scientifically rigorous monitoring protocols for each covered species. Specifically, we propose implementation of:

- Adaptive Management Working Group (AMWG): A team of land managers and scientists that guides the process of management, monitoring, evaluation, and decision-making. This team must be made of cooperative and committed stakeholders, with a long-term interest in conservation of their rare species.
- Technical Advisory Group (TAG): A subset of members of the AMWG that address tactical scientific problems associated with management, monitoring designs, and data analysis.

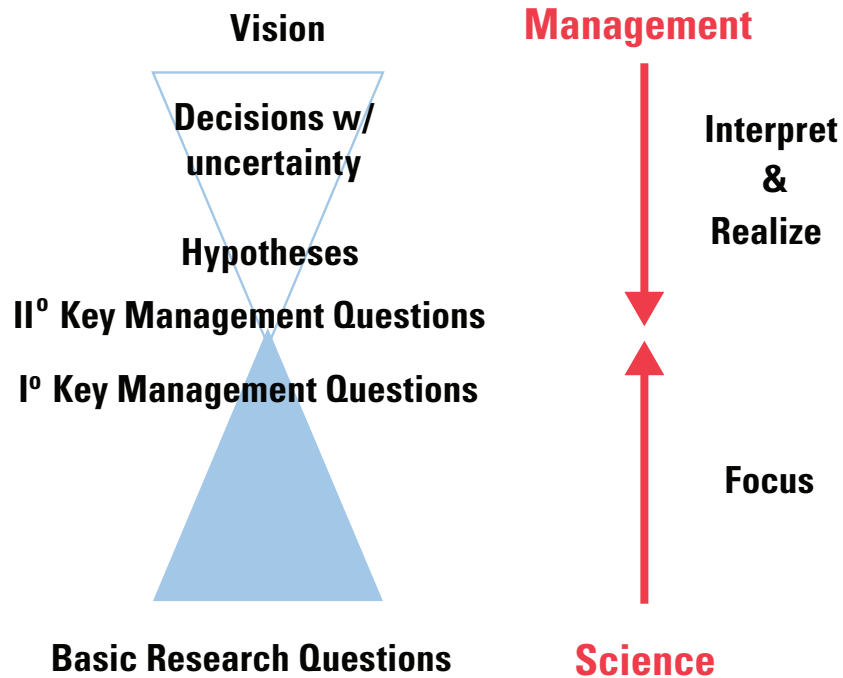

**Figure 5.** Key Management Questions (KMQs) help focus science to realize the management vision set by goals and objectives.

Secondary (II°) KMQs are specific enough to suggest testable hypotheses that directly inform management decisions (with inherent uncertainty). Based on Pavlik and O’Leary, 2002.

- **Structured Flow of Information:** A formalized strategy for information exchange that defines roles and responsibilities of team members as they work collaboratively.
- **A Monitoring and Management Plan for each covered species (including monitoring feedback):** A written plan that articulates the vision and implementation plan for a species' conservation in the MSCP (Appendix D).
- **Annual Program Review—Peer Presentations and External Review:** An annual meeting of agency staff and collaborators to present activities and results to one another, and peer reviewers.
- **Annual Assessment of Success:** A compilation of data, metadata, and reports on MSCP management and monitoring for the year and cumulatively across years.
- **Data Hub:** A central repository for the storage and dissemination of MSCP information, data, metadata, reports, and monitoring and management plans.

## Adaptive Management Working Group (AMWG)

Successful implementation of an effective conservation and adaptive management framework requires that committed stakeholders work together to plan and manage rare plant conservation in the MSCP. Our proposal is to form an AMWG (Pavlik and others, 2002) for the San Diego MSCP rare plant conservation program. Stakeholders in this group would be those responsible for and interested in the outcomes of decision-making and in the technical process of managing plant resources. They may include personnel from the MSCP jurisdictions, public agencies, private interests, and scientific organizations. It is the AMWG that develops Monitoring and Management Plans for each covered rare plant species. Thus, the AMWG would define and prioritize goals and objectives (see above), develop KMQs, recommend management actions, design and recommend necessary monitoring programs, and utilize monitoring data to evaluate progress. The AMWG is most likely to be effective if it consists of paid professionals that remain together as a team to frame conservation options for most, if not all, of the MSCP rare plants. Thus, the group would remain together as a team over the long-term, although they may call in local experts for information relevant to planning for specific taxa. One of their major institutional objectives would be to ensure that each jurisdiction retains autonomy, while contributing to the success of conservation at the regional level. The AMWG should be led by a chairperson, ideally with a science background, who understands the adaptive management process, is skilled at group leadership, and is familiar with the stakeholders and their unique (institutional) perspectives.

It is through the AMWG that adaptive management becomes a learning process imbedded within a regulatory and bureaucratic environment. This environment presents logistical, economic, and political constraints. It is a major responsibility of the AMWG to address these constraints.

Each stakeholder in the Group brings a unique perspective to the process, but all are ultimately focused on enhancing rare plant populations and habitat quality by cooperating in an open, non-adversarial forum. It is absolutely essential for the AMWG to cooperate on Monitoring and Management Plan development.

One of the first jobs of the AMWG should be the development and adoption of broad, visionary goals and objectives that speak to the desired ecological condition of each MSCP plant species. The Group should develop a multi-year schedule for Monitoring and Management Plan development soon after its formation. An example of a goals and objectives framework applied to restoration of rare plants is presented in Pavlik (1996). It is based upon efforts to develop success criteria for reintroduction projects and, therefore, is probably appropriate for some MSCP taxa. The listed objectives focus on demographic attributes, but they can be modified to include habitat attributes such as canopy cover, litter depth, or native species diversity.

Broad public support for the management and restoration of MSCP plants and habitats is necessary and desirable. Gaining that support requires a demonstration by the subarea jurisdictions that endangered species protection, habitat restoration, recreational access, and local governance can cooperatively work to protect the public trust. Part of the demonstration will come through concrete implementation of this management program by the AMWG. Another part will come through a public interpretation and education program that makes the resources, issues, and solutions real; that allows citizens to see these plants in a relatively intact natural landscape. Implementation of this program, along with an education and access program, could powerfully demonstrate that public agencies and resource advocates can find a way to make local governance work for the benefit of all.

## Technical Advisory Group (TAG)

A subset of the AMWG membership, known as the Technical Advisory Group (TAG), would convene to address tactical scientific problems associated with management, monitoring designs, and data analysis. The TAG should be led by a chairperson who understands ecological restoration, monitoring, and statistical approaches to project design and data collection. This person would likely be a different individual from the AMWG chair, with a greater focus on biostatistics. Like the AMWG, the TAG should remain together as a working group over the long term, to develop scientifically rigorous approaches to monitoring, data analysis, and management for all MSCP plants.

### Structured Flow of Information

There should be a structured flow of information between the AMWG and TAG, the public and the executives of associated government agencies (figure 6). Policy and political issues can be brought to the AMWG for discussion. If a technical solution is appropriate, the TAG is charged with its development using a science-based approach. Research and monitoring data can then be objectively reviewed and applied to the problem at hand. The results of the TAG deliberations are then taken back to the AMWG for review. This flow is designed to bring issues to the table, provide objective feedback from monitoring and research, develop science-based solutions, and ensure that management actions, funding efforts, and regulatory requirements have follow-up and timely implementation. Although conflict among stakeholders is inevitable (figure 4), structured information flow will help to resolve those conflicts and promote cooperation and institutional synergy over the long run.

### Monitoring and Management Plans for Each Covered Species

It is the role of the AMWG and TAG to develop Monitoring and Management Plans for each covered MSCP rare plant

species. Monitoring and Management Plan development is a rigorous process that sets the short and long-term strategy for a species' persistence across the entire MSCP. Therefore, the Plans must be made with input from the entire AMWG, and the group may include outside experts knowledgeable about the particular species. The Plans will have a hierarchical structure. They will include an overarching Plan for the species as a whole across the MSCP, as well as individual Plans for each of the population or management units conserved under the MSCP. The individual unit plans should combine to achieve the species-level goals and objectives. Each jurisdiction should draw its own management plans from these species and unit-level goals and objectives, to contribute to effective conservation across the MSCP region. Therefore, it is essential that all jurisdictional parties with management responsibility participate in the planning and conservation process for this approach to succeed.

Steps in Monitoring and Management Plan development are summarized in table 2; particular issues and concepts are defined and discussed in detail in this section. A questionnaire and template for Monitoring and Management Plan development for the MSCP is included in Appendix D. A draft Monitoring and Management Plan for one MSCP species, San Diego ambrosia (*Ambrosia pumila*) is included in Appendix E as a working example.

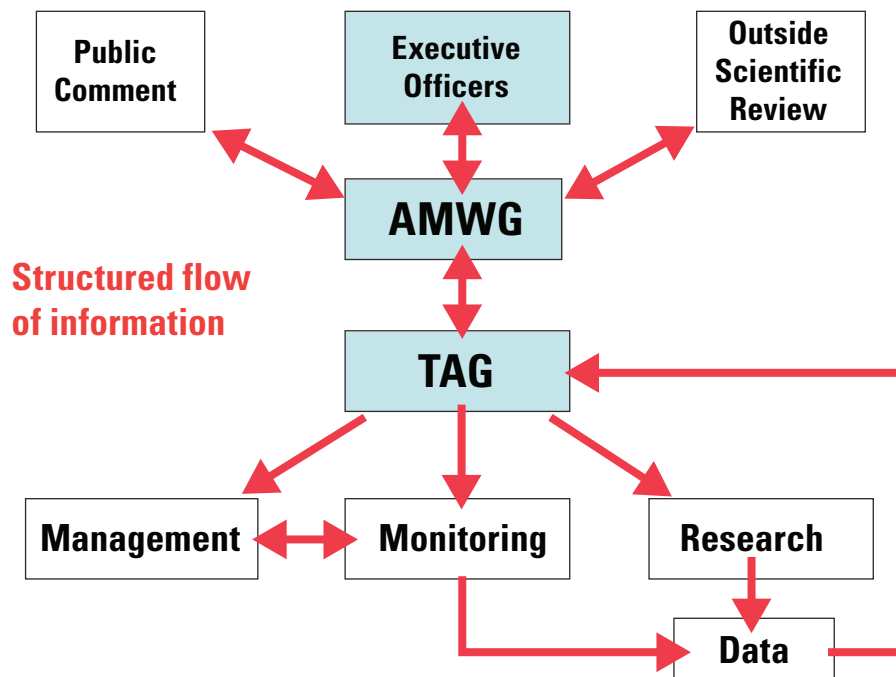

**Figure 6.** Information flow during adaptive management.

The member participants (green boxes) include the Adaptive Management Working Group (AMWG) and Technical Advisory Group (TAG). Executive officers of government agencies and other stakeholders get information through their representatives on the AMWG. The TAG directly oversees the activities of management, monitoring, and research which generate data for decision-making by the AMWG. Other inputs from the public and outside reviewers enter the flow through the AMWG. From Pavlik and others, 2002.

## Rare Plant Management Unit Definition

The properties (land parcels) that currently support populations of MSCP plants differ in many ways. Some are large (100 to 1,000 acres) and adjacent to other natural habitats, while some are small (101 acres) and surrounded by urbanized land. Some are very disturbed, with high cover by weedy grasses and forbs and scattered rare plants. Others are minimally disturbed, with high cover by native species and relatively large numbers and multiple clusters of rare plants. Some are easily accessible and often visited by the public, others are isolated and known only to a handful of experts. Structures, roads, and trails may be present. Management may or may not have taken place.

As a result of these biological and logistical differences, it is not practical to use whole properties as units for designing or implementing management actions. Instead, properties may support one or more “management units” (MU) separated from each other by intervening habitat, roads, or other fragmenting agents (Pavlik and others, 1998). Each MU is also delineated by the distribution and extent of the MSCP plant resources on each property for purposes of conducting a management action. The designation is based on practicality—not an assumption about whether it contains a distinct, rigorously defined “population,” “subpopulation,” or “metapopulation.” Therefore, a management unit has distinctive characteristics; including its own target resource (usually a cluster of rare plants of a particular taxon), its own scale, its own utility (as a site for an experiment, a treatment, or an observation), and its own fate (manipulated, unmanipulated, accidentally disturbed). Once management units have been designated for all MSCP taxa across all properties in the MSCP area, each can be categorized with respect to its utility in the adaptive management process. Each can have its own set of goals and objectives, determined by the AMWG, that will define its “desired future condition” and serve as indicators of management success. The individual management unit goals and objectives can be summarized at the park or agency level, for ease of park management planning; but each management unit ultimately needs to be evaluated on its own.

### Characteristics of Rare Plant Management Units

The resource at the center of each management unit (MU) is a Global Positioning System (GPS)-mapped “population” or cluster of individuals of a particular MSCP taxon. By examining an aerial photo with plant distributions accurately indicated, contiguous clusters of a taxon are arbitrarily grouped together into a single MU. Using such a photo for *Ambrosia pumila* at Mission Trails Regional Park (figure 8 in City of San Diego, 2006), it is easy to define four MUs: one large (the monitored occurrence), two small and one medium-sized that originated with a reintroduction effort. Not all occurrences of the species on the property need to be included. Conceptually, management units would be separated by 500 ft or more of intervening, unoccupied habitat that create barriers for population expansion. Roads, barrens, or built structures

provide even more separation by creating a heterogeneous disturbance regime across the property (e.g. influencing human access or acting as fire breaks). When this delineation process is repeated for all properties that support *A. pumila* across the south county area, a total of 11 MUs can be tallied, eight of which occur on MSCP preserved lands. Each of these eight MUs becomes part of a catalogue for a particular taxon available for categorization with respect to utility in the adaptive management process (see below). It is also possible that an MU could also be designated for a vegetation or habitat resource because of unusual species composition, landscape position or quality.

The size, and therefore, the scale of each management unit is defined by the extent of the target resource. Large units consisting of many individuals of a taxon could cover an acre or more while small units with few individuals could be a few square yards. The aforementioned separation of 500 ft between units should be typical but not absolute: intervention, especially by roads and barren areas, could reduce separation to a few hundred feet. To a great extent, therefore, the size and relative degree of isolation will determine its utility for management purposes.

### Rare Plant Management Unit Characterization

Without site-specific information, it will be nearly impossible to develop Monitoring and Management Plans for the MUs and the species in the MSCP. Therefore, each MU should be visited and carefully described at the beginning of the planning process. Attributes should be recorded on a standardized form (Appendix D), so that MUs can be compared, ranked, and fit into the overarching species Plan. Care should be taken to correctly identify the taxonomy of the target species, community dominants, and important weedy plants in the unit.

For example, the identification of *Dudleya variegata* (Variegated Dudleya), currently being monitored under MSCP based solely upon field observations in San Diego County, should be regarded with some skepticism because this species is very closely related to, and often confused with, *Dudleya multicaulis* (Many-Stemmed Dudleya). Both of these Dudleya species are native in San Diego County on heavy, clay soils near the coast, below an elevation of 600 m. These two species are small in growth habit with yellow, odorless flowers and spreading follicles, and have a corm-like underground stem. The main morphological characters used in differentiating these two species in the Hickman and others (1993) treatment are leaf shape and size. However, it should be noted that when these plants are in flower, which is usually the same time that they are being monitored because they are more easily seen in the field, they are mostly without leaves since they wither early and drop off. The only other distinguishing morphological character presented in the dichotomous key in Hickman and others (1993) for distinguishing these two Dudleya species is the length of petal fusion in the flowers (1–2 mm petal fusion for *D. multicaulis* and 0.5–1 mm fusion for *D. variegata*). Without careful attention to correct taxonomic verification, the wrong taxon might be targeted at the site.

Monitoring and Management Plan development

**Table 2.** Steps in Multiple Species Conservation Program (MSCP) rare plant Monitoring and Management Plan development.

<p><b>CHARACTERIZATION MODULE</b></p> <ul style="list-style-type: none"> <li>•Identify any additional Adaptive Management Working Group members for this species—experts who know the species, populations, and habitats.</li> <li>•Gather information on the species and populations (ecology, biology, maps, consult herbaria, identify jurisdictional responsibilities, experimental results for this and related taxa, past monitoring results, past management, MSCP priorities).</li> <li>•Identify the Management Units for the species:             <div style="border: 1px solid black; padding: 5px; margin: 10px 0;"> <p>A Management Unit is:                  A practical unit of land and biota that can be effectively managed as a whole.                  The management unit is a grouping of individuals on the landscape that is ecologically distinct and functions independently of other groups. The management unit is sometimes, but not necessarily, equivalent to a biological population.</p> </div> </li> <li>•Characterize each management unit, based on field observations of attributes such as the number of plants, proportion reproductive, size of area occupied, vegetation composition, apparent threats, landscape context, past management (see Appendix D for Management Unit Characterization Form).</li> <li>•Develop an ecological profile for the species using the background literature and expert knowledge; include uncertainties about life history or ecology that may need to be answered in order to develop conservation goals and management strategies.</li> </ul>
<p><b>MANAGEMENT PLANNING MODULE</b></p> <ul style="list-style-type: none"> <li>•Articulate desired ecological conditions and goals and objectives, for the species and for the management units; in terms of Abundance, Extent, Resilience, and Persistence, at both short and long time-frames.</li> <li>•Identify threats that may prevent or slow progress toward the desired ecological conditions.</li> <li>•Develop specific strategic conservation actions that address threat mitigation (through threat abatement and land management) and/or restoring the population (land and population management).</li> <li>•Clearly articulate the Key Management Questions at both the species and management unit levels.</li> <li>•Discuss management tools that may be effective in achieving the goals and objectives for each management unit.</li> <li>•Identify the phase of management envisioned for the management unit (Protection, Restoration and Recovery, or Preservation).</li> <li>•Determine what approach will be taken to management (Population Creation, Population Enhancement, or Maintenance of Habitat Quality).</li> <li>•Determine which management regime will be applied to the unit (Experimental, Guided, Intensive Care, or Quiescent).</li> <li>•Write a clear management action plan and schedule for the management units, relate to conservation goals for the species across the MSCP.</li> </ul>
<p><b>MONITORING DESIGN MODULE</b></p> <ul style="list-style-type: none"> <li>•Articulate the Key Management Question to be answered with the monitoring.</li> <li>•Identify the type of monitoring design appropriate to the situation (Status, Trend, Effectiveness, Validation).</li> <li>•Assess previous monitoring data and use it to better understand the taxon.</li> <li>•For effectiveness or validation monitoring, identify the sampling objective in terms of precision and power, time-frame, expected outcomes, response variables.</li> <li>•Develop a sample design, using the seven-step process described in the detailed review assessment of current data (section III).</li> <li>•Design the appropriate databases for monitoring data collection, storage, analyses, and progress reporting (include both qualitative or quantitative data and spatial databases, and metadata).</li> <li>•List the evaluation process for the monitoring outcomes, including the vision for next steps and adaptation of the Plan based on monitoring outcomes.</li> </ul>
<p><b>SCHEDULE AND BUDGET</b></p> <ul style="list-style-type: none"> <li>•Develop a schedule and budget for Monitoring and Management Plan implementation</li> </ul>

Other examples of taxonomic confusion with MSCP covered species in San Diego County also exist. For example, problems in differentiating *Ambrosia pumila* (San Diego Ambrosia) and *Ambrosia confertiflora* (Weak-Leaf Bur-Sage) in the Otay Valley area have led to various misidentified reports that occur in the California Natural Diversity Database.

The other part of effective characterization of MUs requiring taxonomic verification is correctly identifying and documenting the non-native, invasive plant species that are present and might be impacting a rare plant in a given Management Unit.

For example, one of the most diverse plant families in San Diego County also has an extremely high number of invasive species that are known to impact rare plants. The Poaceae (grass family) has 211 native or naturalized plant taxa in the County, of which 51 percent (107 taxa) are non-native to the region. (Note that “naturalized” refers to non-native plants that grow, persist, and reproduce in natural, non-cultivated habitats.) Two genera (*Bromus* and *Vulpia*) in the Poaceae have some species that are particularly invasive in areas, but have other species that are native to the county. For instance, the genus *Bromus* (chess/brome grasses) has 15 native or naturalized grass taxa occurring in natural areas in San Diego County, of which 4 are native species to the County. Also, the genus *Vulpia* (fescue grasses) has nine taxa that are native or naturalized in the County, but 3 are non-native taxa and are invasive. Because different species in the same genus may impact rare plants in different ways, and because there are native and non-native species in these genera present in the County, it is essential to know exactly which species are present in a given MU. Furthermore, due to the abundance (both taxonomically and spatially) of these species, it is possible that different species in a given grass genus may be present in different MUs for the same rare plant taxon. Thus, without proper voucher specimen documentation, the presence or correct identity of these taxa may always be in doubt.

### Goals and Objectives for Rare Plant Management Units

The AMWG would first delineate all MUs for a taxon, characterize each one, and develop a set of goals and objectives for each using a standard framework. Such a framework has already been suggested by studies of reintroduced and managed populations of rare plants (Pavlik, 1996). Generic goals are adapted from ecological paradigms that stress the importance of plant establishment, growth, reproductive output, the number and size of populations, resistance to perturbation, and occupation of multiple microhabitats. The four goals that best reflect these paradigms are Abundance (greater numbers of individuals is better), Extent (more area and more populations is better), Resilience (the ability to recover from

disturbance or uncertain conditions is better), and Persistence (the ability to maintain a presence through time is better).

With respect to a given MU, taxon-specific objectives that meet the goals of abundance, extent, resilience, and persistence are explicitly stated by the AMWG. The objectives are simple statements of “desired ecological conditions,” both near-term and long-term, that set performance benchmarks for management actions and the responses of the target resource. These objectives should be measurable, and relate directly back to the goals. They include attributes of size/spatial extent, demographic condition, biotic condition (community/habitat), abiotic condition (ecological processes, soil, etc.), and landscape context. Clear articulation of measurable objectives are the necessary precursor to monitoring protocol development. As such, they are the only way “success” and “failure” can be decisively ascertained through monitoring (Pavlik, 1996).

An example of a long-term abundance objective for a particular rare taxon in one MU could be “achieve a temporal mean of 1,000 above-ground individuals for ten years under the current management regime.” An example of a near-term extent objective could be “observe the establishment of a new cluster of individuals just beyond the known borders of the MU after three years of weed control.” Such statements can be revised as data gaps are filled or as management prescriptions are tested. But ultimately, success in managing biological resources in general and MUs containing rare plants specifically, is defined as meeting taxon-specific objectives that fulfill the goals of abundance, extent, resilience, and persistence. In effect, success is an argument to be made with support from monitoring programs that measure progress towards each robust objective.

### Rare Plant Management Regimes

We suggest that all MUs be assigned one of four utility categories or management regimes: Guided, Experimental, Intensive Care, or Quiescent. An MU assigned to the “Guided” category would have a mid-sized cluster of an MSCP taxon (perhaps 100 to 1,000 above-ground individuals), relatively protected from human disturbance, which would benefit from applying a proven management prescription. That prescription could come from what has been learned at an experimental MU, or it could come from the experience of hands-on managers. In either case, the effective management action (for example, raking to remove grass thatch) does not require any more scientific scrutiny. It does, however, require an effectiveness monitoring program to confirm the positive response of the target resource and its habitat. The purpose of a guided MU would be to maintain or improve the target resource using the best available management practice (BMP) and to provide feedback to the adaptive management process.

An MU assigned to the “Experimental” category would at present support a relatively extensive, large (for example, 1,000 to 10,000 above-ground individuals) and perhaps stable “population” of a rare taxon. Ideally, it would also be spatially separated from other MUs, be at a distance from heavily visited recreational areas yet have easy access by means of a road or short trail. This would allow for the testing of effects of a management treatment (for example, weeding, controlled burns) without impacting a large proportion of the above-ground individuals of the target taxon. The purpose of an experimental MU is to provide a system for generating taxon-specific (rather than site-specific) information to increase the abundance and distribution of MSCP species. It would be used to fill information gaps identified in the adaptive management process. The results, generated by either an effectiveness or validation monitoring program (depending on the design of the experiment) would be used to develop taxon-specific management prescriptions for application in other, non-experimental, management units.

An MU assigned to the “Intensive Care” category would be small (10 to 100 individuals) and obviously threatened by human disturbance (for example, bisected by a popular trail). It requires immediate action to ameliorate threats, even if no proven management prescription is known for that taxon. For MSCP taxa assigned to Intensive Care MUs, the bottom-line goal would be to prevent extirpation of the seed (or meristem) bank. Fencing to reduce trampling or hand weeding to enhance growth and reproduction of target plants, are reasonable actions to take for purposes of intensive care. With few target plants, a yearly census would be sufficient to track responses and trends. Volunteers who erect fences, weed, or count plants must be very careful not to compound problems in the MU by limiting their own impacts (for example, accidental trampling, soil compaction).

Finally, an MU assigned to the “Quiescent” category is to be left alone in the near term. It is likely to be small in extent, have a small to moderate “population” (10 to 1,000), but is isolated from obvious threats and appears to be relatively stable. Owing to a lack of access, management is impractical and probably unnecessary at the present time. Like any MU, it could be assigned a different category in the future, depending on the development of management prescriptions and changing conditions on this or other sites (for example, the occurrence of a fire). Monitoring there is likely to be status monitoring.

## Types of Monitoring Design

Monitoring is the only way of evaluating the success of management actions and is the key learning component of adaptive management. It is designed and implemented with the expressed purpose of determining if the objectives of the

adaptive management strategy [figure 3](#) are being met. The AMWG should build monitoring into evaluation of every management action and targeted study effort.

Some basic elements of monitoring are universal: consistency (repeatable methods applied each year), constancy (applied at regular time intervals), and appropriateness (for the target resource). Such design elements are essential for evaluating actions and research efforts, as well as revealing the status of the focal resource (in this case, populations of MSCP taxa).

Monitoring is used to detect changes in spatial extent and occupancy, abundance and density, and demographics of a population. We recognize three types of monitoring, each with a specific purpose (Sutter, 2006): (1) Effectiveness monitoring, (2) Validation monitoring, and (3) Status monitoring.

Effectiveness monitoring assesses the effects of management actions, and is the type of monitoring that is the companion to adaptive management. Using the appropriate sampling design; it tells the manager if a given attempt at improving the performance of a plant population or the quality of a habitat has been successful. Thus, effectiveness monitoring is used to test management hypotheses with field experiments, usually carried out by land managers under the guidance of technical experts. With respect to the MSCP, it is also applied to the development of management tools for specific taxa by measuring the effects of relevant variables (for example, controlled burns, herbicide applications) on demographic processes (germination, establishment, growth, reproduction, mortality). This type of monitoring would be designed by science-trained members of the TAG, with input from land managers that would ultimately perform the treatments.

Validation monitoring assesses the results of management experiments that test a management technique or method over a part of a population or management unit, with a rigorous and hypothesis-based sample design. It follows the recommendation of adaptive management to minimize risk to the species (thus only part of the population is tested for a management regime as a pilot study) and is structured to determine the viability of future management at the population or management unit scale. Validation monitoring may utilize management treatments, but with a rigorous design it attempts to establish a stronger inference of ecological cause and effect. Validation monitoring is used to fill very specific data gaps that have been identified and prioritized by the AMWG. It is very specialized, and can be time-consuming and relatively expensive. Consequently, this type of research-oriented monitoring should be designed by the TAG in consultation with experts who would ultimately conduct the investigation. The data thus generated would be used by the AMWG to develop new management recommendations based upon an improved understanding of the target resource.



Lastly, status and trend monitoring assesses the current condition of a population or management unit without an active management component. It is recommended that status monitoring be implemented when populations and habitats are thought to be secure without management or in situations when the knowledge base or agency capacity for management is lacking. Status and trend monitoring could involve assessments of habitat characteristics, such as threats, or changes in habitat quality. In all cases, status monitoring should be structured to learn about management needs and opportunities. In the MSCP, status monitoring might be applied to populations and habitats managed with a quiescent regime, as a check on their condition.

The principles and techniques of effectiveness, validation, and status monitoring are given in Taylor and Gerrodette, 1993; Pavlik, 1994; Elzinga and others, 1998; Thompson and others, 1998; Elzinga and others, 2001; Feinsinger, 2001; and Sutter, 2006.

## Sampling Design

An essential component of population monitoring is the sampling design used to detect the effect of management or the change in status in populations of concern. The goal of a sampling design is to obtain a level of data precision that allows the efficient (in resources) and repeatable (over time and investigators) detection of change. There are seven primary decisions that are part of developing a sampling design for a population, species, or habitat (Sutter, 2006). These are:

- Understanding the biology/ecology of the species or ecological system and how it influences sampling and detecting change.
- Identifying the target population, for example, the extent of the population to which the biological and statistical inferences from the monitoring data will be made.
- Selecting the appropriate sampling unit and sampling unit size and shape.
- Positioning of the sampling unit in the target population.
- Selecting the temporal duration of the sampling unit (for example, are the sampling units permanent or temporary?)
- Determining the number of sampling units needed to meet a specified level of precision.
- Selecting an appropriate frequency of sampling.

## Annual Program Review: Peer Presentations and External Review

For the MSCP rare plants program to be effective, there must be annual review of the management actions taken, and the monitoring data and conclusions. The review needs to be done at several levels, in an annual workshop involving stakeholders, land management agency staff, scientists, and oversight agencies. The workshop should involve:

- Peer-presentations by staff, scientists, and consultants on management and monitoring conducted that year;
- TAG evaluations of monitoring results for each management unit;
- Recommendations on upcoming management and monitoring from the AMWG, based on the peer presentations and TAG evaluations;
- Oversight agency participation in MSCP adaptations for the coming year.

It would be logical for these reviews to be conducted in the late fall of the year, soon after the growing season ends and data can be analyzed for the majority of the covered species. Additional external review may be requested for certain management, monitoring, or research protocols, or for adaptive management recommendations.

## Annual Assessment of Success

Since an essential part of the rare plant conservation program is public outreach and stakeholder education, there should be an annual summary assessment of Plan results, things learned and implications for future conservation, building from the annual MSCP workshop. This summary should be made by the AMWG as part of their outreach function and their responsibilities to the data hub (see below).

## A Regional Data Hub for Monitoring

Restoring biological diversity in San Diego County requires the coordinated efforts of many stakeholders operating within an adaptive management framework. That framework, with its imbedded monitoring programs for all MSCP elements, will generate large amounts of taxon-specific and habitat-specific data over long periods of time. Those data will include the results of management experiments, effectiveness monitoring, photo-monitoring, and spatially explicit mapping studies. When standardized in terms of design and format, the data will provide immediate feedback to the current adaptive management process. Every management unit for each taxon will have its own history of manipulation, its own monitoring dataset, and its own set of goals and objectives that define its future desired condition. The challenge will be to archive this diverse and abundant information for use by subsequent

generations of managers and restorationists. Those generations will only benefit from our efforts if they can evaluate, replicate, or repudiate the methods and biological outcomes. To spare them from duplicating mistakes, we must build a standardized project registry and a centralized data repository to serve as a “hub” for restoration and adaptive management efforts in the MSCP. The hub will be a regional, go-to center for agencies, consultants, research institutions, and other practitioners seeking a record of past success and failure.

The idea of a central repository for restoration data is not new. Journals provide a published repository, but only for a very small fraction of the total restoration projects performed. The work of consulting firms, government agencies, and other non-academic groups, such as the California Native Plant Society, seldom finds its way into the published literature. Project reports and environmental impact documents contain much valuable information, but much of this “gray literature” is soon lost from our libraries, agency archives, and collective experience. The California Department of Fish and Game is developing a biogeographic database (BIOS) to archive biodiversity information, but not information generated by management, restoration, or recovery projects at the level of the MSCP. Professional societies, such as SERCAL (California Society for Ecological Restoration), maintain statewide databases for large-scale restoration projects. The problem is that most large projects do not involve rare species. There are also many small, regional restoration projects that will never be submitted to those databases. These regional projects, often dealing with local or rare species and communities, may be the richest and the most underutilized source of information for effective management and restoration.

We recommend construction of a Geographic Information System (GIS)-referenced registry and database that supports the MSCP adaptive management process, across conservation projects of all sizes and levels of complexity in the MSCP. Any action taken within an MSCP management unit would be tracked. A simple, one-page tracking form, with information on the species, location, contact, and type of management could be submitted to the “hub” by project proponents (AMWG, park managers or volunteers, researchers, school classes, consultants) before work is initiated. Agencies that permit or facilitate such work should require submission of the form when giving their permission or paying for rendered services. Projects could be classified using a few general categories (for example, monitoring, population enhancement, habitat enhancement, habitat type, and target species) and geographically defined using GPS coordinates. Precise description and locality information will allow future evaluation of the project.

If a tracked project will generate monitoring data, the “hub” could assist in the design of datasheets and measurements. This will insure that the data can be easily archived in the database. With respect to MSCP projects, the TAG could develop standard data and database formats.

Future use of the registry and database will be enhanced by site-specific (mapped), taxon-specific and habitat-specific

referencing. With GIS, simply pointing to a location on the county map would generate a taxon management or restoration project history in a 5-mile radius and a restoration history for habitat (vegetation) types present on the site of current interest. This will facilitate dissemination of regional restoration knowledge and long-term evaluation of finished projects and the methods they employed.

Ultimately, this registry and database should be harbored by an institution that can promote a full exchange between ecological theory and practice (Pavlik, 1997, 2004). The home, or “hub” as described above, is beyond the boundaries of existing universities and government agencies because it must, in the end, produce a very tangible result: restored or simulated natural communities. Those communities will have desirable ecosystem characteristics that are self-sustaining and of high enough quality to provide habitat for wildlife and endangered species of all sorts.

Towards this end, the proposed hub (project registry and database) for the MSCP could be regarded as the first essential step towards establishing a regional center for ecological restoration. The hub is at the center of three major constituents: decision-makers, information generators, and regulators. The decision-makers include the MSCP adaptive management working group and any other resource management group that deals with restoration in or around San Diego County. They could come to the hub to learn what management tools, prescriptions, or data have been already been developed. They could also locate local examples of restoration projects that have been installed in the past, perhaps for a new evaluation of whether success was achieved. The information generators include university researchers, private consultants, and land managers who test hypotheses, practice restoration, or monitor the results of their own management efforts. They come to the hub to archive their projects, monitoring data, reports, and experiments, thus filling gaps in the understanding of resources and restoration. The regulators include federal, state, and local agencies that issue permits, require mitigation, seek compliance, and in general act on behalf of the public interest. They come to the hub to follow-up on compliance, obtain the best mitigation alternatives, and learn the limits of local restoration and management efforts. Without a hub the progress of resource management is lost by poor communication, forgotten projects, and an inability to learn from success and failure.

If established and carefully administered, the MSCP hub could provide an institutional “home” that supports the management of many characteristic species and ecosystems of the region. Knowledge about MSCP species, dominant native species, and important natural communities could be stored, amplified, and disseminated. It could be a model for other such centers across the state. As such, the network could provide practical solutions for solving restoration problems faced by industry, government, and conservation organizations. The center would provide a service to landowners and resource managers that promotes restoration technology in the same way that Cooperative Extension at the University of California has promoted productivity and efficiency for agriculture.

## Summary of New Framework and Methodologies

In summary, this framework provides monitoring to address "key management questions," with feedback mechanisms ensuring effective conservation. It presents the framework for a program accommodating change in management and monitoring

- as management progresses,
- as data are analyzed,
- as the landscape context changes (for example, succession, decreasing parcel size),
- as taxa respond to changes in external pressures (for example, drought, fire).

It proposes a program that effectively accumulates, archives, and shares data. It is a program with annual internal peer review and external oversight that ensures the program remains responsive to changing conditions and new information in conservation biology.

## VI. Recommended Implementation Schedule and Benchmarks

**Table 3.** Recommended rare plant adaptive management implementation schedule

Implementation item	Timeframe (from report adoption)
Establishment of Adaptive Management Working Group (AMWG) and Technical Advisory Group (TAG)	One year
Develop schedule/timeline for development of Monitoring and Management Plans for all covered species	One year
Pilot Adaptive Management Monitoring and Management Plans implemented for three species	Two years
Initial baseline evaluation for all management units	Two years
Establishment of data hub	Three years
Completion and implementation of Monitoring and Management Plans for all monitored species	Five to Seven Years

## VII. Conclusions

The San Diego MSCP is on the leading edge of conservation, in one of the most rapidly developing urban areas in the nation. It has thus far been very successful at acquiring conservation lands to protect habitats and rare species. The program is in transition now, from one focused on planning and protection to one of management and monitoring. Survey information provides basic knowledge of species presence and absence in MSCP conservation areas. Several multi-year datasets exist, sampled to show trends in particular populations. However, this trend monitoring has low statistical power for inferring trends, largely because of high spatial and temporal variability in the monitored populations. Monitoring for trends at an acceptable level of statistical confidence requires effort far beyond the scope of limited staff time and agency budgets. Additionally, the program needs greater focus on monitoring that is clearly related to management, so that the effects of management on species and their habitats can be determined. The program currently suffers from a lack of regional vision and structure, thus regional planning and synthesis is lacking.

Redirecting the current effort planned for trend monitoring to a program of adaptive management planning, monitoring, evaluation, and implementation will give the program greater focus on conservation goals. Local jurisdictions should be involved in the development of regional conservation plans for each covered species, to ensure that their management contributes to overall species persistence in the MSCP area. An adaptive management framework for rare plant conservation would allow agencies to collaborate on plans and management, using monitoring as a collective tool providing feedback for improved management. Development of an MSCP-wide adaptive management team and a regional data hub will facilitate regional synthesis for more effective conservation. This program is a world-class example for conservation, uncharted territories for most agencies. It has all of the components for success as it moves forward into a new phase of conservation management.

## VIII. Acknowledgments

We would like to thank the staff of the agency MSCP programs for their assistance in this review, and the interested members of the larger San Diego conservation community that attended the March 2005 and 2006 public workshops for their input and feedback. Particularly, scientists from the City of San Diego, San Diego County, the San Diego National Wildlife Refuge, the USFWS Carlsbad Field Office, and the California Department of Fish and Game arranged workshops, provided data, took us to numerous field sites, discussed monitoring program design and implementation, shared information and insights at the October 2005 workshop, and provided feedback on early drafts of this document. Jerre Stalcup and Tom Oberbauer provided invaluable background on MSCP rare plant program development. Jeremy Buegge, Keith Greer, Lauren Heirl, Melanie Johnson, and John Martin assisted in development of the example *Ambrosia pumila* conservation plan, and Elizabeth Friar, Mitch McGlaughlin, and Gary Wallace provided valuable reviews of that plan. Trish Smith, and John Willoughby gave us excellent reviews of the final review document.

## IX. Literature Cited

- Atkinson, A.J., Trenham, P.C., Fisher, R. N., Hathaway, S.A., Johnson, B.S., Torres, S.G., and Moore, Y.C., 2004, Designing monitoring programs in an adaptive management context for regional Multiple Species Conservation Plans: U.S. Geological Survey, California Department of Fish and Game, and U.S. Fish and Wildlife Service, 69 p.
- California Department of Fish and Game, 1991, Natural Community Conservation Planning Act: Sacramento, California, California Fish and Game Code Section 2800–2835.
- California Native Plant Society, 2006, Inventory of rare and endangered plants. Accessed 01/2006. <http://www.cnpsdd.org/ambrosia99.html>
- City of San Diego, 2000, Summary of monitoring results for *ambrosia pumila*: San Diego, California.
- City of San Diego, 2001, Summary of monitoring results for *ambrosia pumila*: San Diego, California.
- City of San Diego, 2003, Summary of monitoring results for *ambrosia pumila*: San Diego, California.
- City of San Diego, 2005, City of San Diego rare plant monitoring: Field monitoring methods: San Diego, California.
- City of San Diego, 2006, Rare plant monitoring—Field monitoring methods: San Diego, California, Planning Department, Multiple Species Conservation Program Division, 60 p.
- County of San Diego Multiple Species Conservation Program, 2002, Sensitive plant monitoring final Report: Prepared for California Department of Fish and Game.
- Conservation Biology Institute, 2001, Status summary of biological monitoring plans for the Multiple Species Conservation Program (MSCP): San Diego, California, Technical report prepared for City of San Diego and California Dept. of Fish and Game, 40 p.
- Dudek & Associates, 2000, City of San Diego Mission Trails Regional Park San Diego *Ambrosia* Management Plan: Prepared for City of San Diego, California.
- Elzinga, C.L., Salzer, D.W., and Willoughby, J.W., 1998, Measuring and monitoring plant populations: Denver, Colorado, Technical Reference 1730-1, Bureau of Land Management, 477 p.
- Elzinga, C.L., Salzer, D.W., Willoughby, J.W., and Gibbs, J.P., 2001, Monitoring plant and animal populations: Malden, Massachusetts, Blackwell Science, Inc., 360 p.,
- Feinsinger, P., 2001, Designing field studies for biodiversity conservation: Washington, D.C., Island Press, 212 p.
- Friar, E., 2005, Conservation genetics as a tool for scientists and managers: Fullerton, California, Presentation at 2005 Southern California Botanists Symposium.
- Hickman, J.C., ed., 1993, The Jepson manual higher plants of California: Berkeley and Los Angeles, California, University of California Press, 1400 p.
- Griffin, D.J., 2003, DRAFT 2003 Report of MSCP covered species at San Diego National Wildlife Refuge: Prepared for U.S. Fish and Wildlife Service, Carlsbad, California.
- Lee, K.N., 1993, Compass and Gyroscope—Integrating science and politics for the environment: Washington, D.C., Island Press, 239 p. (p. 106).
- McGlaughlin, M.E., and Friar, E.A., 2006, Clonality in the endangered *Ambrosia pumila* (Asteraceae) inferred from RAPD markers; implications for conservation and management: Conservation Genetics DOI 10.1007/s10592-006-9171-4. 12 p.
- McMillan Biological Consulting, and Conservation Biology Institute, 2002, 2001 MSCP Rare Plant Survey and Monitoring Report: Prepared for the City of San Diego, California.
- Mulder, B., Noon, B.R., Pavlik, B.M., and Scott, J.M., 2000, Monitoring and adaptive management for endangered species: Shepardstown, West Virginia, U.S. Fish and Wildlife Service, National Conservation Training Center Course EC3134.

- Natural Community Conservation Planning, 2005, Status of NCCP planning efforts: Natural Community Conservation Planning, California Department of Fish and Game. [http://www.dfg.ca.gov/nccp/MSCP/mscp\\_home.htm](http://www.dfg.ca.gov/nccp/MSCP/mscp_home.htm)
- Ogden Environmental and Energy Services Co., Inc., 1996, Biological Monitoring Plan for the Multiple Species Conservation Program: Carlsbad, California, Technical Report prepared for City of San Diego, California Department of Fish and Game, and U.S. Fish and Wildlife Service.
- Pavlik, B.M., 1994, Demographic monitoring and the recovery of endangered plants, *in* Bowles, M.C., and Whelan, C. (eds.), *Recovery and restoration of endangered species*: Cambridge, Massachusetts, Cambridge University Press, p. 322–350.
- Pavlik, B.M., 1996, A framework for defining and measuring success during reintroductions of endangered plants, *in* Falk, D., Millar, C., and Olwell, P. (eds.), *Restoring diversity—Strategies for reintroduction of endangered plants*: Washington, D.C., Island Press, p. 127–156.
- Pavlik, B.M., 1997, Approaches, techniques and institutions for conserving rare plants: *Southwest Naturalist*, v. 4, p. 375–383.
- Pavlik, B.M., Smith, A., and Miller, A., 1998, Development of the Santa Rosa Vernal Reserve System. I. Property inventory, database construction and short-term management regimes for ecological restoration: California Department of Fish and Game, Plant Conservation Program, 102 p.
- Pavlik, B.M., and O’Leary, A.N., 2002, Implementation of the Conservation Strategy for Tahoe Yellow Cress (*Rorippa subumbellata*). II. Key Management Questions as a Framework for Research: Lake Tahoe, Nevada, Tahoe Regional Planning Agency, 24 p.
- Pavlik, B.M., Murphy, D.D., and the Tahoe Yellow Cress Technical Advisory Group, 2002, Conservation Strategy for Tahoe Yellow Cress (*Rorippa subumbellata*): Lake Tahoe, Nevada, Tahoe Regional Planning Agency.
- Pavlik, B.M., 2004, Looking ahead—Rare plant conservation in California, *in* Brooks, M.B., Carothers, S.K., and LaBanca, T. (eds.), *The ecology and management of rare plants of northwest California*: Sacramento, California, California Native Plant Society, 226 p.
- Pavlik, B.M., and Espeland, E.K., 2005, A management program for Santa Cruz Tarplant (*Holocarpha macradenia*) at Arana Gulch: City of Santa Cruz, California, Department of Parks and Recreation, 98 p.
- Regan, Helen, Lauren Hierl, Janet Franklin, Doug Deutschman, 2006, Grouping and prioritizing the MSCP covered species: San Diego State University, San Diego, California, Technical report to California Department of Fish and Game.
- Reiser, C.H., 1994, Rare plants of San Diego County: San Diego, California, Aquafir Press, Unpublished. Available online at: <http://sandiego.sierraclub.org/rareplants/008.html>
- Ross, T.S., 1996, Herbarium specimens as documents: Purposes and general collecting techniques: *Crossosoma*, v. 22, p. 3–39.
- Simpson, M.G., 1997, Plant Collecting and documentation field notebook: San Diego, California, San Diego State University Herbarium Press.
- Sit, V., and Taylor, B. (eds.), 1998, *Statistical methods for adaptive management studies*: Vancouver, B.C., British Columbia Ministry of Forests, 157 p.
- Soil Ecology Restoration Group (Johnson, J., D. Bainbridge, J. Janssen, and D. Truesdale), 1999, *Ambrosia pumila*: monitoring, outplanting and salvage. <http://www.serg.sdsu.edu/SERG/restorationproj/chaparral/ambrosia.html>
- Sutter, R., 2006, *Lectures in effective conservation and adaptive management*: Durham, North Carolina, The Nature Conservancy.
- Taylor, B.L., and Gerrodette, T., 1993, The uses of statistical power in conservation biology—The Vaquita and Northern Spotted Owl: *Conservation Biology*, v. 7, p. 489–500.
- Thompson, W.L., White, G.C., and Gowan, C., 1998, *Monitoring vertebrate populations*: San Diego, California, Academic Press, Appendices.
- U.S. Fish and Wildlife Service, 2000, Endangered and threatened wildlife and plants; Reopening of comment period on proposed endangered status for *Ambrosia pumila* (San Diego Ambrosia): *Federal Register*, v. 65, no. 62, 16869–16870.
- U.S. Fish and Wildlife Service, 2002, Determination of endangered status for *Ambrosia pumila* (San Diego ambrosia) from southern California: *Federal Register*, v. 67, no. 127, 44372–44382.
- U.S. Fish and Wildlife Service, 2006, Draft *Ambrosia pumila* technical report: Jamul, California, San Diego National Wildlife Refuge.

This page intentionally left blank.

# Appendixes

**Appendix A. San Diego Multiple Species Conservation Program covered rare plants: Summary of surveys and monitoring across jurisdictions.**

[**Priority table 5-1 and SDSU:** Priority rank redesigns from Ogden Environmental and Energy Services Co., Inc. (listed in table as Ogden), 1996, and Regan and others, 2006. **Methods:** Belt trans, quantitatively sampled with a belt transect methodology; C, census, total count or estimate of the number of individuals in the occurrence, either using GPS or not; CvrEst, cover estimated; GPS, occurrence boundary or patch boundaries within the occurrence mapped with GPS (Global Positioning System); NA, Monitoring not required in 1996 Plan (Ogden Environmental Energy Services Co., Inc., 1996); S, survey, check site for the presence of the taxon; P/A, Presence/Absence, check site to see whether taxon is present, or absent; Plots, quantitatively sampled with a plot-based sample design. Sites in BOLD print are from various agency files, reports and databases, including the City of San Diego, San Diego County, USFWS Carlsbad Ecological Services, USFWS San Diego National Wildlife Refuge, USFWS San Diego South Bay Refuges. **Sources of information:** Conservation Biology Institute, 2001; Hickman, 1993; Ogden Environmental and Energy Services Co., Inc., 1996; and Regan and others, 2006. **Abbreviations:** B; BLM, Bureau of Land Management; DFG, California Department of Fish and Game; DOD, Dept. of Defense; USFWS, U.S. Fish and Wildlife Service; NPS, National Park Service; SDNWR, San Diego National Wildlife Refuge; SDSU, San Diego state University; TNC, The Nature Conservancy; USFPWS, U.S. Fish and Wildlife Service]

Monitoring program (species)	Priority table 5-1 and SDSU	Monitoring location	Responsible agency	Method	Year
<i>Acanthomintha ilicifolia</i>	Table 5-1	4SRanch (LHodges) Santa Fe Valley P2	County	S(notfound)	01
San Diego thormint (narrow endemic)	Second	South Poway/Sycamore Canyon P13 McGinty Mountain P17	County TNC	C S,C(FWS)	05 05
	SDSU 1	Jamul Mountains West P30 Sabre Springs/Poway El Capitan Alpine Otay Lakes P30? Asphalt, Inc. <b>Black Mountain Ranch</b> <b>Mission Trails Regional Park</b> <b>Penasquitos Canyon</b> <b>Hollenbeck River/Rancho Jamul</b>	County (private Otay Resort) Cities San Diego & Poway County County City of San Diego County (private) City of San Diego City of San Diego City of San Diego County/DFG	C C C C C C C C C (trans)	00, 01, 02, 03, 04, 05 ~2004 01, 02, 03, 04 00, 01, 02, 03, 04, 05 01, 02, 03, 04, 05 00, 01, 02, 03, 04, 05
<i>Agave shawii</i> ssp. <i>shawii</i>	Table 5-1	Verified, unspecified location	City of Imperial Beach		
Shaw's agave(narrow endemic)	No monitoring required <sup>1</sup>	Verified, unspecified location (Ogden table 2-1)	City of San Diego		
	SDSU 2				
<i>Ambrosia pumila</i>	Table 5-1	Santee Mission Trails P16	Cities of Santee & San Diego	Plots	99, 00, 01, 03
San Diego ambrosia (narrow endemic)	Second	(Site P26 was included here, but later identification showed the plant was a more common ambrosia) <b>Site 49</b> <b>Par Four</b> <b>Sweetwater River/Steele Canyon Bridge Site34</b>	private USFWS SDNWR USFWS SDNWR	C (GPS) C (GPS)	03, 05 03, 05
<i>Aphanisma blitoides</i> Aphanisma		No naturally occurring populations in the MSCP (Conservation Biology Institute, 2001)			



**Appendix A. San Diego Multiple Species Conservation Program covered rare plants: Summary of surveys and monitoring across jurisdictions—Continued.**

[**Priority table 5-1 and SDSU:** Priority rankdesignings from Ogdan Environmental and Energy Services Co., Inc. (listed in table as Ogdan), 1996, and Regan and others, 2006. **Methods:** Belt trans. quantitatively sampled with a belt transect methodology; C, census, total count or estimate of the number of individuals in the occurrence, either using GPS or not; CvrEst, cover estimated; GPS, occurrence boundary or patch boundaries within the occurrence mapped with GPS (Global Positioning System); NA, Monitoring not required in 1996 Plan (Ogden Environmental Energy Services Co., Inc., 1996); S, survey, check site for the presence of the taxon; P/A, Presence/Absence, check site to see whether taxon is present, or absent; Plots, quantitatively sampled with a plot-based sample design. Sites in BOLD print are from various agency files, reports and databases, including the City of San Diego, San Diego County, USFWS Carlsbad Ecological Services, USFWS San Diego National Wildlife Refuge, USFWS San Diego South Bay Refuges. **Sources of information:** Conservation Biology Institute, 2001; Hickman, 1993; Ogdan Environmental and Energy Services Co., Inc., 1996; and Regan and others, 2006. **Abbreviations:** B; BLM, Bureau of Land Management; DFG, California Department of Fish and Game; DOD, Dept. of Defense; USFWS, U.S. Fish and Wildlife Service; NPS, National Park Service; SDNWR, San Diego National Wildlife Refuge; SDSU, San Diego state University; TNC, The Nature Conservancy; USFWS, U.S. Fish and Wildlife Service]

Monitoring program (species)	Priority table 5-1 and SDSU	Monitoring location	Responsible agency	Method	Year
<i>Arctostaphylos glandulosa</i>	Table 5-1	Del Mar Heights (Crest Canyon) P3	City of San Diego	C	02
<i>ssp. crassifolia</i>	Third	San Dieguito River Bluffs P5	City of San Diego	C	
Del Mar manzanita	SDSU 1	Torrey Pines State Park Extension P6	State parks		
		Torrey Pines State Park P7	State parks		
		Carmel Mountain P8	City of San Diego	C	02
		Del Mar Mesa P10	City of San Diego	C	
		Los Penasquitos Canyon P12	City of San Diego	C	02
<i>Arctostaphylos otayensis</i>	Table 5-1	Verified, unspecified location	County/BLM/DFG/FWS		
Otay manzanita	Second	(Ogden table 2-1)			
	SDSU 2	Otay Mountain			
		Rancho Jamul			
		San Miguel Mountain			
<i>Astragalus tener</i> var. <i>titi</i>	Extirpated	Unverified	City of Coronado		
Coastal dunes milkvetch		(Ogden table 2-1)			
<i>Baccharis vammessae</i>	Table 5-1	4S Ranch/Rancho Cielo P1	County	C	05
<i>Encinitas baccharis</i>	Third	Poway	City of Poway		
(narrow endemic)	SDSU 1	Iron Mountain	City of Poway		
<i>Berberis nevinii</i>		Verified, unspecified locations	County		
Nevin's barberry		(Ogden table 2-1)			
<i>Brodiaea filifolia</i>	Extirpated?	Verified, unspecified location			
Thread-leaved brodiaea (vernal pools)		(Ogden table 2-1)			
		<b>4S Ranch South</b>	County	S	00, 01, 02, 03, 05
<i>Brodiaea orcuttii</i>	Table 5-1	Carmel Mountain P9	City of San Diego	S	01
Orcutt's brodiaea	Second	Del Mar Mesa P11	City of San Diego	C	01, 02, 03
		East Otay Mesa P32	County (private)		
	SDSU 3	Cedar Canyon P33	BLM		
		<b>Nobel Drive</b>	City of San Diego	C	01, 02, 03, 05
		<b>Carrol Canyon</b>	City of San Diego	Plots	01, 02, 03, 05
		<b>General Dynamics</b>	City of San Diego	Plots	01, 02, 03, 05
		<b>Otay Lakes South/Otay Mountain</b>	County	S	01

**Appendix A. San Diego Multiple Species Conservation Program covered rare plants: Summary of surveys and monitoring across jurisdictions—Continued.**

[**Priority table 5-1 and SDSU:** Priority rank redesigns from Ogdan Environmental and Energy Services Co., Inc. (listed in table as Ogdan), 1996, and Regan and others, 2006. **Methods:** Belt transects, quantitatively sampled with a belt transect methodology; C, census, total count or estimate of the number of individuals in the occurrence, either using GPS or not; CvrEst, cover estimated; GPS, occurrence boundary or patch boundaries within the occurrence mapped with GPS (Global Positioning System); NA, Monitoring not required in 1996 Plan (Ogdan Environmental Energy Services Co., Inc., 1996); S, survey, check site for the presence of the taxon; P/A, Presence/Absence, check site to see whether taxon is present, or absent; Plots, quantitatively sampled with a plot-based sample design. Sites in BOLD print are from various agency files, reports and databases, including the City of San Diego, San Diego County, USFWS Carlsbad Ecological Services, USFWS San Diego National Wildlife Refuge, USFWS San Diego South Bay Refuges. **Sources of information:** Conservation Biology Institute, 2001; Hickman, 1993; Ogdan Environmental and Energy Services Co., Inc., 1996; and Regan and others, 2006. **Abbreviations:** B; BLM, Bureau of Land Management; DFG, California Department of Fish and Game; DOD, Dept. of Defense; USFWS, U.S. Fish and Wildlife Service; NPS, National Park Service; SDNWR, San Diego National Wildlife Refuge; SDSU, San Diego state University; TNC, The Nature Conservancy; USFWS, U.S. Fish and Wildlife Service]

Monitoring program (species)	Priority table 5-1 and SDSU	Monitoring location	Responsible agency	Method	Year
<i>Calamagrostis densa</i> (lumped with <i>Calamagrostis koelerioides</i> ; Hickman and others, 1993)	Table 5-1 NA	Verified, unspecified location Verified, unspecified location (Ogden table 2-1)	City of Poway County		
Dense reed grass					
<i>Calochortus dumii</i> Dunn's mariposa lily	Table 5-1 Third SDSU 2	Verified, unspecified location (Ogden table 2-1) <b>San Miguel</b> <b>Las Montanas</b> <b>Jamul Mountains</b> <b>Otay Mountain</b>	County USFWS, SDNWR USFWS, SDNWR Unknown BLM	P/A	03, 05
<i>Caulanthus heterophyllus</i> var. <i>heterophyllus</i> (lumped with <i>Caulanthus stenocarpus</i> ; Hickman and others, 1993)	Table 5-1 No monitoring required	Verified, unspecified location Verified, unspecified location	City of Poway City of San Diego		
Slender-pod jewelflower		Verified, unspecified location Unverified (Ogden Table 2-1)	County Santee		
<i>Ceanothus cyaneus</i> Lakeside ceanothus (narrow endemic)	Table 5-1 Second SDSU 2	<b>San Vicente (Foster Canyon)</b> Barona Valley-Wildcat Canyon Ramona El Cajon Mountain Crest-Haribison Canyon	County County County County County	S	01
<i>Ceanothus verrucosus</i> Wart-stemmed ceanothus	Table 5-1 First SDSU 3	<b>San Vicente (Foster Canyon)</b> Spooner's Mesa Carmel Mountain Crest Canyon DeI Mar Highlands Santa Fe Valley	County County City of San Diego City of San Diego City of San Diego County	C	01, 03
<i>Cordylanthus maritimus</i> ssp. <i>maritimus</i>	Table 5-1	Sweetwater River mouth and vicinity P20	USFWS, South Bay Refuge	C	?
Salt marsh birds-beak	First SDSU 2	South San Diego Bay Wetlands P21 Tijuana River estuary and vicinity P22	USFWS, South Bay Refuge USFWS South Bay Refuge	C C	?
<i>Cordylanthus orcuttianus</i> Orcutt's birds-beak	Table 5-1 First SDSU 1	Goat Cyn/Spooner's Mesa P23 Otay River Valley	County City of San Diego	Plots	01, 02, 03, 04, 05

**Appendix A. San Diego Multiple Species Conservation Program covered rare plants: Summary of surveys and monitoring across jurisdictions—Continued.**

[**Priority table 5-1 and SDSU:** Priority rankdesignms from Ogden Environmental and Energy Services Co., Inc. (listed in table as Ogden), 1996, and Regan and others, 2006. **Methods:** Belt trans. quantitatively sampled with a belt transect methodology; C, census, total count or estimate of the number of individuals in the occurrence, either using GPS or not; CvrEst, cover estimated; GPS, occurrence boundary or patch boundaries within the occurrence mapped with GPS (Global Positioning System); NA, Monitoring not required in 1996 Plan (Ogden Environmental Energy Services Co., Inc., 1996); S, survey, check site for the presence of the taxon; P/A, Presence/Absence, check site to see whether taxon is present, or absent; Plots, quantitatively sampled with a plot-based sample design. Sites in BOLD print are from various agency files, reports and databases, including the City of San Diego, San Diego County, USFWS Carlsbad Ecological Services, USFWS San Diego National Wildlife Refuge, USFWS San Diego South Bay Refuges. **Sources of information:** Conservation Biology Institute, 2001; Hickman, 1993; Ogden Environmental and Energy Services Co., Inc., 1996; and Regan and others, 2006. **Abbreviations:** B; BLM, Bureau of Land Management; DFG, California Department of Fish and Game; DOD, Dept. of Defense; USFWS, U.S. Fish and Wildlife Service; NPS, National Park Service; SDNWR, San Diego National Wildlife Refuge; SDSU, San Diego state University; TNC, The Nature Conservancy; USFWS, U.S. Fish and Wildlife Service]

Monitoring program (species)	Priority table 5-1 and SDSU	Monitoring location	Responsible agency	Method	Year
<i>Cylindropuntia californica</i> var. <i>californica</i>	Table 5-1	Poggi Canyon P24	City of Chula Vista	C, P/A	02, 05
<i>Opuntia parryi</i> var. <i>serpentina</i>	Third	Spring Canyon P26	City of San Diego		
Snake cholla	SDSU 2	Lower Salt Creek P31 Border Field State Park Sweetwater Marsh Point Loma <b>Otay Mesa</b> <b>Balboa Park</b> <b>upstream of Steele Canyon Bridge</b> <b>South of Steele Canyon Bridge</b> <b>Steele Canyon Ck east of Millar Ranch Road</b>	City of Chula Vista State parks USFWS South Bay Refuge NPS and City of San Diego City of San Diego City of San Diego USFWS SDNWR USFWS SDNWR USFWS SDNWR	C C S C C S C C	02, 05 02 05 05 05
<i>Cupressus forbesii</i>	Table 5-1	Verified, unspecified location	County		
Tecate cypress	Third	(Ogden table 2-1)	County	S	01
	SDSU 1	<b>Otay Lakes South</b> <b>Otay Mountain</b> <b>Otay Mtn Village 15 parcel</b>	BLM USFWS	S	06
<i>Deinandra conjugens</i>	Table 5-1	San Miguel Mountain P19	USFWS, SDNWR	Plots	03, 05
( <i>Hemizonia conjugens</i> )	First	Poggi Canyon P24	City of Chula Vista		
(narrow endemic)	SDSU 1	Wolf Canyon P27 Otay River West P28 Proctor Valley P29 <b>Trimark</b> <b>Jamacha Road</b>	City of Chula Vista City of Chula Vista USFWS/City of San Diego USFWS SDNWR USFWS SDNWR	BeltTrans S (GPS) S (GPS)	03, 04, 05 03, 04, 05 05
<i>Dudleya blochmaniae</i> ssp. <i>brevifolia</i>	Table 5-1	Del Mar Heights/Crest Canyon P3	City of San Diego	C	01, 02, 03, 04, 05
Short-leaved Dudleya	First	Torrey Pines State Park Extension P6	State Parks		
(narrow endemic)	SDSU 1	Torrey Pines State Park P7 Carmel Mountain P8 <b>Skeleton Canyon</b>	State Parks City of San Diego City of San Diego	GPS boundary Plots C	03 (City, for State parks) 99, 00, 01, 02, 03, 04, 05 01, 02, 03, 04

**Appendix A. San Diego Multiple Species Conservation Program covered rare plants: Summary of surveys and monitoring across jurisdictions—Continued.**

[**Priority table 5-1 and SDSU:** Priority rank redesigns from Ogdon Environmental and Energy Services Co., Inc. (listed in table as Ogdon), 1996, and Regan and others, 2006. **Methods:** Belt trans, quantitatively sampled with a belt transect methodology; C, census, total count or estimate of the number of individuals in the occurrence, either using GPS or not; CvrEst, cover estimated; GPS, occurrence boundary or patch boundaries within the occurrence mapped with GPS (Global Positioning System); NA, Monitoring not required in 1996 Plan (Ogdon Environmental Energy Services Co., Inc., 1996); S, survey, check site for the presence of the taxon; P/A, Presence/Absence, check site to see whether taxon is present, or absent; Plots, quantitatively sampled with a plot-based sample design. Sites in BOLD print are from various agency files, reports and databases, including the City of San Diego, San Diego County, USFWS Carlsbad Ecological Services, USFWS San Diego National Wildlife Refuge, USFWS San Diego South Bay Refuges. **Sources of information:** Conservation Biology Institute, 2001; Hickman, 1993; Ogdon Environmental and Energy Services Co., Inc., 1996; and Regan and others, 2006. **Abbreviations:** B; BLM, Bureau of Land Management; DFG, California Department of Fish and Game; DOD, Dept. of Defense; USFWS, U.S. Fish and Wildlife Service; NPS, National Park Service; SDNWR, San Diego National Wildlife Refuge; SDSU, San Diego state University; TNC, The Nature Conservancy; USFWS, U.S. Fish and Wildlife Service]

Monitoring program (species)	Priority table 5-1 and SDSU	Monitoring location	Responsible agency	Method	Year
<i>Dudleya variegata</i>	Table 5-1	Sycamore Canyon/East Elliot/Fanita P15	Cities of San Diego and Santee	C	04
Variiegated Dudleya (narrow endemic)	First	Otay River West P28	Cities of Chula Vista and San Diego and County	C	05
	SDSU 2	Lower Salt Creek P31	City of Chula Vista	Belt trans	01, 02, 03, 04, 05
		Marron Valley P34	City of San Diego	C	01, 02, 03, 04
		Proctor Valley	County/others?	C	01, 02, 03
		Otay Lakes	City of San Diego	C	01, 02, 03, 04, 05
		Margerum Ave	City of San Diego	C	01, 02, 03, 04
		Mercy Road	City of San Diego	C	01, 02, 03, 04, 05
		Mission Trails Regional Park	City of San Diego	C	01, 02, 03, 04, 05
		Spring Canyon	City of San Diego	C	01, 02, 03, 04, 05
		Black Mountain Ranch	City of San Diego	C	01, 02, 03, 04, 05
		4S Ranch South	County	C,S	01, 05
		Santa Fe Valley	County	C	01,05
		Lusardi	County	C, Plots	01, 05
		Sweetwater Reservoir San Miguel Ranch P18-DV1	USFWS SDNWR	Plots	02, 05
		Sweetwater Reservoir San Miguel Ranch P18-DV2	USFWS SDNWR	Plots	02, 05
		Sweetwater Reservoir San Miguel Ranch P18-DV3	USFWS SDNWR	Plots	02
		Sweetwater Reservoir San Miguel Ranch P18-DV4	USFWS SDNWR	Plots	02
		Sweetwater Reservoir San Miguel Ranch P18-DV5	USFWS SDNWR	Plots	03, 05
<i>Dudleya viscida</i>	Table 5-1	Verified, unspecified location	County		
Sticky Dudleya	NA	(Ogden table 2-1)			
	SDSU 2				

**Appendix A. San Diego Multiple Species Conservation Program covered rare plants: Summary of surveys and monitoring across jurisdictions—Continued.**

[**Priority table 5-1 and SDSU:** Priority rank redesigns from Ogden Environmental and Energy Services Co., Inc. (listed in table as Ogden), 1996, and Regan and others, 2006. **Methods:** Belt trans, quantitatively sampled with a belt transect methodology; C, census, total count or estimate of the number of individuals in the occurrence, either using GPS or not; CvrEst, cover estimated; GPS, occurrence boundary or patch boundaries within the occurrence mapped with GPS (Global Positioning System); NA, Monitoring not required in 1996 Plan (Ogden Environmental Energy Services Co., Inc., 1996); S, survey, check site for the presence of the taxon; P/A, Presence/Absence, check site to see whether taxon is present, or absent; Plots, quantitatively sampled with a plot-based sample design. Sites in BOLD print are from various agency files, reports and databases, including the City of San Diego, San Diego County, USFWS Carlsbad Ecological Services, USFWS San Diego National Wildlife Refuge, USFWS San Diego South Bay Refuges. **Sources of information:** Conservation Biology Institute, 2001; Hickman, 1993; Ogden Environmental and Energy Services Co., Inc., 1996; and Regan and others, 2006. **Abbreviations:** B; BLM, Bureau of Land Management; DFG, California Department of Fish and Game; DOD, Dept. of Defense; USFWS, U.S. Fish and Wildlife Service; NPS, National Park Service; SDNWR, San Diego National Wildlife Refuge; SDSU, San Diego state University; TNC, The Nature Conservancy; USFWS, U.S. Fish and Wildlife Service]

<b>Monitoring program (species)</b>	<b>Priority table 5-1 and SDSU</b>	<b>Monitoring location</b>	<b>Responsible agency</b>	<b>Method</b>	<b>Year</b>
<i>Ericameria palmeri</i> ssp. <i>palmeri</i> Palmer's ericameria	Table 5-1 Third No monitoring required	Verified, unspecified location Verified, unspecified location Verified, unspecified location (Ogden table 2-1) Dehesa Road Triangle Parcel Site 6 <b>Jamacha Boulevard Site 3</b> <b>Las Montanas Site 4</b> <b>Mesa Site 2</b> <b>Revegetation Site Site 8</b> <b>South of the Mesa Site 7</b> <b>Steele Canyon Creek Site 5</b> <b>Sweetwater River Willow Glen Road Site 1</b>	City of Poway City of San Diego County USFWS SDNWR USFWS SDNWR USFWS SDNWR USFWS SDNWR USFWS SDNWR USFWS SDNWR USFWS SDNWR USFWS SDNWR	C C P/A P/A P/A	02 02 02 02 02, 05
<i>Eryngium aristulatum</i> var. <i>parishii</i> San Diego button celery (vernal pool)	Table 5-1 NA	Otay River Valley Otay Lakes	County and City of San Diego City of San Diego	S (+cover)	03 03
<i>Erysimum ammophilum</i> Coast wallflower	Table 5-1 NA	Proctor Valley Del Mar Mesa	County/City of San Diego/USFWS/private City of San Diego	S (+cover)	03
<i>Ferocactus viridescens</i> var. <i>viridescens</i> San Diego barrel cactus	SDSU 2	Tierrasanta Citywide	City of San Diego City of San Diego	S (+cover) S (+cover)	03 03
	Table 5-1 NA Table 5-1 Third SDSU 3	Verified, unspecified locations (Ogden table 2-1) <b>Lusardi Creek</b> <b>Jamul Mountains/Otay North</b> <b>Otay Lakes</b> <b>4S Ranch South</b> <b>Santa Fe Valley</b> <b>Otay Lakes South/Otay Mountains</b> <b>“V” Parcel</b> <b>Inverted L Parcel</b> <b>San Miguel Ranch</b>	Cities of Chula Vista, Del Mar, La Mesa, Lemon Grove, National City, Poway, San Diego, Santee, County County County/City of San Diego County County County USFWS SDNWR USFWS SDNWR USFWS SDNWR	S S S, C S, C S C	01 01 01 01, 05 01 01

**Appendix A. San Diego Multiple Species Conservation Program covered rare plants: Summary of surveys and monitoring across jurisdictions—Continued.**

[**Priority table 5-1 and SDSU:** Priority rank redesigns from Ogden Environmental and Energy Services Co., Inc. (listed in table as Ogden), 1996, and Regan and others, 2006. **Methods:** Belt transects, quantitatively sampled with a belt transect methodology; C, census, total count or estimate of the number of individuals in the occurrence, either using GPS or not; CvrEst, cover estimated; GPS, occurrence boundary or patch boundaries within the occurrence mapped with GPS (Global Positioning System); NA, Monitoring not required in 1996 Plan (Ogden Environmental Energy Services Co., Inc., 1996); S, survey, check site for the presence of the taxon; P/A, Presence/Absence, check site to see whether taxon is present, or absent; Plots, quantitatively sampled with a plot-based sample design. Sites in BOLD print are from various agency files, reports and databases, including the City of San Diego, San Diego County, USFWS Carlsbad Ecological Services, USFWS San Diego National Wildlife Refuge, USFWS San Diego South Bay Refuges. **Sources of information:** Conservation Biology Institute, 2001; Hickman, 1993; Ogden Environmental and Energy Services Co., Inc., 1996; and Regan and others, 2006. **Abbreviations:** B; BLM, Bureau of Land Management; DFG, California Department of Fish and Game; DOD, Dept. of Defense; USFWS, U.S. Fish and Wildlife Service; NPS, National Park Service; SDNWR, San Diego National Wildlife Refuge; SDSU, San Diego state University; TNC, The Nature Conservancy; USFWS, U.S. Fish and Wildlife Service]

Monitoring program (species)	Priority table 5-1 and SDSU	Monitoring location	Responsible agency	Method	Year
<i>Lepechinia cardiophylla</i> Heart-leaved pitcher sage	Table 5-1 Second	Iron Mountain	City of Poway and County		
<i>Lepechinia ganderi</i> Gander's pitcher sage	Table 5-1 Third	Verified, unspecified locations (Ogden table 2-1) Otay Mtn	County		
<i>Lessingia flaginifolia</i> var. <i>linifolia</i> ( <i>Corethrogyne flaginifolia</i> var. <i>linifolia</i> ) (lumped with <i>L. flaginifolia</i> var. <i>flaginifolia</i> Hickman and others, 1993)	SDSU 2	San Miguel Mountain	BLM USFWS SDNWR	P/A	05
<i>Lotus nuttallianus</i> Nuttall's lotus	Table 5-1 First	SanDieguito Red Bluffs/Overlook Park/ToHi P4 Torrey Pines State Park P7 Del Mar Mesa P10 Del Mar Highlands Carmel Mountain	City of San Diego State parks City of San Diego City of San Diego City of San Diego	C S S C	01, 02, 03, 05 01 01 01, 02, 03, 05
<i>Monardella hypoleuca</i> ssp. <i>lanata</i> Felt-leaved monardella	Table 5-1 Third	Tijuana River Estuary and Vicinity P22 D Street fill Border Field State Park <b>Mariners Point Site 4</b> <b>West No Mens Land Site 6</b> <b>Hospitality Point Site 2</b> <b>SD Riv Fld Cntrl CH/Rip Rap Site 3</b> <b>No Mens Land Site 1</b>	USFWS South Bay Refuge USFWS South Bay Refuge State parks City of San Diego City of San Diego City of San Diego City of San Diego City of San Diego	P/A Line Intercept C C Line Intercept	02, 03, 04 03, 04, 05 01, 05 01, 02, 05 03, 04, 05
<i>Monardella viminea</i> ( <i>Monardella limoides</i> ssp. <i>viminea</i> ) Willoway monardella (narrow endemic)	Table 5-1 First SDSU 2	Sequan Peak Iron Mountain McGinty <b>Gallant, Gamble and Pyramid</b> Santee/Sycamore Canyon P14 <b>Lopez Canyon</b> <b>Otay Lakes</b> <b>Sycamore Canyon/Rancho Encantada</b> <b>Otay Lakes South/Otay Mountains</b>	DFG ? County/DFG/USFWS/TNC County County City of San Diego City of San Diego City of San Diego County/BLM/Cities	S S C C C C S	01 1982 05 00, 01, 0 2 03, 04, 05 00, 01, 0 2 03, 04 00, 01, 0 2 03, 04, 05 01

**Appendix A. San Diego Multiple Species Conservation Program covered rare plants: Summary of surveys and monitoring across jurisdictions—Continued.**

[**Priority table 5-1 and SDSU:** Priority rank redesigns from Ogden Environmental and Energy Services Co., Inc. (listed in table as Ogden), 1996, and Regan and others, 2006. **Methods:** Belt trans, quantitatively sampled with a belt transect methodology; C, census, total count or estimate of the number of individuals in the occurrence, either using GPS or not; CvrEst, cover estimated; GPS, occurrence boundary or patch boundaries within the occurrence mapped with GPS (Global Positioning System); NA, Monitoring not required in 1996 Plan (Ogden Environmental Energy Services Co., Inc., 1996); S, survey, check site for the presence of the taxon; P/A, Presence/Absence, check site to see whether taxon is present, or absent; Plots, quantitatively sampled with a plot-based sample design. Sites in BOLD print are from various agency files, reports and databases, including the City of San Diego, San Diego County, USFWS Carlsbad Ecological Services, USFWS San Diego National Wildlife Refuge, USFWS San Diego South Bay Refuges. **Sources of information:** Conservation Biology Institute, 2001; Hickman, 1993; Ogden Environmental and Energy Services Co., Inc., 1996; and Regan and others, 2006. **Abbreviations:** B; BLM, Bureau of Land Management; DFG, California Department of Fish and Game; DOD, Dept. of Defense; USFWS, U.S. Fish and Wildlife Service; NPS, National Park Service; SDNWR, San Diego National Wildlife Refuge; SDSU, San Diego state University; TNC, The Nature Conservancy; USFWS, U.S. Fish and Wildlife Service]

Monitoring program (species)	Priority table 5-1 and SDSU	Monitoring location	Responsible agency	Method	Year
<i>Monardella stoneana</i>	Table 5-1	Cedar Canyon P33	BLM		
( <i>Monardella linooides</i> ssp. <i>viminea</i> )	NA	Marron Valley	City of San Diego	C	00, 01, 0 2 03, 04, 05
Monardella (narrow endemic)					
(new taxon @ Cedar Canyon and Marron Valley)					
<i>Mulla clevelandii</i>	Table 5-1	Del Mar Mesa P11	City of San Diego	C	01, 02, 03
San Diego goldenstar	Second	Sycamore Cyn/East Elliot P15 East Otay Mesa P32	City of San Diego County (private)		
	SDSU 2	Northeast San Ysidro Mountains P35 Otay Ranch P 4S Ranch Dehesa Proctor Valley/Jamul Mountains. Marron Valley Otay Lakes Mission Trails Regional Park San Vicente (Foster Canyon) Otay Lakes South/Otay Mountains Inverted L Parcel San Miguel Ranch P18 (DV5) Trimark	County/DFG? City of Chula Vista County County (private?) County/DFG?/others? City of San Diego and County City of San Diego City of San Diego County County/BLM USFWS SDNWR USFWS SDNWR USFWS SDNWR	S S S Belt trans Belt trans C C S	01, 05 00, 04 01, 02, 04, 05 01, 02, 03 01, 03 01
<i>Myosurus minimus</i> ssp. <i>apus</i>	Table 5-1	Verified, unspecified locations	City of San Diego	Plots	03, 05
Little mouse tail	NA	Verified, unspecified locations Unverified (Ogden table 2-1) Citywide	County City of Chula Vista	not found	03, 05
<i>Navarretia fossalis</i>	Table 5-1	Citywide	City of San Diego	S/Cvr Est	03
Prostrate navarretia (vernal pool)	NA	Otay Mesa Citywide	City of San Diego City of San Diego	S/Cvr Est	03
	SDSU 1				

**Appendix A. San Diego Multiple Species Conservation Program covered rare plants: Summary of surveys and monitoring across jurisdictions—Continued.**

[**Priority table 5-1 and SDSU:** Priority rank designations from Ogdon Environmental and Energy Services Co., Inc. (listed in table as Ogden), 1996, and Regan and others, 2006. **Methods:** Belt transects, quantitatively sampled with a belt transect methodology; C, census, total count or estimate of the number of individuals in the occurrence, either using GPS or not; CvrEst, cover estimated; GPS, occurrence boundary or patch boundaries within the occurrence mapped with GPS (Global Positioning System); NA, Monitoring not required in 1996 Plan (Ogden Environmental Energy Services Co., Inc., 1996); S, survey, check site for the presence of the taxon; P/A, Presence/Absence, check site to see whether taxon is present, or absent; Plots, quantitatively sampled with a plot-based sample design. Sites in BOLD print are from various agency files, reports and databases, including the City of San Diego, San Diego County, USFWS Carlsbad Ecological Services, USFWS San Diego National Wildlife Refuge, USFWS San Diego South Bay Refuges. **Sources of information:** Conservation Biology Institute, 2001; Hickman, 1993; Ogdon Environmental and Energy Services Co., Inc., 1996; and Regan and others, 2006. **Abbreviations:** B; BLM, Bureau of Land Management; DFG, California Department of Fish and Game; DOD, Dept. of Defense; USFWS, U.S. Fish and Wildlife Service; NPS, National Park Service; SDNWR, San Diego National Wildlife Refuge; SDSU, San Diego state University; TNC, The Nature Conservancy; USFWS, U.S. Fish and Wildlife Service]

Monitoring program (species)	Priority table 5-1 and SDSU	Monitoring location	Responsible agency	Method	Year
<i>Nolina interrata</i> Dehesa bear-grass	Table 5-1 Second	Verified, unspecified locations McGinty	County County/USFWS/DFG/TNC	P/A	01, 05
	SDSU 1	Doeñes Mexican Canyon Immenschue grassland McGinty Mountain Sycuan Peak and ridgelines	USFWS SDNWR USFWS SDNWR USFWS SDNWR DFG	P/A	05
<i>Packera ganderi</i> ( <i>Senecio ganderi</i> ) Gander's butterweed	Table 5-1 Second	McGinty Mountain Sequan Peak El Cajon Mountain	USFWS SDNWR CDFG County		
<i>Orcuttia californica</i> California Orcutt grass (vernal pool)	SDSU 2 Table 5-1 NA	McGinty Mountain Otay Mesa Citywide	County/USFWS/DFG/TNC County City of San Diego	S Cvr Est	01 03
<i>Pinus torreyana</i> Torrey pine	SDSU 1 Table 5-1 NA	Torrey Pines State Reserve	State parks		
<i>Pogogyne ambramsii</i> San Diego Mesa mint (vernal pool)	SDSU 1 Table 5-1 NA	Verified, unspecified locations Verified, unspecified locations (Ogden table 2-1)	City of Santee County		
<i>Pogogyne nudiuscula</i> Otay Mesa mint (vernal pool)	SDSU 2 Table 5-1 NA	Citywide Verified, unspecified locations Unverified (Ogden table 2-1)	City of San Diego County City of Chula Vista	S/Cvr Est	03
<i>Rosa minutifolia</i> Small-leaved rose	SDSU 1 Table 5-1 Third	Citywide Otay River Valley/West Otay Mesa P25 (planted population @ California Terraces)	City of San Diego City of San Diego (Private)	S/Cvr Est	03
<i>Satureja chandleri</i> San Miguel savory	SDSU 1 Table 5-1 Second SDSU 3	Verified, unspecified locations (Ogden table 2-1) San Miguel Mountain Rancho Jamul (Jamul Mountains)	County USFWS DFG/County (private)	P/A	05



**Appendix A. San Diego Multiple Species Conservation Program covered rare plants: Summary of surveys and monitoring across jurisdictions—Continued.**

[**Priority table 5-1 and SDSU:** Priority rankdesignings from Ogden Environmental and Energy Services Co., Inc. (listed in table as Ogden), 1996, and Regan and others, 2006. **Methods:** Belt trans. quantitatively sampled with a belt transect methodology; C, census, total count or estimate of the number of individuals in the occurrence, either using GPS or not; CvrEst, cover estimated; GPS, occurrence boundary or patch boundaries within the occurrence mapped with GPS (Global Positioning System); NA, Monitoring not required in 1996 Plan (Ogden Environmental Energy Services Co., Inc., 1996); S, survey, check site for the presence of the taxon; P/A, Presence/Absence, check site to see whether taxon is present, or absent; Plots, quantitatively sampled with a plot-based sample design. Sites in BOLD print are from various agency files, reports and databases, including the City of San Diego, San Diego County, USFWS Carlsbad Ecological Services, USFWS San Diego National Wildlife Refuge, USFWS San Diego South Bay Refuges. **Sources of information:** Conservation Biology Institute, 2001; Hickman, 1993; Ogden Environmental and Energy Services Co., Inc., 1996; and Regan and others, 2006. **Abbreviations:** B; BLM, Bureau of Land Management; DFG, California Department of Fish and Game; DOD, Dept. of Defense; USFWS, U.S. Fish and Wildlife Service; NPS, National Park Service; SDNWR, San Diego National Wildlife Refuge; SDSU, San Diego state University; TNC, The Nature Conservancy; USFWS, U.S. Fish and Wildlife Service]

Monitoring program (species)	Priority table 5-1 and SDSU	Monitoring location	Responsible agency	Method	Year
<i>Solanum tenuilobatum</i> (lumped with <i>Solanum xanthi</i> Hickman and others, 1993)	Table 5-1 Second No Monitoring Required SDSU NA	Unverified Unverified Unverified Verified, unspecified locations (Ogden table 2-1) Otay Mountain	City of Poway City of San Diego City of Santee County BLM		
<i>Tetracoccus dioicus</i> Perry's tetracoccus	Table 5-1 Second SDSU 3	Unverified Verified, unspecified locations (Ogden table 2-1) Gallant, Gamble and Pyramid Verizon Wireless Pala Road Forsyth Lot Split Dehesa Valley Sequan Peak McGinty Mountain Ysidro Mountains	City of Poway County County County USFWS? DFG TNC (County, DFG, USFWS) USFWS?	S S S S? S? P/A S?	1982 1982 1982 01, 05
<b>Taxa considered but not included in monitoring program</b>					
<i>Astragalus deanei</i> Dean's milkvetch	Table 5-1 NA	Unverified (Ogden table 2-1)	City of Coronado		
<i>Chorizanthe orcuttiana</i> Orcutt's spineflower	Table 5-1 NA	Point Loma	NPS/DOD		
<i>Deinandra floribunda</i> ( <i>Hemizonia floribunda</i> )	Table 5-1 NA				
<i>Fremontodendron mexicanum</i> Mexican flannelbush	Table 5-1 NA				
<i>Githopsis diffusa</i> spp. <i>filicaulis</i> Mission Canyon blue-cup	Table 5-1 NA				

MSCP plans do not call for monitoring of several covered plant species.

This page intentionally left blank.

## Appendix B. Assessment of Current Monitoring Data for Detecting Change (the Success of the Multiple Species Conservation Program (MSCP))

An essential component of population monitoring is the sampling design used to detect the effect of management or the change in status in populations of concern. The goal of a sampling design is to obtain a level of data precision that allows the efficient (in resources) and repeatable (over time and investigators) detection of change. There are seven primary decisions that are part of developing a sampling design for a population, species, or habitat (Sutter, 2006). These are:

- Understanding the biology/ecology of the species or ecological system and how it influences sampling and detecting change.
- Identifying the target population, such as the extent of the population to which the biological and statistical inferences from the monitoring data will be made.
- Selecting the appropriate sampling unit and sampling unit size and shape.
- Positioning of the sampling unit in the target population.
- Selecting the temporal duration of the sampling unit, for example, are the sampling units permanent or temporary.
- Determining the number of sampling units needed to meet a specified level of precision.
- Selecting an appropriate frequency of sampling.

These sampling design decisions are used to organize the proposed monitoring protocols for selected species.

We analyzed several long-term datasets from the Multiple Species Conservation Program (MSCP) to assess their ability to detect changes in the underlying population or management unit (City of San Diego MSCP Program, unpublished data). The specific assessments for *Ambrosia* (*Ambrosia pumila*), Variegated Dudleya (*Dudleya variegata*), and Short-leaved Dudleya (*Dudleya blochmaniae* ssp. *brevifolia*) are below. In summary, the datasets we analyzed could statistically detect between a 34 to 400 percent change in population abundance, with most datasets being inadequate to assess management effects or detect declines that might lead to the extirpation of the population. The general reasons for the poor ability to detect change are several:

- A highly variable (clumped, gradients) spatial distribution of the individuals within populations or management units. The more highly variable the distribution of individuals in the population, the more difficult it is to obtain precise estimates of change. Highly variable

data can be identified when sampling units contain lots of zeros (no individuals in the sampling units) or a wide range of counts. There are many ways to reduce this variability through an efficient sampling design.

- Inappropriate delineation of the target population, with sampling boundaries that included large areas with no or few individuals or highly variable numbers of individuals.
- A sampling method that does not adequately incorporate the dormancy/detectability of individuals.
- Inappropriate sampling unit size and shape. This one component of sampling design can improve the precision of the data and the detection of change.
- Low sample sizes. The larger the sample size, the better the precision of the data. But larger sample sizes may also require more resources to sample. The objective of a sampling design is to obtain a balance between sample size and sampling efficiency.

It was also noted that there are substantial non-sampling errors in the datasets. These are errors caused by the investigators and include non-random placement of sampling units, unrecorded data, conflicting data for the same year, and unrecorded sampling designs. An assumption of all statistical analyses is that non-sampling errors do not exist.

The following are assessments of specific datasets from the MSCP Rare Plant Monitoring Program, City of San Diego, Planning Department, and Multiple Species Conservation Program Division. The data were provided to us by city staff and details about the sampling design were obtained from the MSCP Rare Plant Monitoring Field Methods Manual (City of San Diego, 2005) and personal communication. In all cases, the precision of the data was assessed by visually comparing 90 percent confidence intervals. In a few cases, we also estimated the sample size needed to meet a specific sampling objective and used the sample size equations in Elzinga and others (2001). Sample size equations are based on data from the population to obtain a measure of variability (standard deviation) and contain the assumptions that the data was randomly collected, normally distributed, and independent. There are several types of sample size equations depending on three factors: (1) whether the data will be analyzed by confidence intervals or statistical tests; (2) whether the data comes from permanent or temporary sampling units; and (3) whether one is estimating a mean or total population size or a proportion.

### Short-leaved *Dudleya* (*Dudleya blochmaniae* ssp. *brevifolia*) at Carmel Mountain, Subpopulation 3

This herbaceous perennial species was sampled using 1-meter-square (m<sup>2</sup>) quadrats placed along 11 randomly placed temporary transects spanning the population. Quadrats were systematically placed along each transect at 2 meter intervals for a total of 3 or 4 quadrats per transect. All adult flowering and non-flowering plants were counted in each quadrat. Data were collected from 1999 to 2005, but only data from 2000 to 2005 were analyzed.

Figure B1 shows the mean number of plants per quadrat. The data show that this species is variable over space (illustrated by the 90 percent confidence intervals) and time (the variable mean number of plants per quadrat). There appears to be a pattern in the data, with years with high numbers of plants having similar abundances, while years that have low number of plants are also similar. The pattern could be a response to weather, especially rainfall, but may be related to other environmental, topographic, or demographic factors. The data have a relatively good level of precision, with the 90 percent confidence levels ranging from 34 to 48 percent of the mean. Using a sample size equation for temporary plots assessed by confidence intervals (sample size equation 1 in Elzinga and others, 2001), 95 square meter quadrats are needed to detect a 30 percent change across all years. Larger sample sizes are needed to detect a 30 percent change for the years with high number of individuals (sample sizes ranging from 57 to 95 quadrats), while smaller sample sizes are needed for years with low number of individuals (ranging from 52 to 66). The sample size for estimating the difference between two years

with temporary quadrats using a statistical test (sample size equation 2 in Elzinga and others, 2001) is even greater, with around 370 quadrats needed to detect a 30 percent change across all years.

From this analysis, it is recommended that:

- the sampling design be changed to permanent transects, with another assessment of whether numerous 1 m<sup>2</sup> plots would provide greater precision.

### Variegated *Dudleya* (*Dudleya variegata*) at Otay Lakes

Sixteen randomly placed 1-meter-wide belt transects of varying lengths were used to sample the population of this herbaceous perennial. Belt transects are a logical choice for populations that have distributions that are clumped and/or have internal gradients, since long, narrow quadrats obtain more precise estimates of populations (Elzinga and others, 2001). Data were collected in 2003, 2004, and 2005 and the total number of plants were counted in each belt transect.

The data comparing the changes in the number of individuals in each belt transect, between 2003 and 2005, are shown in figure B2. Eight of the 16 transects showed increases over the two-year period, some with significant increases. Four transects had declines. Four transects did not record any individuals in the two years analyzed.

Since the belt transects were permanent, the appropriate way to analyze the data was to look at the precision of the data using the difference between the 2003 and 2005 values. The mean difference of the count per belt transect was 30, with the 90 percent confidence intervals around the mean being  $\pm 29$ . Thus the current sampling design is barely able to

***Dudleya blochmaniae* ssp. *brevifolia* Monitoring Data for Carmel Mountain Subpopulation 3**

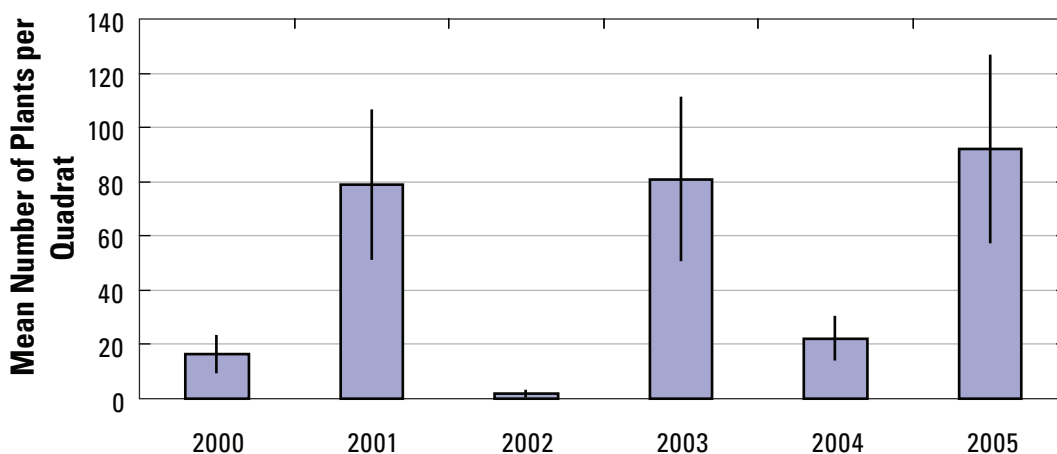

Figure B1. *Dudleya brevifolia* ssp. *brevifolia* monitoring data for Carmel Mountain subpopulation 3.

detect an increase in the population between 2003 and 2005. Thus, while the mean suggests an increase in the population, the sampling design could not statistically detect whether the population was increasing or decreasing.

From this analysis, it is recommended that:

- The target population be redefined (circumscribed) to eliminate areas that do not have the target species.
- Additional belt transects be added to strengthen the ability to detect changes over time. These data will allow for the development of a monitoring objective that states an acceptable level of precision.

### San Diego ambrosia (*Ambrosia pumila*) at Mission Trails Regional Park

San Diego ambrosia, a perennial herb, occurs in several locations within Mission Trails Regional Park, with the largest population adjacent to the Kumeyaay Lake Campground on the Park's northwest side (City of San Diego, 2005). This population is also one of the largest for the species in the MSCP. Monitoring of this population began in 2000. Thirteen transects were positioned in the population with the explicit intent to detect changes in the core population area and capture the variability caused by the clumped distribution of the plants and the environment gradient from the stream to the uplands. A total of 334 one meter square quadrats were sequentially located along each transect; in total sampling approximately 5 percent of the population. The population was monitored in 2000, 2001, and 2003.

While the data were collected in 1 meter square sampling units ( $N = 334$ ), the correct way to analyze this data is by transects ( $N = 13$ ). The reason for this is that the positioning of the individual 1 meter square plots, located adjacent to one another along a transect, violates the statistical assumption that the sampling units are independent. This is especially true for species that are rhizomatous or spreading, with plants in one square meter quadrat influencing the number of plants in adjacent square meter quadrats.

The data were analyzed in several ways to assess its ability to detect changes in the population.

The first analysis compared the transect data from 2001 and 2003, the two years when all 13 transects were sampled. Since these were permanent transects, the analysis assesses the change in the number of plants between sampling periods. The 90 percent confidence intervals around the mean change in the number of plants per transect was 4 times the mean ( $35 \pm 142$ ). Thus, while the mean change was positive, the wide confidence intervals show that the change was not different than zero. Clearly the data are highly variable. Seven of the 13 transects had increases in the number of plants, with one increasing by 814 plants. Six of the 13 transects decreased in the number of plants, with one decreasing by 478. This variability could be caused by dramatic changes in the abundance of the species from year to year, but this variability suggests that there could also be a significant non-sampling error caused by not sampling the same places from year to year. If this non-sampling error is present, then it will also influence the other two analyses.

**Changes in the Number of Individuals of *Dudleya variegata* in Belt Transects at Otay Lakes from 2003 to 2005**

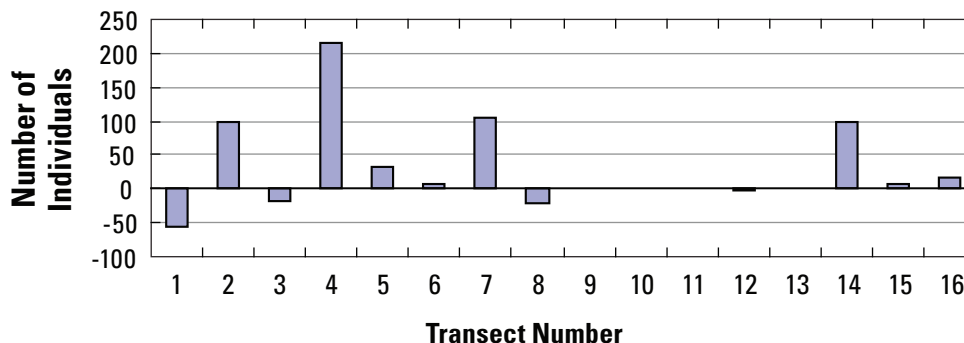

**Figure B2.** Changes in the number of individuals of *Dudleya variegata* in belt transects at Otay Lakes from 2003 to 2005.

The second analysis took the 2001 and 2003 transect data and analyzed them as if they were temporary sampling units, e.g. transects that were repositioned in the population in each sampling period. Permanent sampling units are usually better at detecting change in populations that do not change much in abundance from year to year. Only when there is significant change in a population, from mortality or recruitment, do temporary sampling units start equaling the precision of permanent sampling units. The 90 percent confidence intervals were 46 and 48 percent of the mean for the 2001 and 2003 data, respectively. Using a sample size equation that allows an assessment of confidence intervals over time (number 1 in Elzinga and others, 2001) suggests that 18 transects would detect a 50 percent change. The sample size equation for temporary plots using a statistical test to detect differences between means (sample size equation number 2 in Elzinga and others, 2001), with an alpha of 0.10 and a beta of 0.10, suggests that 30 transects would be needed.

In the third analysis, the data were manipulated to test a different sampling method, systematic sampling with a random start. With this sampling method, data from the individual 1 meter square quadrats can be used. The data from 2001 were

assembled by selecting a random start within the first 3 meters of each transect, then using the count data from every third quadrat. This data manipulation results in an N of 79. Since larger sample sizes usually yield greater precision, this method of sampling may result in a more precise estimate of population size. The data do reflect this, with the 90 percent confidence intervals being 20 percent of the mean. This sampling method could be further improved by redefining the target population to reduce the sampling of areas without plants.

From this analysis, it is recommended that:

- the sampling procedure be assessed for the possible non-sampling error of repositioning the permanent plots in different locations across sampling periods,
- a new sampling design be developed for this population, perhaps using systematic sampling with a random start or frequency sampling, and
- the target population be redefined to eliminate areas that do not have the target species.

## Appendix C. Methodology for Collecting and Recording Voucher Specimens

### The Need for Voucher Specimens

At present, the San Diego Herbarium (the primary collection documenting plant diversity in San Diego County) at the San Diego Natural History Museum has very few voucher specimens for many of the sensitive plant taxa listed under the Multiple Species Conservation Program (MSCP), and none from the exact sites currently being monitored. It is of the utmost importance that every taxon monitored be documented with an herbarium specimen that is deposited and accessioned in an accredited herbarium. Without proper specimen documentation, the presence or correct identity of these sensitive plant taxa may be in doubt. Lists and occurrences of taxa without proper specimen documentation are unverifiable and thus are out of the realm of science. For the vast majority of rare plant localities in San Diego County, no vouchers have been submitted so most of the occurrences have not been scientifically verified. There is a great need for vouchering protocols to be applied to monitored species in order to accurately document their occurrences. It should be noted that not only do these voucher specimens document the populations in the field, but they are also used extensively for many other types of studies such as morphological, anatomical, and ecological analyses. Plus, many herbarium specimens are currently being used for molecular studies involving various DNA techniques in order to better understand biological aspects of species such as taxonomic affinities and population genetics. We hope and encourage that all future work on sensitive plant taxa in San Diego County will endeavor to provide complete voucher specimen documentation.

### *How to Collect and Press Plant Specimens*

Here is some general guidance on how to collect and press museum-quality plant specimens. This information is the basic standard that is used at the San Diego Herbarium, and many other herbaria have very similar guidelines. For a more detailed account of collecting, pressing, and drying plant specimens, and for recording appropriate label information such as locality and plant data, see the San Diego Plant Atlas web site (<http://www.sdplantatlas.org>). Also, refer to Simpson (1997) *Plant Collecting and Documentation Field Notebook*, San Diego State University Herbarium Press, for an excellent explanation of plant collection techniques; as well as Ross (1996). *Herbarium specimens as documents: purposes and general collecting techniques*. *Crossosoma* 22:3–39.

**Before You Collect:** It is legal to collect plants only with the permission of the owner of the property on which they are found. Government agencies that manage lands generally grant permits only to researchers working for an approved

institution, such as a university, or to botanists conducting specific research projects. Private landowners are often willing to allow judicious collecting if asked. Be aware that many “sensitive” species—that is, those that are rare, threatened, or endangered—may be protected by law and may require special permits. Make sure that you have all appropriate permits that are required for access and/or plant collecting before you conduct any collection activities. Do not collect illegally.

**Basic Information Needed:** The date the plant was collected and the location as exactly as possible, including elevation. With today’s online resources and with the availability of hand-held Global Positioning System (GPS) devices, collection localities should have exact geographic coordinates such as latitude/longitude or UTM values. Record anything that the specimen won’t show, for example, the size of the plant, flower color, whether the plant is woody or not, etc. Note what kind of a place the plant was found, for example, in gravel at stream edge, in shade under live oaks, in sidewalk crack outside Walmart. If you bring your plant to an herbarium, we will need all of this information in order to generate the specimen label. If you will be preparing your own labels, they must be printed on acid-free bond paper. For a more detailed account of how to record locality data please see the San Diego Plant Atlas web site (<http://www.sdplantatlas.org>). We recommend recording the field data for each specimen in your field notebook (including the collection number, detailed information about the collecting location, surrounding vegetation, and characteristics of the plant itself). In this manner, the appropriate collection data is recorded in two different places (a private field book and on the newspaper where the specimen is pressed) and has a smaller chance of being lost before the specimen label is generated.

**Field Collecting:** Do not endanger the local population if there are only a few individuals present. In general, use the “1 to 20” rule of thumb: for every one specimen you collect, there should be at least 20 more present in the surrounding population. (For herbs, the rule applies to individual plants; for shrubs and trees, it applies to shoots removed.)

For herbs, dig up at least one whole plant to show roots that can help determine whether the plant is an annual, biennial, or perennial, and identify the type of root (for example, fibrous or tap) or underground stem (for example, corm, bulb, rhizome, etc.). If the plant is small, take the whole thing, roots and all, or even several of them to make a decent voucher specimen. For shrubs, trees, or vines, clip one or more branches. If large, get a branch about 10 inches long, with leaves, flowers, and fruits, if possible.

The ideal plant specimen includes flowers (or other reproductive parts for ferns and non-vascular plants), fruit, leaves, and branches. Reproductive structures are often necessary to positively identify the plant, but it is not always possible to find flowers and fruit on the same plant at the same time. Do the best you can but do not mix together cuttings from different plants (that is, don't take a branch from one plant and then take the fruits or flowers from another). Get enough of a sample to distribute over your 11" by 17" sheet in your plant press (for example, a few branches of larger shrubs, or several small plants that can be distributed over the sheet).

For cacti and succulents, consult an herbarium on specific protocols regarding the preparation and processing of these plants. For the San Diego Herbarium, slice and press the flowers, but place the stems and fruits into a paper bag. Label the bag with the same collection number as the flowers and submit them to herbarium personnel for processing. Similarly, large cones cannot be pressed so they may be placed into a paper bag with the same collection number as the rest of the specimen.

**How to Press a Plant:** Place the specimen in a folded sheet of newspaper. Write the unique collection number, date, and collection locality on the upper outside edge of the newspaper, facing outwards. Arrange the plant so that all parts show, for example, don't get the flowers between layers of leaves. Clean up the specimen (for example, shake off excess soil from the roots and pick off dead leaves, insects, etc.), and if necessary trim or bend into a "V", "N" or "M" shape to neatly fit inside the newspaper and press. Arrange the plants exactly as you want them to appear once they are mounted. Make sure leaves are spread out and not overlapping, that fruits and flowers are showing, and turn over a few leaves

so that the underside of several can be seen. Remember, the voucher will need to be pressed and dried in such a way that all its parts can be studied after the specimen is mounted.

Place the specimens into a plant press. A basic plant press consists of two boards 12" by 18" (half-inch plywood or even thinner will do fine), plus two adjustable straps (or even ropes), and varying numbers of corrugated cardboard ventilators (see [figure C1](#)). Plants are pressed by placing each specimen inside one of the single sheets of folded newspapers, and separating each newspaper sheet with a cardboard ventilator (and blotters or paper towels can also be used to help absorb moisture) so you have an alternating stack of newspaper and cardboard. Place the stack between endboards and strap them tightly or place a heavy weight on top. Put the press where there is good air circulation—it is air, not heat, that dries plants. Don't cook them.

Examine the plants daily and change blotters as needed. It may take days to weeks for the plants to dry completely. Do not put the plants or plant press into a microwave or conventional oven. If required, change the paper every few days to prevent molding, especially for fleshy or succulent plants. Remove plants from the stack when they are dry (stiff and no longer cool to the touch). For the health of those who must handle the dried plants and the specimens, please do not use chemicals of any kind on the plants (for example, use no mothballs, insecticides, etc.). You can kill insects in dried plant specimens by freezing them for three or four days, and keep them pest-free in a tightly-sealed plastic bag.

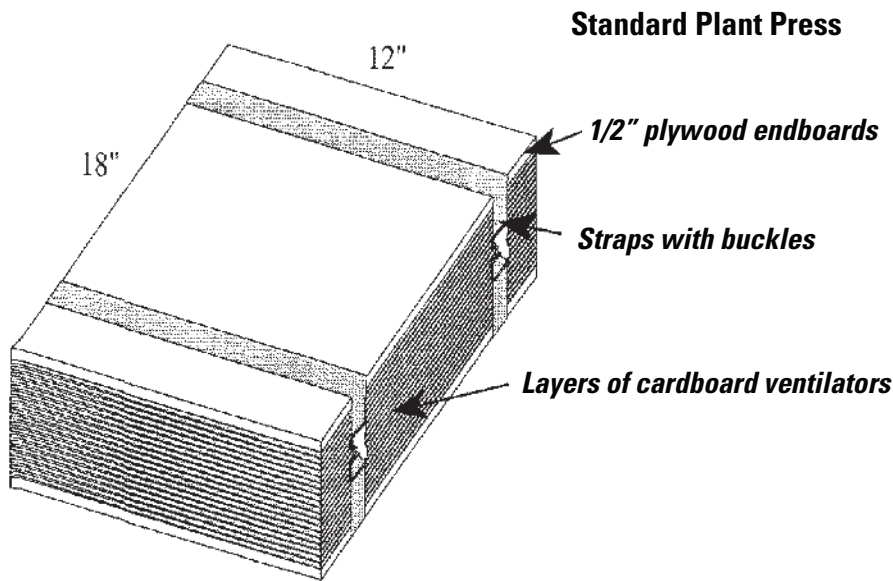

**Figure C1.** Standard plant press (from: Simpson, M.G., 1997 Plant Collecting and Documentation Field Notebook, SDSU Herbarium Press).



## Mounting and Storing Vouchers

Although we recommend submitting the dried, unmounted (in newspaper with basic collection data) specimens to a recognized and accredited herbarium so that they can be mounted and housed in a professional manner, here are some specifics in respect to the supplies needed for mounting and keeping museum-quality vouchers.

**Paper for Mounting:** Herbaria in the United States, and most other countries, use a standard size paper (11½" by 16½") for mounting plants. At the San Diego Herbarium, we use University of California type, a medium-weight acid-free buffered paper.

**Glue:** At the San Diego Herbarium, we use a neutral-pH formulation of PVA (polyvinyl acetate: a white glue like Elmer's) for mounting specimens. We dilute it with water for general mounting and use it full strength for specimens that need to be more firmly glued, such as a woody branch that only touches the sheet in a few spots.

**Sources of Herbarium Supplies:** Two sources of herbarium supplies are Herbarium Supply Co. (800-348-2388) and Pacific Papers (800-676-1151). Other archival quality supplies are available through University Products (800-628-1912 or <http://www.universityproducts.com>).

**Gluing the Specimen:** At the San Diego Herbarium, we usually use the "glass plate" method of mounting plants. A thin layer of glue is spread on an aluminum cookie sheet (traditionally a sheet of glass). If using white glue, some water can be stirred in to dilute it to the consistency you want.

The specimen is first arranged on the paper as it will be glued, and all necessary cleaning and trimming is done. Piece by piece the plant is placed into the glue, making sure all parts have touched down and picked up glue. It is then lifted and blotted on newspaper, and placed on the paper. A paper towel is gently pressed against all parts of the plant to squeeze out and blot up excess glue and to push the plant against the paper.

A thin layer of glue is spread on the back of the label with a palette knife, and the label smoothed into place and blotted.

Another method of gluing is useful for tricky specimens (like wispy grasses, which may gloop together in glue) or recalcitrant parts (such as roots or fuzzy leaves, which often seem glue-repellant). The specimen is arranged on the paper and held in place with weights. Then, working from the roots upward, the weights are removed and glue painted gently on the under side of the plant with a palette knife, and then blotted. The weight is then replaced before moving on to another part of the specimen. The weights are removed before placing the specimen for drying.

**Allowing the Glue to Dry:** The specimen is covered with a sheet of waxed paper so the glue won't stick to anything else. A square of cardboard is placed over the label to hold it flat while it dries. Padding may be added to press down the flatter parts of the specimen if there are bulky parts like stems or fruits. A sheet of cardboard may be placed between specimens to distribute the weight. A board and a weight (we use a rock) top off the stack. The plants are left to dry overnight.

**Storing Specimens:** Although we suggest prompt deposition into a recognized and accredited herbarium, specimens that are well mounted using archival materials will last essentially forever, but only if protected from "agents of destruction" such as molds, light, and insects. They should be stored in a tightly-sealed box or cabinet. No pesticides need be used if no insects can get into this space.

Insects can be killed by freezing the specimens (after the plants are dried, but either before or after mounting) at a temperature of -10° F. for three days or longer, preferably in a freezer that is not self-defrosting (since these have cycles of warm temperatures). Specimens should be placed in a plastic bag first, and left in the bag until they reach room temperature after coming out of the freezer. Everything should be frozen before being placed in your storage space, and if an infestation is found, everything should be removed and frozen, and the space thoroughly cleaned before replacing the specimens.

This page intentionally left blank.

## Appendix D. A Practical Guide for Development of San Diego Multiple Species Conservation Program (MSCP) Rare Plant Monitoring and Management Plans

**Table D1.** Steps in MSCP Monitoring and Management Plan Development.

### CHARACTERIZATION MODULE

- Identify any additional Adaptive Management Working Group members for this species—that is, experts who know the species and populations.
- Conduct background research to gather information on the species and populations (ecology, biology, maps, consult herbaria, identify jurisdictional responsibilities, experiments on this and related taxa, past monitoring results, past management, MSCP priorities).
- Identify the Management Units for the species:
- Identify the Management Units for the species:

A Management Unit is:

A practical unit that can be effectively managed as a whole.

The management unit is a grouping of individuals on the landscape that is ecologically distinct and functions independently of other groups. The management unit is sometimes, but not necessarily, equivalent to a biological population or sub-population.

- Characterize each management unit, based on field observations of attributes such as the number of plants, proportion reproductive, size of area occupied, vegetation composition, apparent threats, landscape context, past management (see Appendix D for Management Unit Characterization Form).
- Develop an ecological profile for the species using the background literature and expert knowledge; include uncertainties about life history or ecology that may need to be answered in order to develop conservation goals and management strategies.

### MANAGEMENT PLANNING MODULE

- Articulate desired future conditions and goals and objectives, for the species and for the management units; in terms of Abundance, Extent, Resilience, and Persistence, at both short and long time-frames.
- Identify threats that may prevent or slow progress toward the desired future conditions.
- Clearly articulate the Key Management Questions at both the species and management unit levels.
- Discuss management tools that may be effective in achieving the goals and objectives for each management unit.
- Identify the phase of management envisioned for the management unit (Protection, Restoration and Recovery, or Preservation).
- Determine what approach will be taken to management (Population Creation, Population Enhancement, or Maintenance of Habitat Quality).
- Determine which management regime will be applied to the unit (Experimental, Guided, Intensive Care, or Quiescent).
- Write a clear management action plan and schedule for the management units, relate to conservation goals for the species across the MSCP.

### MONITORING DESIGN MODULE

- Articulate the Key Management Question to be addressed with the monitoring.
- Identify the type of monitoring design appropriate to the situation (Effectiveness, Validation, Status).
- Assess previous monitoring.
- For effectiveness or validation monitoring, identify the sampling objective in terms of precision and power, time-frame, expected outcomes, response variables.
- Develop a sample design, using the seven-step process.
- Design the appropriate databases for monitoring data collection, archival, analyses, and progress reporting (include both qualitative or quantitative data and spatial databases, and metadata).
- List the evaluation process for the monitoring outcomes, including the vision for next steps and adaptation of the Plan based on monitoring outcomes.

### SCHEDULE AND BUDGET

- Develop a schedule and budget for Monitoring and Management Plan implementation.

**Table D2.** Questionnaire for Monitoring and Management Planning.

---

**Species-level questions**

---

Ecological questions

What is the MSCP priority of the species?

What is the taxonomy and distribution of the species?

What is known about the biology and ecology of the species?

What biological and ecological questions need to be addressed for conservation - uncertainties? (Note: if an uncertainty is posed, but there does not seem to be any need to address it in for purposes of management, mention it as an uncertainty, and then indicate why it does not need to be addressed in this conservation strategy.)

What are the desired ecological conditions for the species (short and long-term)?

---

Identifying goals and objectives for the species

<b>GOALS</b>	<b>SPECIES OBJECTIVES</b>	
	<b>Short-term</b>	<b>Long-term</b>
Abundance		
Extent		
Resilience		
Persistence		

Are there threats affecting several populations that roll up to threats for the species?

What are the key management questions for the species?

What are the basic management units making up this species in the MSCP?

Units:

- Metapopulations
- Populations
- Management clusters/Management units

Sources: published papers, unpublished documents, expert knowledge, natural history information

# Population or Management Unit-Level Questions

## Ecological questions

Priority within the MSCP – how important is this unit to persistence of the species?

Characterize the management unit—Characterization of each Management Unit:

- Describe
- Map
- Census
- Habitat
- Vegetation
- Previous management
- Threats
- Vouchers

What biological and ecological questions need to be addressed for conservation—uncertainties?

What threats are decreasing the viability of the population?

What are the desired ecological conditions for the population (short- and long-term)?

Identifying goals and objectives for the Management Unit

GOALS	MANAGEMENT UNIT OBJECTIVES	
	Short-term	Long-term
Abundance		
Extent		
Resilience		
Persistence		

What threats are keeping the desired ecological condition from being reached?

What are the key management questions for each population?

Are there threats at another population that can be addressed with experiments at this site?

## Management questions

What phase of management is targeted for this management unit? (Phases: Protection, Restoration and Recovery, Preservation)

What approach will be taken to management?

Approaches:

- Population creation
- Population enhancement
- Habitat quality maintenance

What management regimes will be applied?

- Management regimes:
  - Experimental
  - Manipulated (managed)
  - Intensive care
  - Quiescent

## 48 San Diego Multiple Species Conservation Program (MSCP) Rare Plant Monitoring Review and Revision

What tools are available for management?

What management actions are proposed to maintain, enhance, or create/establish populations?

What policy needs to be considered?

### Monitoring questions

What key management question is being addressed with this monitoring?

If status monitoring, what population or habitat attributes need to be evaluated?

What is the response variable – what outcome is expected?

What is the time-frame of this monitoring (short- or long-term)?

How will results be evaluated (what are the criteria that demonstrate success?)

Sample design – 7-step process

Database design

Schedule and budget

**Table D3.** Monitoring and Management Plan Template.

<b>Monitoring and Management Plan for (Species): Species Information</b>	
Ecological Characterization	
MSCP Species Priority	
Taxonomy and Distribution	
Biology and Ecology	
Uncertainties	
Management Planning	
MSCP-Wide Conservation Goals	
Desired Ecological Conditions for the Species (verbal description)	

Species-Level Desired Ecological Conditions for \_\_\_\_\_

SPECIES GOALS	SPECIES OBJECTIVES	
	Short-term	Long-term
Abundance		
Extent		
Resilience		
Persistence		

Threat assessment

Threats

Key Management Questions

Management tools

Identification of Management Units

Management Units—Table

Sources of Information:

List (for example, published papers, unpublished documents, expert knowledge, natural history information)

Attach publication copies and notes of conversations

## Monitoring and Management Plan for: (*species*) Management Unit (*name*)

### Ecological Characterization

#### Ecological profile

Priority within the MSCP  
 Management Unit Characterization  
 Uncertainties

### Management Planning

#### Management Unit Conservation Goals

Desired Ecological Conditions for the Unit (verbal description)

Desired Ecological Conditions for Management Unit

MGT UNIT GOALS	MANAGEMENT UNIT OBJECTIVES	
	Short-term	Long-term
Abundance		
Extent		
Resilience		
Persistence		

#### Threat assessment

Threats  
 Threats at another unit that may be addressed with experiments at this site

#### Key Management Questions

Key questions that need to be answered with monitoring

#### Management Planning

Tools  
 Management Phase (Protection, Restoration and Recovery, or Preservation)  
 Management Approach (Population Creation, Population Enhancement, or Maintenance of Habitat Quality)  
 Management Regime (Experimental, Guided, Intensive Care, or Quiescent)  
 Policy Needs  
 Management Actions



## Monitoring Design

### Key Management Question to be addressed

Type of monitoring design (Effectiveness, Validation, Status)

Assessment of previous monitoring efforts

Sampling objective (precision or power – depending on whether it is a status or trend objective)

Response variable/Expected outcome

Time frame

Sample Design Decisions

- Target population (population making inference to)
- Biology - how it affects sampling units
- Sampling units - size and shape of sampling units
- Positioning of sampling units in the target population
- Permanent or temporary sampling units
- Number of sampling units
- Frequency of sampling

Database design

Data sheet design

Evaluation criteria and process

## Schedule And Budget

Timeline/Schedule

Budget

Table D4. Management Unit Characterization Form

---

**Multiple Species Conservation Program (MSCP)**

---

Rare Plant Field Survey Form

---

*Scientific Name:* \_\_\_\_\_ *Common Name:* \_\_\_\_\_

*Site Name:* \_\_\_\_\_ *Management Unit #:* \_\_\_\_\_

*Date:* \_\_\_\_\_ *Management Regime:* \_\_\_\_\_

*Surveyors and Affiliation/Agency:*

Species Found?

If not, why (if reason known or suspected)?

Total No. Individuals:

Population/Subpopulation Area:

---

**I. Observation Area/Management Unit Location**

---

Accuracy of Coordinates/GPS Error: +/-

Observation Location: State Plane (feet) UTM

---

**II. General Habitat Description And Threats Assessment**

---

Vegetation Community:

Landowner/Manager:

Incidental rare/sensitive plant or animal sightings on this date at this site:

Overall Site Quality:\*

Use Trudgen & Keighery Vegetation Condition Scale Descriptions (see form instructions)

Surrounding land use:

Disturbance history:

Disturbances and/or threats (be specific, include extent of disturbance or percent cover of disturbance if possible):

Management Recommendation/s:

---

### III. Associated Species

List dominant, subdominant, and invasive species in/near target species observation area/management unit.

*Form: Tree=T, Shrub=S, Herb/Graminoid=H; 'Cvr' = % cover of species*

### IV. Site Photomonitoring

Camera type:

Location [State Plane (ft)], Direction (facing), Height (Use Tripod), Camera Angle

File location/s:

Location [State Plane (ft)], Direction (facing), Height (Use Tripod), Camera Angle

File location/s:

Collections (if not collected previously)?

If yes:

Collection Number

Museum/Herbarium (submit to SDNHM unless otherwise noted)

### V. Adaptive Management Recommendations/Field Notes

Adaptive Management Experiment Recommendations:

Other Field Notes/Comments (continue on back if needed):

---

This page intentionally left blank.

## Appendix E1. Monitoring and Management Plan Draft Example: Monitoring and Management Plan for *Ambrosia Pumila*; Species Information

### Species Ecological Characterization

#### MSCP Species Priority

Regan and others. At Risk Group 1, (Ogden Priority 2)  
(FE G1 S1.1 List 1B)

*Note: Global ranking does not take into account Mexico distributions*

#### Taxonomy and Distribution

San Diego ambrosia (*Ambrosia pumila*) is a perennial, rhizomatous member of the sunflower family (Asteraceae). It has a United States (U.S.) distribution in coastal San Diego County and western Riverside County (Hickman, 1993), ranging about 500 miles south to the dry lake bed of Lake Chapala, Baja, Mexico. San Diego ambrosia has become more rare in the U.S. as land development has taken over habitat. Forty-nine U.S. populations were known from historic records, but there were 12 known populations in 2002, when the species was listed as endangered (U.S. Fish and Wildlife Service, 2002). [Figure E-1](#) shows its distribution within the MSCP.

#### Biology/Ecology

San Diego ambrosia (*Ambrosia pumila*) is a perennial herb, reproducing mainly by vegetative resprouting from underground rhizomes. Although it produces flowers, it has not been known to produce seeds within the MSCP populations (U.S. Fish and Wildlife Service, 2002; K. Greer, City of San Diego, oral commun., 2006; and C. Winchell, U.S. Fish and Wildlife Service, oral commun., 2006). Within the genus *Ambrosia*, there is a high prevalence of self-fertile and self-pollinated species with low genetic diversity within populations (U.S. Fish and Wildlife Service, 2002). Recent studies indicate that there is a high degree of genetic diversity within three sampled San Diego ambrosia populations, hinting that sexual reproduction must have occurred at times in the past (Friar, 2005). Studies of genetic clonal structure (McGlaughlin and Friar, 2006) indicate that multiple genets occur in each population, with genotypes spatially intermingled at scales of 0.25 m<sup>2</sup> or less. No genotypes are shared among populations. Genet size is generally under 0.59 m<sup>2</sup>, and ramets appear small, with a mean clone size of 9.10 ramets per genet over the three populations sampled.

San Diego ambrosia appears to be a poor competitor, a factor limiting its distribution to places periodically scoured by flooding or otherwise inhospitable to other plants. The fact that plants are found on soils as diverse as alluvial sand and dry lake bed clays indicates that San Diego ambrosia may tolerate a range of soils as long as other plants are sparse.

Historical habitat in the northern part of the range is creek beds, seasonally dry drainages, and terraces on sandy alluvium (U.S. Fish and Wildlife Service, 2002). Within the Multiple Species Conservation Program (MSCP) it grows in degraded riparian grassland and coastal sage scrub communities within a matrix of alien annual grasses (*Bromus sp.*, *Vulpia sp.*, *Avena sp.*), *Brassica nigra*, *Hirschfeldia incana*, *Erodium sp.*; and the natives *Eremocarpus setigerus*, *Baccharis salicifolia*, *B. sarathroides*, and an occasional *Artemisia californica* (City of San Diego, 2006; U.S. Fish and Wildlife Service (USFWS), San Diego National Wildlife Refuge, unpublished data 2006). In Baja, San Diego ambrosia is found in dry lake beds on clay soils with thin vegetation. There have been observations that the ambrosia does well in sites with light disturbance where the vegetation is opened up (U.S. Fish and Wildlife Service, 2002). Thus, it appears to be a poor competitor requiring sites with sparse vegetation but tolerant of a variety of soils. Threats to populations identified in the Federal listing package, and from field observations, are associated with land use (habitat loss, trampling), and altered physical environments (fire regime, altered hydrology, pollution), and changed biological environments (herbivory, invasives).

San Diego ambrosia was listed because development was fragmenting and removing populations, and because trampling, soil compaction, altered fire and hydrologic regimes, and grazing were degrading the remaining habitats and killing plants. Now, most U.S. populations are on lands that are or will be conserved in the San Diego and Riverside MSCPs, where habitats can be protected by fencing to redirect traffic and eliminate grazing. Still, the ambrosia is growing in places that have been thoroughly changed by the ways we use the land—both through ranching in the past and urban development and increasing recreational pressure now. All of the sites in the MSCP are invaded by non-native annual grasses, along with the weeds *Brassica nigra* and *Hirschfeldia incana*. These places are probably the remnant remains of grasslands at the riparian fringe, where sheet wash or flood scouring periodically opened up the vegetation.

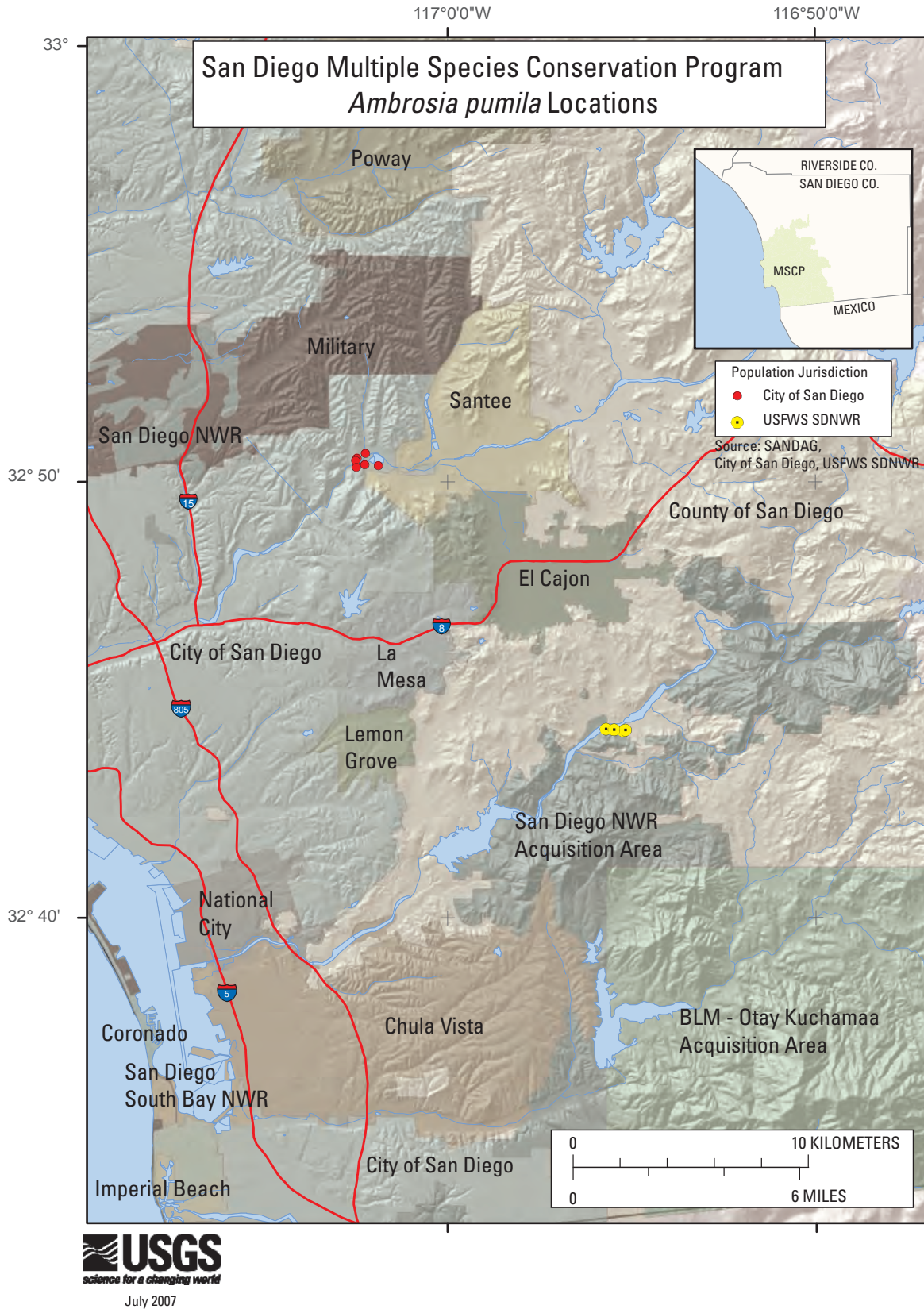

Figure E1. *Ambrosia pumila* locations in the San Diego Multiple Species Conservation Program (MSCP).

Several factors impinge on ambrosia habitats now, resulting in populations with fewer plants than observed in the past, occupying smaller areas of the habitat. These factors are related to trampling and current crowding and competition from other plants. Root predation by gophers was the major cause of mortality in a restoration planting (Johnson and others, 1999), but this has not been observed in natural populations (John Martin, U.S. Fish and Wildlife Service, oral commun., 2006; and M. Johnson, City of San Diego, oral commun., 2006). Invasion of habitats by non-native annual and perennial plants is seen by local experts as the greatest threat to the species. Past and present disturbance, the elimination of flood scouring, and nutrient enrichment through pollution and the past cattle grazing all contribute to the invasion and type conversion to alien annual grassland. Since genetic studies show that there is low genetic diversity among populations (McGlaughlin and Friar, 2006), a conservation priority should be to preserve as many populations across the species range as possible.

## Uncertainties

### 1. Lack Of Apparent Seed Set:

San Diego ambrosia has not been observed to produce seeds in MSCP populations. However, recent genetic studies (Friar, 2005; McGlaughlin and Friar, 2006) show high levels of genetic diversity within populations. Such high genetic diversity arises from sexual reproduction, indicating that the species has produced seed in the past. It is uncertain whether this species produces seed only infrequently as a natural strategy, or whether it has lost the capacity for sexual reproduction through intrinsic or extrinsic means. The species is wind pollinated, and there has been the suggestion that crowding by other plants in the habitats may prevent effective pollination (U.S. Fish and Wildlife Service, 2002; McGlaughlin and Friar, 2006). Encouraging seed set and thus increasing genetic diversity could be a long-term goal for San Diego ambrosia. However, this does not appear to be a key management question or concern for MSCP populations, since research on this question is not likely to yield immediate management results, and is generally beyond the scope of agency monitoring. Seed set research should be encouraged by an outside party. This is not a key management question.

### 2. Requires Open Sites/Disturbance Adapted/Poor Competitor:

Several lines of evidence lead to the conclusion that San Diego ambrosia is a poor competitor with other plants, and for that reason was historically and naturally restricted to habitats with low cover. These habitats included seasonally dry creek beds and terraces subject to intermittent flood scouring and clay pan soils tolerated by few other species. In San Diego County, ambrosia now occurs on creek bed and terrace habitats invaded by alien annual grassland. We do not know whether ambrosia populations would be larger if the natural hydrologic flooding regime that periodically cleared vegetation remained intact on these sites. Populations growing in open vegetation on dry lakebed clays near Catavania, Baja California, Mexico, appear more robust than those in San Diego County. Clearing of annual grass competitors may be a tool for increasing San Diego ambrosia density within populations. This is not the best long-term sustainable strategy because it requires constant management. The long-term goal would be to restore periodic flood scouring. Absent that, if clearing is successful, we need to find ways to simulate a flooding regime, such as mowing or burning on an erratic schedule like a flood regime.

## Species Management Planning

### MSCP-Wide Conservation Goals

Species level conservation goal:

Enhance all eight existing management units:

increase numbers of ramets within each management unit (MU) and increase spatial extent;

populations resilient in the face of stochasticity, persistent over many years.

Desired Ecological Conditions for *Ambrosia pumila*:

Eight management units with minimum of 2,000 plants each within the MSCP

Species-level Desired Ecological Conditions

SPECIES GOALS	SPECIES OBJECTIVES	
	Short-term	Long-term
Abundance	Increasing	>1,000 ramets per MU
Extent	Expanding	Present in all 8 locations
Resilience	Stabilize small MUs	Resilient to fire, flooding
Persistence	Prevent extirpation at small MUs	Present as vegetative ramets annually

## Threat Assessment

- Land use: habitat fragmentation and loss, mowing and discing for fire protection, trampling and soil compaction by humans, vehicles, horses
- Physical threats: altered fire regime, altered hydrology, pollution
- Biological: herbivory (cattle and sheep in the past, gophers), competition from invasive plants, failure to produce seed
- Expert opinion: Invasives constitute the highest threat, now that several populations are protected in the MSCP. Additionally, foot and horse traffic threaten several of the smallest occurrences. Failure to produce viable seed in most years is a potential threat to long-term persistence and resilience, but is not the most immediate short-term threat to the species. Seed viability research should be done, but it is beyond the scope of immediate management needs.

## Key Management Questions

Posed as questions:

- (1) Does the presence of annual grass prevent/hinder the vegetative spread of San Diego ambrosia?
- (2) Does the presence of grass thatch and litter prevent vegetative recruitment?
- (3) Can vegetative recruitment be improved with the removal of grass or grass thatch?

Posed as an hypothesis:

Grasses compete with San Diego ambrosia, limiting population growth (increases in cover, stem density, spread to adjacent sites) within and at the edges of population boundaries. Removal of standing crops of annual grasses will result in an increase in the ambrosia cover. Since the species reproduces vegetatively, thatch does not hinder spread, so that thatch removal will have little effect on ambrosia.

## Management Tools

### 1. Transplanting vegetative cuttings:

San Diego ambrosia was transplanted from vegetative cuttings in a reintroduction experiment at Mission Trails State Park (Johnson and others, 1999). These plants persist today (M. Johnson, City of San Diego, oral commun., 2006) San Diego Gas and Electric has salvaged plants from a take site, transplanted them to pots, and is holding them for out-planting to a mitigation site (J. Buegge, U.S. Fish and Wildlife Service, oral commun., 2006).

### 2. Reduction of grass cover:

An area disked for a fire break in 2003 supported San Diego ambrosia in 2005 (John Martin, U.S. Fish and Wildlife Service, oral commun., 2006); in this area grass and black mustard density is lower than in nearby sites not disked (Par 4 Management Unit 1). Sites at Par 4 cleared to create burrowing owl nest sites were colonized by San Diego ambrosia, although they were not used (disturbed) by owls (C. Winchell, U.S. Fish and Wildlife Service, oral commun., 2006.)

## Identification of Management Units

All known ambrosia management units within the MSCP are identified in [table E1](#).

## Responsibilities

Adaptive management experiments/hypothesis testing shall be the collective responsibility of all agencies with oversight of *Ambrosia pumila* management units, regardless of experimental population location. It is recommended that all agencies be as cooperative as possible in planning, conducting, and analyzing adaptive management experimental testing.

Management implementation will be the responsibility of individual land owners/managers responsible for management of the respective areas/management units.



**Table E1.** San Diego ambrosia (*Ambrosia pumila*) Management Units within the San Diego Multiple Species Conservation Program.

[Parcel C discussed in U.S. Fish and Wildlife Service final rule, 2002. Area to be calculated from Global Positioning System and field notes. USFWS\_SD, U.S. Fish and Wildlife Service San Diego. na, not available]

Administrative area	Management unit	Number of plants	Area 2	Proposed management regime	Management responsibility
Mission Trails (P16)	Parcel C6	3600–9000		Experimental	City of San Diego
	Unit 2			Quiescent	
	Unit 3			Quiescent	
	Unit 4			Quiescent	
	Reintroduction site			Quiescent	
Par 4	Unit 1	~2000		Quiescent	USFWS_SD Refuge
	Unit 2	~2000		Quiescent	
Sweetwater Bridge	Horse trail/concrete brow ditch	~20		Quiescent	USFWS_SD Refuge
	South (downstream) of Steele Canyon Bridge	~20		Quiescent	
Site 49	3 patches	~20 ea		na	Private

### Sources of Information:

List of published papers, unpublished documents, expert knowledge, natural history information

California Native Plant Society, Inventory of rare and endangered plants. Accessed 01/2006. <http://www.cnpsd.org/ambrosia99.html>

City of San Diego, 2000, Summary of monitoring results for *ambrosia pumila*: San Diego, California.

City of San Diego, 2001, Summary of monitoring results for *ambrosia pumila*: San Diego, California.

City of San Diego, 2003, Summary of monitoring results for *ambrosia pumila*: San Diego, California.

City of San Diego, 2005, City of San Diego rare plant monitoring: Field monitoring methods: San Diego, California.

City of San Diego, 2006, Rare plant monitoring—Field monitoring methods: San Diego, California, Planning Department, Multiple Species Conservation Program Division, 60 p.

County of San Diego Multiple Species Conservation Program, 2002, Sensitive plant monitoring final Report: Prepared for California Department of Fish and Game.

Dudek & Associates, 2000, City of San Diego Mission Trails Regional Park San Diego *Ambrosia* Management Plan: Prepared for City of San Diego, California

## 60 San Diego Multiple Species Conservation Program (MSCP) Rare Plant Monitoring Review and Revision

- Friar, E, 2005, Conservation genetics as a tool for scientists and managers: Fullerton, California Presentation at 2005 Southern California Botanists Symposium.
- Griffin, D.J., 2003, DRAFT 2003 Report of MSCP covered species at San Diego National Wildlife Refuge: Prepared for US Fish and Wildlife Service, Carlsbad, California.
- Hickman, J.C., ed., 1993, The Jepson manual higher plants of California: Berkeley and Los Angeles, California, University of California Press, 1400 p.
- McGlaughlin, M.E., and Friar, E.A., 2006, Clonality in the endangered *Ambrosia pumila* (Asteraceae) inferred from RAPD markers; implications for conservation and management: Conservation Genetics DOI 10.1007/s10592-006-9171-4. 12 p.
- McMillan Biological Consulting, and Conservation Biology Institute, 2002, 2001 MSCP Rare Plant Survey and Monitoring Report: Prepared for the City of San Diego, California.
- Regan, Helen, Lauren Hierl, Janet Franklin, Doug Deutschman, 2006, Grouping and prioritizing the MSCP covered species: San Diego State University, San Diego, California, Technical report to California Department of Fish and Game.
- Reiser, C.H., 1994, Rare plants of San Diego County: Unpublished: San Diego, California. Aquafir Press. Available online at: <http://sandiego.sierraclub.org/rareplants/008.html>
- Ross, T.S., 1996, Herbarium specimens as documents: Purposes and general collecting techniques: Crossosoma, v. 22, p. 3–39.
- Soil Ecology Restoration Group (Johnson, J., D. Bainbridge, J. Janssen, and D. Truesdale), 1999, *Ambrosia pumila*: monitoring, outplanting and salvage. <http://www.serg.sdsu.edu/SERG/restorationproj/chaparraland/ambrosia.html>
- U.S. Fish and Wildlife Service, 2000, Endangered and threatened wildlife and plants; Reopening of comment period on proposed endangered status for *Ambrosia pumila* (San Diego Ambrosia): Federal Register, v. 65, no. 62, 16869–16870.
- U.S. Fish and Wildlife Service, 2002, Determination of endangered status for *Ambrosia pumila* (San Diego ambrosia) from southern California: Federal Register, v. 67, no. 127, 44372–44382.
- U.S. Fish and Wildlife Service, 2006, Draft *Ambrosia pumila* technical report: Jamul, California, San Diego National Wildlife Refuge.

## Appendix E2. Monitoring and Management Plan for San Diego ambrosia (*Ambrosia pumila*)—Management Unit Parcel C6, Mission Trails Regional Park, City of San Diego

### Management Unit Ecological Characterization

Priority within the MSCP occurrence of the species—High: this is the largest occurrence within the MSCP

Management Unit Characterization—needs to be done, see City of San Diego, 2005, for general description and location (UTMs)

Uncertainties—Conditions here should be improving since establishment of split-rail fencing in 1998. It is unclear whether ambrosia cover or density can be increased within the population boundary, or expanded outside of the boundary with alien grass removal.

### Management Unit Management Planning

#### Management Unit Conservation Goals

Desired Ecological Conditions for the Unit: A population with approximately 10,000 ramets, occupying the current area and surrounding unoccupied habitat. Population resilient to drought and persistent for decades.

Desired Ecological Conditions for Management Unit

MGT UNIT- GOALS	MANAGEMENT UNIT OBJECTIVES	
	Short-term	Long-term
Abundance	3,000–9,000 ramets	10,000 ramets
Extent	Current occupied habitat	All available habitat in MU
Resilience	Resilient to drought and fire	Resilient to drought and fire
Persistence	Vegetative plants	Vegetative plants
	Present annually	Present annually, viable seed production evident

### Threat Assessment

Threats: This site has been protected from trampling, ORV use, and horseback riding through fence construction; it has likely benefited from the conversion from a ranch to a conservation area. Greatest threats now appear to be soil compaction, and crowding and competition from alien annual grasses (*Bromus sp.*, *Vulpia sp.*, *Avena sp.*). Ambrosia ramets are present in patches at this site, in places with coarse-grained soil and open vegetation.

Threats at another unit that may be addressed with experiments at this site: Annual grass competition is prevalent at all other sites.

### Key Management Questions

Key questions that need to be answered with monitoring:

- (1) Does the presence of annual grass prevent/hinder the vegetative spread of San Diego ambrosia?
- (2) Does the presence of grass thatch and litter prevent vegetative recruitment?
- (3) Can vegetative recruitment be improved with the removal of grass or grass thatch?

## Management Planning

Tools: annual grass removal by hand-weeding in small plots, raking or burning over larger areas if plot monitoring shows positive results.

Management Phase: Protection and Restoration

Management Approach: Population Enhancement and Improvement of habitat quality

Management Regime: Experimental

Policy Needs: Monitoring is required through the MSCP

Management Actions: Continue protection with the maintenance of the fence, ranger patrols, and education programs. Develop a brochure for public education.

## III. Management Unit Monitoring Design

Key Management Question to be addressed: Can vegetative recruitment be improved with the removal of grass culms?

Type of monitoring design—Effectiveness

Assessments of previous monitoring efforts are shown in tables [E2](#), [E3](#), and [E4](#).

**Table E2.** City of San Diego monitoring metadata for *Ambrosia pumila* quantitative transect monitoring at parcel C6.

[AmPu, *Ambrosia pumila*; MTRP, Mission Trails Regional Park; P/A, Presence/Absence, check site to see whether taxon is present, or absent. m<sup>2</sup>, square meter; —, no data]

Species	Sub-population/ sample site	Date	Year	Methods	Notes
AmPu	—	—	1999		No data as listed in 2005 methods document. May have just been initial mapping of populations
AmPu	MTRP	07/25/2000	2000	1 m <sup>2</sup> plots on transects	
AmPu	MTRP	07/09/2001	2001		For transects 1–6 in 2001, data on 7/9 were omitted from City's final reports. While entered in spreadsheet, did not include in total adult on 1-QdData spreadsheet.
AmPu	—	—	2002		Not monitored.
AmPu	MTRP	08/15/2003	2003	1 m <sup>2</sup> plots on transects	
AmPu	—	—	2004		Not monitored.
AmPu	—	07/14/2005	2005	Qualitative	Ambrosia flowered much earlier than in previous years, possibly due to early and heavy rains.
				P/A	

**Table E3.** City of San Diego summary—Plant density and population size.

[m<sup>2</sup>, square meter]

Sample date	Year	Number of individuals	Area sampled (m <sup>2</sup> )	Density (number/m <sup>2</sup> )	Population area	Population size
07/25/2000	2000	3,626	207	17.5	6,954.4	121,702
07/09/2001	2001	8,542	353	24.2	7,372	178,402
08/15/2003	2003	90,011	334	26.9	7,372	198,307

**Table E4.** City of San Diego summary—Total plants sampled.

Sample date	N (number transect)	Total number plants			
		Sum	Mean	CalcStDev	CalcVar
7/25/2000	13	3,626	278.9	693.3	480,730.2
7/9/2001	13	8,542	657.1	617.2	380,943.7
8/15/2003	13	9,001	692.4	677.6	459,152.4

## Monitoring data analysis for San Diego ambrosia (*Ambrosia pumila*) at Mission Trails Regional Park (reproduced from Appendix B)

San Diego ambrosia, a perennial herb, occurs in several locations within Mission Trails Regional Park, with the largest population adjacent to the Kumeyaay Lake Campground on the Park's northwest side (City of San Diego, 2005). This population is also one of the largest for the species in the MSCP. Monitoring of this population began in 2000. Thirteen transects were positioned in the population with the explicit intent to detect changes in the core population area and capture the variability caused by the clumped distribution of the plants and the environment gradient from the stream to the uplands. A total of 334 one meter square quadrats were sequentially located along each transect; in total sampling approximately 5 percent of the population. The population was monitored in 2000, 2001 and 2003.

While the data were collected in one meter square sampling units ( $N = 334$ ), the correct way to analyze this data is by transects ( $N = 13$ ). The reason for this is that the positioning of the individual one meter square plots, located adjacent to one another along a transect, violates the statistical assumption that the sampling units are independent. This is especially true for species that are rhizomatous or spreading, with plants in one square meter quadrat influencing the number of plants in adjacent square meter quadrats.

The data were analyzed in several ways to assess its ability to detect changes in the population.

The first analysis compared the transect data from 2001 and 2003, the two years when all 13 transects were sampled. Since these were permanent transects, the analysis assesses the change in the number of plants between sampling periods. The 90 percent confidence intervals around the mean change in the number of plants per transect was 4 times the mean ( $35 \pm 142$ ). Thus, while the mean change was positive, the wide confidence intervals show that the change was not different than zero. Clearly the data is highly variable. Seven of the 13 transects had increases in the number of plants, with one increasing by 814 plants. Six of the 13 transects decreased in the number of plants, with one decreasing by 478. This variability could be caused by dramatic changes in the abundance of the species from year to year, but this variability suggests that there could also be a significant non-sampling error caused by not sampling the same places from year to year. If this non-sampling error is present, then it will also influence the other two analyses.

The second analysis took the 2001 and 2003 transect data and analyzed them as if they were temporary sampling units, for example, transects that were repositioned in the population in each sampling periods. Permanent sampling units are usually better at detecting change in populations that do not change much in abundance from year to year. Only when there is significant change in a population, from mortality or recruitment, do temporary sampling units start equaling the precision of permanent sampling units. The 90 percent confidence intervals were 46 and 48 percent of the mean for the 2001 and 2003 data, respectively. Using a sample size equation that allows an assessment of confidence intervals over time (number 1 in Elzinga and others, 2001) suggests that 18 transects would detect a 50 percent change. The sample size equation for temporary plots using a statistical test to detect differences between means (sample size equation number 2 in Elzinga and others, 2001), with an alpha of 0.10 and a beta of 0.10, suggests that 30 transects would be needed.

In the third analysis, the data were manipulated to test a different sampling method, systematic sampling with a random start. With this sampling method, data from the individual one meter square quadrats can be used. The data from 2001 were assembled by selecting a random start within the first three meters of each transect, then using the count data from every third quadrat. This data manipulation results in an  $N$  of 79. Since larger sample sizes usually yield greater precision, this method of sampling may result in a more precise estimate of population size. The data do reflect this, with the 90 percent confidence intervals being 20 percent of the mean. This sampling method could be further improved by redefining the target population to reduce the sampling of areas without plants.

From this analysis, it is recommended that:

- the sampling procedure be assessed for the possible non-sampling error of repositioning the permanent plots in different locations across sampling periods;
- a new sampling design be developed for this population, perhaps using systematic sampling with a random start or frequency sampling; and
- the target population be redefined to eliminate areas that do not have the target species.

Sampling objective—Detect an increase in mean San Diego ambrosia ramet cover and density at a 90 percent confidence level, within weeded plots over un-weeded control plots, through a 3-year sample period.

Response variable—San Diego ambrosia ramet cover and density

Expected outcome—Increase in cover and density

Time frame—3 years

#### Sample Design Decisions

- Target population (population making inference to)
- Biology - how it affects sampling units
- Sampling units - size and shape of sampling units
- Positioning of sampling units in the target population
- Permanent or temporary sampling units
- Number of sampling units
- Frequency of sampling

Database design—To be decided by AMWG

Data sheet design—To be decided by AMWG

Evaluation criteria and process—Evaluate results annually; after 3 years evaluate whether desired increases have occurred.

If so, investigate ways to apply this treatment more widely at Parcel C6 and at Par 4. Develop ways to apply weeding to benefit the other, small, and much more at-risk sites at Sweetwater Bridge. If desired increases have not occurred, evaluate possible causes (for example, weather, herbivory, soils effects, thick thatch), and develop follow-up experiments designed to expand the population.

## Schedule and Budget

Timeline/Schedule—To be decided by AMWG

Budget—To be decided by AMWG

This page intentionally left blank.



## Appendix E3. Management Unit Plan

### **Monitoring and Management Plan for San Diego ambrosia (*Ambrosia pumila*): Mission Trails Management Units 2, 3 4, and reintroduction site; Par 4 Management Units 1 and 2; and Sweetwater Bridge Sites at Horse Trail and South of Steele Canyon Bridge**

[The Adaptive Management Working Group (AMWG) should develop these Plans. Following are general observations and recommendations].

#### **City of San Diego:**

##### **Mission Trails Management Units 2, 3 4, and the Reintroduction Site**

These Management Units (MU) need to be characterized before management and monitoring plans can be made. They are much smaller than the Parcel C6 MU, and could probably benefit from any positive results of weeding, if effectiveness monitoring at Parcel C6 indicates that management treatment is beneficial. If MU characterization shows that trampling still affects the units, fencing or other measures to direct traffic away from them might be beneficial. We recommend a Quiescent management regime for these sites, with a simple presence/absence or census type status monitoring to check on population condition. The MU characterization can serve as a baseline. There may be some benefit in asking Johnson and others (Soil Ecology Restoration Group), to re-sample their restoration planting, to assess success several years after planting.

#### **USFWS San Diego National Wildlife Refuge: Par 4 Management Units 1 and 2**

These MUs need to be characterized before management and monitoring plans can be made. These MUs are fairly large, and do not seem to be at immediate risk of extirpation. Therefore, a Quiescent management regime seems appropriate, until results of the Mission Trails weeding experiment are evaluated. Repeat-mapping monitoring conducted in 2003 and 2005 indicates high site fidelity, with little change in the location of patches within each of the Units. We recommend repeat mapping again in 2007 as a status check. One area at the eastern edge of Unit 1 was disked for a fire break in 2003 and 2004 (John Martin, U.S. Fish and Wildlife Service, oral commun., 2006), and San Diego ambrosia is present in those areas. If fire break maintenance is a necessary management tool for this parcel because of agency policy, it might be advantageous to investigate ways to use the management treatment in an experiment to test disking or mowing effects on ambrosia ramet cover or density. Such an experiment should be designed as a complement to the weeding management experiment at Mission Trails Parcel C6. If annual grass reduction is effective at increasing ambrosia cover or density there, mowing might be suggested as a means to apply weed reduction on a larger scale. In this way, two jurisdictions could work together on separate but related monitoring addressing management for invasive grass reduction.

## **USFWS San Diego National Wildlife Refuge: Sweetwater Bridge Sites at Horse Trail and South of Steele Canyon Bridge**

Both of these sites need to be characterized before management and monitoring plans can be made. Foot and horse trails skirt the edges of the small patches of San Diego ambrosia at these MUs (John Martin, U.S. Fish and Wildlife Service, oral commun.2006), suggesting that trampling and soil compaction might be major threats to the ambrosia at these sites. With so few ramets, likely representing only a few plants, these MUs might demand an Intensive Care management regime. MU characterization should be done in 2006 for these sites, so that action can be planned and taken soon, to prevent further losses. The short-term goal for these sites is to prevent extirpation, and active management is probably warranted. Status monitoring should be done along with the MU characterization. At sites with so few plants, simply counting ramets and mapping population boundaries might be the best census technique, rather than some sampling design.

### **Private: Site 49**

This MU is not on MSCP-designated lands, so management and monitoring are not required there. However, some periodic check of the site could be done, to inform evaluations of the species' status across the south county region. Such information aids in the evaluation and prioritization of those MUs that are on MSCP jurisdictional properties.

This page intentionally left blank.

