



CHAPTER 4: FUTURE CONDITIONS ASSESSMENT

Future conditions for the University Avenue Mobility Study addresses how the University Avenue Corridor will operate under the Year 2030 conditions.

The 2030 conditions analysis was conducted based on two (2) basic roadway network scenarios. The first scenario did not assume any changes to the existing roadway network for the University Avenue Corridor. The second scenario considered an alternative which deleted the Chollas Parkway connection to University Avenue, thereby eliminating the University Avenue/Chollas Parkway intersection.

No additional roadway/intersection improvements or improvements to the pedestrian, bicycle, or transit network were assumed under the 2030 conditions analysis. Thus the goal of the future conditions analysis is to identify if there are any locations along the corridor that would operate at a less than acceptable level of service in the future Year 2030 if no improvements to the corridor were made.

4.1 FORECASTING METHODOLOGY

Travel demand forecasts in the study area varied by mode. All travel demand forecasting; however, was based on one common principal – land use for the study area was based on the current, adopted Mid-Cities Community Plan for the Eastern Area. As noted earlier, the forecasts for the 2030 conditions were based on the following two (2) roadway network scenarios:

- Scenario 1: Based on the Existing Roadway Network; and
- Scenario 2: Based on the Deletion of the Chollas Parkway Connection to University Avenue.

Figures 4-1 and 4-2 provide an illustration of the roadway classifications and intersection geometrics for the 2030 conditions based on Scenario 1 (the existing roadway network) and Figures 4-3 and 4-4 an illustration of the roadway classifications and intersection geometrics for the 2030 conditions based on Scenario 2 (the deletion of the Chollas Parkway connection to University Avenue).

Traffic Forecasts

The San Diego Association of Governments (SANDAG) Series 11 traffic forecast which is available on SANDAG's website (<http://gis.sandag.org/tficsr11/f2030tf30/viewer.htm>) was utilized to estimate the 2030 traffic volumes while future transit demand and ridership were estimated based on discussions with SANDAG and Metropolitan Transit System (MTS).

To verify the validity of the traffic volumes provided on the SANDAG Series 11 2030 traffic forecasts, D&A reviewed the land use data that SANDAG utilized to generate the traffic forecasts and compared them with the land use assumptions included in the Mid-Cities Community Plan for the Eastern Area. The land use data was also provided to the City of San Diego staff to verify that it was consistent with the City's long range planning goals. The City of San Diego confirmed that the land use information for the project study area utilized by SANDAG to generate the Series 11 2030 traffic forecast was consistent with the Mid-City Community Plan and the City's long range planning goals.

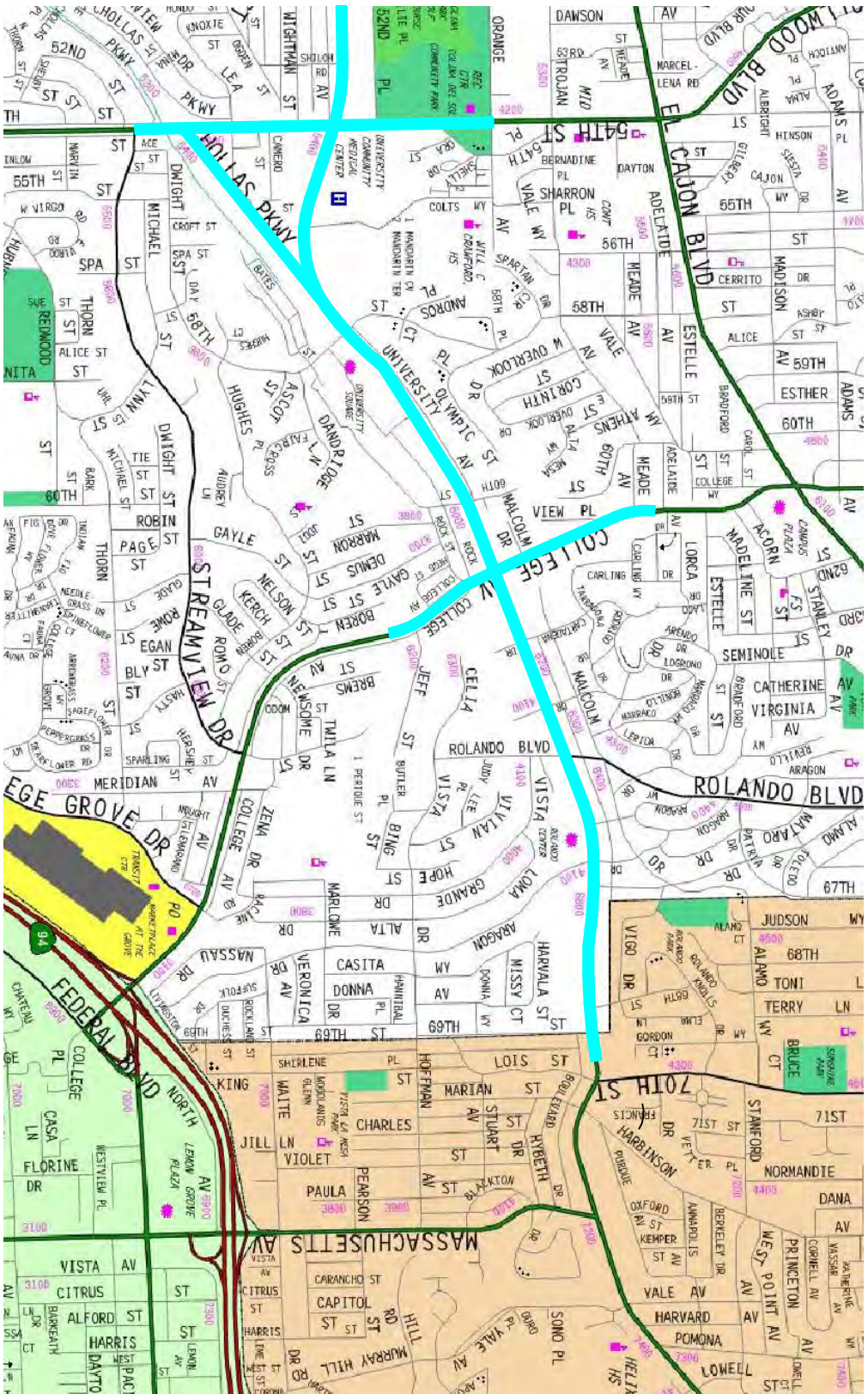

LEGEND
 MAJOR ARTERIAL (4-LANES), CAPACITY AT LOS E - 40,000

Darnell & ASSOCIATES, INC.
 100201FF-1.dwg 4-26-11 JMM

FIGURE 4-1
 2030 ROADWAY CLASSIFICATIONS
 (WITH EXISTING ROADWAY NETWORK)

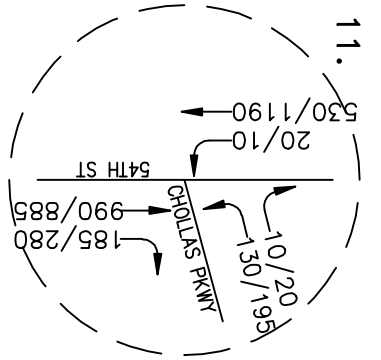
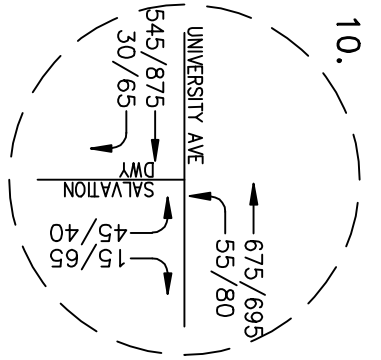
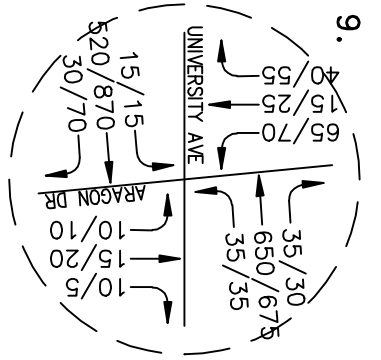
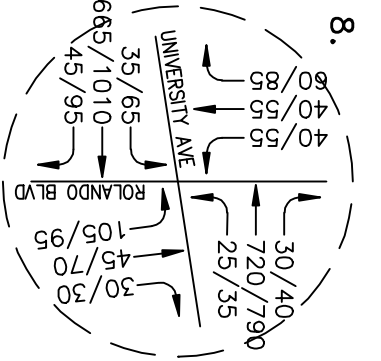
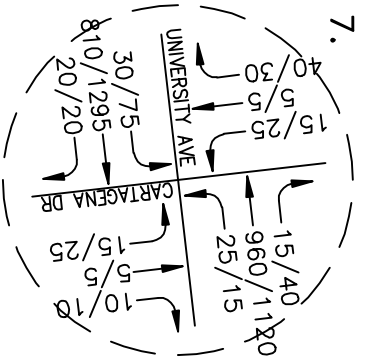
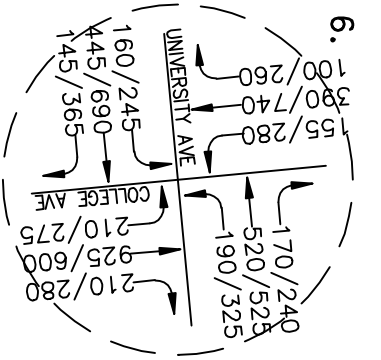
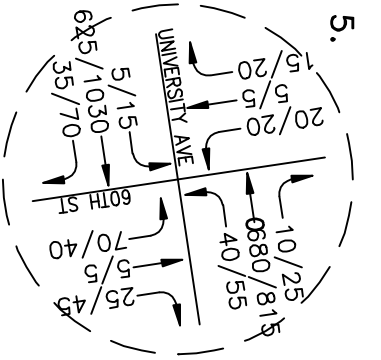
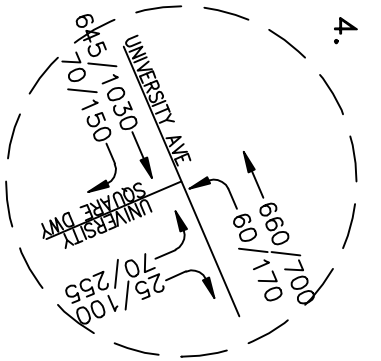
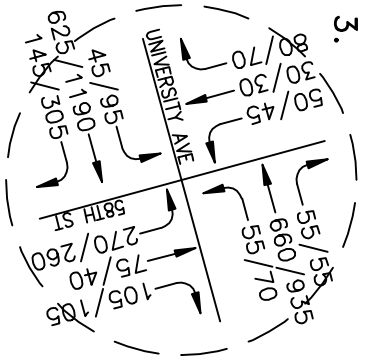
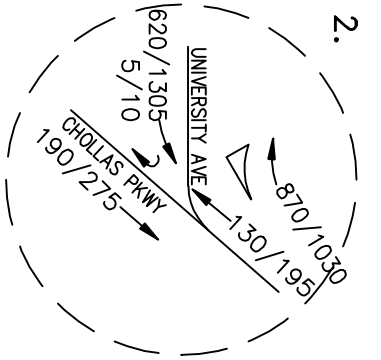
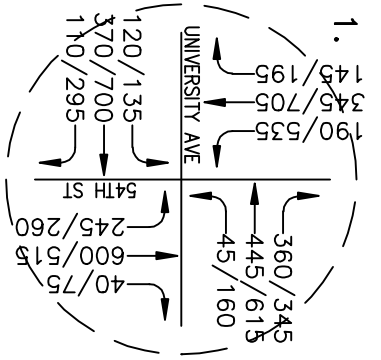
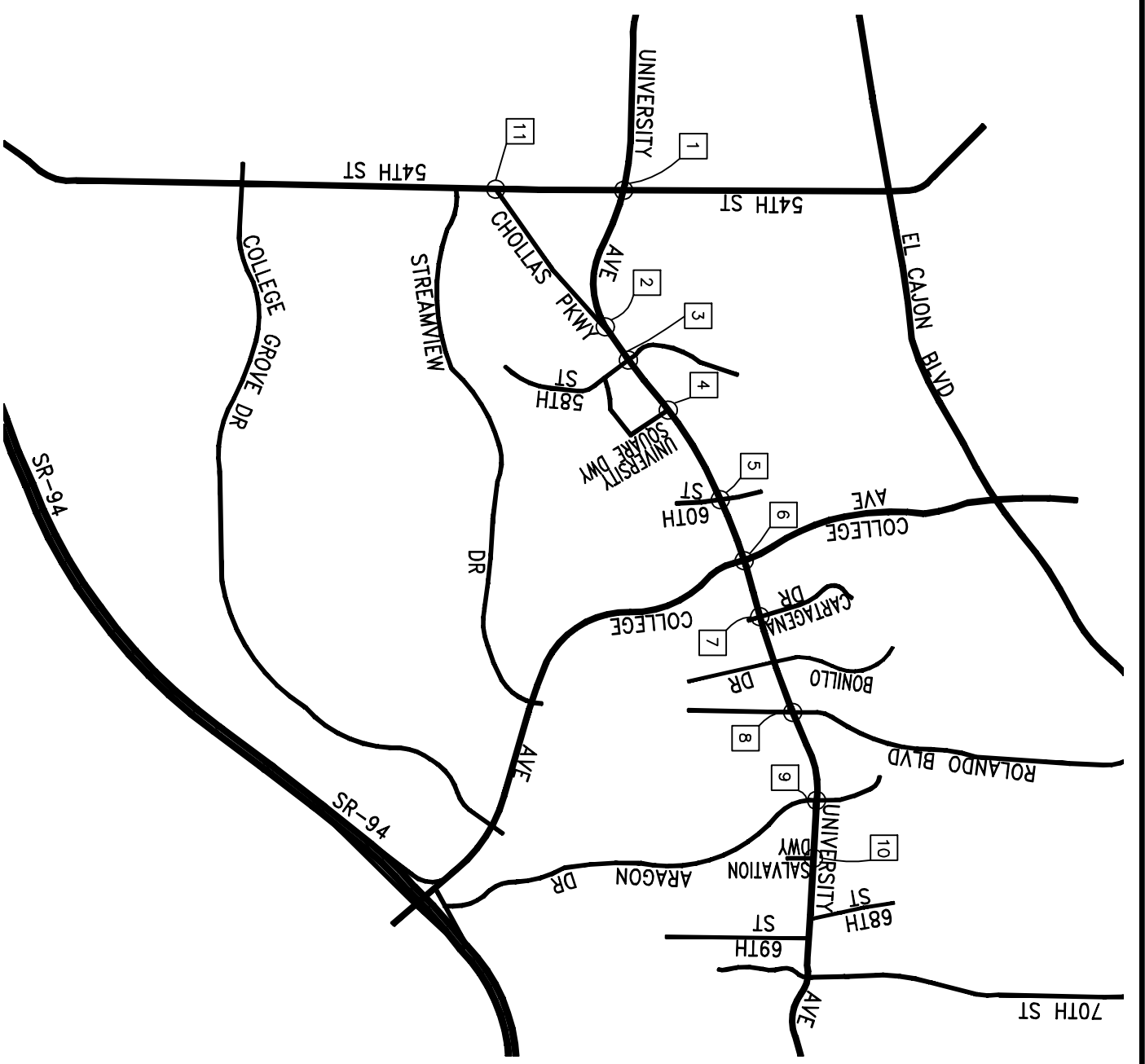

LEGEND
 ——— DIRECTION OF TRAVEL
 VV/MW — AM/PM PEAK HOUR TRAFFIC VOLUME

Darnell & ASSOCIATES, INC.
 100201EE.dwg 4-08-11 SN/JM
FIGURE 4-2
 SUMMARY OF YEAR 2030 PEAK
 HOUR TRAFFIC VOLUMES

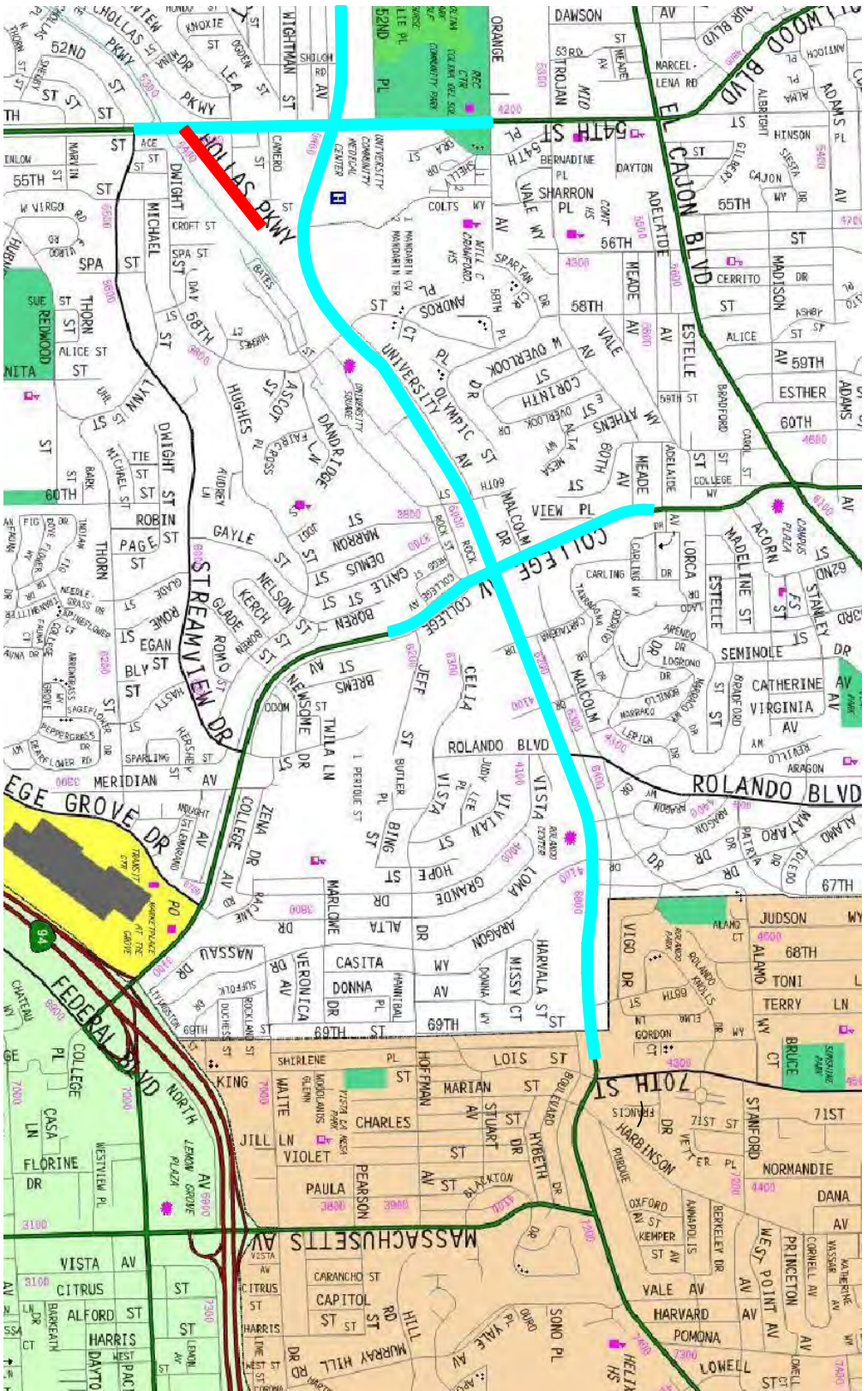

LEGEND
 - MAJOR ARTERIAL (4-LANES) CAPACITY AT LOS E - 40,000
 - COLLECTOR (2-LANES) CAPACITY AT LOS E - 8,000

Darnell & ASSOCIATES, INC.
 100201FF-1.dwg 4-27-11 JMM

FIGURE 4-3
 2030 ROADWAY CLASSIFICATION (WITH DELETION OF
 CHOLLAS PARKWAY CONNECTION TO UNIVERSITY AVENUE)

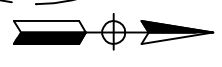
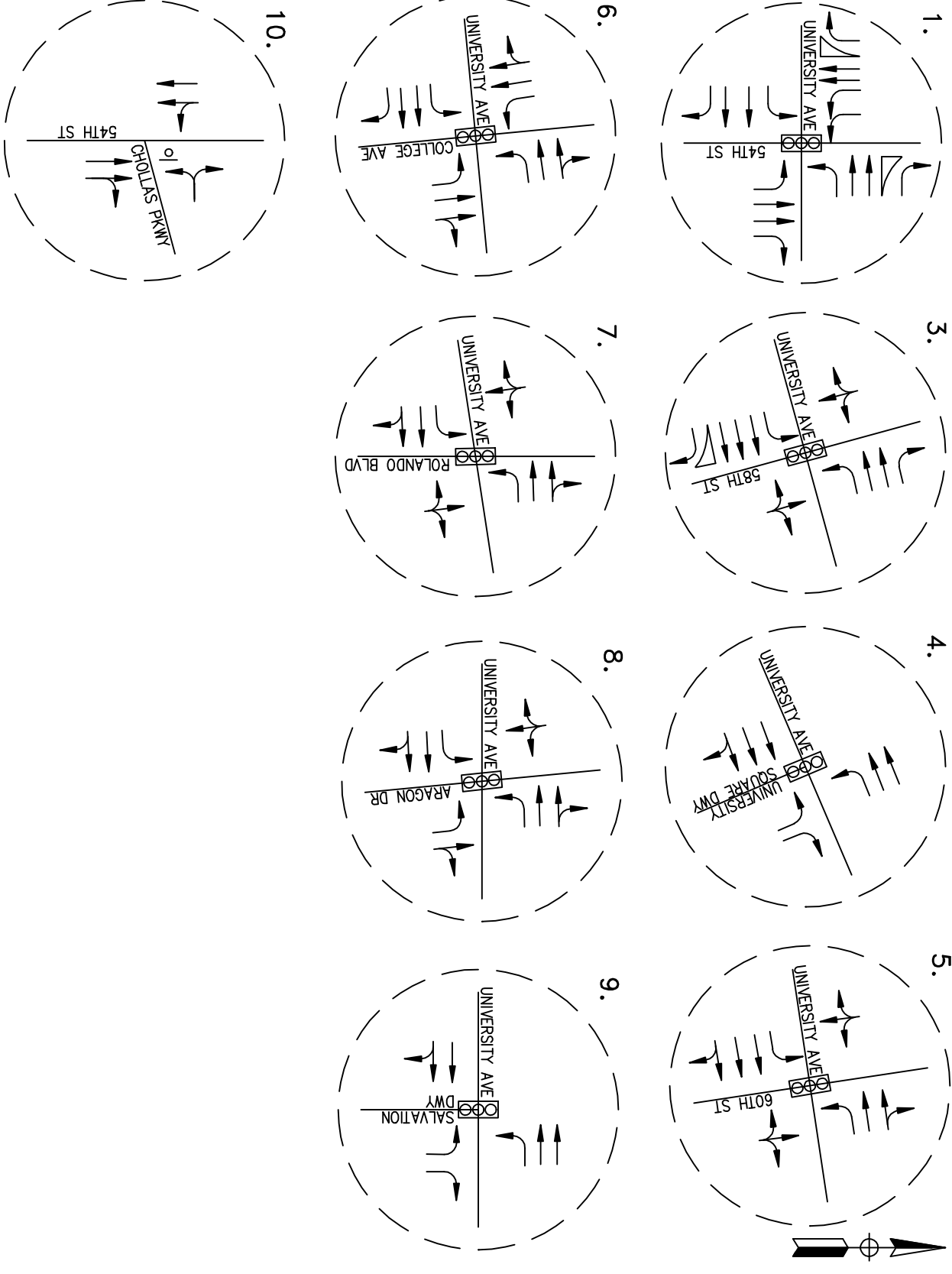
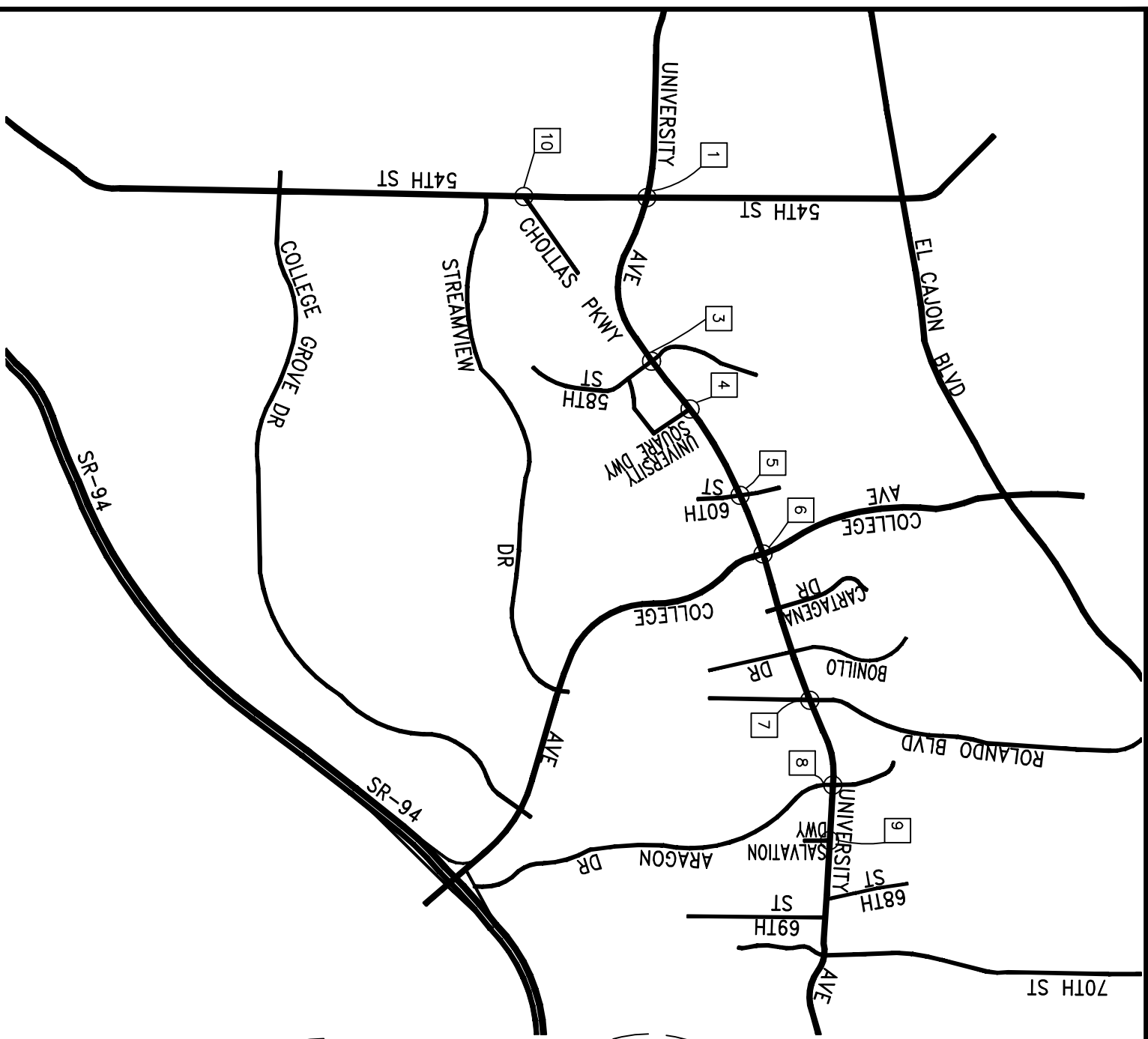

LEGEND
 ——— TRAVEL LANE
 ⊠ TRAFFIC SIGNAL
 ○ STOP SIGN

Darnell & ASSOCIATES, INC.
 100201FF.dwg 4-27-11 SN/JM

FIGURE 4-4
 YEAR 2030 INTERSECTION GEOMETRICS (WITH
 DELETION OF CHOLLAS PKY CONNECTION TO UNIVERSITY AVE)



To further validate the Series 11 traffic model, D&A compared the SANDAG Series 11 2010 traffic forecast volumes to the existing traffic counts that were collected in the field at the end of November beginning of December 2010. The comparison found that the SANDAG Series 11 2010 traffic forecasts were on average within 6 percent (6%) of the existing field counts. Therefore, based on a review of the land use compatibility and the traffic forecast projections it was determined that the SANDAG Series 11 traffic model would provide an accurate tool for projecting the future forecast volumes for the area.

Since the land use data provided in the SANDAG Series 11 regional traffic model were consistent with the Mid-Cities Community Plan for the Eastern Area and with the City's long range planning goals, no changes to the SANDAG Series 11 traffic model were made. Thus the 2030 daily traffic volumes for the University Avenue Corridor were obtained directly from the SANDAG Series 11 2030 regional traffic model that is provided on SANDAG's website (<http://gis.sandag.org/tficsr11/f2030tf30/viewer.htm>).

Peak hour intersection turning volumes for 2030 conditions were estimated by adding a growth factor to the existing peak hour turning volumes at the intersections. The growth factor was determined by comparing the change in volume that occurred along the roadway segments between existing and 2030 conditions. Since a growth factor was applied to the existing peak hour intersection turning volumes, the proportion of ADT occurring in the peak hour (K factor) and the proportion of peak-hour traffic occurring in the peak direction (D factor) under 2030 conditions would be the same as what exists today.

The 2030 daily and peak hour traffic volumes are illustrated in Figures 4-5 and Figures 4-6, respectively for Scenario 1 (the existing roadway network). The 2030 daily and peak hour traffic volumes for Scenario 2 (the deletion of the Chollas Parkway connection to University Avenue) are illustrated in Figures 4-7 and Figures 4-8, respectively.

Pedestrian/Bicycle Demand Forecasting

Future pedestrian and bicycle demand was estimated by reviewing the *City of San Diego's Pedestrian Master Plan*, December 2006 and the *City of San Diego's Bicycle Master Plan Update*, Final Draft April 2011. Additional criteria that was considered in estimating the future pedestrian and bicycle demand included:

- Forecasted Change in Traffic Volume;
- Projected Change in Transit Ridership;
- Potential Changes in Land Use Which Could Generate/Detract Pedestrians/Bicycles; and
- Planned Improvements Within Study Area Which Could Generate/Detract Pedestrians/Bicycles.

A review of the *City of San Diego's Pedestrian Master Plan*, December 2006 found that there is forecasted to be low pedestrian activity along the University Avenue Corridor. Although the *City of San Diego's Pedestrian Master Plan* ranked the Mid-Cities Community-Eastern Area as number 18 out of 57 communities in the ranking of pedestrian prioritization, no specific pedestrian improvements were identified. Therefore, by the Year 2030, it was assumed that the pedestrian network would be the same as what exists on the ground today. Similarly, a review of the adopted Mid-Cities Community Plan for the Eastern area found that the land uses along the University Avenue Corridor will remain essentially the same by the Year 2030 as what they are today. Thus the primary influences on the change in pedestrian activity would be the change in traffic volume and transit ridership.

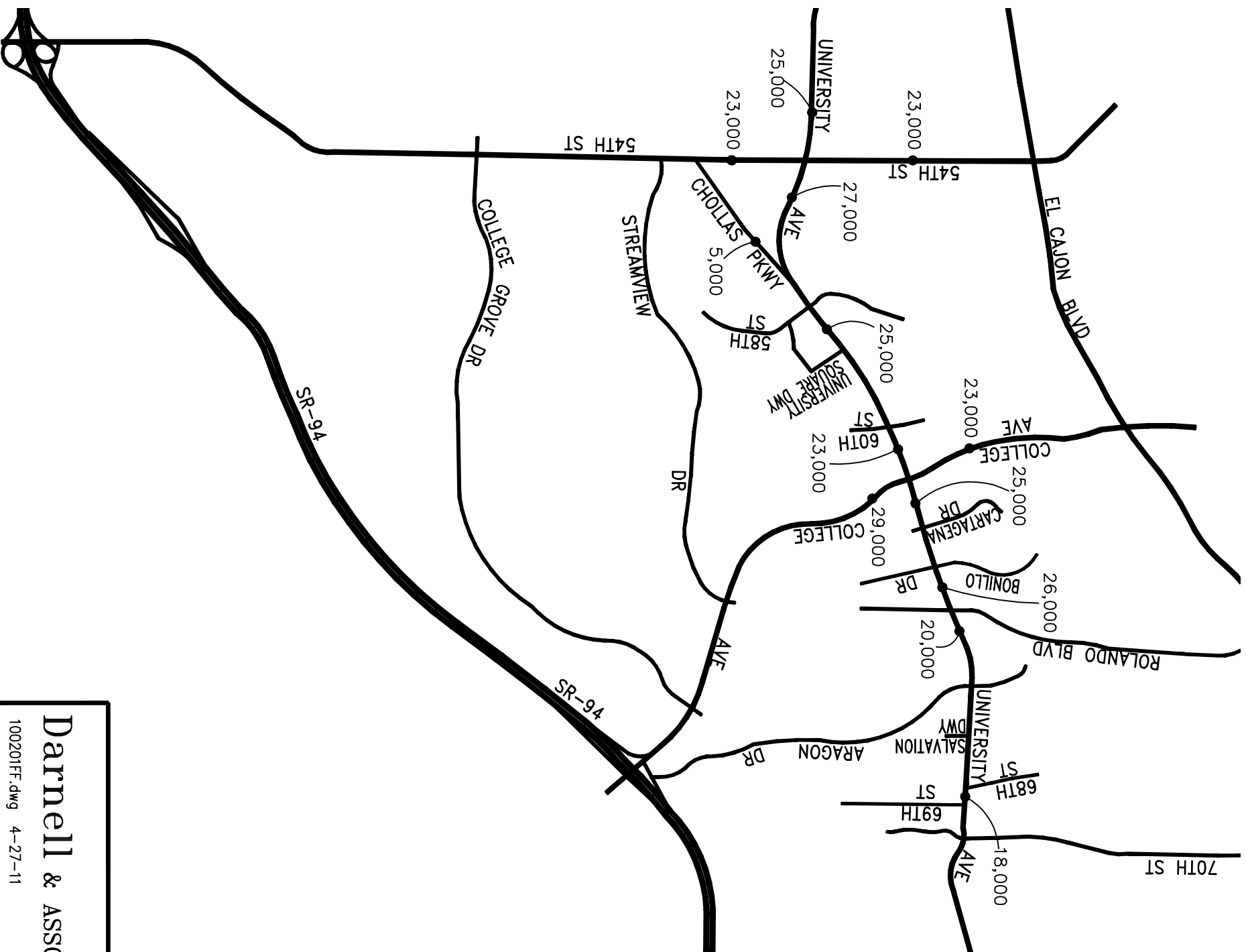
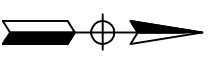

LEGEND

● Z,ZZZ - SERIES 11-SANDAG 2030 DAILY TRAFFIC VOLUME

Darnell & ASSOCIATES, INC.
100201FF.dwg 4-27-11 SN/JM/vs/JM

FIGURE 4-5
SUMMARY OF YEAR 2030
DAILY TRAFFIC VOLUMES (WITH EXISTING ROADWAY NETWORK)

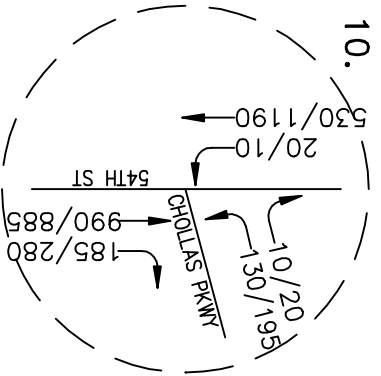
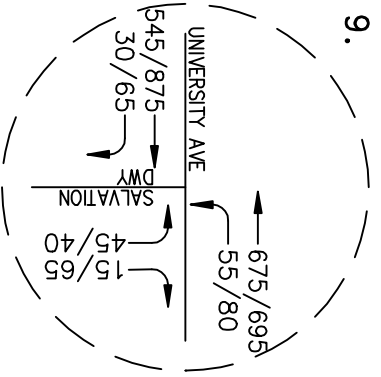
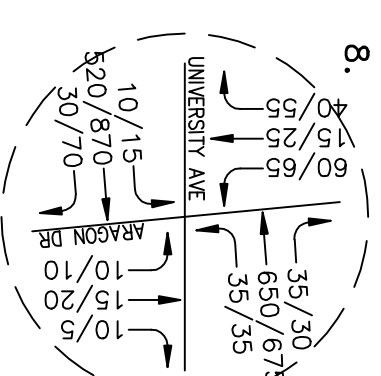
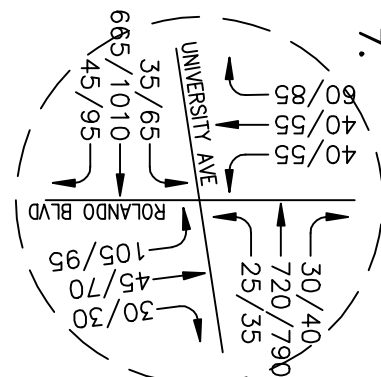
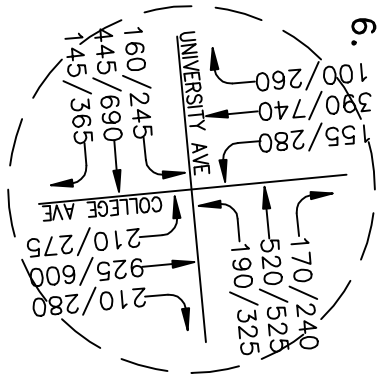
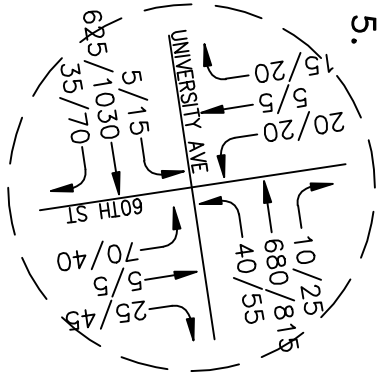
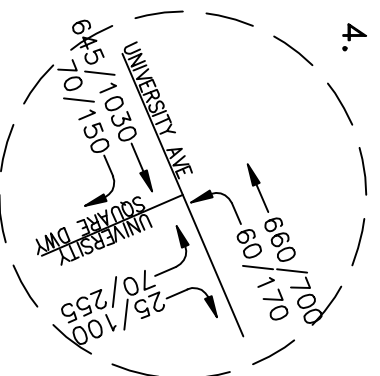
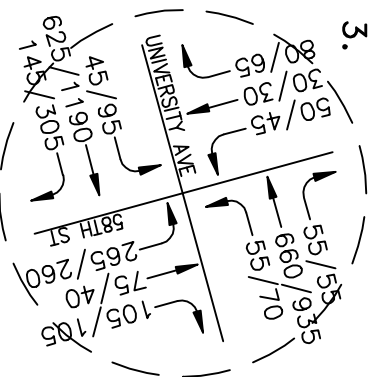
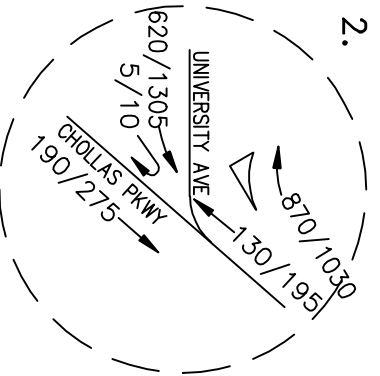
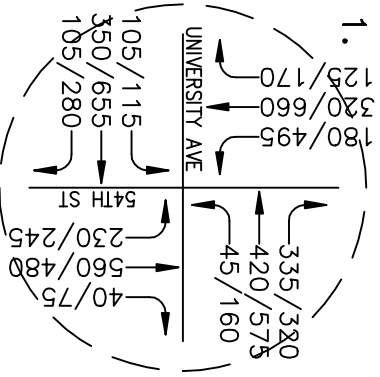
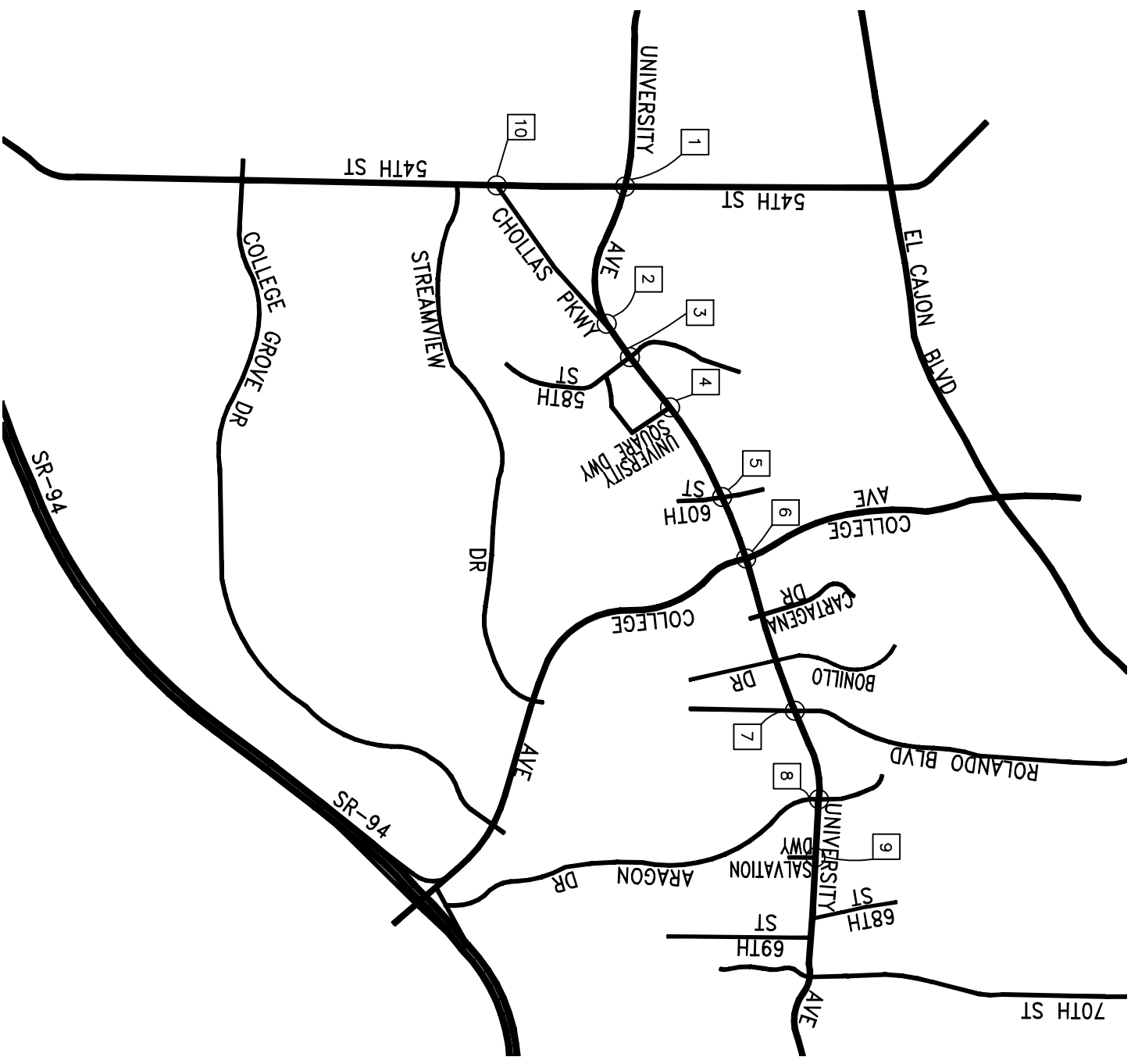

LEGEND
 - DIRECTION OF TRAVEL
 - AM/PM PEAK HOUR TRAFFIC VOLUME

Darnell & ASSOCIATES, INC.
 100201FF.dwg 4-27-11 SN/JM

FIGURE 4-6
 SUMMARY OF YEAR 2030 PEAK
 HOUR TRAFFIC VOLUMES (WITH EXISTING ROADWAY NETWORK)

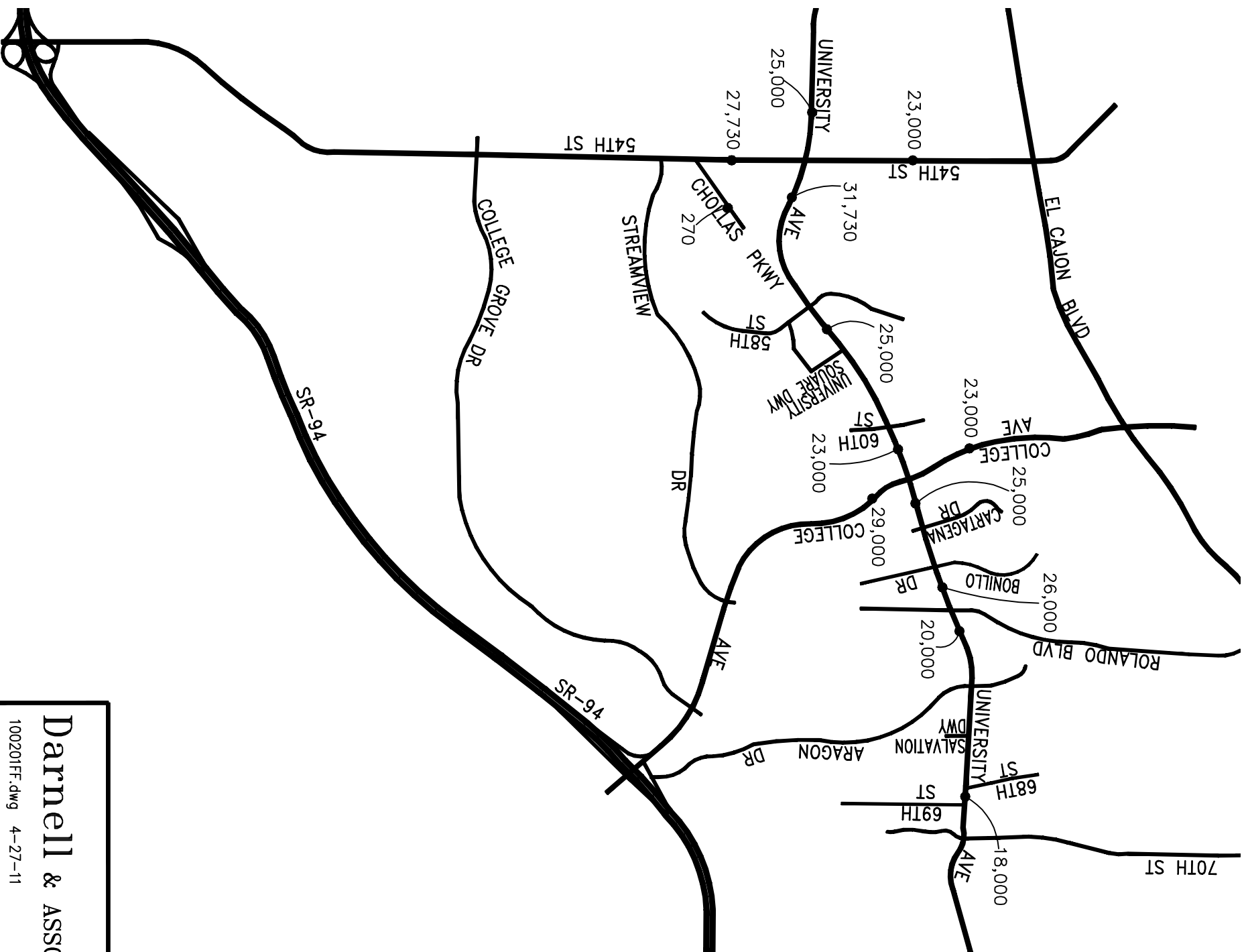
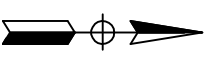

LEGEND

● Z,ZZZ – SERIES 11–SANDAG 2030 DAILY TRAFFIC VOLUME

Darnell & ASSOCIATES, INC.

100201FF.dwg 4-27-11 SN/JM/vs/JM

FIGURE 4-7

SUMMARY OF YEAR 2030 DAILY TRAFFIC VOLUMES
(WITH DELETION OF CHOLLAS PKWY CONNECTION TO UNIVERSITY AVENUE)

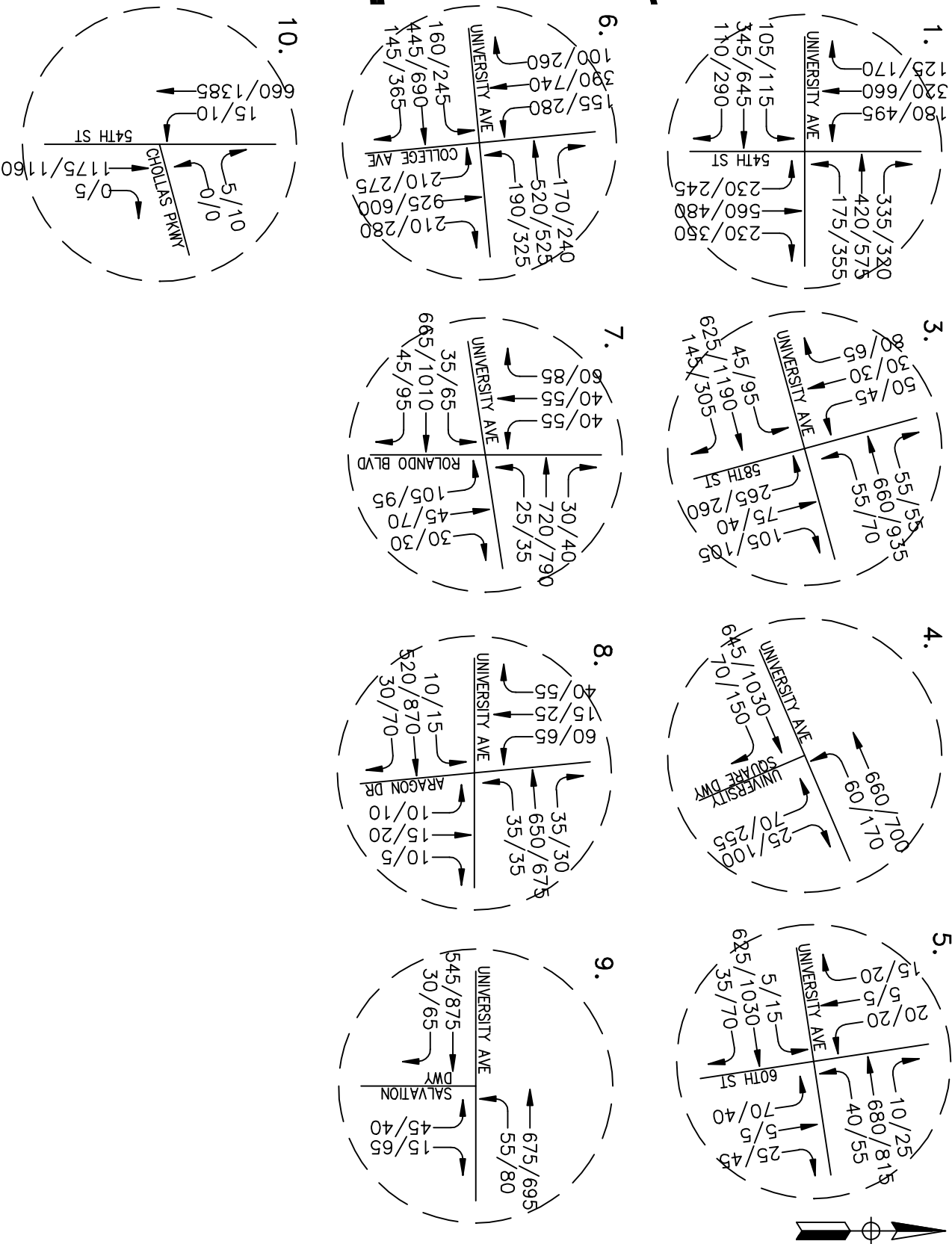

LEGEND
 - DIRECTION OF TRAVEL
 - AM/PM PEAK HOUR TRAFFIC VOLUME

Darnell & ASSOCIATES, INC.
 100201FF.dwg 4-27-11 SN/JM

FIGURE 4-8
 SUMMARY OF YEAR 2030 PEAK HOUR TRAFFIC VOLUMES
 (WITH DELETION OF CHOLLAS PKWY CONNECTION TO UNIVERSITY AVE)



UNIVERSITY AVENUE MOBILITY STUDY

Based on a comparison of the SANDAG 2030 volumes to the existing 2011 traffic volumes, there was an average growth in traffic along the University Avenue Corridor of approximately 23%, and per discussions with MTS, transit ridership along the University Avenue Corridor is projected to grow approximately 1% per year for a total growth of 19% by the year 2030. The 23% increase in traffic volume would generally be a pedestrian detractor while the 19% increase in transit ridership would generally be a pedestrian generator. Thus to, assess the worse-case scenario, the future pedestrian demand was estimated by applying a 25% growth to the existing pedestrian demand. The 25% growth factor not only accounts for the increase in transit ridership but potential increases in school related pedestrian traffic. Since the *City of San Diego's Pedestrian Master Plan*, December 2006 found that there is forecasted to be low pedestrian activity along the University Avenue Corridor, the 25% growth in pedestrian activity should more than accurately account for the future pedestrian demands in the area.

A review of Figure 5-8 from the *City of San Diego's Bicycle Master Plan Update*, Final Draft April 2011 found that the projected bicycle demand along University Avenue between 54th Street and Aragon Drive is projected to be high and the bicycle demand along University Avenue between Aragon Drive and 69th Street is projected to be medium. In addition, the *City of San Diego's Bicycle Master Plan Update* identified the segment of University Avenue between Fairmount Avenue to the La Mesa City's Limit as project 27 out of 40 recommended bicycle improvement projects in the City of San Diego. Project 27 called for adding Class II Bike Lanes along University Avenue between Fairmount Avenue and the La Mesa City Limits. Since it is not known when the Class II Bike Lanes will be provided along the University Avenue Corridor, for analysis purposes the 2030 conditions assumed that the bicycle network would be the same under 2030 conditions as it is today. However, consideration was given to providing Class II Bike Lanes along the corridor as part of the project.

Although the *City of San Diego's Bicycle Master Plan Update* identified the University Avenue Corridor bicycle demand as being medium to high, it did not identify any specific future bicycle volumes. Therefore, in order to estimate the future bicycle demand a growth factor of 100% was applied to the existing bicycle demand. The 100% growth factor accounts for the increase in transit ridership, the potential increases in school related bicycle traffic, and acknowledges that the City's Bicycle Master Plan projects the future bicycle demand along the corridor to be high.

Figure 4-9 illustrates the future year 2030 morning and afternoon peak periods pedestrian and bicycle crossings. It should be noted that the volume of pedestrian and bicycle crossings are not anticipated to be impacted by the deletion of the Chollas Parkway connection to University Avenue. Thus the pedestrian and bicycle volumes illustrated in Figure 4-9 would be applicable for either the Scenario 1 (existing roadway network) or Scenario 2 (the deletion of the Chollas Parkway connection to University Avenue) roadway network alternatives.

Transit Ridership

Based on the currently adopted 2030 Regional Transportation Plan (RTP), the bus routes along the University Avenue Corridor are anticipated to remain the same with the exception that the efficiency of Route 10 is anticipated to improve such that the headways will be decreased from 15 minutes down to 10 minutes. Per discussions with MTS, there is a possibility that in the future Route 7 may be split such that it would end at 69th Street; however, since the potential split of Route 7 is very preliminary it was not included in the 2030 conditions.

Based on discussions with MTS, future transit ridership was estimated based on an annual growth rate of 1% per year for a total growth of 19% by the Year 2030.

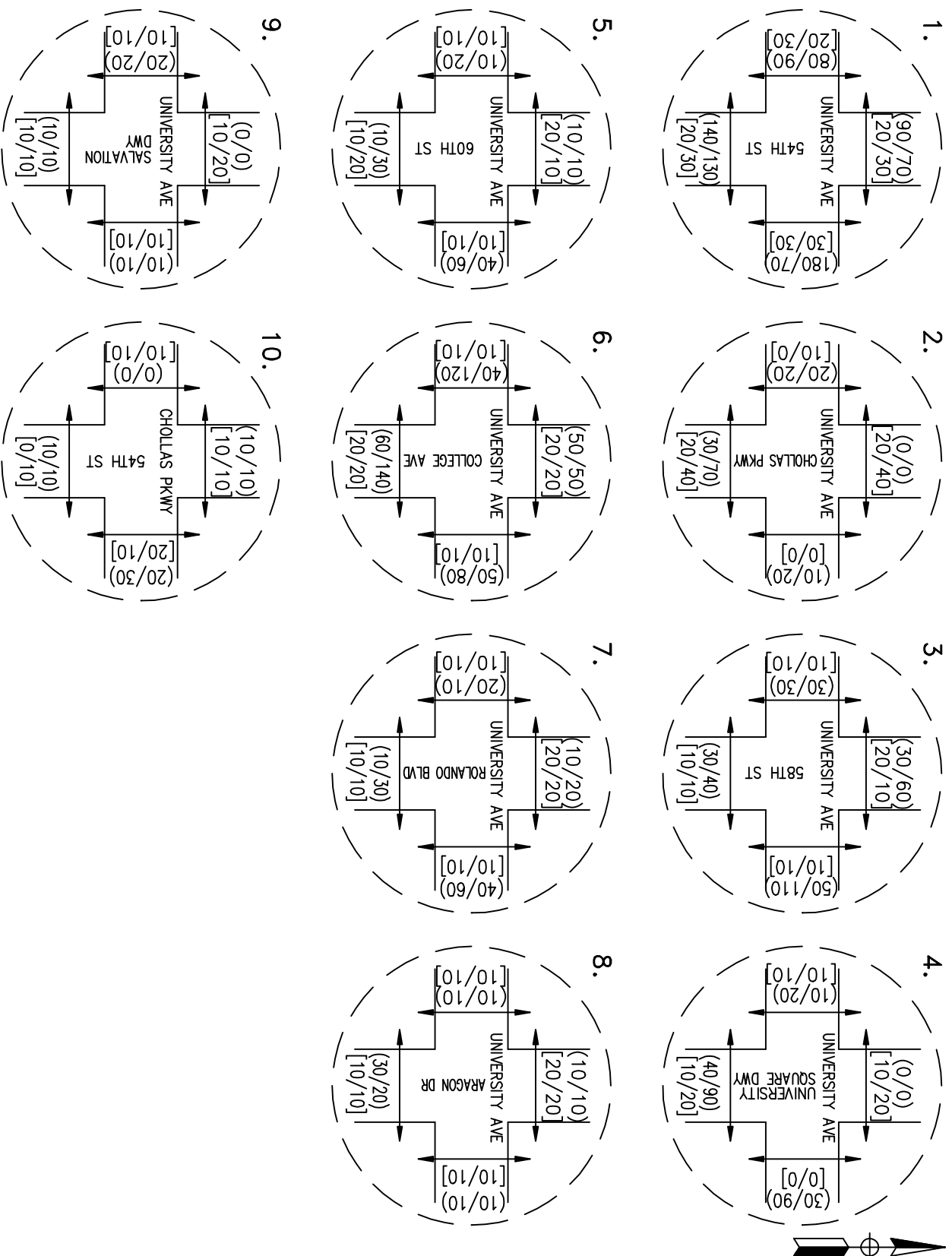

LEGEND

- CROSSING APPROACH/DIRECTION OF TRAVEL
- (VV/WW) — AM/PM PEDESTRIAN CROSSING
- [XX/YY] — AM/PM BICYCLE CROSSING
- NOTE: AM PEDESTRIAN & BICYCLE CROSSING ARE FROM 6:30-9:00 AM
- PM PEDESTRIAN & BICYCLE CROSSING ARE FROM 3:30-6:00 PM

Darnell & ASSOCIATES, INC.

100201FF.dwg 4-27-11

SN/JM

FIGURE 4-9

SUMMARY OF YEAR 2030 AM & PM PEDESTRIAN & BICYCLE CROSSINGS



4.2 TRAFFIC OPERATIONAL ANALYSIS

Year 2030 Roadway Segment Level of Service Analysis

Year 2030 conditions are based on the roadway classifications configurations, previously depicted in Figure 4-1 for Scenario 1 (the existing roadway network) and Figure 4-3 for Scenario 2 (the deletion of the Chollas Parkway connection to University Avenue). The roadway segments levels of service along the study corridor were determined by comparing, the 2030 daily traffic volumes (as depicted in Figures 4-5 and 4-7) to the roadway segments City of San Diego classification thresholds. Volume to capacity ratios were calculated for each roadway segment. The results of the roadway segment level of service analysis are summarized in Table 4-1 and illustrated in Figure 4-10 for Scenario 1 (the existing roadway network) and Figure 4-11 for Scenario 2 (the deletion of the Chollas Parkway connection to University Avenue).

Segment	Class	# of Lanes	LOS E Capacity	Scenario 1 (Existing Roadway Network)			Scenario 2 (Deletion of Chollas Pkwy. Connection to University Ave.)		
				ADT	V/C	LOS	ADT	V/C	LOS
University Avenue									
West of 54 th St.	4M	4	40,000	25,000	0.63	C	25,000	0.63	C
54 th St. to 58 th St.	4M	4	40,000	27,000	0.68	C	31,730	0.79	D
58 th St. to 60 th St.	4M	5	40,000	25,000	0.63	C	25,000	0.63	C
60 th St. to College Ave.	4M	5	40,000	23,000	0.58	C	23,000	0.58	C
College Ave. to Cartagena Dr.	4M	4	40,000	25,000	0.63	C	25,000	0.63	C
Cartagena Dr. to Rolando Blvd.	4M	4	40,000	26,000	0.65	C	26,000	0.65	C
Rolando Blvd. to Aragon Dr.	4M	4	40,000	20,000	0.50	B	20,000	0.50	B
54th Street									
North of University Ave.	4M	4	40,000	23,000	0.58	C	23,000	0.58	C
South of University Ave.	4M	4	40,000	23,000	0.58	C	27,730	0.69	C
College Avenue									
North of University Ave.	4M	4	40,000	23,000	0.58	C	23,000	0.58	C
South of University Ave.	4M	4	40,000	29,000	0.73	C	29,000	0.73	C
Chollas Parkway (a)									
East of 54 th St.	4M	4	40,000	5,000	0.13	A	-	-	-
	2C	2	8,000	-	-	-	270	0.03	A

(a) Segment is classified as a 4-Lane Major Arterial under Scenario 1 and as a 2-Lane Collector under Scenario 2
 Class = roadway classification; ADT = average daily traffic/trips; V/C = volume to LOS E capacity; LOS = level of service
 4M = 4-Lane Major Arterial; 2C = 2-Lane Collector

As summarized in Table 4-1 and Figure 4-10, under Scenario 1 (the existing roadway network) based on average daily capacity, the segments of University Avenue from west of 54th Street to Rolando Boulevard are projected to operate a LOS C in the Year 2030 and the segment of University Avenue between Rolando Boulevard and Aragon Drive is projected to operate at LOS B. With the deletion of the Chollas Parkway connection to University Avenue the segment of University Avenue between 54th Street and 58th Street will degrade from LOS C to LOS D (see Figure 4-11). However, LOS D is still an acceptable level of service.

The future classification for the segment of University Avenue between Chollas Parkway and College Avenue per the Mid-Cities Community Plan is a 5- Lane Major Arterial. As noted in Table 4-1, this segment of University Avenue currently has 5-Lanes; however, it was analyzed with the capacity of a 4-Lane Major Arterial.

Future Conditions Assessment

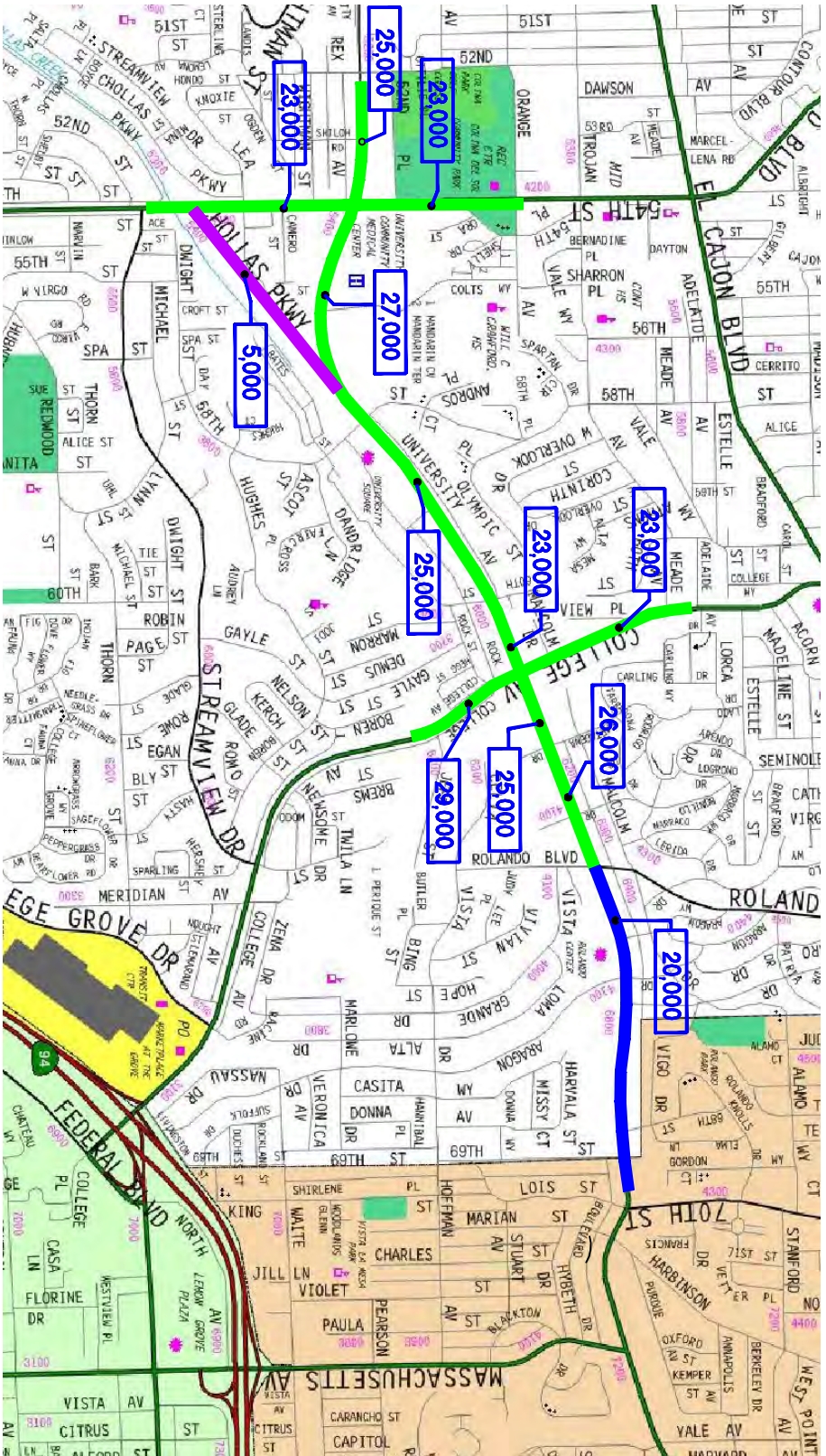

LEGEND

- █ - LOS A ZZZZ - AVERAGE DAILY TRAFFIC
- █ - LOS B CAPACITY AT LOS E - MAJOR ARTERIAL (4-LANES)-40,000
- █ - LOS C

Darnell & ASSOCIATES, INC.

100201F-1.dwg 4-26-11

JMM

FIGURE 4-10
SUMMARY OF YEAR 2030 ROADWAY SEGMENTS LEVELS OF SERVICE
(WITH EXISTING ROADWAY NETWORK)

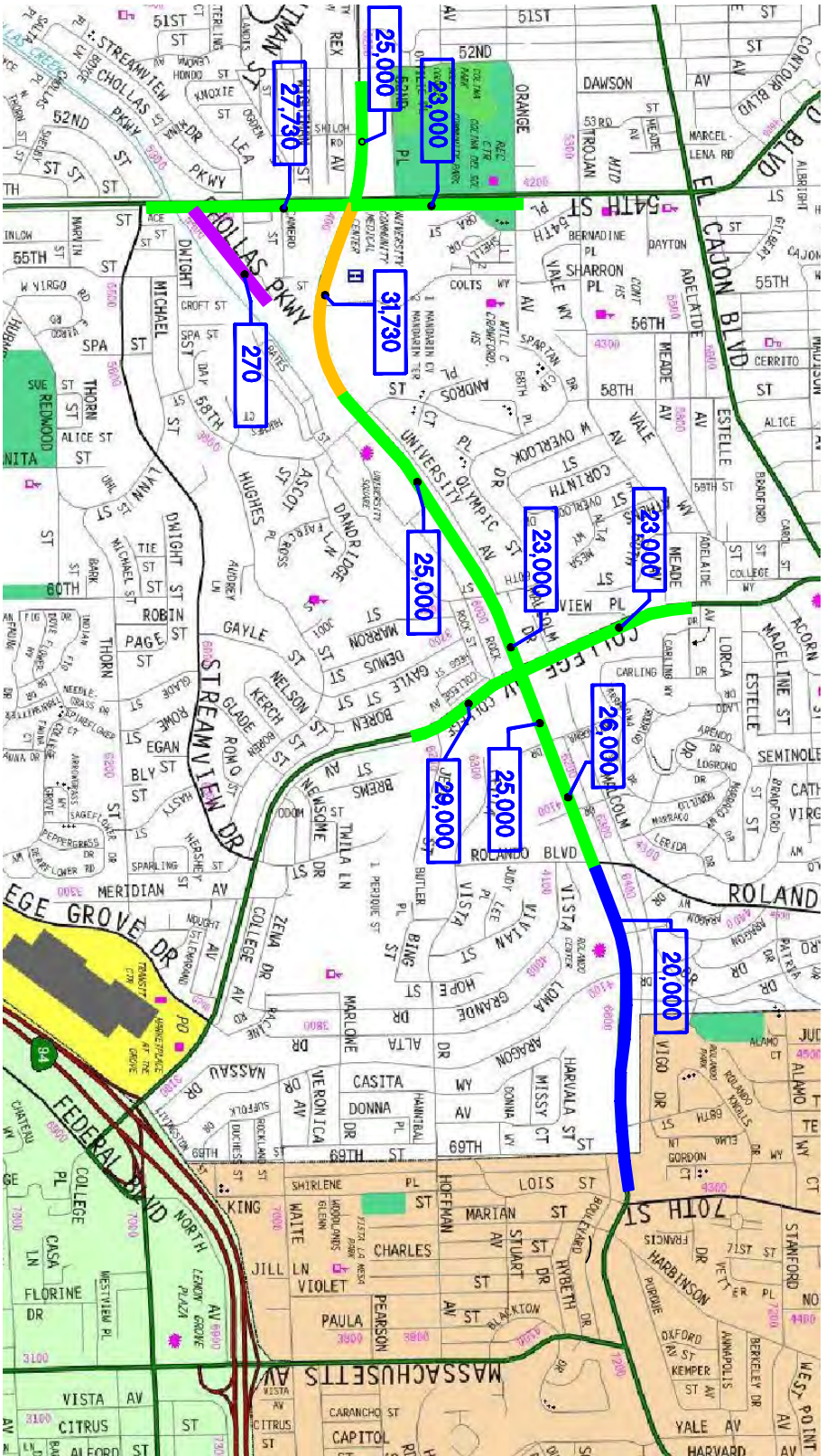

- LEGEND**
- █ - LOS A
 - █ - LOS B
 - █ - LOS C
 - █ - LOS D
- ZZZZ - AVERAGE DAILY TRAFFIC
- CAPACITY AT LOS E - MAJOR ARTERIAL (4-LANES)-40,000
- CAPACITY AT LOS E - COLLECTOR (2-LANES)- 8,000

Darnell & ASSOCIATES, INC.

100201F-1.dwg 4-27-11 JMM

FIGURE 4-11

SUMMARY OF YEAR 2030 ROADWAY SEGMENTS LEVELS OF SERVICE (WITH DELETION OF HOLLAS PARKWAY CONNECTION TO UNIVERSITY AVENUE)



Year 2030 Intersection Level of Service Analysis

As discussed in Chapter 2, the Synchro, version 6.0, software (which is based on the methodology outlined in the 2000 Highway Capacity Manual) was utilized to analyze the key intersections in the vicinity of the project.

The intersections levels of service for Year 2030 conditions were analyzed based on the intersection geometry previously illustrated in Figures 4-2 and 4-4 and the future traffic volumes depicted in Figures 4-6 and 4-8. (See Section 4.2 for a discussion on how the intersection peak hour traffic volumes for the Year 2030 were estimated.) The results of the level of service analysis are presented in Table 4-2 and graphically illustrated in Figure 4-12 for Scenario 1 (the existing roadway network) and Figure 4-13 for Scenario 2 (the deletion of the Chollas Parkway connection to University Avenue). The Synchro analysis worksheets are provided in Appendix E.

As shown in Table 4-2 and Figure 4-5, assuming no changes to the existing roadway network were made by the Year 2030 (Scenario 1), with the exception of the University Avenue/College Avenue intersection all signalized intersections are projected to operate at LOS D or better during both the AM and PM peak hours in the Year 2030. The University Avenue/College Avenue intersection is forecasted to operate at LOS D during the AM peak hour and LOS F during the PM peak hour by the Year 2030. In addition, the unsignalized intersections of University Avenue/Chollas Parkway and Chollas Parkway/54th Street which have critical movements that operate at LOS E or F under existing conditions will continue to have critical movements which operate at LOS F during the morning and/or afternoon peak hour in the Year 2030.

If the Chollas Parkway connection to University Avenue is deleted (Scenario 2); however, the University Avenue/54th Street intersection will operate at LOS D during the AM peak hour and LOS F during the PM peak hour by the Year 2030. Further, the level of service at the Chollas Parkway/54th Street will improve to an acceptable LOS B during both the AM and PM peak hours. All other intersections will continue to operate the same as they would under Scenario 1.

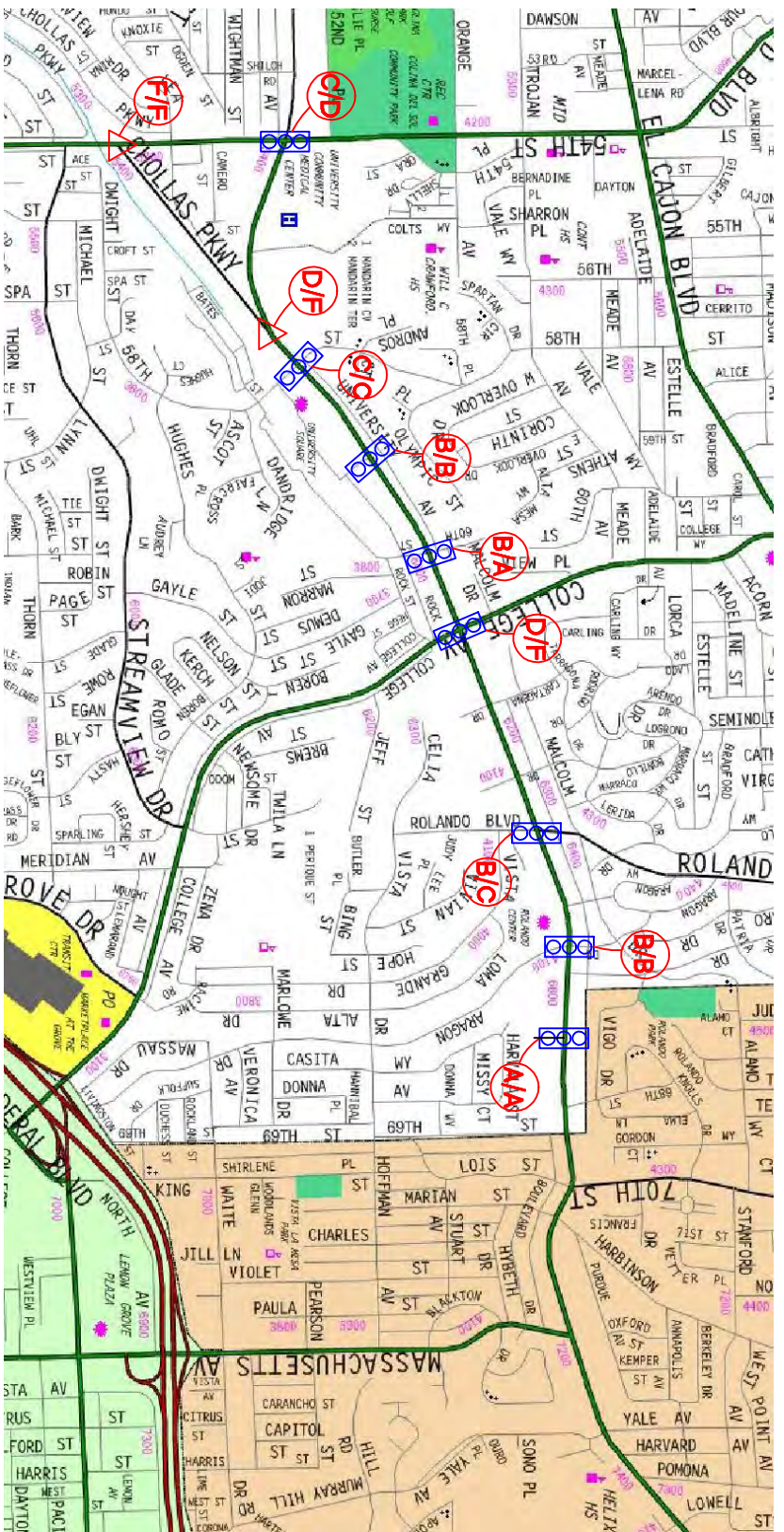

- LEGEND**
- X - TRAFFIC SIGNAL
 - △ - STOP CONTROLLED
 - X - AM/PM PEAK HOUR LOS FOR CRITICAL MOVEMENT

Darnell & Associates, Inc.
 100201FF-1.dwg 4-26-11 JMM

FIGURE 4-12
 SUMMARY OF YEAR 2030 INTERSECTIONS LEVELS OF SERVICE
 (WITH EXISTING ROADWAY NETWORK)

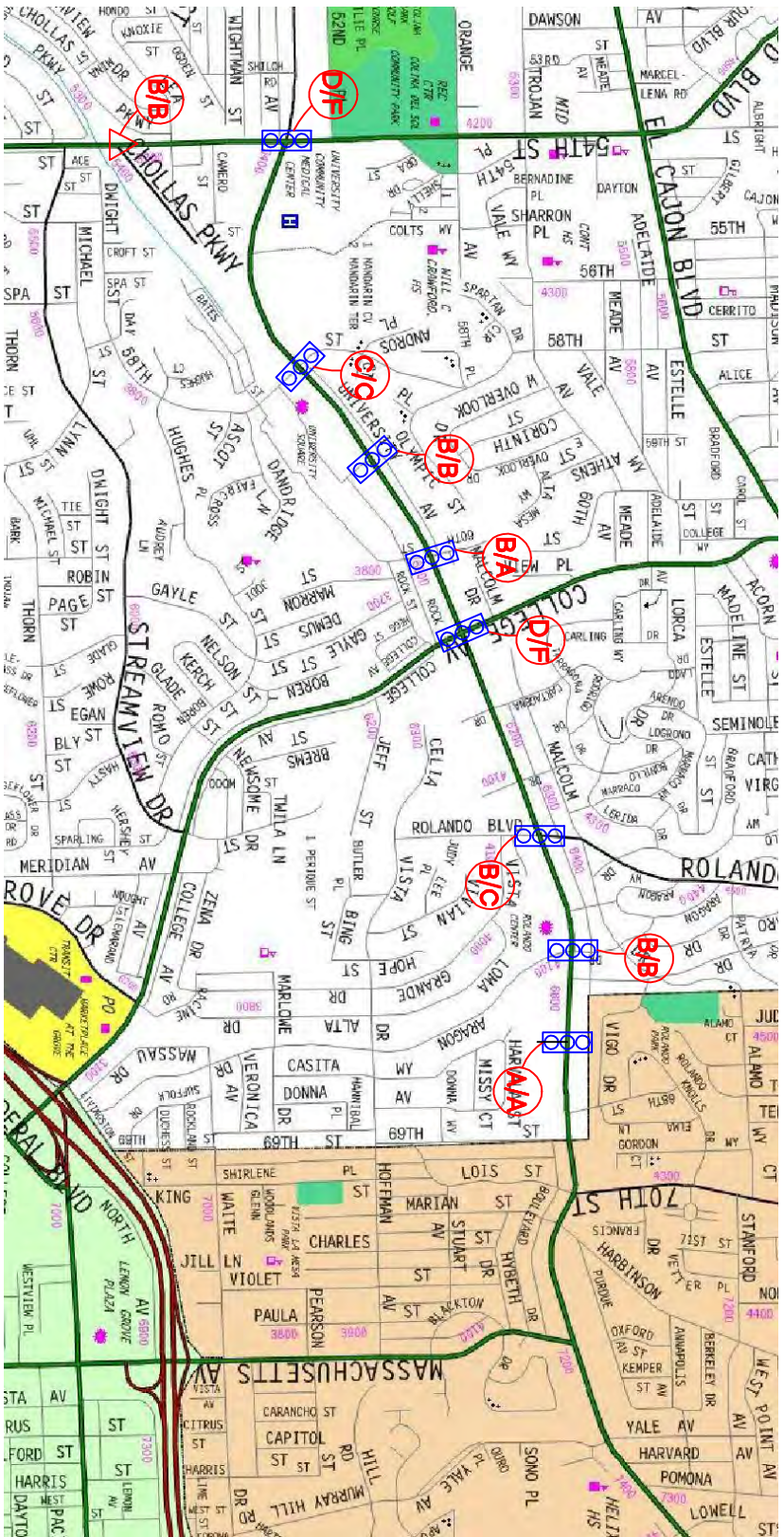

LEGEND

- - TRAFFIC SIGNAL
- ▲ - STOP CONTROLLED
- A/B - AM/PM PEAK HOUR LOS FOR CRITICAL MOVEMENT

Darnell & ASSOCIATES, INC.

100201FF-1.dwg 4-27-11

JMM

FIGURE 4-13

SUMMARY OF YEAR 2030 INTERSECTIONS LEVELS OF SERVICE (WITH DELETION OF CHOLLAS PARKWAY CONNECTION TO UNIVERSITY AVENUE)



UNIVERSITY AVENUE MOBILITY STUDY

Table 4-2 – Year 2030 Intersection Level of Service Summary						
Intersection	Traffic Control	Critical Movement	AM Peak Hour		PM Peak Hour	
			Delay (sec/veh)	LOS	Delay (sec/veh)	LOS
Scenario 1 – With Existing Roadway Network						
University Ave. (E-W) @ 54 th St. (N-S)	Signalized	Intersection	30.1	C	42.5	D
University Ave. (E-W) @ Chollas Pkwy. (N-S)	OWSC	WBL	33.3	D	221.3	F
University Ave. (E-W) @ 58 th St. (N-S)	Signalized	Intersection	24.3	C	28.7	C
University Ave. (E-W) @ University Square Dwy. (N-S)	Signalized	Intersection	10.8	B	16.5	B
University Ave. (E-W) @ 60 th St. (N-S)	Signalized	Intersection	15.0	B	9.0	A
University Ave. (E-W) @ College Ave. (N-S)	Signalized	Intersection	53.9	D	88.3	F
University Ave. (E-W) @ Rolando Blvd. (N-S)	Signalized	Intersection	17.6	B	21.3	C
University Ave. (E-W) @ Aragon Dr. (N-S)	Signalized	Intersection	11.0	B	12.7	B
University Ave. (E-W) @ Salvation Dwy. (N-S)	Signalized	Intersection	7.4	A	9.7	A
Chollas Pkwy. (E-W) @ 54 th St. (N-S)	OWSC	WB	194.9	F	716.7	F
Scenario 2 – With Deletion of Chollas Parkway Connection to University Avenue						
University Ave. (E-W) @ 54 th St. (N-S)	Signalized	Intersection	39.2	D	94.6	F
University Ave. (E-W) @ Chollas Pkwy. (N-S)	Does Not Exist					
University Ave. (E-W) @ 58 th St. (N-S)	Signalized	Intersection	24.3	C	28.7	C
University Ave. (E-W) @ University Square Dwy. (N-S)	Signalized	Intersection	10.8	B	16.4	B
University Ave. (E-W) @ 60 th St. (N-S)	Signalized	Intersection	15.0	B	9.1	A
University Ave. (E-W) @ College Ave. (N-S)	Signalized	Intersection	53.9	D	88.3	F
University Ave. (E-W) @ Rolando Blvd. (N-S)	Signalized	Intersection	17.6	B	21.3	C
University Ave. (E-W) @ Aragon Dr. (N-S)	Signalized	Intersection	11.0	B	12.7	B
University Ave. (E-W) @ Salvation Dwy. (N-S)	Signalized	Intersection	7.4	A	9.7	A
Chollas Pkwy. (E-W) @ 54 th St. (N-S)	OWSC	WB	14.1	B	14.4	B
sec/veh = seconds of delay per vehicle; LOS = level of service; E-W = east-west street; N-S = north-south street WB = westbound approach; WBL = westbound left; OWSC = one-way stop-controlled						

Future Conditions Assessment



Year 2030 Travel Speed Assessment

Under existing conditions, the average travel speeds during the peak periods was evaluated based on a floating car assessment. Under future conditions; however, a traffic model has to be utilized to predict the Average travel speeds of the traffic based on procedures outlined in the HCM. As discussed in Chapter 2, per the HCM, the average travel speed for a segment is based on the running times for the arterial street and the control delay of the through movements at the signalized intersections. The running time is the total time that the vehicle spends on the street and is influenced by, the street’s classification, the segment length, and side street friction.

To make sure that the model utilized under future conditions was accurate, D&A first created the traffic model in Synchro for existing conditions. The Synchro data base files that were created for the existing conditions were imported into the SimTraffic Simulation software. Five (5) simulation runs were conducted for the existing conditions to review the models forecasted travel speeds for the corridor. The results of the Synchro and SimTraffic model runs for existing conditions were compared to the average travel speeds collected in the field in order to validate the model.

Review of the Synchro and SimTraffic model runs to the average travel speeds collected in the field found that the Synchro model was more comparable to the actual field data and was thus utilized to calculate the Year 2030 travel speeds. The 2030 average travel speeds and associated levels of service are summarized in Table 4-3.

Future Conditions Assessment

Table 4-3 – Forecast Year 2030 Average Travel Speeds					
Segment	Direction of Travel	AM Peak Hour		PM Peak Hour	
		Average Travel Speed (mph)	LOS	Average Travel Speed (mph)	LOS
Scenario 1 – With Existing Roadway Network					
University Avenue – 54 th St. to College Ave.	Eastbound	18.3	D	18.1	D
	Westbound	20.9	D	20.2	D
University Avenue – College Ave. to Salvation Dwy.	Eastbound	24.7	C	23.1	C
	Westbound	16.1	E	12.6	F
University Avenue – 54 th St. to Salvation Dwy.	Eastbound	20.6	D	19.9	D
	Westbound	18.5	D	16.0	E
Scenario 2 – With Deletion of Chollas Parkway Connection to University Avenue					
University Avenue – 54 th St. to College Ave.	Eastbound	18.3	D	18.1	D
	Westbound	21.0	D	19.8	D
University Avenue – College Ave. to Salvation Dwy.	Eastbound	24.7	C	23.1	C
	Westbound	16.1	E	12.6	F
University Avenue – 54 th St. to Salvation Dwy.	Eastbound	20.6	D	20.0	D
	Westbound	18.5	D	15.9	E

As shown in Table 4-3, with or without the deletion of the Chollas Parkway connection to University Avenue, under 2030 conditions the segment of University Avenue between College Avenue and Salvation Driveway operates at LOS E in the westbound direction during the AM peak hour and LOS F in the westbound direction during the PM peak hour. The University Avenue Corridor as a whole between 54th Street and Salvation Driveway is projected to operate at LOS D in the eastbound direction during both peak hours, and LOS D in the westbound direction during the AM peak hour and LOS E in the westbound direction during the PM peak hour.



4.3 PEDESTRIAN ANALYSIS

As discussed previously, the pedestrian activity along the University Avenue Corridor was estimated to increase by 25%. The future Year 2030 pedestrian crossings during the AM and PM peak periods was previously illustrated in Figure 4-9. Table 4-4 provides a summary of the 2030 pedestrian crossing data by intersection leg. It should be noted that the volume of pedestrian crossings are not anticipated to be impacted by the deletion of the Chollas Parkway connection to University Avenue. Thus the pedestrian volumes illustrated in Figure 4-9 and depicted in Table 4-4 would be applicable for either the Scenario 1 (existing roadway network) or Scenario 2 (the deletion of the Chollas Parkway connection to University Avenue) roadway network alternatives.

As shown in Table 4-4 the following seven (7) intersections are anticipated to have more than 100 pedestrian crossings during the peak AM or PM peak period:

- University Avenue/54th Street – 490 AM, 360 PM
- University Avenue/Chollas Parkway – 60 AM, 110 PM
- University Avenue/58th Street – 140 AM, 240 PM
- University Avenue/University Square Driveway – 80 AM, 200 PM
- University Avenue/60th Street – 70 AM, 120 PM
- University Avenue/College Avenue – 200 AM, 390 PM
- University Avenue/Rolando Boulevard – 80 AM, 120 PM

Based on 2011 pedestrian data, there were only four (4) intersections (University Avenue at 54th Street, 58th Street, University Square Driveway, and College Avenue) where pedestrian crossings exceeded 100 during the AM or PM peak period. The increase in pedestrian activity warrants further evaluation to ensure that pedestrian capacity on sidewalks is being met.

As discussed in the existing conditions reports, focus for future pedestrian improvements include locations with existing obstructions or missing sidewalks, locations with a history of pedestrian related crashes, and locations with high transit activity. Specific improvements that are considered to address pedestrian access and walkability are discussed in future sections of this report.



UNIVERSITY AVENUE MOBILITY STUDY

Table 4-4 - Summary of Year 2030 Pedestrian Volumes

Intersection	West Leg	North Leg	East Leg	South Leg	Total
AM Peak Period (6:30 AM - 9:00 AM)					
University Ave. (E-W) @ 54th St. (N-S)	80 (University Ave.)	90 (54th St.)	180 (University Ave.)	140 (54th St.)	490
University Ave. (E-W) @ Chollas Pkwy. (N-S)	20 (University Ave.)	0 (Chollas Pkwy.)	10 (University Ave.)	30 (Chollas Pkwy.)	60
University Ave. (E-W) @ 58th St. (N-S)	30 (University Ave.)	30 (58th St.)	50 (University Ave.)	30 (58th St.)	140
University Ave. (E-W) @ University Sq. (N-S)	10 (University Ave.)	0 (University Sq.)	30 (University Ave.)	40 (University Sq.)	80
University Ave. (E-W) @ 60th St. (N-S)	10 (University Ave.)	10 (60th St.)	40 (University Ave.)	10 (60th St.)	70
University Ave. (E-W) @ College Ave. (N-S)	40 (University Ave.)	50 (College Ave.)	50 (University Ave.)	60 (College Ave.)	200
University Ave. (E-W) @ Rolando Blvd. (N-S)	20 (University Ave.)	10 (Rolando Blvd.)	40 (University Ave.)	10 (Rolando Blvd.)	80
University Ave. (E-W) @ Aragon Dr. (N-S)	10 (University Ave.)	10 (Aragon Dr.)	10 (University Ave.)	30 (Aragon Dr.)	60
University Ave. (E-W) @ Salvation Dwy. (N-S)	20 (University Ave.)	0 (Salvation Dwy.)	10 (University Ave.)	10 (Salvation Dwy.)	40
Chollas Pkwy.(E-W) @ 54th St. (N-S)	0 (Chollas Pkwy.)	10 (54th St.)	20 (Chollas Pkwy.)	10 (54th St.)	40
Total along University Ave.:	240	200	420	360	1,220
PM Peak Period (3:30 PM - 6:00 PM)					
University Ave. (E-W) @ 54th St. (N-S)	90 (University Ave.)	70 (54th St.)	70 (University Ave.)	130 (54th St.)	360
University Ave. (E-W) @ Chollas Pkwy. (N-S)	20 (University Ave.)	0 (Chollas Pkwy.)	20 (University Ave.)	70 (Chollas Pkwy.)	110
University Ave. (E-W) @ 58th St. (N-S)	30 (University Ave.)	60 (58th St.)	110 (University Ave.)	40 (58th St.)	240
University Ave. (E-W) @ University Sq. (N-S)	20 (University Ave.)	0 (University Sq.)	90 (University Ave.)	90 (University Sq.)	200
University Ave. (E-W) @ 60th St. (N-S)	20 (University Ave.)	10 (60th St.)	60 (University Ave.)	30 (60th St.)	120
University Ave. (E-W) @ College Ave. (N-S)	120 (University Ave.)	50 (College Ave.)	80 (University Ave.)	140 (College Ave.)	390
University Ave. (E-W) @ Rolando Blvd. (N-S)	10 (University Ave.)	20 (Rolando Blvd.)	60 (University Ave.)	30 (Rolando Blvd.)	120
University Ave. (E-W) @ Aragon Dr. (N-S)	10 (University Ave.)	10 (Aragon Dr.)	10 (University Ave.)	20 (Aragon Dr.)	50
University Ave. (E-W) @ Salvation Dwy. (N-S)	20 (University Ave.)	0 (Salvation Dwy.)	0 (University Ave.)	10 (Salvation Dwy.)	30
Chollas Pkwy. (E-W) @ 54th St. (N-S)	0 (Chollas Pkwy.)	10 (54th St.)	30 (Chollas Pkwy.)	10 (54th St.)	50
Total along University Ave.:	340	220	500	560	1,620

Future Conditions Assessment



4.4 BICYCLE ANALYSIS

As discussed previously, the bicycle activity along the University Avenue Corridor was estimated to increase by 100%. The Year 2030 bicycle crossings during the AM and PM peak periods was previously illustrated in Figure 4-9. Table 4-5 provides a summary of the 2030 bicycle crossing data by intersection leg. It should be noted that the volume of bicycle crossings are not anticipated to be impacted by the deletion of the Chollas Parkway connection to University Avenue. Thus the bicycle volumes illustrated in Figure 4-9 and depicted in Table 4-5 would be applicable for either the Scenario 1 (existing roadway network) or Scenario 2 (the deletion of the Chollas Parkway connection to University Avenue) roadway network alternatives.

As shown in Table 4-5, the University Avenue/54th Street and University Avenue/Chollas Parkway intersections are the only intersections projected to have more than 100 bicycle crossings during the AM or PM peak periods. The University Avenue/54th Street intersection is projected to have 120 bicycle crossings during the AM peak period and 190 bicycle crossings during the PM peak period. The University Avenue/Chollas Parkway intersection is projected to have 80 bicycle crossings during the AM peak period and 120 bicycle crossings during the PM peak period. All other intersections are projected to have 80 or fewer bicycle crossings during the AM or PM peak periods.

It should be noted, however, that the Year 2030 bicycle crossings were based on a growth of 100% from the existing bicycle travel patterns along University Avenue. The existing bicycle travel patterns are based on the existing bicycle network which does not have any bike lanes, bikeways, or posted bike routes along the University Avenue Corridor. Both the Mid-Cities Community Plan and the City of San Diego's Bicycle Master Plan (Project 27); however, identify Class II Bike Lanes along the University Avenue Corridor. If bicycle lanes were to be added along University Avenue the bicycle patterns/activity along University Avenue may be impacted (i.e. they may increase in some areas more than others) as it may become a more desirable route for bicyclers.

Specific improvements that are considered to address the bicycle network/connectivity are discussed in future sections of this report.

Future Conditions Assessment



UNIVERSITY AVENUE MOBILITY STUDY

Table 4-5 - Summary of Year 2030 Bicycle Volumes

Intersection	West Leg	North Leg	East Leg	South Leg	Total
AM Peak Period (6:30 AM - 9:00 AM)					
University Ave. (E-W) @ 54th St. (N-S)	20 (University Ave.)	30 (54th St.)	40 (University Ave.)	30 (54th St.)	120
University Ave. (E-W) @ Chollas Pkwy. (N-S)	10 (University Ave.)	40 (Chollas Pkwy.)	0 (University Ave.)	30 (Chollas Pkwy.)	80
University Ave. (E-W) @ 58th St. (N-S)	10 (University Ave.)	30 (58th St.)	10 (University Ave.)	10 (58th St.)	60
University Ave. (E-W) @ University Sq. (N-S)	10 (University Ave.)	20 (University Sq.)	0 (University Ave.)	20 (University Sq.)	50
University Ave. (E-W) @ 60th St. (N-S)	10 (University Ave.)	20 (60th St.)	10 (University Ave.)	20 (60th St.)	60
University Ave. (E-W) @ College Ave. (N-S)	10 (University Ave.)	20 (College Ave.)	10 (University Ave.)	20 (College Ave.)	60
University Ave. (E-W) @ Rolando Blvd. (N-S)	10 (University Ave.)	20 (Rolando Blvd.)	10 (University Ave.)	10 (Rolando Blvd.)	50
University Ave. (E-W) @ Aragon Dr. (N-S)	10 (University Ave.)	30 (Aragon Dr.)	10 (University Ave.)	10 (Aragon Dr.)	60
University Ave. (E-W) @ Salvation Dwy. (N-S)	10 (University Ave.)	20 (Salvation Dwy.)	10 (University Ave.)	10 (Salvation Dwy.)	50
Chollas Pkwy.(E-W) @ 54th St. (N-S)	20 (Chollas Pkwy.)	10 (54th St.)	20 (Chollas Pkwy.)	0 (54th St.)	50
Total along University Ave.:	100	230	100	160	590
PM Peak Period (3:30 PM - 6:00 PM)					
University Ave. (E-W) @ 54th St. (N-S)	40 (University Ave.)	50 (54th St.)	50 (University Ave.)	50 (54th St.)	190
University Ave. (E-W) @ Chollas Pkwy. (N-S)	0 (University Ave.)	60 (Chollas Pkwy.)	0 (University Ave.)	60 (Chollas Pkwy.)	120
University Ave. (E-W) @ 58th St. (N-S)	20 (University Ave.)	20 (58th St.)	10 (University Ave.)	10 (58th St.)	60
University Ave. (E-W) @ University Sq. (N-S)	20 (University Ave.)	20 (University Sq.)	0 (University Ave.)	30 (University Sq.)	70
University Ave. (E-W) @ 60th St. (N-S)	10 (University Ave.)	20 (60th St.)	10 (University Ave.)	30 (60th St.)	70
University Ave. (E-W) @ College Ave. (N-S)	10 (University Ave.)	30 (College Ave.)	10 (University Ave.)	20 (College Ave.)	70
University Ave. (E-W) @ Rolando Blvd. (N-S)	10 (University Ave.)	30 (Rolando Blvd.)	20 (University Ave.)	20 (Rolando Blvd.)	80
University Ave. (E-W) @ Aragon Dr. (N-S)	10 (University Ave.)	30 (Aragon Dr.)	10 (University Ave.)	20 (Aragon Dr.)	70
University Ave. (E-W) @ Salvation Dwy. (N-S)	10 (University Ave.)	20 (Salvation Dwy.)	10 (University Ave.)	20 (Salvation Dwy.)	60
Chollas Pkwy.(E-W) @ 54th St. (N-S)	10 (Chollas Pkwy.)	10 (54th St.)	20 (Chollas Pkwy.)	20 (54th St.)	60
Total along University Ave.:	130	280	120	260	790

Future Conditions Assessment



4.5 TRANSIT ANALYSIS

As previously discussed, based on discussions with MTS, future transit ridership was estimated based on an annual growth rate of 1% per year for a total growth of 19% by the Year 2030. Table 4-6 provides a breakdown by route of the average projected ridership for the Year 2030. As illustrated in Table 4-6 by the Year 2030, Route 7 is anticipated to have a total of 3,100 trip ends (1,510 eastbound, 1,590 westbound) while Route 10 is anticipated to have a total of 730 trip ends (520 eastbound, 210 westbound). The existing bus supply should be able to adequately accommodate the additional transit ridership.

Table 4-6 - Summary of Year 2030 Transit Daily Ridership for University Avenue Corridor							
Route	Direction of Travel	Year 2011 Ridership			Year 2030 Ridership		
		Boarding's	Alightings	Trip Ends	Boarding's	Alightings	Trip Ends
7	Eastbound	373	889	1,262	450	1,060	1,510
	Westbound	991	343	1,334	1,180	410	1,590
Route 7 Total		1,364	1,232	2,596	1,630	1,470	3,100
10	Eastbound	44	385	429	60	460	520
	Westbound	150	20	170	180	30	210
Route 10 Total		194	405	599	240	490	730
Corridor Total		1,558	1,637	3,195	1,870	1,960	3,830

As discussed previously, Route 10 is anticipated to improve such that the headways will be decreased from 15 minutes down to 10 minutes. This results in an increase in the number of buses from approximately four (4) buses per hour per direction to six (6) buses per hour per direction (a total increase of 4 buses). If the headways for Route 7 were to also be improved from the existing 12 minute headway to a 10 minute headway, this increase the number of buses from approximately five (5) buses per hour per direction to six (6) buses per hour per direction (a total increase of 4 buses).

As summarized in Section 4.2 of this document the segment of University Avenue between College Avenue and Salvation Driveway is projected to operate at LOS E in the westbound direction during the AM peak hour and LOS F during the PM peak hour under 2030 conditions regardless of whether the Chollas Parkway connection to University Avenue is deleted. Similarly, by the year 2030, the University Avenue/College Avenue intersection is also forecasted to operate at LOS F during the PM peak hour. If the Chollas Parkway connection to University Avenue is deleted the University Avenue/54th Street intersection will also operate at LOS F during the PM peak hour. These changes to traffic operations will have a direct impact on the operations of transit operations along the corridor. Slower run times and longer wait times for buses will result in impacts to bus on-time performance.

Coupling the demand for transit based on ridership with the forecast traffic flow conditions along the corridor, considerations for improving transit along the corridor warrant consideration.

4.6 SUMMARY OF FUTURE CONDITIONS ASSESSMENT

Based on the analysis conducted, the critical circulation locations are:

- **Intersection Improvements:** Assuming no changes to the existing roadway network were made by the Year 2030 (Scenario 1), the University Avenue/College Avenue intersection is forecasted to operate at LOS D during the AM peak hour and LOS F during the PM peak hour. In addition, unsignalized intersections of University Avenue/Chollas Parkway and Chollas Parkway/54th Street which have critical movements that operate at LOS E or F under existing conditions will continue to have critical movements which operate at LOS F during the morning and/or afternoon peak hour in the Year 2030.

Future Conditions Assessment



If the Chollas Parkway connection to University Avenue is deleted (Scenario 2), the University Avenue/54th Street intersection will operate at LOS D during the AM peak hour and LOS F during the PM peak hour by the Year 2030. Further, the level of service at the Chollas Parkway/54th Street will improve to an acceptable LOS B during both the AM and PM peak hours. All other intersections will continue to operate the same as they would under Scenario 1.

Since the deletion of the Chollas Parkway connection to University Avenue has a negative impact at the University Avenue/54th Street intersection (i.e. it lowered the level of service from an acceptable to an unacceptable level), this alternative was removed from consideration when developing the mobility plan for the University Avenue Mobility Study area.

- **Arterial Segment Improvements:** With or without the deletion of the Chollas Parkway connection to University Avenue, under 2030 conditions the segment of University Avenue between College Avenue and Salvation Driveway operates at LOS E in the westbound direction during the AM peak hour and LOS F in the westbound direction during the PM peak hour. The University Avenue Corridor as a whole between 54th Street and Salvation Driveway is projected to operate at LOS D in the eastbound direction during both peak hours, and LOS D in the westbound direction during the AM peak hour and LOS E in the westbound direction during the PM peak hour. Specific improvements that are considered to improve the arterial levels of service are discussed in future sections of this report.
- **Pedestrian Walkability and Accessibility:** Seven (7) intersections are anticipated to have more than 100 pedestrian crossings during the peak AM or PM peak period. Based on 2011 pedestrian data, there were only four (4) intersections where pedestrian crossings exceeded 100 during the AM or PM peak period. The increase in pedestrian activity warrants further evaluation to ensure that pedestrian capacity on sidewalks is being met. Focus for future pedestrian improvements include locations with existing obstructions or missing sidewalks, locations with a history of pedestrian related crashes, and locations with high transit activity. Specific improvements that are considered to address pedestrian access and walkability are discussed in future sections of this report.
- **Bicycle Facilities:** The University Avenue/54th Street and University Avenue/Chollas Parkway intersections are projected to have more than 100 bicycle crossings during the AM or PM peak periods. Currently there are no designated bicycle facilities (i.e. bike lanes or signed bike routes) along University Avenue to accommodate this bicycle demand. Both the Mid-Cities Community Plan and the City of San Diego's Bicycle Master Plan; however, identify Class II Bike Lanes along the University Avenue Corridor. Therefore, a primary focus of the University Avenue Mobility Study is to provide some type of bicycle facility along the University Avenue Corridor that will help achieve the goals of the community plan and make the community feel a little safer riding their bikes along University Avenue.
- **Transit Accessibility/Amenities:** Based on discussions with MTS, future transit ridership is anticipated to grow at a rate of 1% per year for a total growth of 19% by the Year 2030. The existing bus supply should be able to adequately accommodate the additional transit ridership. However, since the projected arterial travel speeds along University Avenue were forecasted to degrade to an unacceptable level by the Year 2030, consideration was given to providing priority to transit vehicles such that their operating performance will not degrade in the future as traffic volumes increase. Additionally, a review of all existing transit stops were conducted to determine whether relocating some of the stops could provide better accessibility. Specific improvements at and adjacent to bus stops are shown on the plan options and discussed in future sections of this report.