

# Street Lighting



*–Street Lights shall be provided in accordance with the approved Council Policy 200-18, Street Lighting.*



# Street Lighting -Street Lights

## Street Lights

1. Street lighting shall be installed at all street intersections and shall conform to Table L-1. All street lighting shall be high-pressure sodium vapor (HPS) except for areas which are designated for low pressure sodium vapor (LPS). Contact the Development Services Department for current information.
2. Midblock street lighting shall be installed as follows:
  - a. On residential and collector streets, staggered at intervals not to exceed 150 feet (45m) within 1,320 feet (400 m) of transit stops and in residential and commercial high-crime census tracts, or in other areas staggered at intervals not to exceed 300 feet (90 m).
  - b. On Four-Lane Urban Major Streets or higher with center medians, on both sides of the street at intervals not to exceed 150 feet (45 m) within 1,3020 feet (400 m) of transit stops and in residential and commercial high-crime census tracts, or in other areas on both sides of the street at intervals not to exceed 300 feet (90m).
  - c. Near the end of cul-de sacs that exceed 150 feet (45m) within 1,320 feet (400 m) of transit stops and in residential and commercial high-crime census tracts, or in other areas near the end of cul-de-sacs that exceed 200 feet (60 m) in length.
  - d. One light on each side of the street at at-grade railroad crossings to illuminate the side of the train facing the motorist.
  - e. In areas of high pedestrian activity, such as schools, parks, transit centers, access to transit, and commercial and recreational facilities that draw large numbers of pedestrians.
  - f. At other locations, such as at abrupt changes in horizontal or vertical alignment, or areas of heavy pedestrian use, as needed.
3. Agriculture-zoned or natural open space land may be exempted from midblock street lighting provisions, at the directions of the City Engineer.
4. Midblock street lighting shall be full cutoff, Type III fixtures and shall conform to the following:
  - a. 100 Watt HPS or 55 Watt LPS, as applicable, in alleys.
  - b. 150 Watt HPS, or 90 Watt LPS, as applicable, for local residential streets (any width) and streets classified as collector or higher with curb-to-curb width up to and including 40 feet (12.2 m).
  - c. 250 Watt HPS or 135 Watt LPS, as applicable, for streets classified as collector or higher with curb-to-curb width greater than 40 feet (12.2m) up to and including 52 feet (16.0m).
  - d. 250 Watt HPS or 180 Watt LPS, as applicable, for streets classified as collector or higher with curb-to-curb width greater than 52 feet (16.0 m).
5. Supplemental street lighting, for: a) ornamental, b) continuous street lighting, or c) pedestrian-scale lighting purposes, shall be installed in street lighting assessment districts. Street lighting assessment districts will be formed only upon the request of the properties which will be included in the district.
  - a. Ornamental street lighting shall be designed to meet the desires of the street lighting assessment district. Custom poles, luminaries, and spacing may be used.
  - b. Continuous street lighting shall conform to RP-8, "American National Standard Practice for Roadway Lighting," or the Illuminating Engineering Society of North America.

**Table L-1  
Street Lighting at Non-Signalized Intersections\***

Street A  Street B	B1 Local residential streets (any width) and collector or higher streets up to and including 40 ft. wide, curb-to-curb	B2 Collector or higher streets greater than 40 ft. and up to and including 52 ft. wide, curb-to-curb	B3 Collector or higher streets greater than 52 ft. wide, curb-to-curb
A1 Local residential streets (any width) and collector or higher streets up to and including 40 ft. wide, curb-to-curb	(A1-b1) Install one 150 W. HPS or 90 W. LPS light, as applicable, on the far right corner of the higher volume street.	(Same as A2-B1)	(Same as A3-B1)
A2 Collector or higher streets greater than 40 ft. and up to and including 52 ft. wide, curb-to-curb	(A2-B1) Install one 250 W. HPS or 135 W. LPS light, as applicable, on each of the far right corners of the wider street.	(A2-B2) Install one 250 W. HPS or 135 W. LPS light, as applicable, on each of the far right corners of the higher volume street.	(Same as A3-B2)
A3 Collector or higher streets greater than 52 ft. wide, curb-to-curb	(A3-B1) Install one 250 W. HPS or 180 W. LPS light, as applicable, on each of the far right corners of the wider street, and 150 W. HPS or 90 W. LPS light, as applicable, on each of the far right corners of the narrower street.	(A3-B2) Install one 250 W. HPS or 180 W. LPS light, as applicable, on each of the far right corners of the wider street, and one 250 W. HPS or 135 W. LPS light, as applicable, on each of the far right corners of the narrower street.	(A3-B3) Install one 250 W. HPS or 180 W. LPS light, as applicable, on each of the far right corners of the intersection.

\* Energy and maintenance costs are provided by the City.

**NOTES:**

1. Street lighting fixtures shall be HPS or LPS full cutoff, Type III.
2. Street lighting standards and mounting heights shall conform to City of San Diego Standard Drawing SDE-101.
3. Street Lighting at signalized intersections shall conform to the Caltrans Traffic Manual.



# Street Lighting *-Intersection Lighting*

## c. Pedestrian Scale Lighting

Where pedestrian-scale lighting is installed, sidewalk or walkway lighting shall provide adequate lighting for pedestrians of all abilities and shall conform to the following:

1. In commercial areas, the average maintained horizontal illuminance (FC) on the sidewalk or walkway shall not be less than 0.9 foot-candles and shall not exceed illuminance uniformity ratio (UR) of 4:1 ( $FC_{Avg} : FC_{Min}$ ).
2. In mixed-use areas, the average maintained horizontal illuminance on the sidewalk or walkway shall not be less than 0.6 foot-candles and shall not exceed UR of 4:1 ( $FC_{Avg} : FC_{Min}$ ).
3. In residential areas, the average maintained horizontal illuminance on the sidewalk or walkway shall not be less than 0.4 foot-candles and shall not exceed UR of 6:1 ( $FC_{Avg} : FC_{Min}$ ).
4. In commercial areas, contributions from other nearby storefront lighting, private lighting, sign lighting and/or reflections from structures on private property should not be considered as a reason for reducing the sidewalk or walkway illuminance levels indicated above.
5. Sidewalk or walkway lights shall have cutoff fixtures that keep light pollution, light trespass, and glare to drivers to a minimum, as approved by the City Engineer. Manufacturer models for sidewalk and walkway lighting shall be approved by the City Engineer.
6. Agriculture-zoned land or open space may be exempt, at the discretion of the City Engineer, from pedestrian scale lighting provisions.
7. Further design guidelines can be found in the RP-8 publication of the Illuminating Engineering Society of North America, "American National Standard Practice for Roadway Lighting."

# Urban Parkway Configurations





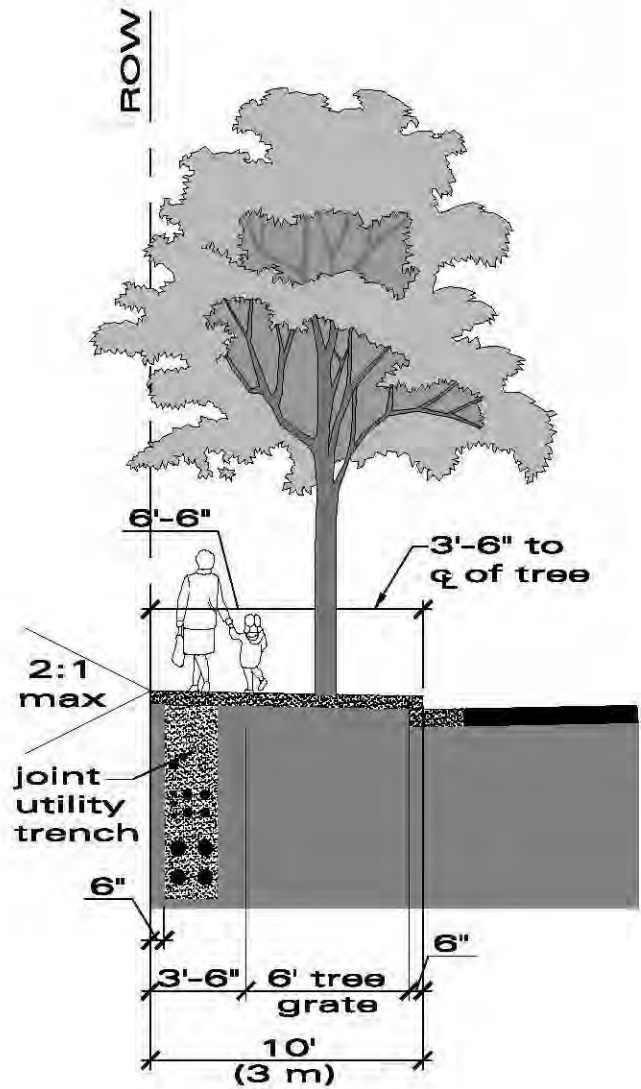
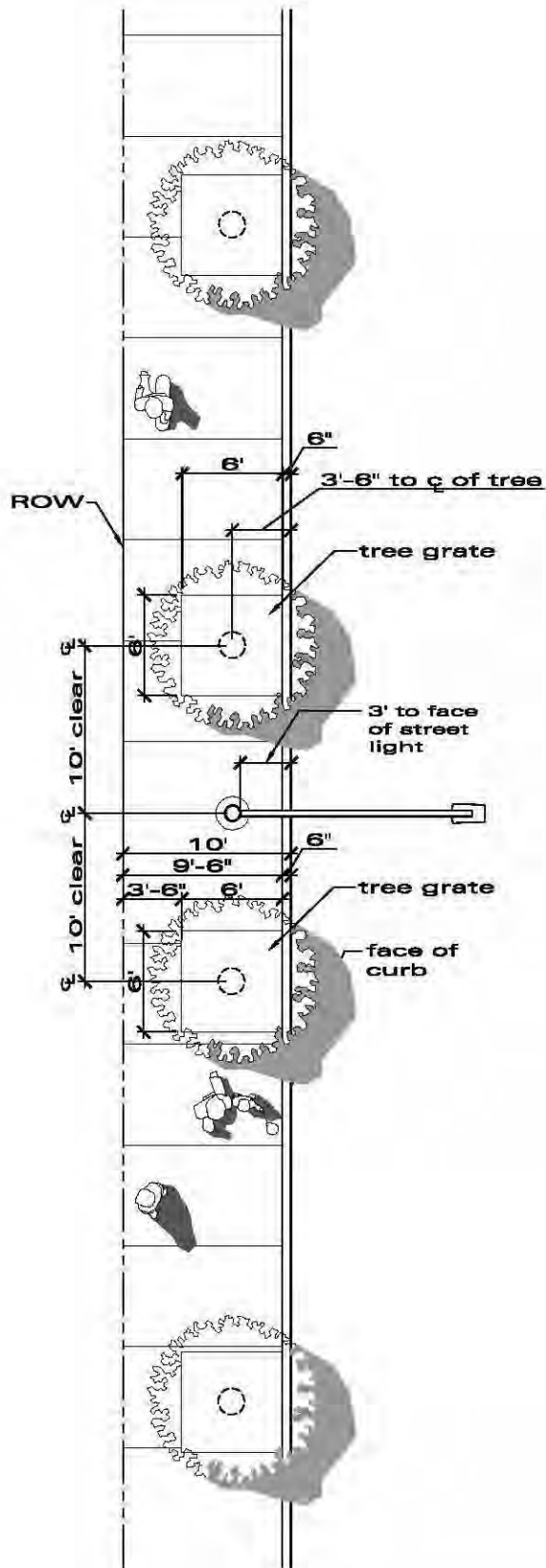

**U-2**



# Urban Parkway Configurations

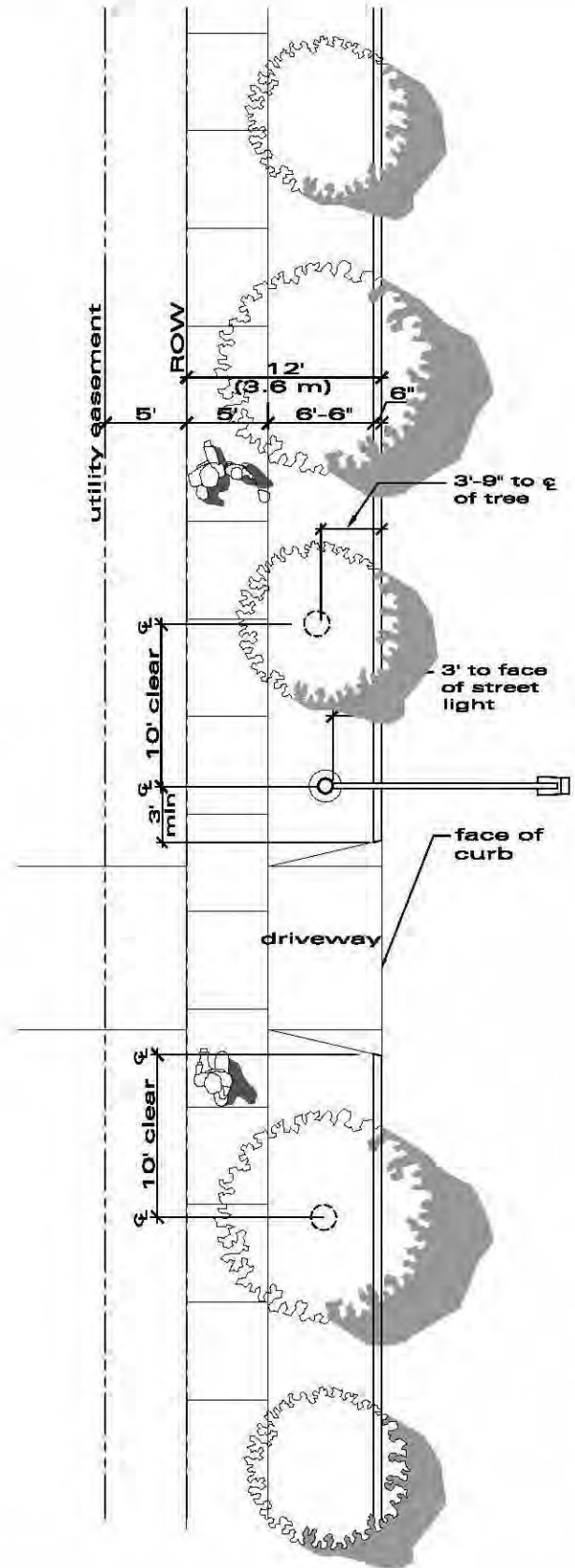
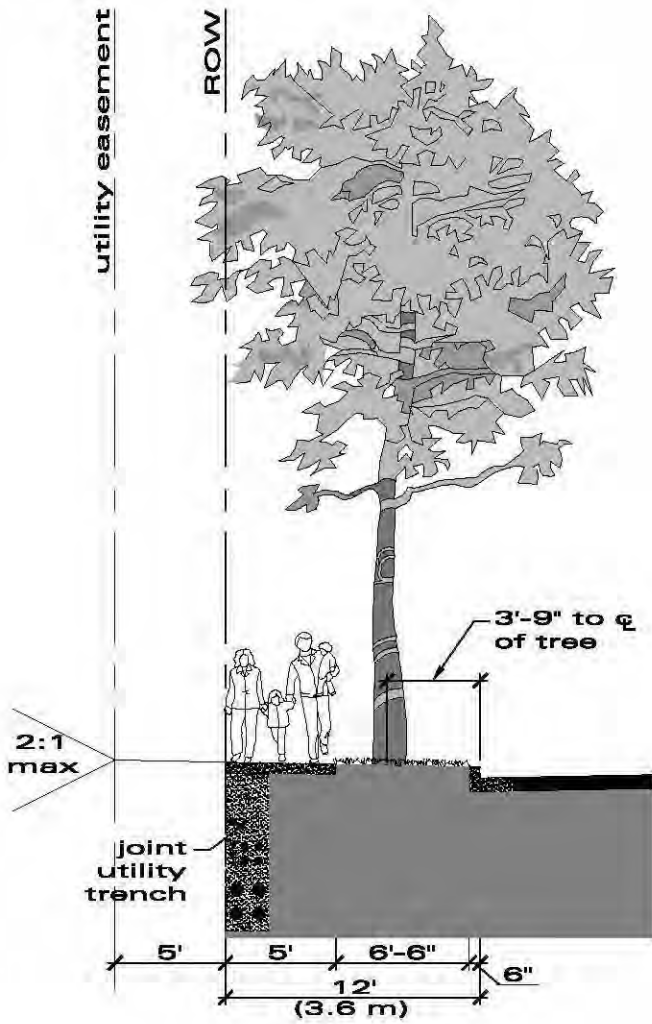

**U-3**



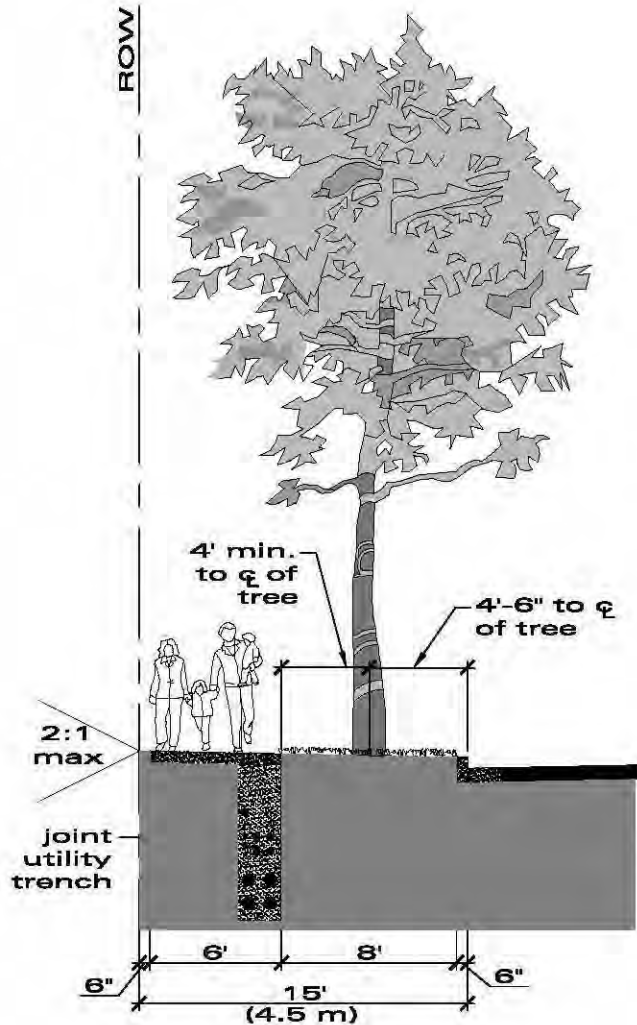
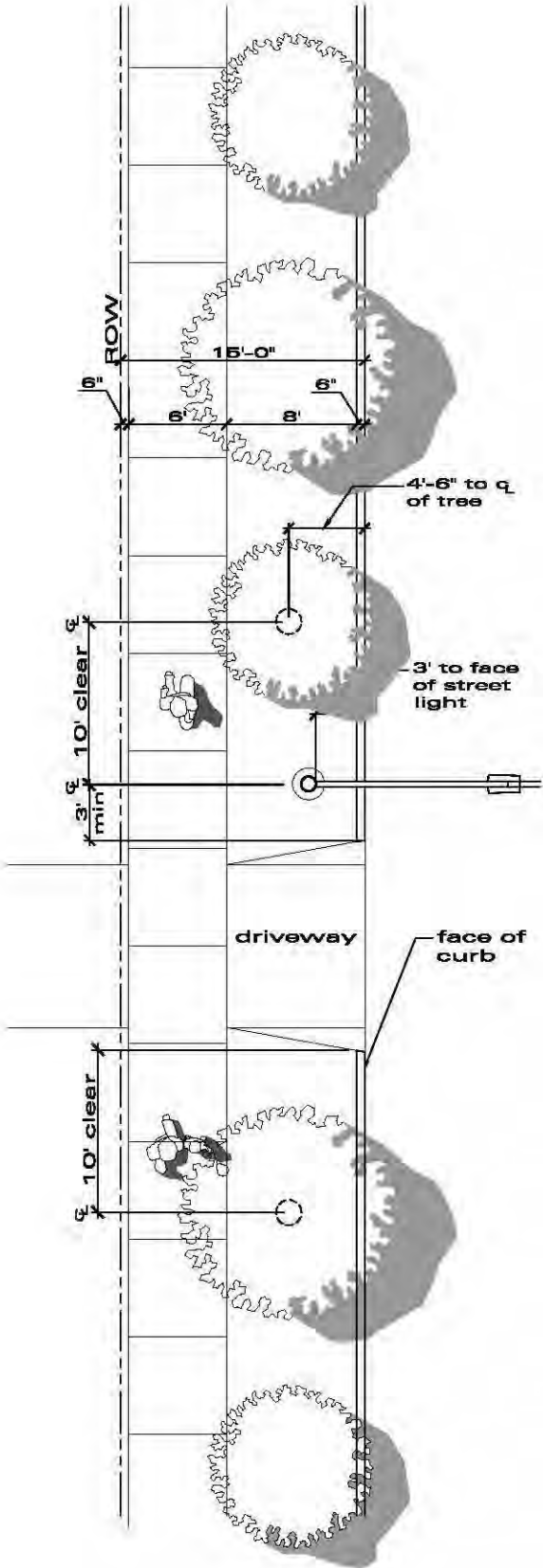

**U-4**  
**a**



# Urban Parkway Configurations

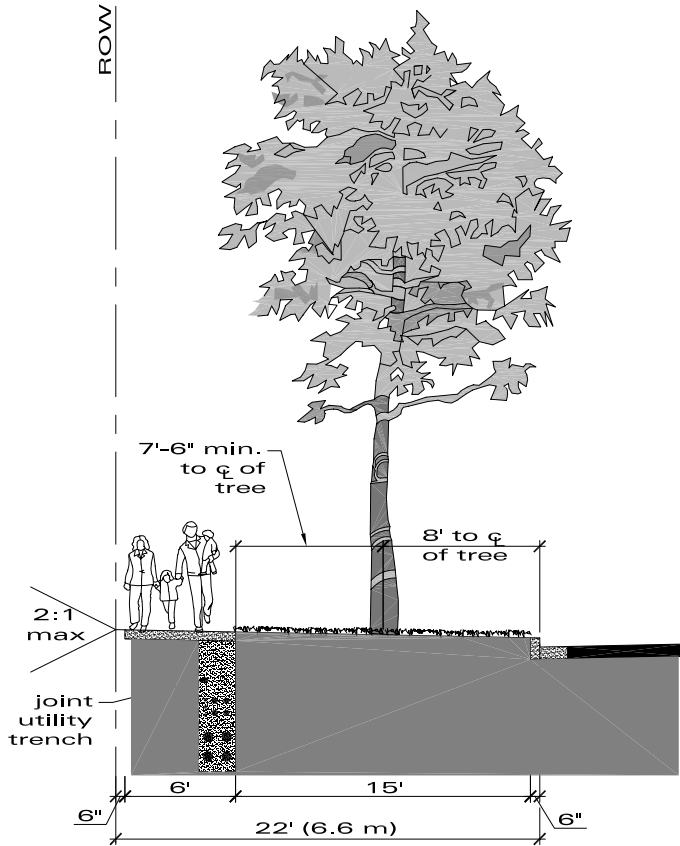

\* Alternative configuration of sidewalk and landscape strip may be installed subject to approval of the city engineer.

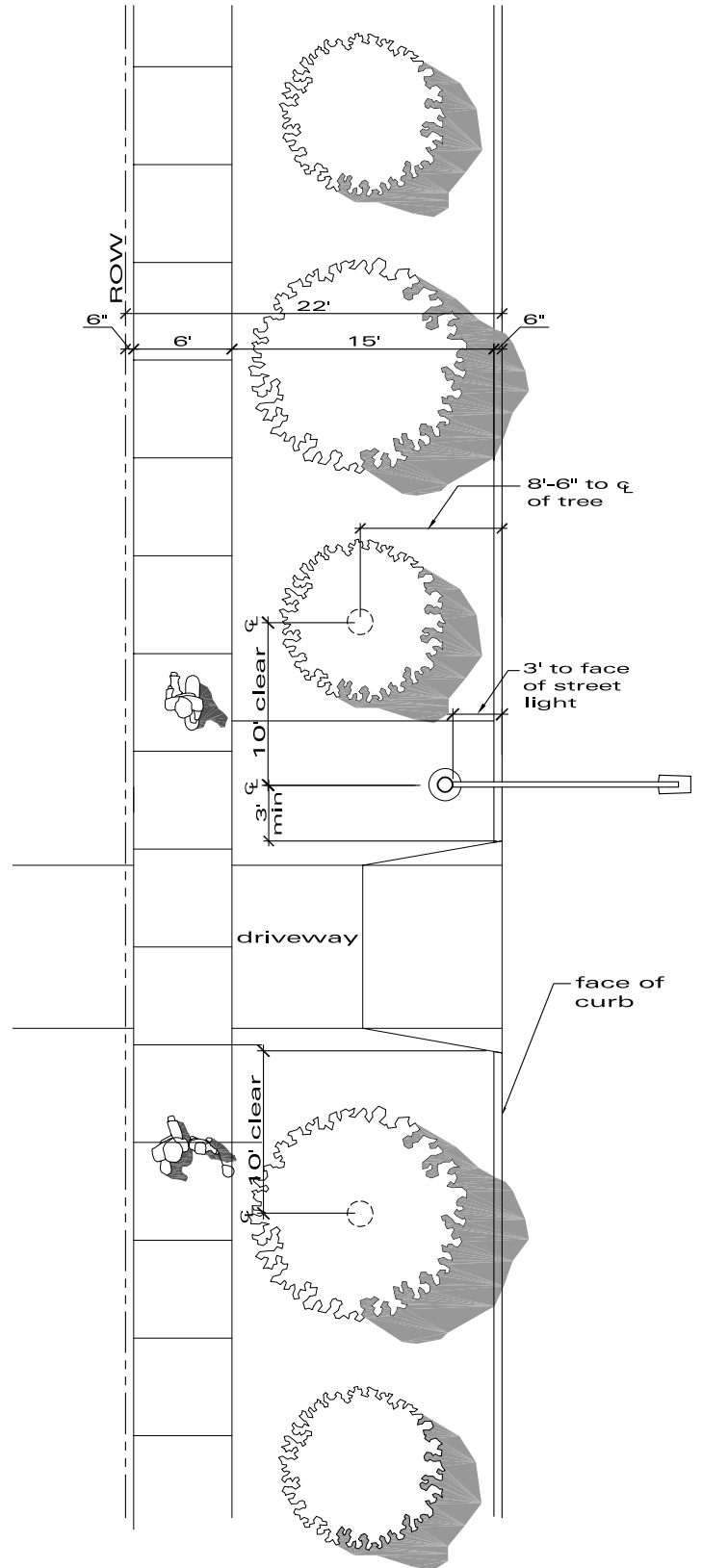

**U-4  
b**

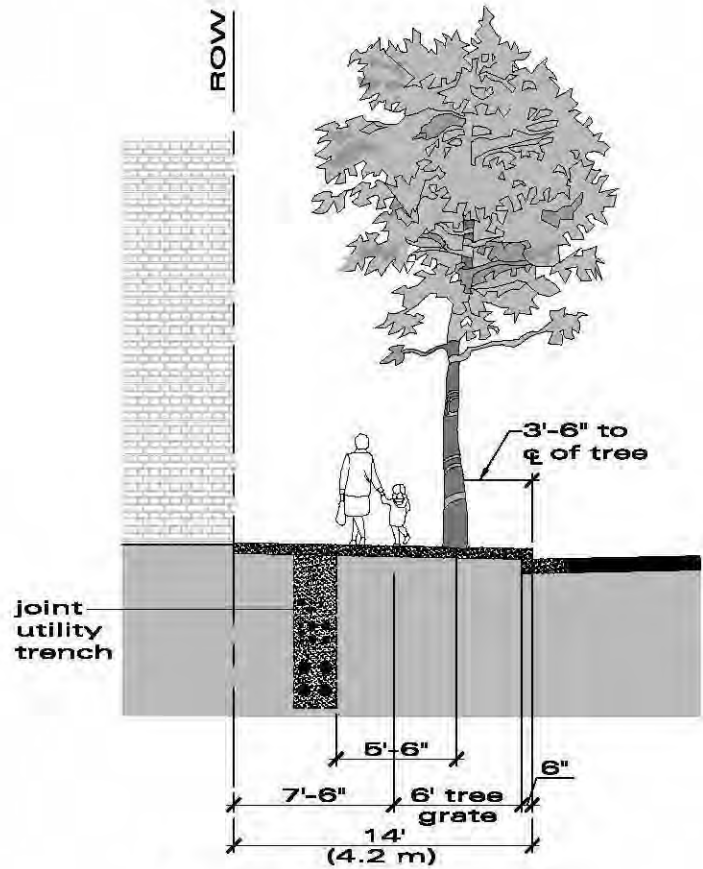
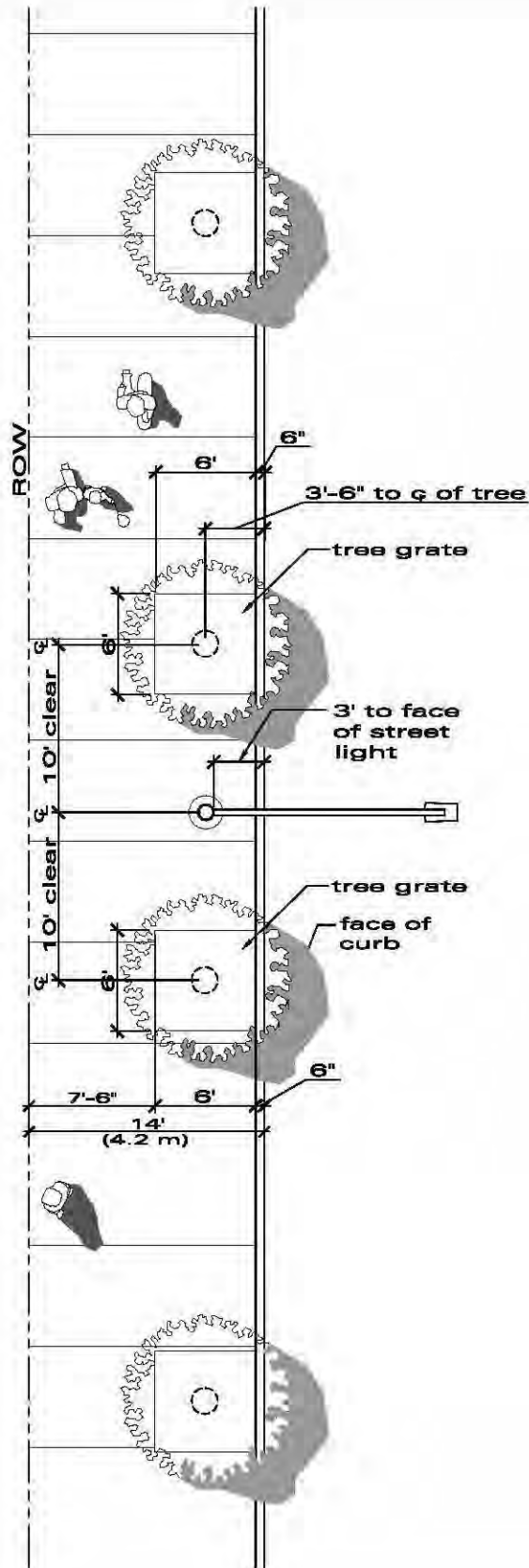

\* Where storefront furniture is provided, the clear pedestrian passage way shall not be less than 5'-0".

**U-5**  
**a**



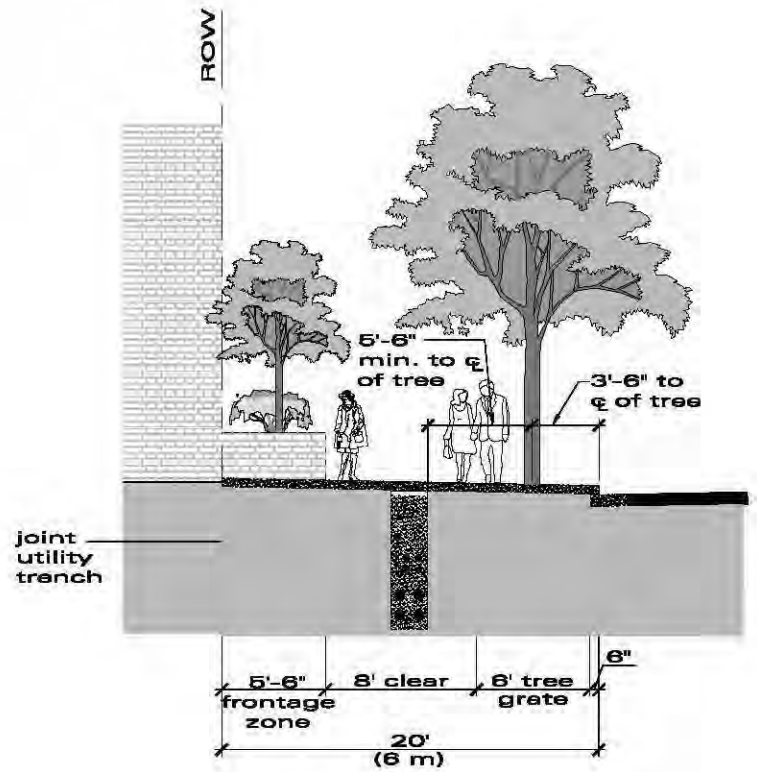
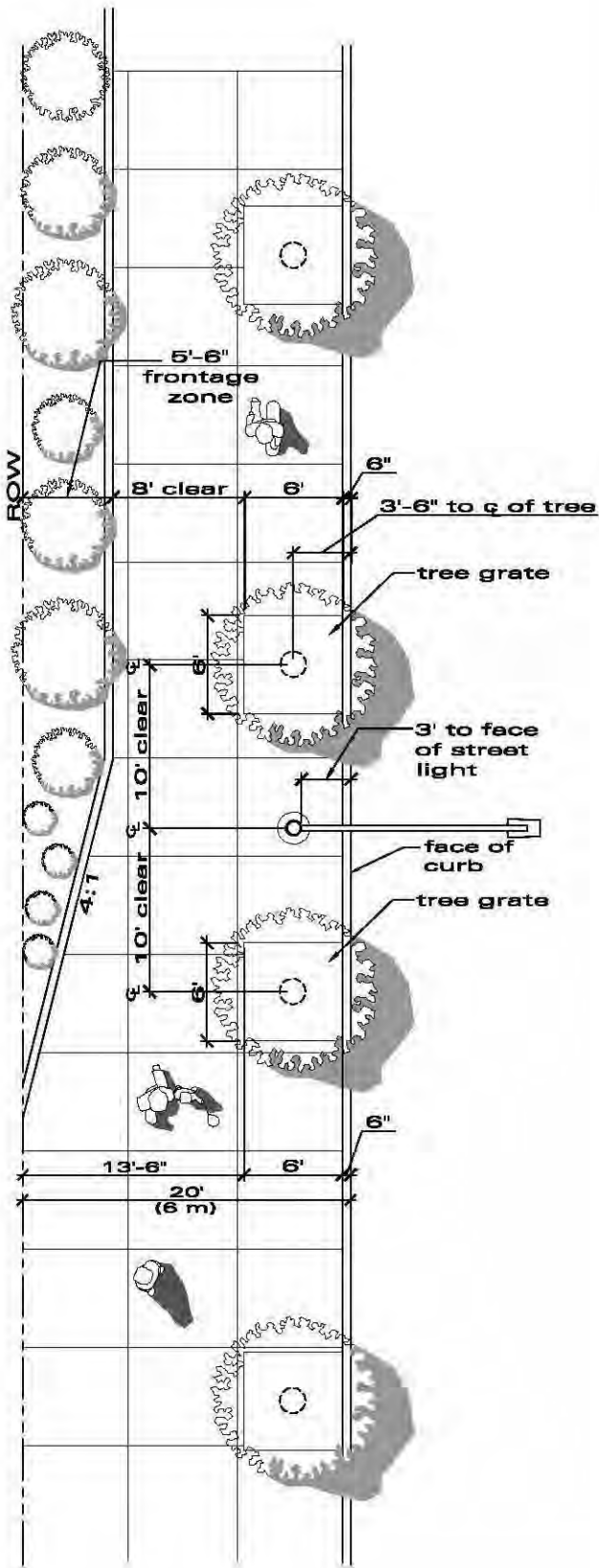

\* Where storefront furniture is provided, the clear pedestrian passage way shall not be less than 8'-0".





# Urban Parkway Configurations

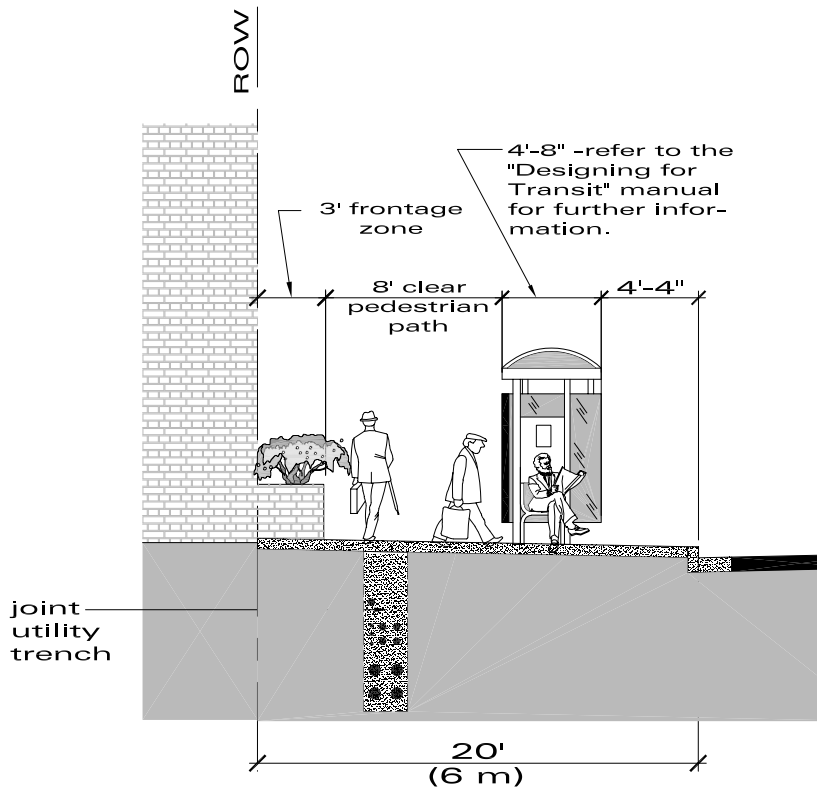

\* Where storefront furniture is provided, the clear pedestrian passage way shall not be less than 8'-0".

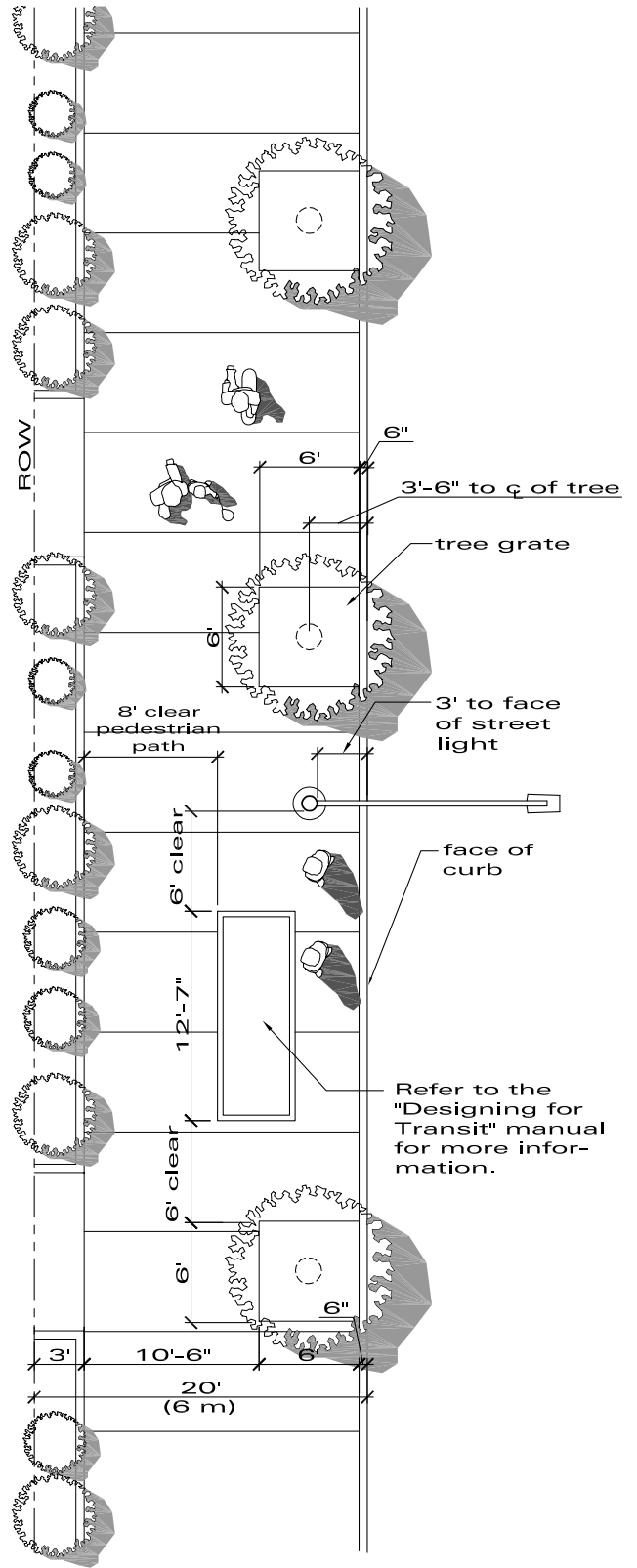

**U-6  
b**

# **Rural Parkway Configurations**





# Rural Parkway Configurations

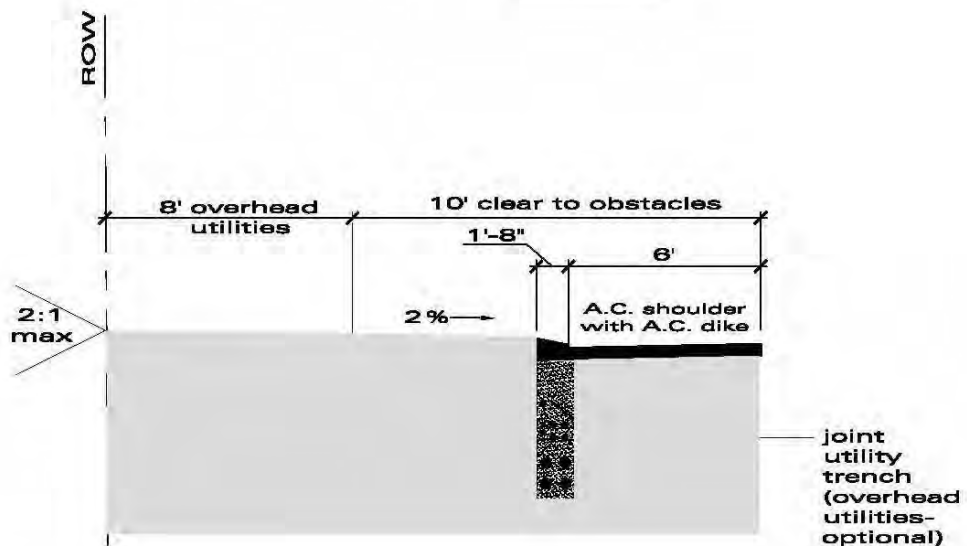
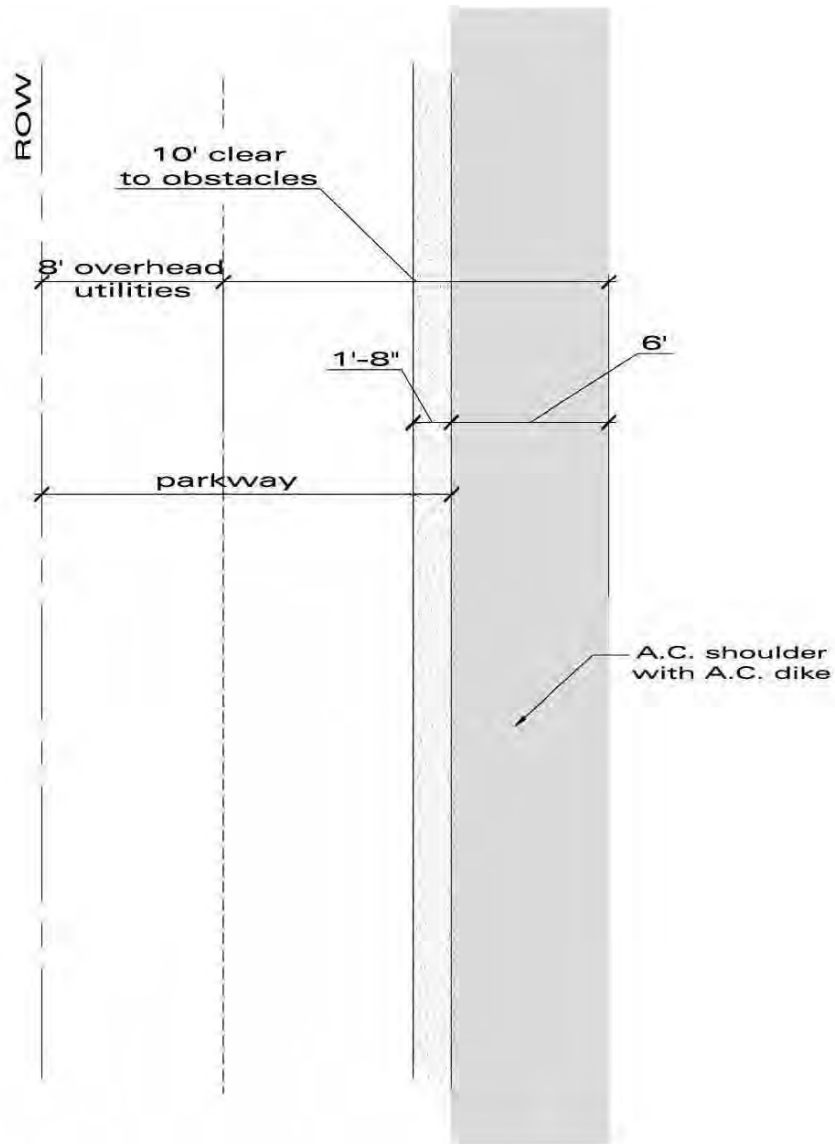

**R-1**



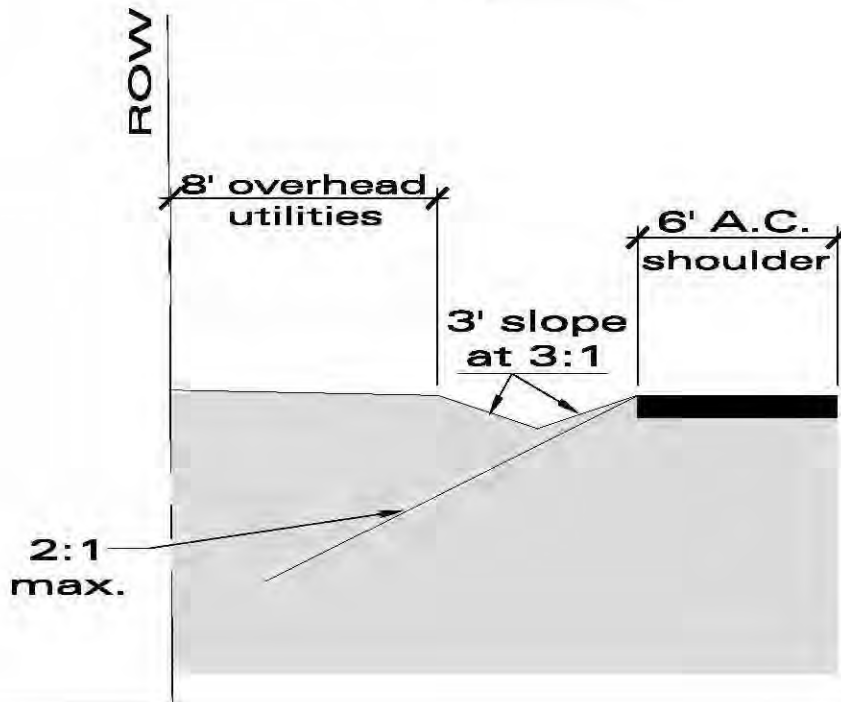
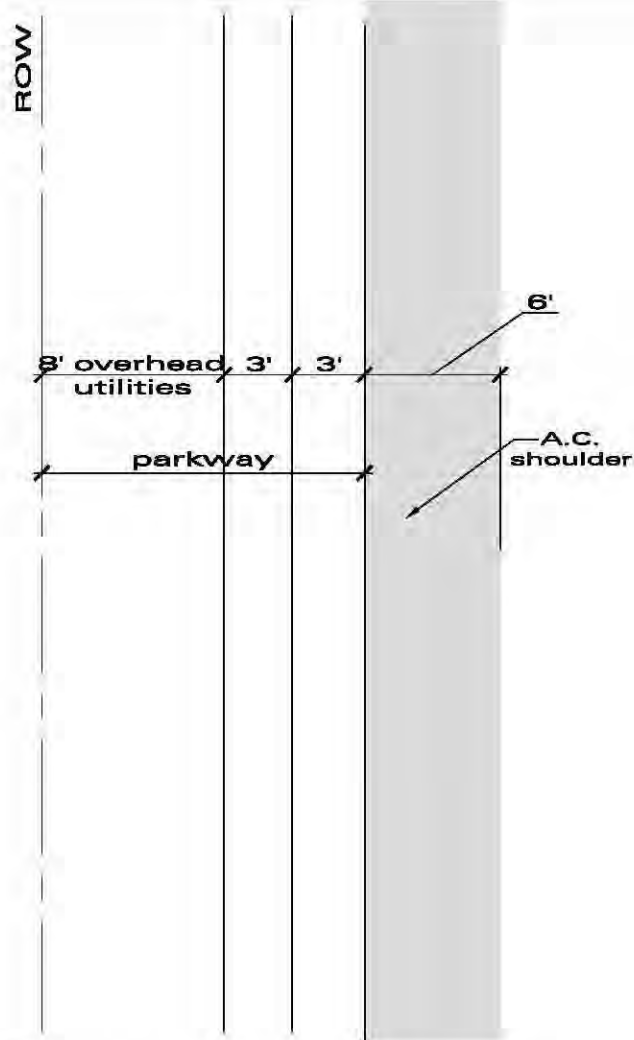

**R-2**  
**a**



# Rural Parkway Configurations

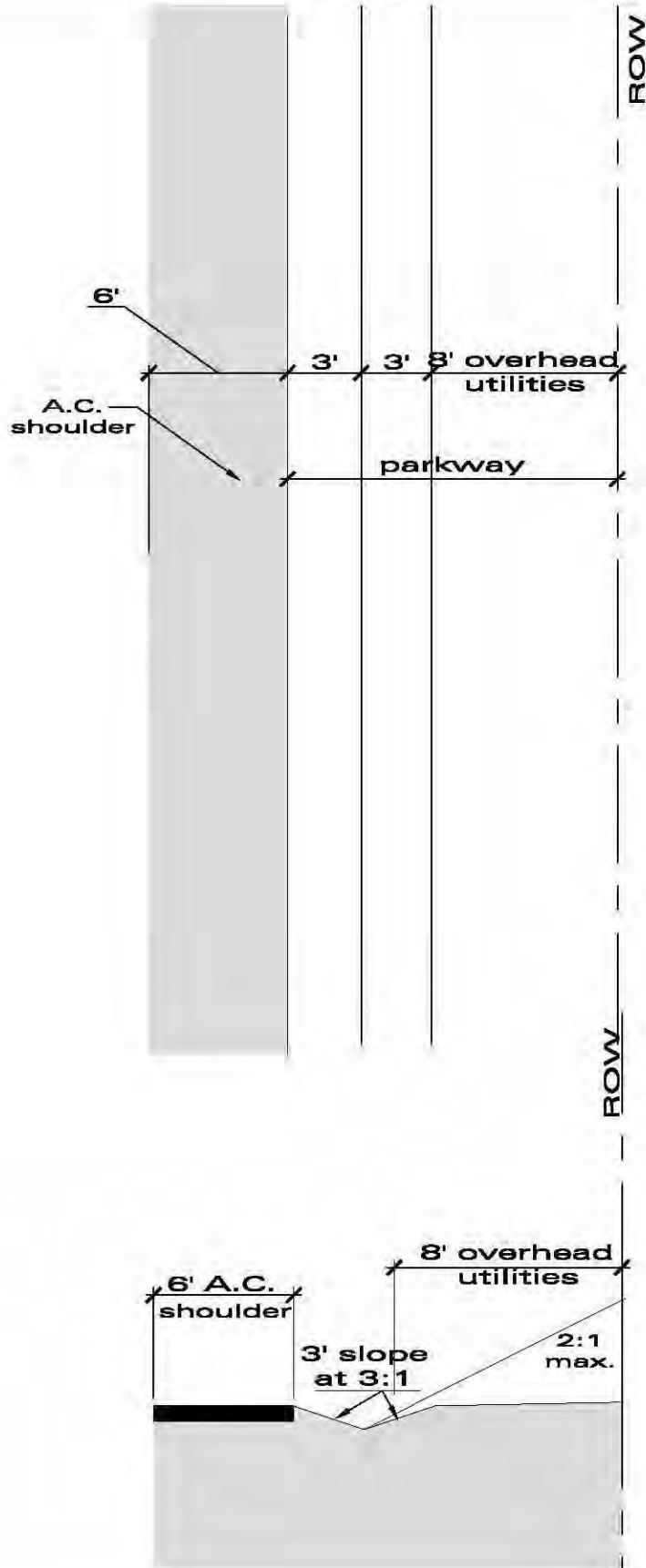

**R-2  
b**

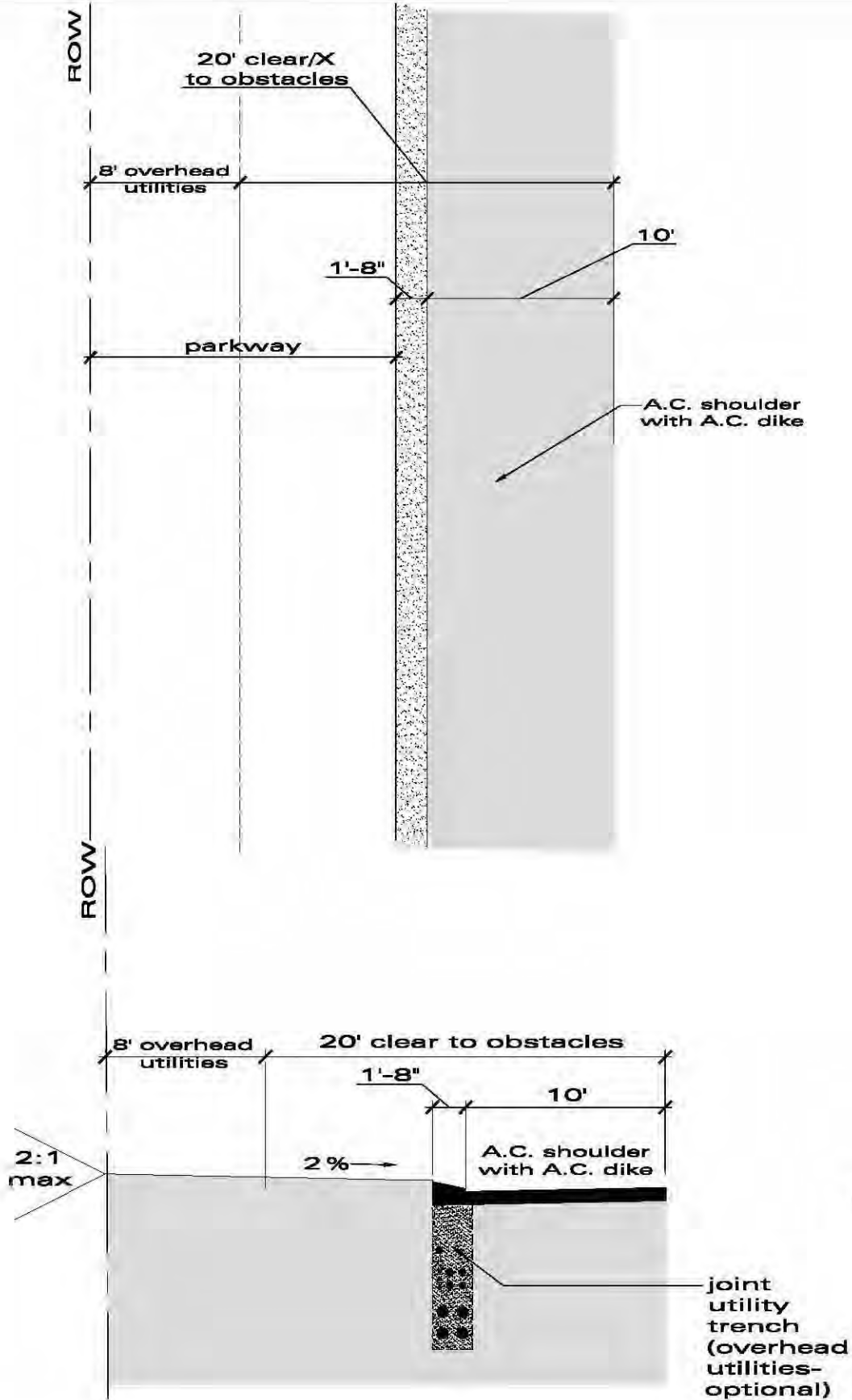

**R-3**



# Rural Parkway Configurations

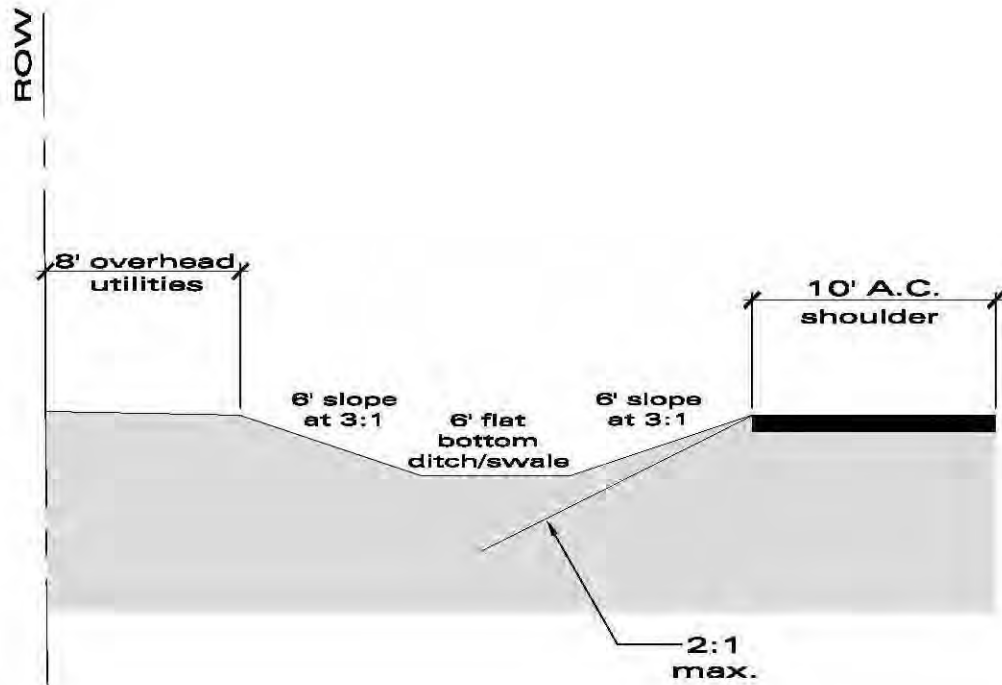
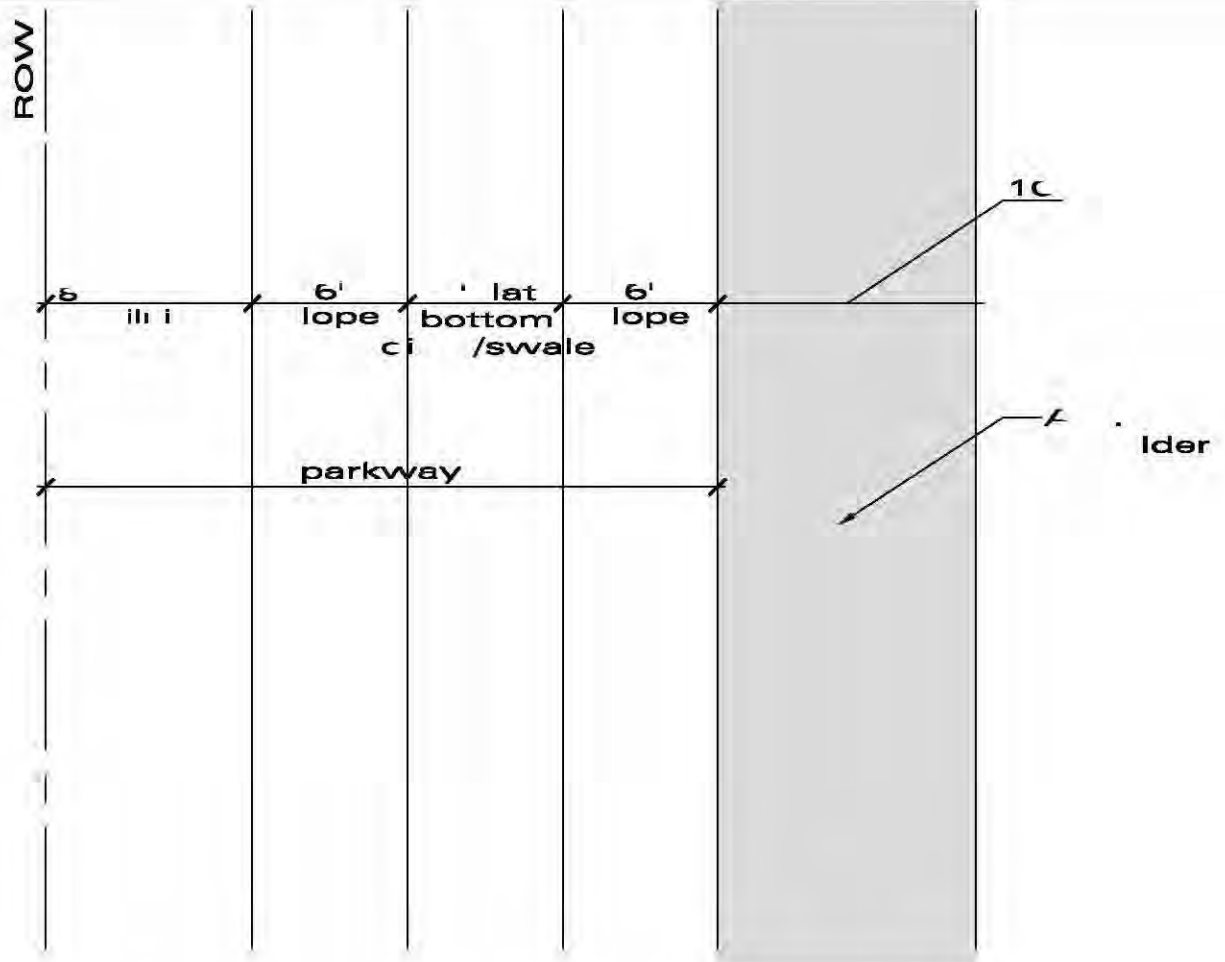

**R-4**