

City of San Diego



Aqua 2030 Research Center

Final Report

***City of San Diego
Advanced Water Treatment
Research Studies***

August 2007



MWH
MONTGOMERY WATSON HARZA

CITY OF SAN DIEGO
ADVANCED WATER TREATMENT
RESEARCH STUDIES

FINAL REPORT

August 2007

Prepared For:

City of San Diego

Prepared By:

MWH

TABLE OF CONTENTS

List of Tables	i
List of Figures	ii
List of Acronyms and Abbreviations	iii
Glossary of Terms	v
1. Executive Summary	1
2. Introduction	7
2.1. Water Repurification Project.....	7
2.2. Developments in Indirect Potable Reuse.....	8
2.3. Water Reuse Study 2005	9
2.4. Project Objectives.....	9
3. Materials and Methods.....	11
3.1. AWT Pilot Treatment Trains.....	11
3.2. Experimental Plans.....	12
3.2.1. RO Integrity Monitoring (Train #1).....	12
3.2.2. AWT Performance Evaluation (Train #2)	13
3.2.3. UV Spiking Study (Train #2).....	14
3.3. Laboratory Resources.....	15
4. Results and Discussion.....	16
4.1. RO Integrity Monitoring (Train #1)	16
4.1.1. Phase I Results	16
4.1.2. Phase II Results.....	17
4.1.3. Phase III Results	18
4.2. AWT Performance Evaluation (Train #2).....	18
4.2.1. Water Quality Data	18
4.2.2. AWT Product Water Quality Comparison.....	20
4.2.3. Reverse Osmosis Operational Performance Data	23
4.3. UV Spiking Study (Train #2)	24
5. Summary and Conclusions.....	25
References.....	27
APPENDIX A: Correspondence City of San Diego Water Quality Laboratory	A-1
APPENDIX B: Correspondence MWH Laboratories.....	B-1
APPENDIX C: Correspondence SNWA Research Laboratory	C-1
APPENDIX D: Technical Memorandum AWT Product Water Quality Comparison.....	D-1

List of Tables

Table 1: Identification of Various RO Integrity Monitoring Techniques.....	29
Table 2: Operating Conditions of Various Unit Processes of the AWT Pilot Train	29
Table 3: EDC/PPCP Target List.....	30
Table 4: Target EDC and PPCP.....	31
Table 5: Water Quality Results (City of San Diego Water Quality Laboratory)	32
Table 6: Water Quality Results (MWH Laboratory).....	38
Table 7: Water Quality Results (SNWA Research Laboratory).....	43
Table 8: Primary Drinking Water Standards for Measured Organic Parameters	44
Table 9: Primary Drinking Water Standards for Measured Inorganic Parameters.....	45
Table 10: Secondary Drinking Water Standards for Measured Parameters	46
Table 11: CDHS Drinking Water Notification Levels for 21 Compounds	47
Table 12: EDC and PPCP Spiking Experiment Results (w/hydrogen peroxide)	48

List of Figures

Figure 1: Schematic Diagram of the Advanced Water Treatment Train (Proposed 2005)	49
Figure 2: Schematic of the Water Reuse Pilot Study Layout	50
Figure 3: RO Integrity Monitoring Plan	51
Figure 4: Vacuum Decay Test Results of RO Membranes from Various Suppliers	52
Figure 5: Sulfate Rejection Results of RO Membranes from Various Suppliers	53
Figure 6: MS2 Phage Seeding Experiment Results from Various Suppliers	54
Figure 7: MS2 Phage Seeding Experiment Results Single VS. Two Stage System.....	54
Figure 8: Sulfate Rejection Results Single Stage VS. Two Stage System	55
Figure 9: TRASAR Rejection Results	55
Figure 10: RO Membrane Performance (Saehan 4040 BLR).....	56
Figure 11: Results from UV Collimated Beam Testing for NDMA Destruction.....	57
Figure 12: EEO values of the spiked NDMA, EDC and PPCPs Treated with UV/Peroxide.....	57

List of Acronyms and Abbreviations

AOP	Advanced Oxidation Process
ASTM	American Standard Technical Method
AWT	Advanced Water Treatment
BAT	Best Available Technology
CB	Collimated Beam
CDHS	California Department of Health Services
CDWR	California Department of Water Resources
DBP	Disinfection byproducts
EDC	Endocrine Disrupting Compounds
EEO	Electrical Energy order
FD&C	Food, Drug and Cosmetic
FWR	Feed Water Recovery
gfd	gallons per square foot per day
gpm	gallon per minute
gpd	gallon per day
IC	ion chromatography
L/h	liters per hour
LRV	log removal value
MCL	maximum contaminant level
MDL	method detection limit
MF	microfiltration
MGD	million gallons per day
mg/L	milligram per liter
µg/L	microgram per liter
MFG	manufacturer
MWD	Metropolitan Water District of Southern California
MWH	Montgomery Watson Harza
MS2	(see glossary)
NCWRP	North City Water Reclamation Plant
ND	not detected
NDMA	N-nitrosodimethylamine
ng/L	nanogram per liter
NTU	Nephelometric Turbidity Unit
PCPP	Pharmaceuticals and Personal Care Products
ppm	parts per million
ppb	parts per billion
ppt	parts per trillion
RO	reverse osmosis
RW	reclaimed water
SBWRF	South Bay Water Reclamation Facility
SDI	Silt Density Index
SDCWA	San Diego County Water Authority
SDWD	City of San Diego Water Department
SPWRF	San Pasqual Water Reclamation Facility

SNWA	Southern Nevada Water Authority
TDS	Total dissolved solids
TTHMs	Total trihalomethanes
TMP	Transmembrane pressure
TLD	Trace Leak Detection
UF	Ultrafiltration
USEPA	United States Environmental Protection Agency
UV	Ultraviolet

Glossary of Terms

Aerobic - Requiring oxygen.

Advanced Oxidation Process (AOP) – Water treatment process, which involves generating powerful hydroxyl radicals to destroy a wide variety of organic contaminants. Typical AOP processes used in water/wastewater treatment applications include: hydrogen peroxide/UV radiation; ozone/hydroxide, ozone/hydrogen peroxide and ozone/UV radiation.

Anaerobic - Not requiring oxygen.

Anion - Negative ions that migrate to the positive electrode in an electrolytic solution.

Atomic weight - Approximately the number of protons and neutrons in the nucleus of an element.

Bench scale experiment - small-scale experiment (i.e. <1gpm) normally conducted in a laboratory as a screening tool to determine performance of given treatment technology.

Best Available Technologies –best known methods of reducing contaminant levels to meet MCL, as specified by the USEPA and CDHS.

Cation - A positive ion that migrates to the negative electrode in an electrolytic solution.

Challenge experiments – experiment used to determine the ability of a treatment system (typically membranes) to reject a selected contaminant. During this type of experiment a known quantity of a select contaminant is added or spiked to the water entering the system. The contaminant is then measured in the water entering and exiting the system to determine removal efficacy.

Chloramine - Compounds of chlorine and ammonia (e.g. NH_2Cl , NHCl_2 , or NCl_3).

Collimated beam apparatus - An ideal lab-scale reactor consisting of a shallow, well-mixed batch reactor exposed to UV radiation at uniform intensity. This device is used characterize the delivered dose of the larger scale UV systems.

Conductivity an estimate of the amount of total dissolved salts (TDS), or the total amount of dissolved ions in water.

Contaminants of Concern - see definition of **notification levels**.

EDC- endocrine disrupting compound- The USEPA has defined an EDC as “an exogenous agent that interferes with the synthesis, secretion, transport, binding action or elimination of natural hormones in the body, that are responsible for the maintenance of homeostasis, reproduction, development and/or behavior”.

Effluent – Water which flows out of a process.

EEO - electrical energy order – amount of energy required to destroy 1 log order (i.e. 90%) of a given contaminant per 1000 gallons of water treated. EEO values are both reactor and water quality specific and therefore it is necessary to utilize collimated beam results to “calibrate” the pilot-scale reactor so a particular set of operating conditions can be translated to a delivered dose.

Feed - Water entering a treatment process.

Feed Water Recovery – the amount of feed water (%) which exits an RO system as product water. Calculated as $(\text{Feed Flow} - \text{Permeate Flow} / \text{Feed Flow}) * 100\%$.

Flux – expression of productivity in membrane systems. Equivalent to the amount of permeate flow (gallons) produced per day per unit area of membrane (ft²). units = gallons/ft²-day (gfd). For example a membrane system containing 1530 ft² area which produces 17 gpm would be operating with a flux = 16 gfd.

Grab sample - A single sample collected at a particular time and place that represents the composition of the water, air, or soil only at that time and place (USEPA).

Inorganic Compounds – compounds which are not organic. Inorganic compounds come principally from mineral sources of non-biological origin. The modern definition of inorganic compounds often includes all metal-containing compounds, even those found in living systems.

Although most carbon compounds are classed as organic, cyanide salts, carbon oxides and carbonates are usually considered to be inorganic (Wikipedia encyclopedia 2006).

Indirect Potable Reuse (IPR): The blending of advanced treated recycled water into a natural water source (groundwater basin or reservoir) that could be used for drinking (potable) water after further treatment.

Influent - Flow entering a process.

Ions - Atoms that have lost or gained one or more electrons, giving them a charge.

Log removal value (LRV)- represents the level of contaminant removal by a given treatment process expressed in units of 10. Determined by $-\log \{ \text{effluent/influent} \}$. For example, 99 % removal is equivalent to 2 log removal ; 99.9% = 3 log; 99.99% = 4 log etc.

Maximum Contaminant Level (MCL) - The highest level of a contaminant that is allowed in drinking water. Primary MCLs are set close to the PHGs (or MCLGs) as economically or technologically feasible. Secondary MCLs are set to protect the odor taste and appearance of drinking water.

Maximum Contaminant Level Goal (MCLG) – the level of a contaminant in drinking water below which there is no known or expected risk to health. MCLGs are set by the EPA.

MDL EPA definition “ the minimum concentration of a substance that can be measured and reported with 99% confidence that the analyte concentration is greater than zero and is determined from analysis of a sample in a given matrix containing the analyte”.

Molecular weight - The sum of the atomic weights of all atoms in the molecule.

Membrane fouling – The International Union of Pure and Applied Chemistry defines fouling as follows: “The process that results in a decrease in performance of a membrane, caused by the deposition of suspended or dissolved solids on the external membrane surface, on the membrane pores, or within the membrane pores”.

MS2 Phage – A non-human pathogen similar in size (0.025 microns), shape (icosahedron) and nucleic acid (RNA) to polio virus and hepatitis virus. Because MS2 is not a human pathogen, live MS2 is commonly used for membrane challenge testing experiments.

Notification Level – Health based advisory levels established by the CDHS for compounds which do not have MCLs. In general notification levels have been established for “contaminants of concern” (i.e. perchlorate, NDMA, 1,4 dioxane) which have been found in or anticipated to occur drinking water supplies. Currently there are 30 compounds with notification levels. When these compounds are detected above their established notification levels requirements and recommendations apply.

NDMA -*N*-Nitrosodimethylamine (NDMA) is a semi-volatile, yellow, oily liquid of low viscosity that has been extensively used in industry for several decades (USEPA, 2001).

Organic compounds - a large class of chemical compounds whose molecules contain carbon, with the exception of carbides, carbonates, and carbon oxides.

Permeate - Water which has passed through a membrane process such as RO or UF.

pH - A measure of a solution’s hydrogen ion concentration (acidity).

Photolysis – As defined by the American Meteorology Society, “The process by which a chemical species undergoes a chemical change as the result of the absorption of a photon of light”.

Pilot – A small capacity system used to assess the performance of a full-scale system. In the field of water/wastewater treatment pilot systems normally have production rates of 30 gpm or less and are designed using similar components to that used in full-scale applications. Operation of a pilot system prior to full-scale design allows operators to assess system performance on a given feed water source, optimize operating parameters, assess water quality performance and gain experience/familiarity with the given process.

Potable – Water, which is suitable for drinking per federal and state drinking water regulations.

Public Health Goal (PHG) – The level of a contaminant in drinking water below which there is no known or expected risk to health. PHGs are set by the California EPA.

Reverse Osmosis – a membrane process which removes contaminants such as solids, protozoa, bacteria, viruses and most organic molecules, metals and salts from water or other solvents. The process works by applying external pressure on the feed side of semi-permeable membrane which allows water (or other solvent) to the permeate side of the membrane.

Recovery – see feed water recovery.

Rejection – amount (%) of a contaminant which is removed by a water treatment system (typically membrane process). Percent rejection of contaminant X is calculated as $(\{\text{Feed Concentration of X} - \text{Permeate Concentration of X}\} / \{\text{Feed Concentration}\} \text{ of X})$.

Stage – Term used to describe the configuration of RO systems. RO systems can be configured as single stage, two stage or three stage. When RO systems are built with multiple stages concentrate or brine water from the previous stage is used as feed water to next stage. This configuration allows the feedwater recovery of the overall RO system to increase.

Spiking – process in which a known quantity of given contaminant is added to the feed of a treatment system.

Specific flux – flux per unit pressure (gfd/psi).

Total Dissolved Solids (TDS): A measure of the amount of material dissolved in water (mostly inorganic salts). An important use of the measure involves the examination of the quality of drinking water. Usually expressed in milligrams per liter (mg/l).

Total Organic Carbon (TOC) - TOC has no health effects. However, TOC provides a medium for the formation of disinfection by-products. These by-products include trihalomethanes

(THMs) and haloacetic acids (HAAS). Drinking water containing these by-products in excess of the MCL may lead to adverse health effects, liver or kidney problems, or nervous system effects, and may lead to an increased risk of cancer.

Title 22 Treatment (Title 22) A method of tertiary wastewater treatment approved by CDHS for many water reuse applications. Title 22, Chapter 4, of the California Code of Regulations, outlines the level of treatment required for allowable uses for recycled water, including irrigation, fire fighting, residential landscape watering, industrial uses, food crop production, construction activities, commercial laundries, road cleaning, recreational purposes, decorative fountains, and ponds.

TCEP – Tris (2-chloroethyl) phosphate is an additive flame retardant, which is used in thermoset and thermoplastic resins. It is an effective flame retardant in urea-melamine, urea-formaldehyde, phenolic, unsaturated polyester and epoxy thermosetting resins and in urethane foam and coating formulations (Planet Chemicals, 2006).

Turbidity – Measure of the relative clarity of a given water. Turbidity has no health effects. However, high levels of turbidity can interfere with disinfection and provide a medium for microbial growth. Turbidity may indicate the presence of disease-causing organisms. These organisms include bacteria, viruses, and parasites that can cause symptoms such as nausea, cramps, diarrhea and associated headaches.

Ultrafiltration – a low pressure membrane process which can separate bacteria, some proteins, some dyes and other constituent which a molecular weight larger than 10,000 Daltons. The process removes contaminates by sieving or size exclusion.

1, 4 dioxane A chemical contaminant primarily used as an industrial stabilizer to enhance performance of solvents in manufacturing processes. Commonly used in food and food additives or in personal care products such as cosmetics, deodorants, soaps and shampoos. Currently there is not a federal or state MCL; however, the CDHS has established a notification level of 3 ppb.

1. EXECUTIVE SUMMARY

Water reclamation plants convert municipal wastewater to recycled water suitable for landscape irrigation and industrial uses. The City of San Diego (City) has two water reclamation plants, the North City Water Reclamation Plant (NCWRP) and the South Bay Water Reclamation Plant (SBWRP) with the capacity to produce 24 million gallons per day (mgd) and 13.5 mgd of recycled water respectively. Currently, the City's Water Department sells an annual average of 6 mgd of recycled water.

In January 2004, the City began the Water Reuse Study, which included an evaluation of all options for the use of recycled water to meet current and future water supply and reuse needs. Some recycled water use options outlined in City Council Resolution No. R-298781, such as reservoir augmentation and supplementing aquifers used for drinking water supplies (indirect potable reuse), would require higher water quality than is currently produced by the NCWRP and SBWRP.

In July 2004, the City's Water Department and its consultant MWH embarked on an 18-month testing program to determine the effectiveness of a three-step Advanced Water Treatment (AWT) process to produce water suitable for indirect potable reuse from tertiary water produced at the NCWRP. The AWT process consisted of three steps: ultrafiltration (UF); reverse osmosis (RO); and ultraviolet (UV) light + hydrogen peroxide. A simple flow diagram of the AWT process is provided below.

Advanced Water Treatment Process

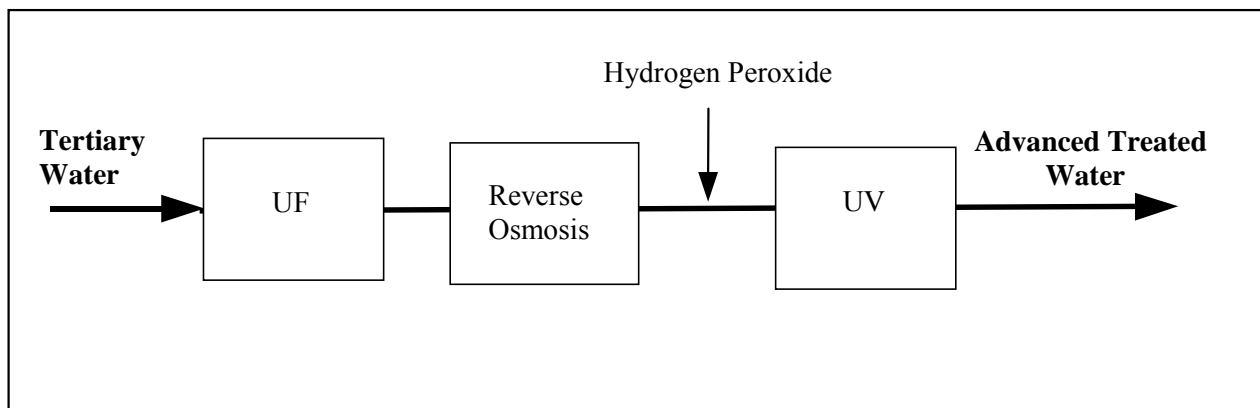

The major objectives of this testing program were:

- Assess the water quality performance of the AWT process during operation on tertiary water (recycled water before disinfection) from the NCWRP;
- Compare AWT product water quality to San Diego's existing source water supply;
- Determine the impact of advanced oxidation (UV + hydrogen peroxide) on select endocrine disrupting compounds (EDC) and pharmaceuticals and personal care products (PPCP);
- Evaluate methods to monitor the removal reliability (integrity) of new generation RO membranes designed for water reuse.

In order to assess the performance of AWT, an extensive water quality sampling plan was initiated during this study. Accordingly, on multiple occasions throughout the testing period, samples were collected from the water entering and exiting each step of the AWT process. Samples were analyzed by several certified laboratories for a full spectrum of contaminants including:

1. Contaminants regulated under federal and State of California drinking water standards;
2. Twenty one (21) contaminants of concern (those under consideration for potential future drinking water regulation) and,
3. Twenty-nine (29) EDC and PPCP selected based on the likelihood of their occurrence in wastewater and wide variety of physical/chemical characteristics.

To understand the significance of water quality data, it is important to compare the data to drinking water standards established by the United States Environmental Protection Agency (USEPA) and the California Department of Health Services (CDHS). The Maximum Contaminant Level (MCL) is the highest concentration of a contaminant that is allowed in drinking water.

Primary MCLs are standards set as close to the Public Health Goal (PHG) as economically or technically feasible. The PHG is the concentration of a contaminant in drinking water below which there is no known or expected risk to health. Secondary MCLs are standards set to protect odor, taste and appearance of drinking water.

Notification levels are health-based advisory levels established by CDHS for contaminants in drinking water that lack MCLs. Notification levels are advisory levels to drinking water regulators, not enforceable standards. For more information on state and federal water quality standards visit www.dhs.ca.gov/ps/ddwem/chemicals/chemindex.htm and www.epa.gov/safewater/standards.html.

Since twenty eight (28) of the twenty nine (29) selected EDC/PPCP measured during this study do not currently have a MCL or notification level, the collected data was compared to the method detection limits (MDL) of the given compounds. The MDL represents the smallest concentration that can be detected by the analytical method used to measure a given compound. The method used to measure the 29 selected EDC/PPCP compounds during this study has the lowest MDLs currently available to modern science.

Results from this study showed the AWT process produced water with the following characteristics:

1. all regulated compounds were below their MCLs,
2. 21 contaminants of concern were below their notification levels, and

3. all 29 targeted EDC/PPCP were below their MDLs.

In addition, the RO and UV + hydrogen peroxide contaminant removal efficiencies observed during this study are similar to those observed in other water industry studies (Reference: Appendix C, Southern Nevada Water Authority Research Laboratory Report).

The water quality data collected from the AWT research facility was compared to water quality data from grab samples taken from two City of San Diego reservoirs, which supply source water to drinking water filtration plants. The data showed that AWT product water was lower or equivalent in concentration for nearly all contaminants/parameters measured. Five (5) contaminants (total trihalomethanes, chloroform, nitrate, N-nitrosodimethylamine (NDMA) and 1,4 Dioxane) were measured in slightly higher concentrations in the AWT product than the reservoir samples, yet their concentrations were below regulatory concern (see Section 4.2.2).

Like the AWT product water, the reservoir water's regulated compound concentrations were all below MCLs, and contaminants of concern were all below notification levels. However, unlike the AWT product water, reservoir water did have detectable trace concentrations of seven (7) of the twenty-nine (29) selected EDC/PPCP. These EDC/PPCP concentrations are similar to levels found in many drinking water supply sources across the United States (Reference: Appendix C, Southern Nevada Water Authority Research Laboratory Report).

Additional comparisons of AWT product water quality were also made outside of the scope of this research study by City of San Diego technical staff involved in the Water Reuse Study. This included comparing AWT product water quality data generated at the research facility to historical water quality data from the City's drinking water sources including: Colorado River Water, State Project Water and five local reservoirs, which store imported water. Details and results of this comparison are provided in Appendix D.

Because reverse osmosis (RO), the second step in the AWT process, removed most of the EDC/PPCP to below detection, a special experiment was conducted to assess the ability of the

third step in the AWT process, UV + hydrogen peroxide, to remove EDC/PPCP. Accordingly, eight (8) EDC/PPCP, selected for their wide variety of chemical and physical characteristics and ability to be readily obtained, were added (spiked) into the RO product water. As in all AWT testing, the UV reactor was set at a lamp power and flow setting to achieve 90% removal of the disinfection byproduct, N-nitrosodimethylamine (NDMA). This is the same level of NDMA removal that the Orange County Water District will be targeting in their Groundwater Replenishment System, an indirect potable reuse project.

Results from these experiments demonstrated that UV with 5-mg/L hydrogen peroxide removed more than 99% of seven (7) of the spiked EDC/PPCP compounds. The remaining compound, a fire retardant/plasticizer: Tris (2-chloroethyl) phosphate (TCEP), was removed at only 36% through the UV + hydrogen peroxide step. However, results from the water quality analysis conducted on the complete AWT process during this study showed that RO removed TCEP, present in NCWRP tertiary water, to levels below the MDL.

It is important that an AWT process not only removes contaminants to levels below concentrations of significance, but that it also operates reliably over time. There are various methods used in the water treatment industry to monitor the ability of RO membranes systems to remove contaminants. During this testing program, seven (7) different RO integrity-monitoring methods were evaluated under various operating conditions.

The MS2 phage challenge test was the standard against which the other monitoring methods (vacuum decay testing, on-line sulfate monitoring, on-line conductivity monitoring, conductivity probing, dye challenge testing and TRASAR[®] challenge testing) were compared. The MS2 phage is a virus that is not pathogenic to humans and is similar in size and shape to the polio and hepatitis viruses. Challenge testing with MS2 phage consisted of adding a known quantity of MS2 phage into the water entering the RO system, measuring the concentration of MS2 in the product water and calculating percent removal. Data from this study showed the four “new generation” RO membranes tested achieved from 99.00% to 99.99% (i.e. 2-4 log) removal of MS2 phage. Results from this study also showed that many of the integrity monitoring methods tested correlated to MS2 phage removal.

Major findings from the Advanced Water Treatment Research Studies are listed below:

1. AWT product water had the following characteristics: all regulated parameters were below MCLs established by federal and state drinking water standards; 21 contaminants of concern were below their notification levels and 29 target EDC/PPCP commonly found in reclaimed water were below their MDLs.
2. AWT product water was lower or equivalent in concentration for nearly all contaminants /parameters measured when compared to samples from San Diego reservoirs which store untreated imported water.
3. The UV dose for 90% NDMA destruction with 5-ppm hydrogen peroxide achieved more than 99% removal of all spiked EDC/PPCP with the exception of TCEP, which experienced 36% removal. However, RO is shown to effectively remove TCEP.
4. The four “new generation” RO membranes tested achieved from 99.00% to 99.99% (2-4 log) removal of MS2 phage.
5. A variety of integrity monitoring methods are available to assure consistently high quality water from the RO component of a full-scale AWT system.
6. The AWT equipment contaminant removal rates observed in this study were consistent with previous equipment performance studies.

2. INTRODUCTION

2.1. Water Repurification Project

In 1993, the City of San Diego (City) and the San Diego County Water Authority (Water Authority) initiated a Water Repurification Feasibility Project to supplement local water supplies. MWH (formerly Montgomery Watson) implemented the study, in which a conceptual project was proposed for regulatory review. In the feasibility report, it was proposed that after undergoing further treatment, reclaimed water from the City's North City Water Reclamation Plant (NCWRP) could be stored at the San Vicente Reservoir and subsequently used for potable water supply. The proposed treatment train consisted of the following unit processes: microfiltration (MF) or ultrafiltration (UF), reverse osmosis (RO), ion exchange, ozonation and chlorination. In 1994, the final project report was submitted to the California Department of Health Services (CDHS). After reviewing the proposed project plan, the CDHS granted the Water Authority conditional approval to move forward with the Water Repurification Project.

In order to address initial comments raised by the CDHS in their conditional approval, the City embarked on a pilot testing program in 1995. During the preliminary portion of the testing, the membrane processes of the treatment train were operated at the pilot scale to determine their ability to reject microorganisms such as *Giardia*, *Cryptosporidium* and *MS2 Phage*. The results of the preliminary pilot testing were submitted for review by CDHS, and based on their review additional specific concerns were identified to be resolved in order to provide final approval for the project. Thus, in 1996 further pilot testing was performed to address CDHS concerns and to assure successful design and performance of the proposed 23 MGD AWT plant that was scheduled for completion near the NCWRP by the end of year 2000. Simultaneously, the City of San Diego and California Water Resource Control Board (SWRCB) initiated a health effects study, which was conducted by the Western Consortium for Public Health (Total Resource Recovery Project, 1996). Upon reviewing data from the pilot study and the microbial risk study, the CDHS affirmed that the proposed treatment train could produce a safe, high quality drinking water supply that met all state and federal standards. Based on these findings, the project

received final approval from the CDHS in 1998. However in early 1999, the City of San Diego Council, decided to cancel the project due to public perception issues.

2.2. Developments in Indirect Potable Reuse

Since completion of the Water Repurification Feasibility Project described above, there have been several developments in the area of water reclamation for indirect potable reuse applications including:

- Implementation of several full-scale water reclamation facilities used for indirect potable applications including (*Water Factory 21-Orange County , CA; West Basin Water Recycling Plant-El Segundo, CA; Clean Water Revival Project-Dublin CA; Terminal Island, Los Angeles , CA* and international (*NEWwater Reclamation Plants- Singapore and Sulaihiya Reclamation Plant- Kuwait*);
- Increasing concern for emerging contaminants of concern present in reclaimed water, including endocrine disrupting compounds (EDCs) and pharmaceutical and personal care products (PPCPs);
- Recognition of ultraviolet (UV) irradiation + hydrogen peroxide (or other oxidant) as the best available technology (BAT) for NDMA destruction and demonstration of advanced oxidation as an effective method to destroy other organic compounds typically present in reclaimed water;
- Advancements in UV technology making it more economical than ozone for disinfection without forming disinfection by-products;
- Introduction of new generation RO membranes being offered for water reuse which have not been evaluated for reliability and long term performance.

2.3. Water Reuse Study 2005

In 2004, the City of San Diego began revising their Water Reuse Master Plan to include an evaluation of all options for the use of recycled water produced by their two reclaimed water plants. The current reclamation facilities owned by the City include the North City Water Reclamation Plant (NCWRP) and South Bay Water Reclamation Plant (SBWRP). The overall study, named the Water Reuse Study 2005, evaluated several reuse options, including those, which would require AWT.

The research studies discussed in this report were performed to obtain information on an AWT train during operation on tertiary water from the NCWRP. A schematic of the pilot train tested during the current study is provided in **Figure 1**. This treatment train is similar to AWT trains implemented for full-scale indirect potable reuse projects such as Water Factory 21 (Orange County, CA) and NEWater project plants in Singapore. San Diego's current AWT research has cost \$739,110 in contractual services, equipment and supplies. \$489,000 of these costs are being reimbursed through grants from the California Department of Water Resources (CDWR) and San Diego County Water Authority.

2.4. Project Objectives

The overall intent of the Advanced Water Treatment (AWT) research studies was to build upon knowledge gained from previous testing conducted by the City and other agencies which have implemented, or are planning, an indirect potable reuse project. Accordingly, the program was designed to meet the following specific objectives:

- Review the current state of knowledge of issues related to potable reuse including: RO integrity monitoring, differences among RO products available for water reuse, RO operating parameters and implementation of UV + Peroxide for advanced oxidation;

- Evaluate the performance of an AWT consisting of UF→ RO →UV + Peroxide during operation on tertiary treated wastewater from the NCWRP;
- Assess the effectiveness of new generation RO membranes currently offered for water reuse;
- Perform field evaluation of several direct and indirect RO integrity monitoring methods;
- Determine the impact of UV/Peroxide on selected EDCs and PPCPs.

3. MATERIALS AND METHODS

3.1. AWT Pilot Treatment Trains

A schematic of the overall pilot plant layout used during the study is provided in **Figure 2**. As shown, two distinct treatment trains were evaluated. Train #1 consisted of a UF membrane system (provided by GE/Ionics) followed by two RO skids each containing two independent systems. As shown, each RO system consisted of two pressure vessels arranged in series each housing (3) 4" X 40" membrane elements. The skids were configured to contain two identical independent systems, which allowed RO membranes from two different suppliers to be simultaneously evaluated on each skid. The primary purpose of Train #1 was to evaluate the integrity of new generation RO membranes currently being offered for water reuse applications. Participating suppliers were Koch Membrane Systems, Hydranautics, Saehan Industries and Toray.

Train #2 contained the major unit process components of the proposed AWT treatment train including a UF membrane system (leased from Zenon Environmental), dual-stage RO system (containing 18, 4" by 40" membranes) and a low pressure high output (LPHO) UV system (leased from Trojan Technologies). Train #2 was operated to evaluate the operational and water quality performance of the AWT during operation on reclaimed water from the NCWRP. Additional testing was also performed on the UV system to assess the impact of a 1-Log NDMA removal dose on a select group of EDCs and PPCPs. Though not shown in **Figure 2**, during the last several months of pilot testing the Zenon UF system (Train #2) was replaced with the UF system provided by GE/Ionics.

3.2. Experimental Plans

The project objectives were met by devising specific experimental plans for each of the following categories: RO integrity monitoring, AWT evaluation and UV spiking. A description of each plan is provided below.

3.2.1. RO Integrity Monitoring (Train #1)

The integrity of the four RO membranes tested was assessed using various direct and indirect monitoring techniques. Prior to beginning pilot testing, a literature review was conducted to identify and become familiar with the various methods currently used to monitor integrity of RO membranes and RO membrane systems. Based on this review a list of various monitoring techniques along with their specific purpose was generated as provided in **Table 1**. The basic test plan implemented to evaluate these various techniques is provided in **Figure 3**. As shown, field evaluations were conducted in three phases. The purpose of Phase I testing was to evaluate various methods and integrity of RO membranes from 4 different suppliers during operation at 50% recovery. Phase II testing was intended to evaluate the impact of staging on the various RO integrity methods by operating the membrane which demonstrated the highest integrity and salt rejection characteristics in a two stage system. Lastly during Phase III, the ability of select methods to detect breaches incurred on the RO membrane system was evaluated.

The specific methods used to implement each of the integrity monitoring techniques (except soluble dye and TRASAR® challenge testing) evaluated during this study are described in detail elsewhere (Trussell et al., 1997). Soluble dye testing was conducted in accordance to ASTM D3923 and ASTM D6908. The specific dye selected for this study was FD&C Red Rye #40. This dye is commonly used in commercial food and drug products and is well rejected (>99%) by intact RO membranes with no adverse impact on performance (USBR 2000). Prior to testing, a calibration curve was developed relating UV absorbance at the 530-nm wavelength to dye concentrations ranging from 1 µg/L to 1 mg/L. The dye was dosed continuously over a 10 minute period to the feed of the RO systems to achieve a concentration of approximately 190

mg/L. A similar approach was used during challenge testing with TRASAR; however, permeate concentrations were then determined using the Trace Leak Detection (TLD) system provided Nalco Inc.

3.2.2. AWT Performance Evaluation (Train #2)

The primary objective of the overall study was to assess the ability of the AWT system to remove key contaminants present in the NCWRP tertiary effluent. This was accomplished by implementing a comprehensive water quality monitoring program on the major unit processes of the pilot scale AWT. As identified in **Figure 2**, sampling locations, designated by S#, were selected throughout the train to assess removal abilities of each unit process. Specific sampling locations include tertiary effluent (UF Feed), RO Feed (UF permeate), RO Permeate (UV Feed) and UV + peroxide product water. Sampling events were performed several times during the course of the project under set operating conditions.

The specific operating conditions for each unit process in the AWT are presented in **Table 2**. The operating conditions of the membrane processes were selected based on findings from past membrane studies conducted by the project team and recent testing performed at Orange County and West Basin, California and Scottsdale, Arizona. The specific RO membrane tested in Train #2 was selected by performing bench scale testing on each of the four membranes evaluated in Train #1. Lastly, the operating conditions of the UV pilot were determined by seeding RO permeate water with NDMA and determining the flow and power set points which resulted in a 1-Log destruction of NDMA (see **Section 3.2.3**).

A wide variety of inorganic and organic compounds were measured in the feed and effluent of each unit process in the AWT. In general inorganic compounds included metals, anions, cations, hardness, silica and other physical parameters such as color, odor and turbidity. The specific organic compounds included a wide range of herbicides, pesticides, semi-volatile and volatile analytes. The majority of the organic compounds were selected based on the State of California Drinking Water Standards. As provided in **Table 3**, a target list of twenty-nine (29) EDC and PPCP were also measured in the influent and effluent of each unit process. The list contains

compounds commonly found in secondary wastewater such as caffeine and ibuprofen along with compounds identified in literature as being commonly found in the environment (Kolpin 2002). In addition, these compounds are characterized by a wide variety of physical/chemical properties. Though many of the selected EDC/PPCP compounds are not currently regulated, a number of them do appear in the CDHS Groundwater Recharge Reuse Draft regulations dated December 2004: <http://www.dhs.ca.gov/ps/ddwem/publications/waterrecycling/index.htm>.

In addition to water quality performance, the operational performance of the membrane components of the AWT (i.e. UF and RO) was also assessed during the course of the study. This was accomplished by monitoring the rate of increase in transmembrane pressure (UF) and net operating pressure (RO) during operation at constant flux rates. In addition, the impact of feedwater temperature on the net driving pressure was accounted for by monitoring the temperature corrected specific flux rate (i.e. flux per unit pressure) with respect to operating time. Specific methods for calculating these parameters can be found elsewhere (Adham & DeCarolis 2004).

3.2.3. UV Spiking Study (Train #2)

The effect of UV on the destruction of EDCs and PPCPs at an operational dose to achieve 1 log NDMA destruction was assessed at the pilot scale by conducting a series of spiking experiments. This was accomplished by first spiking NDMA into the RO permeate upstream of the UV process in order to determine the flow and lamp power settings necessary to achieve 1 Log removal of NDMA. At the same time, samples were collected and analyzed using a collimated beam (CB) apparatus. Data from the CB experiment were then used to establish a dose response curve and determine the applied dose required to achieve a 1 Log destruction of NDMA for this water source.

During the second experiment, a cocktail solution containing eight (8) EDCs/PPCPs, selected from the target list described above, along with NDMA was spiked upstream of the UV reactor during operation at the lamp power and flow settings established from the first seeding experiment. Spiking was required due to the trace level of these compounds in the RO permeate.

In addition, inputting known concentrations of these select compounds allowed the efficacy of the UV + peroxide process to be readily determined. The eight (8) compounds, shown in **Table 4**, were selected because they represent a wide variety of chemical structures. All compounds were spiked at a nominal dose of 500 ng/L. This dose was based on previous removals seen during studies conducted by SNWA at Trojan Technology Facilities as described in **Appendix C**.

It should be noted during this experiment a 5 mg/L dose of hydrogen peroxide was also added upstream of the UV process. It is well known that peroxide followed by UV creates hydroxyl free radicals, which act as extremely strong oxidizers. With respect to NDMA, the addition of peroxide allows for free radicals to directly react with photolysis cleavage products and prevent them from reforming NDMA.

3.3. Laboratory Resources

In order to provide redundancy in water quality analysis and achieve measurements to low detection levels, three laboratories were employed during the project. The specific facilities utilized were the City of San Diego Water Quality Laboratory (City Lab), MWH Commercial Laboratory and Southern Nevada Water Authority (SNWA) Research Laboratory. The City and MWH labs performed analysis of all compounds regulated under California and federal drinking water standards (**Tables 8, 9, 10**). Both laboratories were used to conduct these analyses to ensure redundancy. In addition, MWH lab performed analysis on emerging contaminants of concern including NDMA, 1,4 dioxane, and perchlorate. Though not currently regulated under state or federal drinking water standards, CDHS has set notification levels (ppb) for these compounds at 10,6 and 3, respectively. The SNWA laboratory performed all EDC and PPCP analyses under the direction of Dr. Shane Snyder. The SNWA laboratory is equipped with state of the art equipment for detecting emerging contaminants including LC/MS/MS (liquid chromatograph/mass spectrometer) and GC/MS/MS (gas chromatograph). Dr. Snyder has performed analysis for several key projects requiring measurements of emerging contaminants in the US and is recognized worldwide as an expert in this field.

4. RESULTS AND DISCUSSION

4.1. RO Integrity Monitoring (Train #1)

4.1.1. Phase I Results

Field evaluations of various RO integrity monitoring techniques including vacuum decay testing, conductivity probing, dye challenge testing, on-line conductivity and sulfate monitoring were conducted during Phase I testing. In general it was found that vacuum decay testing was a good screening tool to assess the integrity of the delivered RO products. In addition, on-line sulfate monitoring was easily implemented and provided a sensitivity of approximately 3 log removal (LRV). Lastly, a direct correlation was observed between all methods tested and MS2 bacteria phage rejection. Results of select monitoring techniques implemented during Phase I are provided below.

- *Vacuum Testing*

Each individual RO membrane tested during Phase I was vacuum tested prior to installation. Vacuum testing was conducted by first evacuating the membranes to 28.5 inch Hg. Next, each individual membrane was isolated from the vacuum source and vacuum decay was measured over a 5-minute period. Vacuum decay results measured for membranes supplied from the four participating membrane suppliers (RO 1, RO 2, RO 3, RO 4) are provided in **Figure 4**. The average values shown for each supplier are based on decay rates measured during the first minute of the test from 6 individual membranes. As shown, the vacuum decay varied among the membranes tested ranging from 0.16-6.6 inch Hg/min. As indicated, all membranes (RO 3 the exception), were well below the acceptable decay rate 6.0 in Hg/min, provided in ASTM D3923-94 (ASTM 2003).

- *Sulfate Monitoring*

Sulfate samples were collected hourly in the feed and permeate of each RO system over a 24-hr period to provide an on-line measurement of RO integrity. A plot showing log removal values (LRV) of sulfate measured over 24 hour period for each RO membrane is provided in **Figure 5**. As shown, sulfate rejection of each membrane remained consistent over the 24-hr period and the achievable sulfate LRV ranged from 2.4-3.1 for the four membranes tested.

- *MS2 Challenge Experiments*

Challenge experiments were conducted on all RO membrane systems using MS2 bacteria phage. Results of the MS2 seeding experiments are presented in **Figure 6**. As indicated, the LRV values shown for each membrane represent the average values based on 6 samples of RO feed and 6 samples RO permeate. Results indicate that RO membranes 1, 2, and 4 achieved $LRV > 4$, while the RO 3 only achieved LRV of 2-2.5. These results correlate well with both vacuum decay and sulfate monitoring data presented above.

4.1.2. Phase II Results

The impact of staging on select integrity monitoring methods was evaluated during Phase II by conducting additional experiments on the best performing membrane (RO 4) from Phase I testing. As shown in **Figure 7**, MS2 rejection achieved by the two-stage RO system was similar to that achieved by the single stage RO system. However, as presented in **Figure 8**, sulfate rejection of the two-stage system was noticeable lower (0.5 LRV on average) than that achieved by the single stage system. The observed loss of sensitivity with regards to sulfate removal in the two-stage system, as opposed to the consistent rejection of MS2, can be attributed to differences in the removal mechanisms of these two constituents. For instance, dissolved species such as sulfate are dominantly removed by diffusion while particulate matter (such as MS2) is removed by size exclusion. Therefore in an intact RO system it would be expected that the overall LRV of dissolved species be lower because of increased feed concentrations resulting from staging.

As part of Phase II testing, challenge experiments were also conducted using the TLD system described in Section 3.2.1. As presented in **Figure 9**, the TRASAR chemical was rejected with sensitivity greater than 6 log. These results are promising and suggest the TLD system may have potential as a means of RO integrity monitoring. However, due to its early on application for such purposes further testing would be required.

4.1.3. Phase III Results

The purpose of Phase III testing was to evaluate the sensitivity of select integrity monitoring techniques to compromises introduced in the two stage RO system evaluated during Phase II.

Two types of integrity breaches were introduced to the RO system as part of Phase III. First a small section of both o-rings located on the middle element of stage 1 were removed. Secondly, one element in Stage 2 was replaced with a chlorine damaged element acquired from another pilot system being evaluated by the project team at the time of this study. Upon installing the damaged membrane element and o-rings several integrity monitoring test were performed on the system including conductivity probing; on-line conductivity and sulfate monitoring; and challenge experiments with TRASAR and MS2. Integrity monitoring of the breached system showed that it achieved only slightly lower log removal of conductivity (1.7 vs 2.2) and sulfate (2.3 vs 3.1) than achieved by the intact system. In addition, only slightly higher levels of conductivity and sulfate were measured in permeate of Stage 1 as compared to Stage 2. However, MS2 phage was removal was shown to be significantly impacted by the imposed breaches. Overall the breached system only achieved 2.2 LRV of MS2 as compared to 4 LRV achieved by the intact system.

4.2. AWT Performance Evaluation (Train #2)

4.2.1. Water Quality Data

To understand the significance of water quality data, it is important to compare the data to standards established by the Environmental Protection Agency (USEPA) and the California Department of Health Services (CDHS). The Maximum Contaminant Level (MCL) is the highest concentration of a contaminant allowed in drinking water. Primary MCLs are standards

set as close to the Public Health Goal (PHG) as economically or technically feasible. The PHG is the concentration of a contaminant in drinking water below which there is no known or expected risk to health. Secondary MCLs are standards set to protect odor, taste and appearance of drinking water. Notification levels are health-based advisory levels established by CDHS for chemicals in drinking water that lack MCLs. Notification levels are advisory levels not enforceable standards. Since all but one of the 29 selected EDC/PPCP measured during this study do not currently have a MCL or notification level, the collected data was compared to the method detection limits (MDL) of the given compounds. The MDL represents the smallest concentration that can be detected by the analytical method used to measure a given compound. The peer reviewed published methods used to measure the 29 selected EDC/PPCP compounds during this study have the lowest MDLs currently available to modern science.

Tables 5, 6 and 7 present water quality data from samples collected at various locations in the AWT pilot train between 3/23/05-12/30/05 analyzed by the City of San Diego Water Quality Laboratory, MWH Commercial Laboratory and the SNWA research Laboratory, respectively. As shown, each table identifies key information for each parameter measured including the sample date, method detection limit (MDL), analytical method and values measured from samples taken at different sampling locations in the AWT pilot train. In general, the AWT effectively removed inorganic and organic compounds to levels near or below detection limit. In addition, all parameters measured in the RO permeate and UV+ peroxide product water were below the maximum contaminant levels (MCL) established by federal and California State primary and secondary drinking water standards. These standards have been provided for reference in **Tables 8-10**. In addition, 21 contaminants of concern measured in the RO permeate and UV peroxide effluent including NDMA, 1,4 dioxane and perchlorate were all below current notification levels established by CDHS as presented in **Table 11**. Additional information regarding the specific analysis and water quality results for each laboratory is provided **Appendices A, B, and C**.

Results of the EDC/PPCPs analysis, presented in **Table 7**, show that the AWT removed all 29 compounds present in the North City tertiary effluent to levels below the method detection limits. One exception was triclosan, which appeared in all sampling locations including blanks

on 3/25/2005 and 4/13/2005. As explained by Dr. Shane Snyder in a technical memo (**Appendix C**), this contamination was found in all samples processed at SNWA during this time period. It is speculated that the samples were contaminated from stock chemicals used in the analysis. To further address this issue, all stock chemicals were replaced and a final sampling was repeated on 12/30/2005 using new, unwashed bottles. As shown in **Table 7**, triclosan was below detection in UV+ peroxide effluent.

4.2.2. AWT Product Water Quality Comparison

Comparison #1

For comparison purposes, during the April 13th 2005 pilot sampling event (described in Section 4.2.1) samples were also collected from two lakes located in San Diego, which provide source water to drinking water facilities. These source waters are Lake Murray and Lake Miramar which supply water to the Alvarado Treatment Plant and Miramar Treatment Plant, respectively. Results from MWH laboratory (**Table 6**), show that all samples of AWT product water (i.e. UV + peroxide effluent) analyzed during this study were near or lower in concentration for all parameters analyzed in grab samples taken from Lake Murray and Lake Miramar. Of the 174 parameters analyzed by MWH lab, five were slightly higher in concentration in the AWT product as opposed to that measured in one or both lake samples. These five parameters were total trihalomethanes (TTHMs), chloroform, nitrate, NDMA, and 1,4 Dioxane. Further information regarding each of these compounds, along with discussion on the significance of the low-level occurrence of the compounds in AWT product water is provided below:

Total Trihalomethanes (TTHM)- Represent a group of compounds (**chloroform**, bromodichloromethane, dibromochloromethane, and bromoform) which are byproducts of the chlorination process used for disinfection during drinking water treatment. TTHM are formed by the reaction of chlorine with organic and inorganic matter present in drinking water sources. Though not completely understood the potential health impacts related to the presence of TTHM in drinking water include cancer and reproductive and developmental effects. (USEPA 2006). Because drinking water disinfection creates TTHM, they are commonly found in potable drinking water. For instance, data from San Diego's potable water supply (produced by

Alvarado and Miramar treatment plants) in 2004 showed the highest distribution system running average of TTHMs was 61.5 ppb (City of San Diego 2004). This is relatively high compared to that measured in the AWT product water (3 ppb) during this study; however, both sources were below federal MCL of 80 ppb.

- **Nitrate** - Nitrate (NO_3) is a naturally occurring form of nitrogen (N), which is essential for plant growth and is often added to soil to improve productivity. Nitrate can enter drinking water supplies through surface water runoff or by traveling through soil into groundwater supplies after rainfall or irrigation events. Sources of nitrate from wastewater include urea, ammonia cleaners, food solids and bacterial cells. Nitrate is generally not toxic to adults or children over the age of two or three years, however, infants under six months of age are susceptible to nitrate poisoning (<http://www.uaf.edu/fs/water/contaminants/nitrate.htm>). As a result, nitrate is regulated in drinking water under both federal and state standards. When laboratories analyze nitrate in water samples results are reported as either nitrogen (Nitrate-N) or nitrate (NO_3). The MCL set for nitrate by federal drinking water regulations is 10 mg/L Nitrate-N, while the California Department of Health Services sets the limit of nitrate in drinking water at 45 mg/L Nitrate $-\text{NO}_3$. Though the AWT process was effective at removing nitrate, nitrate was detected at low levels in the AWT product water. The highest level detected in AWT product was only 1.6 mg/L Nitrate-N or one sixth (1/6) the concentration allowed in drinking water.
- **NDMA** - *N*-Nitrosodimethylamine is a semi-volatile, yellow, oily liquid of low viscosity that has been extensively used in industry for several decades (USEPA, 2001). Some of the main applications of NDMA include the production of rocket fuel and use as an industrial solvent, rubber plasticizer, antioxidant and additive for lubricants. NDMA is also present in tobacco and a variety of foods, such as cheese, soybean oil, cured meats, and alcoholic beverages such as beer (Najm and Trussell, 1998). However, NDMA is suspected to have adverse health effects and the compound's extremely high toxicity has been known for more than 30 years. The U.S. Environmental Protection Agency (USEPA) has included NDMA in the list of "probable human carcinogens". However, there is no specific federal MCL for NDMA in drinking water. In 1998, after the discovery of NDMA in concentrations up to 3,000 ng/L at a rocket testing facility in the San Gabriel Valley, the State of California rushed the approval

of stronger NDMA regulations. The currently notification level of NDMA established by CDHS is 10 ng/L. Data from the AWT pilot study showed NDMA was well removed by the AWT process and was only detected in one AWT product sample at a concentration of 2.3 ng/l.

- **1,4 Dioxane** - Is a chemical compound primarily used as an industrial stabilizer to enhance performance of solvents in various manufacturing processes. It is also commonly used in food and food additives or in personal care products such as cosmetics, deodorants, soaps and shampoos. Currently there is not a federal or state MCL; however, the California Department of Health Services has established a notification level of 3 µg/L due to occurrence of the compound in some drinking water supplies. During this study 1,4 dioxane was detected in one of the samples collected from the AWT product at concentration of 2.8 µg/L, which is below the current notification level.

As shown in **Table 7**, EDC/PPCP samples analyzed from Lake Murray and Miramar Lake were near or below the detection limit for all compounds analyzed. Though at low levels, (i.e. < 10 ppt) five compounds were detected in the Lake Murray sample and six compounds were detected in Miramar Lake. Similar levels of these compounds along with others were detected in various U.S. drinking water sources in a survey recently conducted by Dr. Shane Snyder (Table 7, Appendix C). In comparison, all EDC/PPCPs measured from the AWT pilot were below the detection limit.

Comparison #2

Additional comparisons of AWT product water quality were also made outside of the scope of this research project by City of San Diego technical staff involved in the Water Reuse Study. This included comparing AWT product water quality data generated at the research facility to historical water quality data from the City's drinking water sources including: Colorado River, State Project Water and five local reservoirs, which store imported water. A technical memorandum along with tabulated water quality data detailing this comparison is provided in **Appendix D**. As noted, results of Comparison #1 and #2 differed due to the data used, averaging methods and reporting limits.

4.2.3. Reverse Osmosis Operational Performance Data

The operational performance of the RO portion of the AWT pilot train was evaluated by operating the system continuously over a target period of 5,000 hours. During the first 1,200 hours of operation, the system was operated under a range of feed water recoveries (75%-85%). The purpose of this operation was to determine the upper recovery limit the membranes could successfully operate without causing precipitation of limiting salts present in the NCWRP tertiary effluent. In addition, because the rejection capabilities RO systems decrease as recovery increases, water quality sampling was conducted during this period at 85% recovery. Based on performance and design of current full-scale AWT facilities a recovery of 85% represents the highest recovery an RO system built at NCWRP would be designed to operate.

During the initial operating period, the RO membranes exhibited fouling, as determined by increase in net operating pressure, while operating at 85% recovery. However, data collected during this period was limited because of an upset in the NCWRP, which resulted in interrupted feed flow to the AWT pilot system. Shortly after, high levels of free chlorine were detected in the RO feed and the conductivity rejection of membranes decreased sharply (i.e. 95% to 88%). Such data indicates the membranes were irreversibly damaged from exposure to chlorine. As a result, it was necessary to replace the membranes. This occurrence was due to the location of the intake of the pilot feed water pump in the NCWRP treatment train and would not be possible during full-scale AWT application. After this event, the project team installed an on-line free chlorine analyzer upstream of the pilot system to shutoff the pilot feed pump should chlorine be detected.

After installing the new membranes, the RO pilot was restarted at target flux of 12 gfd and recovery of 85%. As shown in **Figure 10**, during the ensuing 718 hours of operation the membranes fouled, as indicated by sharp decrease in specific flux (i.e. 0.20 to 0.13 gfd/psi). This data confirmed previous results described above which suggested operation at 85% recovery caused precipitation of salts on the membrane surface. In order to assess the long-term

operational performance of the RO membranes, the membranes were cleaned and restarted under conservative recovery conditions of 75%. This operation allowed the project team to evaluate membrane fouling caused by presence of biological and or organic matter present in the RO feed. Typically this type of fouling is much slower than that associated with salt precipitation. As shown in **Figure 10**, the system operated for 1,250 hours under these conditions with no observed membrane fouling as indicated by a decrease in specific flux.

4.3. UV Spiking Study (Train #2)

NDMA was spiked downstream of the RO process to determine the UV pilot settings (flow and power) required to achieve 1-log destruction of NDMA. Results from this experiment showed the electrical energy order (EEO) of the pilot system to be approximately 0.17 kWh/1000 gal/order. During the pilot testing experiment samples were also collected for analysis using a collimated beam (CB) apparatus. The dose response curve generated from CB testing is provided in **Figure 11**. From this plot the applied dose required to achieve 1-LRV of NDMA for the given feed water was 1,104 mJ/cm². These results agree with other studies (Sharpless 2003a) which found that one log NDMA removal required UV dose of 1005 mJ/cm².

Following the establishment of operating conditions to achieve 1-log NDMA, an additional spiking experiment was conducted using the eight select EDC and PPCP compounds described in Section 3.2.3. This experiment included the addition of 5-mg/L hydrogen peroxide upstream of the UV process. Influent and effluent concentrations of the EDC and PPCP compounds measured during this experiment are shown in **Table 12**. These results show the UV peroxide process achieved more than 2-log destruction of most of the tested EDC and PPCP compounds with the exception of TCEP. Though TCEP was resistant to UV peroxide it was well removed by the RO process, as shown in **Table 7**.

The average EEO values of the spiked compounds including NDMA, EDC, and PPCP are displayed in **Figure 12**. All the EEO values of EDC and PPCP compounds except TCEP were lower than the NDMA EEO value (0.17).

5. SUMMARY AND CONCLUSIONS

The objectives of this study were met by operating pilot trains on tertiary water from the NCWRP over an 18-month period (July 2004 – December 2005). Train 1 consisting of UF followed by RO was used to assess the integrity of new generation RO products currently offered for water reuse. Train 2 consisting of UF/RO/UV peroxide was used to evaluate AWT performance and assess the ability of UV peroxide to remove select EDC/PPCP when applied at a dose required for 1 log NDMA removal. Major conclusions can be made from the results:

RO Integrity Monitoring

- A variety of integrity monitoring methods are available to ensure consistent RO system performance of a full scale AWT system;
- The four new generation RO membranes tested achieved between 99% to 99.99% (2-4 log) removal of MS2 phage;
- The TRASAR system offered by Nalco Inc. shows potential to provide on-line measurement of RO integrity with sensitivity greater than 6 log.

AWT Performance

- AWT reduced all compounds regulated by state and federal drinking water standards to below their MCLs contaminants of concern below their notification levels and all 29 selected EDC/PPCP below their MDLs;
- The AWT equipment contaminant removal rates observed in this study were consistent with previous equipment performance studies;
- Compared to samples from San Diego reservoirs which store untreated imported water, AWT product water was lower or equivalent in concentration for nearly all contaminants /parameters measured;
- RO system operated with no fouling for greater than 1200 hours with recovery of 75% and flux of 12 gfd.

UV Spiking Experiments

- The EEO values required for 90% (1-log) NDMA removal from NCWRP tertiary effluent after UF and RO treatment ranged from 0.16-0.17 Kwh/1000 gal/order;
- For 1 log NDMA destruction, the equivalent UV dose was 1104 mJ/cm²;
- The UV dose for 90% NDMA destruction with 5-ppm hydrogen peroxide achieved more than 99% removal of all spiked EDC/PPCP with the exception of TCEP which removal was 36%; however, water quality analyses conducted during this study showed RO removed TCEP below its MDL.

REFERENCES

City of San Diego Water Department “2004 Annual Drinking Water Quality Report”.

<http://www.sandiego.gov/water/quality/index.shtml>

Adham, S.S., DeCarolis J., (2004) *Application of Membrane Bioreactors Followed by Desalting Reverse Osmosis Membranes for the Treatment of Primary Wastewater for Water Reuse*, Submitted to the Desalination Research and Innovation Partnership.

ASTM, 2003, Standard Practice for Detecting Leaks in Reverse Osmosis Devices, Designation D3923- 94 (reapproved 2003)

Trussell R. R., Adham, S. S., Richardson G. T., Najm, N. I., Ross., D and Gramith, K., (1997) *Membrane Prequalification Pilot Study Final Draft Report* prepared by Montgomery Watson.

Total Resource Recovery Project; by Western Consortium for Public Health in association with EOA, Inc.; June 1996

Desalination Research and Innovation Partnership (DRIP) Project titled “ Reverse Osmosis Membrane Integrity” conducted at the NCWRP 10/05 – 11/05.

Desalination Research and Innovation Partnership (DRIP) Project titled “Long Term Testing of New Generation Reverse Osmosis Membranes and Determination of Removal Efficiency for Emerging Recycled Water Contaminants” conducted at the NCWRP 10/05 – 1/06.

<http://www.dhs.ca.gov/ps/ddwem/publications/waterrecycling/index.htm>

<http://www.dhs.ca.gov/ps/ddwem/publications/waterrecycling/index.htm>

Kolpin, D. W., Furlong, E. T., Meyer, M. T., Thurman, E. M, Zaugg, S. D., Barber, L. B., and Buxton, H. T., “Pharmaceuticals, Hormones, and Other Organic Wastewater Contaminants in U.S. Streams, 199-2000: A National Reconnaissance”, *Environmental Science and Technology*, 36(6), 1202-1211

Planet Chemicals, 2006, <http://www.planetchem.com/tcep.htm>

Sharpless, C. M., Linden, K. G., “Experimental and Model Comparisons of Low- and Medium-Pressure Hg Lamps for the Direct and H₂O₂ Assisted UV Photodegradation of *N*-Nitrosodimethylamine in Simulated Drinking Water”, *Environmental Science and Technology*, 37, 2003, 1933-1940

USEPA, 2006, Terms of Environment: Glossary, Abbreviations and Acronyms
<http://www.epa.gov/OCEPATERMS/pterm.html>

USEPA, 2001, “EPA Chemical Profile: Chemical Identity: Nitrosodimethylamine”
<http://yosemite.epa.gov/oswer/ceppoehs.nsf/Profiles/62-75-9>

USBR, 2000, Evaluation of Methods for Monitoring the Integrity of Reverse Osmosis Membrane Systems, USBR; Denver, CO; April 2000

Table 1: Identification of Various RO Integrity Monitoring Techniques

Monitoring Techniques	Purpose
Vacuum Hold Test	Test Integrity of Delivered RO Product Prior to Installation
Conductivity Probing	Test Integrity of RO System(s) Post Membrane Installation
On-Line Conductivity Monitoring Sulfate Monitoring	Provide Continuous Measurement of RO System Integrity
Challenge Experiments (Soluble Dye, TRASAR® ,MS2 Phage)	Periodic Measurement of RO System(s) Integrity

Table 2: Operating Conditions of Various Unit Processes of the AWT Pilot Train

Process	Operating Parameters
<u>Ultrafiltration</u>	Target Flux = 30 - 40 gfd
	Transmembrane pressure = 1 -10 psi
	Backwash frequency = 15-30 min
	Flow mode = direct flow (no recirculation)
	Free chlorine dose during backwash = 0-10 mg/L
	Chemical cleaning (per mfg recommendation)
<u>Reverse Osmosis</u>	Target Flux = 10-12 gfd
	Recovery 75-85%
	Feed pH = 7 - 8
	Antiscalant dose = 2 mg/L
	Combined chlorine feed dose = 1-2 mg/L
	Chemical cleaning (per mfg recommendation)
<u>UV</u>	Flow ~ 100 gpm
	Lamp Power ~ 1200 W
	Lamp Power Setting = 60%
	Hydrogen Peroxide Dose = 5 mg/L

Table 3: EDC/PCP Target List

Compound	Use	MDL (ng/L)
Hydrocodone	pain relieve	1
Trimethoprim	anti-biotic	1
Acetaminophen	analgesic	1
Caffeine	stimulant	10
Erythromycin-H ₂ O	anti-biotic	1
Sulfamethoxazole	anti-biotic	1
Fluoxetine	anti-depressant	1
Pentoxifylline	resude blood viscosity	1
Meprobamate	anti-anxiety	1
Dilantin	anti-convulsant	1
TCEP	fire retardent	10
Carbamazepine	anti-seizure/analgesic	1
DEET	mosquito repllant	1
Atrazine	herbicide	1
Diazepam	muscle relaxant/anti-anxiety	1
Oxybenzone	sunscreen	1
Estriol	steriod	5
Ethynylestradiol	synthetic birth control	1
Estrone	steriod	1
Estradiol	steriod	1
Testosterone	steriod	1
Progesterone	steriod	1
Androstenedione	steriod	1
Iopromide	x-ray contrast reagent	1
Naproxen	analgesic	1
Ibuprofen	pain relieve	1
Diclofenac	treatment of arthritis	1
Triclosan	anti-biotic	1
Gemfibrozil	anti-cholesterol	1

Table 4: Target EDC and PPCP

Chemical	Usage Category	Mass available (purchased)	Supplier	Form	Concentration
TCEP	Fire Retardant	25 g	Sigma Aldrich	Liquid	97.0%
Oxybenzone	Sunscreen	5 g	Sigma Aldrich	Powder	98.0%
Caffeine	Stimulant	25 g	Fluka	Powder	99.0%
Triclosan (Irgasan)	Germicide	5 g	Fluka	Powder	97.0%
DEET	Insecticide	250 mg	Sigma Aldrich	Liquid	97.3%
Ibuprofen	Analgesic	1 g	Sigma Aldrich	Powder	98.0%
Estrone	Hormone	1 g	Sigma Aldrich	Powder	99.0%
Iopromide	Contrast media	400 mg	USP	Powder	97.9%

Table 5: Water Quality Results (City of San Diego Water Quality Laboratory)

Parameter	Method	Units	MDL	Values for various sampling dates and locations									
				3/25/2005			4/13/2005			UV + Peroxide	7/14/2005 - 7/19/2005		
				Tertiary Effluent	RO Feed	RO Permeate	Tertiary Effluent	RO Feed	RO Permeate		Tertiary Effluent	RO Feed	RO Permeate
ALUMINUM	EPA200.8	UG/L	5	16.4	13.3	ND	10.7	7.89	ND	ND	7.74	9.67	ND
ANTIMONY	EPA200.8	UG/L	0.5	ND	ND	ND	ND	ND	ND	NA	0.622	0.614	ND
ARSENIC	EPA200.8	UG/L	1	2.03	1.93	ND	1.99	1.99	ND	ND	2.52	2.48	ND
BARIUM	EPA200.8	UG/L	1	57.2	56.3	ND	51.3	50.4	ND	ND	58.6	56.3	ND
BERYLLIUM	EPA200.8	UG/L	0.5	ND	ND	ND	ND	ND	ND	ND	ND	ND	ND
BORON	EPA200.8	UG/L	25	365	353	283	363	367	301	275	408	404	365
CADMIUM	EPA200.8	UG/L	0.5	ND	ND	ND	ND	ND	ND	ND	ND	ND	ND
COPPER	EPA200.8	UG/L	1	6.05	5.35	ND	6.37	4.96	ND	1.07	7.55	6.94	1.18
LEAD	EPA200.8	UG/L	0.5	ND	ND	ND	0.511	ND	ND	ND	ND	ND	ND
MANGANESE	EPA200.8	UG/L	0.5	119	115	ND	80	74.4	1.47	0.708	123	113	ND
NICKEL	EPA200.8	UG/L	1	5.22	5.36	ND	4.68	4.38	ND	ND	7.54	7.24	ND
SELENIUM	EPA200.8	UG/L	2	3.49	3.3	ND	2.88	2.86	ND	ND	3.57	3.98	ND
SILVER	EPA200.8	UG/L	0.5	ND	ND	ND	ND	ND	ND	ND	ND	ND	ND
THALLIUM	EPA200.8	UG/L	0.5	ND	ND	ND	ND	ND	ND	ND	ND	ND	ND
VANADIUM	EPA200.8	UG/L	1	3.45	3.37	ND	2.5	2.33	ND	ND	4	4.01	ND
ZINC	EPA200.8	UG/L	8	27.1	41.3	ND	31.4	30	ND	ND	28.7	25.8	ND
BROMIDE	EPA300A	MG/L	0.1	0.47	0.426	ND	0.469	0.479	ND	ND	0.427	0.373	ND
CHLORIDE	EPA300A	MG/L	1	268	276	7.93	248	248	7.02	7.33	249	270	8.63
NITRATE	EPA300A	MG/L	0.2	47.6	48.8	7.02	47.4	36.1	9.77	6.74	40.9	39.1	6.02
PHOSPHATE_O	EPA300A	MG/L	0.2	5.65	5.59	ND	5.07	5.08	ND	ND	5.29	5.37	ND
SULFATE	EPA300A	MG/L	0.5	233	234	0.769	215	214	0.679	0.656	275	196	0.721
ALKALINITY_PART	SM2320B	MG/L	0	ND	ND	ND	ND	ND	ND	ND	NA	NA	NA
ALKALINITY_TOT	SM2320B	MG/L	3	146	147	9.01	145	143	8.49	8.01	140	139	21.8
HARDNESS_TOTAL	SM2340	MG/L	2	352	356	4.4	342	338	5.32	3.27	374	389	12.2
CONDUCTIVITY	SM2510B	UMHO/CM		2420	2550	0.91	1640	1660	65	68	1810	1960	110
TDS	SM2540C	MG/L	10	934	1020	77	960	956	64	37	1100	1130	44
POTASSIUM	SM3111B	MG/L	0.5	16.2	16.1	0.956	18.1	18.1	1.04	ND	23.8	23.6	1.09
SODIUM	SM3111B	MG/L	20	184	184	ND	184	181	ND	ND	202	196	ND
HARDNESS_CA	SM3500_CA	MG/L	2	194	205	2.91	183	188	2.25	3.37	226	236	13.2
SILICA	SM4500SI	MG/L	0.5	18.4	18.2	0.714	15.7	15.9	0.667	0.607	14	13.7	0.63
TOC	SM5310B	MG/L	0.4	8.13	7.8	ND	7.98	7.51	ND	ND	10.2	NA	NA
1,2-dibromo-3-chloropropane	EPA504	UG/L	0.01	ND	ND	ND	ND	ND	ND	ND	ND	ND	ND
1,2-dibromoethane	EPA504	UG/L	0.01	ND	ND	ND	ND	ND	ND	ND	ND	ND	ND
Hexachlorobenzene	EPA505	UG/L	0.5	ND	ND	ND	ND	ND	ND	ND	ND	ND	ND
Hexachlorocyclopentadiene	EPA505	UG/L	0.2	ND	ND	ND	ND	ND	ND	ND	ND	ND	ND

Note: for some samples requiring dilution, the MDL was higher than that shown. “ND” indicates value is below the method detection limit (MDL); NA indicates sample not analyzed (sample bottles broken in transport).

Table 5 Cont.: Water Quality Results (City of San Diego Water Quality Laboratory)

Parameter	Method	Units	MDL	Values for various sampling dates and locations										
				3/25/2005			4/13/2005			UV + Peroxide	7/14/2005 - 7/19/2005			
				Tertiary Effluent	RO Feed	RO Permeate	Tertiary Effluent	RO Feed	RO Permeate		Tertiary Effluent	RO Feed	RO Permeate	
Aldrin	EPA505	UG/L	0.075	ND	ND	ND	ND	ND	ND	ND	ND	ND	ND	ND
Total Chlordane	EPA505	UG/L	0.1	ND	ND	ND	ND	ND	ND	ND	ND	ND	ND	ND
Dieldrin	EPA505	UG/L	0.02	ND	ND	ND	ND	ND	ND	ND	ND	ND	ND	ND
Endrin	EPA505	UG/L	0.1	ND	ND	ND	ND	ND	ND	ND	ND	ND	ND	ND
Heptachlor	EPA505	UG/L	0.01	ND	ND	ND	ND	ND	ND	ND	ND	ND	ND	ND
Heptachlor epoxide	EPA505	UG/L	0.01	ND	ND	ND	ND	ND	ND	ND	ND	ND	ND	ND
Lindane	EPA505	UG/L	0.2	ND	ND	ND	ND	ND	ND	ND	ND	ND	ND	ND
Methoxychlor	EPA505	UG/L	0.5	ND	ND	ND	ND	ND	ND	ND	ND	ND	ND	ND
PCB 1016 / 1242	EPA505	UG/L	0.5	ND	ND	ND	ND	ND	ND	ND	ND	ND	ND	ND
PCB 1221	EPA505	UG/L	0.5	ND	ND	ND	ND	ND	ND	ND	ND	ND	ND	ND
PCB 1232	EPA505	UG/L	0.5	ND	ND	ND	ND	ND	ND	ND	ND	ND	ND	ND
PCB 1248	EPA505	UG/L	0.5	ND	ND	ND	ND	ND	ND	ND	ND	ND	ND	ND
PCB 1254	EPA505	UG/L	0.5	ND	ND	ND	ND	ND	ND	ND	ND	ND	ND	ND
PCB 1260	EPA505	UG/L	0.5	ND	ND	ND	ND	ND	ND	ND	ND	ND	ND	ND
Propachlor	EPA505	UG/L	0.5	ND	ND	ND	ND	ND	ND	ND	ND	ND	ND	ND
Total Toxaphene	EPA505	UG/L	1	ND	ND	ND	ND	ND	ND	ND	ND	ND	ND	ND
1,1,1,2-tetrachloroethane	EPA524.2	UG/L	0.2	ND	ND	ND	ND	ND	ND	ND	ND	ND	ND	ND
1,1,1-trichloroethane	EPA524.2	UG/L	0.2	ND	ND	ND	ND	ND	ND	ND	ND	ND	ND	ND
1,1,2,2-tetrachloroethane	EPA524.2	UG/L	0.2	ND	ND	ND	ND	ND	ND	ND	ND	ND	ND	ND
1,1,2-trichloroethane	EPA524.2	UG/L	0.2	ND	ND	ND	ND	ND	ND	ND	ND	ND	ND	ND
1,1,2-trichlorotrifluoroethane	EPA524.2	UG/L	0.2	ND	ND	ND	ND	ND	ND	ND	ND	ND	ND	ND
1,1-dichloroethane	EPA524.2	UG/L	0.2	ND	ND	ND	ND	ND	ND	ND	ND	ND	ND	ND
1,1-dichloroethene	EPA524.2	UG/L	0.2	ND	ND	ND	ND	ND	ND	ND	ND	ND	ND	ND
1,1-dichloropropene	EPA524.2	UG/L	0.2	ND	ND	ND	ND	ND	ND	ND	ND	ND	ND	ND
1,2,3-trichlorobenzene	EPA524.2	UG/L	0.2	ND	ND	ND	ND	ND	ND	ND	ND	ND	ND	ND
1,2,4-trichlorobenzene	EPA524.2	UG/L	0.2	ND	ND	ND	ND	ND	ND	ND	ND	ND	ND	ND
1,2,4-trimethylbenzene	EPA524.2	UG/L	0.2	ND	ND	ND	ND	ND	ND	ND	ND	ND	ND	ND
1,2-dibromo-3-chloropropane	EPA524.2	UG/L	0.2	ND	ND	ND	ND	ND	ND	ND	ND	ND	ND	ND
1,2-dibromoethane	EPA524.2	UG/L	0.2	ND	ND	ND	ND	ND	ND	ND	ND	ND	ND	ND
1,2-dichlorobenzene	EPA524.2	UG/L	0.2	ND	ND	ND	ND	ND	ND	ND	ND	ND	ND	ND
1,2-dichloroethane	EPA524.2	UG/L	0.2	0.994	1.02	1.2	ND	ND	ND	ND	ND	ND	ND	ND
1,2-dichloropropane	EPA524.2	UG/L	0.2	ND	ND	ND	ND	ND	ND	ND	ND	ND	ND	ND
1,3,5-trimethylbenzene	EPA524.2	UG/L	0.2	ND	ND	ND	ND	ND	ND	ND	ND	ND	ND	ND
1,3-dichlorobenzene	EPA524.2	UG/L	0.2	ND	ND	ND	ND	ND	ND	ND	ND	ND	ND	ND
1,3-dichloropropane	EPA524.2	UG/L	0.2	ND	ND	ND	ND	ND	ND	ND	ND	ND	ND	ND

Note: for some samples requiring dilution, the MDL was higher than that shown. “ND” indicates value is below the method detection limit (MDL); NA indicates sample not analyzed (sample bottles broken in transport).

Table 5 Cont.: Water Quality Results (City of San Diego Water Quality Laboratory)

Parameter	Method	Units	MDL	Values for various sampling dates and locations										
				3/25/2005			4/13/2005				7/14/2005 - 7/19/2005			
				Tertiary Effluent	RO Feed	RO Permeate	Tertiary Effluent	RO Feed	RO Permeate	UV + Peroxide	Tertiary Effluent	RO Feed	RO Permeate	
1,4-dichlorobenzene	EPA524.2	UG/L	0.2	0.312	0.328	ND	0.29	ND	ND	ND	ND	ND	0.305	ND
2,2-dichloropropane	EPA524.2	UG/L	0.2	ND	ND	ND	ND	ND	ND	ND	ND	ND	ND	ND
Dibromomethane	EPA524.2	UG/L	0.2	ND	ND	ND	ND	ND	ND	ND	ND	ND	ND	ND
Dichlorodifluoromethane	EPA524.2	UG/L	0.2	ND	ND	ND	ND	ND	ND	ND	ND	ND	ND	ND
2-chlorotoluene	EPA524.2	UG/L	0.2	ND	ND	ND	ND	ND	ND	ND	ND	ND	ND	ND
Trichloroethylene	EPA524.2	UG/L	0.2	ND	ND	ND	ND	ND	ND	ND	ND	ND	ND	ND
Trichlorofluoromethane	EPA524.2	UG/L	0.2	ND	ND	ND	ND	ND	ND	ND	ND	ND	ND	ND
Tetrachloroethylene	EPA524.2	UG/L	0.2	ND	ND	ND	ND	0.31	ND	ND	ND	ND	ND	ND
4-chlorotoluene	EPA524.2	UG/L	0.2	ND	ND	ND	ND	ND	ND	ND	ND	ND	ND	ND
4-isopropyltoluene	EPA524.2	UG/L	0.2	ND	ND	ND	0.236	ND	ND	ND	ND	ND	ND	ND
Hexachlorobutadiene	EPA524.2	UG/L	0.2	ND	ND	ND	ND	ND	ND	ND	ND	ND	ND	ND
Benzene	EPA524.2	UG/L	0.2	ND	ND	ND	ND	ND	ND	ND	ND	ND	ND	ND
Bromodichloromethane	EPA524.2	UG/L	0.2	0.666	0.697	0.705	0.576	0.583	0.265	0.262	ND	0.518	0.408	ND
Bromochloromethane	EPA524.2	UG/L	0.2	ND	ND	ND	ND	ND	ND	ND	ND	0.232	ND	ND
Bromobenzene	EPA524.2	UG/L	0.2	ND	ND	ND	ND	ND	ND	ND	ND	ND	ND	ND
Bromoform	EPA524.2	UG/L	0.2	ND	ND	ND	ND	ND	ND	ND	ND	ND	ND	ND
Bromomethane	EPA524.2	UG/L	0.2	ND	ND	ND	ND	ND	ND	ND	ND	ND	ND	ND
Carbon tetrachloride	EPA524.2	UG/L	0.2	ND	ND	ND	ND	ND	ND	ND	ND	ND	ND	ND
Chlorobenzene	EPA524.2	UG/L	0.2	ND	ND	ND	ND	ND	ND	ND	ND	ND	ND	ND
Chloroethane	EPA524.2	UG/L	0.2	ND	ND	ND	ND	ND	ND	ND	ND	ND	ND	ND
Chloroform	EPA524.2	UG/L	0.2	1.62	1.71	1.44	2.39	2.76	1.75	1.56	ND	2.8	ND	ND
Chloromethane	EPA524.2	UG/L	0.2	ND	ND	ND	ND	ND	ND	ND	1.61	ND	1.79	ND
Chlorodibromomethane	EPA524.2	UG/L	0.2	0.533	0.566	0.487	0.55	0.549	0.21	ND	ND	ND	ND	ND
cis-1,2-dichloroethene	EPA524.2	UG/L	0.2	ND	ND	ND	ND	ND	ND	ND	ND	ND	ND	ND
cis-1,3-dichloropropene	EPA524.2	UG/L	0.2	ND	ND	ND	ND	ND	ND	ND	ND	ND	ND	ND
Di-Isopropyl-Ether	EPA524.2	UG/L	0.2	ND	ND	ND	ND	ND	ND	ND	ND	ND	ND	ND
Ethyl Tertiary Butyl Ether	EPA524.2	UG/L	0.2	ND	ND	ND	ND	ND	ND	ND	ND	ND	ND	ND
Ethylbenzene	EPA524.2	UG/L	0.2	ND	ND	ND	ND	ND	ND	ND	ND	ND	ND	ND
Isopropylbenzene	EPA524.2	UG/L	0.2	ND	ND	ND	ND	ND	ND	ND	ND	ND	ND	ND
Methylene chloride	EPA524.2	UG/L	0.2	0.571	0.569	0.538	ND	ND	ND	ND	0.256	0.397	0.262	ND
meta,para xylenes	EPA524.2	UG/L	0.2	ND	ND	ND	ND	ND	ND	ND	ND	ND	ND	ND
Methyl-tert-butyl ether	EPA524.2	UG/L	0.2	ND	ND	ND	ND	ND	ND	ND	ND	ND	ND	ND
Naphthalene	EPA524.2	UG/L	0.2	ND	ND	ND	ND	ND	ND	ND	ND	ND	ND	ND
n-butylbenzene	EPA524.2	UG/L	0.2	ND	ND	ND	ND	ND	ND	ND	ND	ND	ND	ND

Note: some samples requiring dilution, the MDL was higher than that shown. “ND” indicates value is below the method detection limit (MDL); NA indicates sample not analyzed (sample bottles broken in transport).

Table 5 Cont.: Water Quality Results (City of San Diego Water Quality Laboratory)

Parameter	Method	Units	MDL	Values for various sampling dates and locations										
				3/25/2005			4/13/2005				7/14/2005 - 7/19/2005			
				Tertiary Effluent	RO Feed	RO Permeate	Tertiary Effluent	RO Feed	RO Permeate	UV + Peroxide	Tertiary Effluent	RO Feed	RO Permeate	
n-propylbenzene	EPA524.2	UG/L	0.2	ND	ND	ND	ND	ND	ND	ND	ND	ND	ND	ND
ORTHO_XYLENE	EPA524.2	UG/L	0.2	ND	ND	ND	ND	ND	ND	ND	ND	ND	ND	ND
sec-butylbenzene	EPA524.2	UG/L	0.2	ND	ND	ND	ND	ND	ND	ND	ND	ND	ND	ND
Styrene	EPA524.2	UG/L	0.2	ND	ND	ND	ND	ND	ND	ND	ND	ND	ND	ND
Tertiary amyl methyl ether	EPA524.2	UG/L	0.2	ND	ND	ND	ND	ND	ND	ND	ND	ND	ND	ND
tert-butylbenzene	EPA524.2	UG/L	0.2	ND	ND	ND	ND	ND	ND	ND	ND	ND	ND	ND
Toluene	EPA524.2	UG/L	0.2	ND	ND	ND	ND	ND	ND	ND	ND	ND	ND	ND
trans-1,2-dichloroethene	EPA524.2	UG/L	0.2	ND	ND	ND	ND	ND	ND	ND	ND	ND	ND	ND
trans-1,3-dichloropropene	EPA524.2	UG/L	0.2	ND	ND	ND	ND	ND	ND	ND	ND	ND	ND	ND
t-Butyl alcohol	EPA524.2	UG/L	1.7	ND	ND	ND	ND	ND	ND	ND	ND	ND	ND	ND
Vinyl chloride	EPA524.2	UG/L	0.2	ND	ND	ND	ND	ND	ND	ND	ND	ND	ND	ND
Benzo(A)anthracene	EPA525.2	UG/L	0.5	ND	ND	ND	ND	ND	ND	ND	ND	ND	ND	ND
Diethyl phthalate	EPA525.2	UG/L	0.5	ND	ND	ND	ND	ND	ND	ND	ND	ND	ND	ND
Dimethyl phthalate	EPA525.2	UG/L	0.5	ND	ND	ND	ND	ND	ND	ND	ND	NA	NA	NA
Di-n-butyl phthalate	EPA525.2	UG/L	2	ND	ND	ND	ND	ND	ND	ND	ND	ND	ND	ND
Hexachlorobenzene	EPA525.2	UG/L	0.4	ND	ND	ND	ND	ND	ND	ND	ND	ND	ND	ND
Hexachlorocyclopentadiene	EPA525.2	UG/L	0.5	ND	ND	ND	ND	ND	ND	ND	ND	ND	NA	NA
Acenaphthylene	EPA525.2	UG/L	0.5	ND	ND	ND	ND	ND	ND	ND	ND	ND	ND	ND
Alachlor	EPA525.2	UG/L	0.5	ND	ND	ND	ND	ND	ND	ND	ND	ND	ND	ND
Anthracene	EPA525.2	UG/L	0.5	ND	ND	ND	ND	ND	ND	ND	ND	ND	ND	ND
Atrazine	EPA525.2	UG/L	0.4	ND	ND	ND	ND	ND	ND	ND	ND	ND	ND	ND
Bis(2-ethylhexyl)adipate	EPA525.2	UG/L	2	ND	ND	ND	ND	ND	ND	ND	ND	ND	ND	ND
Bis-(2-ethylhexyl) phthalate	EPA525.2	UG/L	3	ND	ND	ND	ND	ND	ND	ND	ND	ND	ND	ND
Benzo(A)anthracene	EPA525.2	UG/L	0.5	ND	ND	ND	ND	ND	ND	ND	ND	ND	ND	ND
Benzo(A)pyrene	EPA525.2	UG/L	0.1	ND	ND	ND	ND	ND	ND	ND	ND	ND	ND	ND
Benzo(b)fluoroanthene	EPA525.2	UG/L	0.5	ND	ND	ND	ND	ND	ND	ND	ND	ND	ND	ND
Benzo(G,H,I)perylene	EPA525.2	UG/L	0.5	ND	ND	ND	ND	ND	ND	ND	ND	ND	ND	ND
Benzo(K)fluoranthene	EPA525.2	UG/L	0.5	ND	ND	ND	ND	ND	ND	ND	ND	ND	ND	ND
BHC, Gamma isomer	EPA525.2	UG/L	0.5	ND	ND	ND	ND	ND	ND	ND	ND	ND	ND	ND
Butyl benzyl phthalate	EPA525.2	UG/L	0.5	ND	ND	ND	ND	ND	ND	ND	ND	ND	ND	ND
Chrysene	EPA525.2	UG/L	0.5	ND	ND	ND	ND	ND	ND	ND	ND	ND	ND	ND
Endrin	EPA525.2	UG/L	0.1	ND	ND	ND	ND	ND	ND	ND	ND	ND	ND	ND
Fluorene	EPA525.2	UG/L	0.5	ND	ND	ND	ND	ND	ND	ND	ND	ND	ND	ND

Note: for some samples requiring dilution, the MDL was higher than that shown. "ND" indicates value is below the method detection limit (MDL); NA indicates sample not analyzed (sample bottles broken in transport).

Table 5 Cont.: Water Quality Results (City of San Diego Water Quality Laboratory)

Parameter	Method	Units	MDL	Values for various sampling dates and locations										
				3/25/2005			4/13/2005				7/14/2005 - 7/19/2005			
				Tertiary Effluent	RO Feed	RO Permeate	Tertiary Effluent	RO Feed	RO Permeate	UV + Peroxide	Tertiary Effluent	RO Feed	RO Permeate	
Indeno(1,2,3-CD)pyrene	EPA525.2	UG/L	0.5	ND	ND	ND	ND	ND	ND	ND	ND	ND	ND	ND
Methoxychlor	EPA525.2	UG/L	0.5	ND	ND	ND	ND	ND	ND	ND	ND	ND	ND	ND
Molinate	EPA525.2	UG/L	0.5	ND	ND	ND	ND	ND	ND	ND	ND	ND	ND	ND
Naphthalene	EPA525.2	UG/L	0.4	ND	ND	ND	ND	ND	ND	ND	ND	ND	ND	ND
Phenanthrene	EPA525.2	UG/L	0.5	ND	ND	ND	ND	ND	ND	ND	ND	ND	ND	ND
Propachlor	EPA525.2	UG/L	0.4	ND	ND	ND	ND	ND	ND	ND	ND	ND	ND	ND
Pyrene	EPA525.2	UG/L	0.5	ND	ND	ND	ND	ND	ND	ND	ND	ND	ND	ND
Simazine *	EPA525.2	UG/L	0.5	ND	ND	ND	ND	ND	ND	ND	NA	NA	NA	NA
Trifluralin	EPA525.2	UG/L	0.5	ND	ND	ND	ND	ND	ND	ND	ND	ND	ND	ND
3-Hydroxycarbofuran	EPA531.1	UG/L	0.4	ND	ND	ND	ND	ND	ND	ND	ND	ND	ND	ND
Aldicarb	EPA531.1	UG/L	0.4	ND	ND	ND	ND	ND	ND	ND	ND	ND	ND	ND
Aldicarb sulfone	EPA531.1	UG/L	0.4	ND	ND	ND	ND	ND	ND	ND	ND	ND	ND	ND
Aldicarb sulfoxide	EPA531.1	UG/L	0.4	ND	ND	ND	ND	ND	ND	ND	ND	ND	ND	ND
Baygon	EPA531.1	UG/L	0.4	ND	ND	ND	ND	ND	ND	ND	ND	ND	ND	ND
Carbaryl	EPA531.1	UG/L	0.4	ND	ND	ND	ND	ND	ND	ND	ND	ND	ND	ND
Carbofuran	EPA531.1	UG/L	0.4	ND	ND	ND	ND	ND	ND	ND	ND	ND	ND	ND
Methiocarb	EPA531.1	UG/L	0.4	ND	ND	ND	ND	ND	ND	ND	ND	ND	ND	ND
Methomyl	EPA531.1	UG/L	0.4	ND	ND	ND	ND	ND	ND	ND	ND	ND	ND	ND
Oxamyl	EPA531.1	UG/L	0.4	ND	ND	ND	ND	ND	ND	ND	ND	ND	ND	ND
Diquat	EPA548.1	UG/L	3	ND	ND	ND	ND	ND	ND	ND	NA	NA	NA	NA
Paraquat	EPA549	UG/L	4	ND	ND	ND	ND	ND	ND	ND	NA	NA	NA	NA
Dalapon	EPA549	UG/L	2	ND	ND	ND	ND	ND	ND	ND	ND	ND	ND	ND
Dibromoacetic acid	EPA552.2_HAA5	UG/L	1	ND	ND	ND	ND	ND	ND	ND	ND	ND	ND	ND
Dichloroacetic acid	EPA552.2_HAA5	UG/L	1	ND	ND	ND	ND	ND	ND	ND	ND	ND	ND	ND
HAA5	EPA552.2_HAA5	UG/L	1	1.48	1.47	ND	ND	ND	ND	ND	6.33	6.32	NA	NA
Monobromoacetic acid	EPA552.2_HAA5	UG/L	1	ND	ND	ND	ND	ND	ND	ND	ND	ND	ND	ND
Monochloroacetic acid	EPA552.2_HAA5	UG/L	2	ND	ND	ND	ND	ND	ND	ND	ND	ND	ND	ND
Trichloroacetic acid	EPA552.2_HAA5	UG/L	1	1.48	1.47	ND	ND	ND	ND	ND	6.33	6.32	ND	ND
2,4,5-T	EPA552.2_HAA5	UG/L	3	ND	ND	ND	ND	ND	ND	ND	ND	ND	ND	ND
2,4,5-TP (Silvex)	EPA555	UG/L	1	ND	ND	ND	ND	ND	ND	ND	ND	ND	ND	ND
2,4-D	EPA555	UG/L	3	ND	ND	ND	ND	ND	ND	ND	ND	ND	ND	ND
2,4-DB	EPA555	UG/L	3	ND	ND	ND	ND	ND	ND	ND	ND	ND	ND	ND
3,5-Dichlorobenzoic Acid	EPA555	UG/L	3	ND	ND	ND	ND	ND	ND	ND	ND	ND	ND	ND
4-nitrophenol	EPA555	UG/L	3	ND	ND	ND	ND	ND	ND	ND	ND	ND	ND	ND
Pentachlorophenol	EPA555	UG/L	0.2	ND	ND	ND	ND	ND	ND	ND	ND	ND	ND	ND

Note: for some samples requiring dilution, the MDL was higher than that shown. "ND" indicates value is below the method detection limit (MDL); NA indicates sample not analyzed (sample bottles broken in transport).

Table 5 Cont.: Water Quality Results (City of San Diego Water Quality Laboratory)

Parameter	Method	Units	MDL	Values for various sampling dates and locations										
				3/25/2005			4/13/2005				7/14/2005 - 7/19/2005			
				Tertiary Effluent	RO Feed	RO Permeate	Tertiary Effluent	RO Feed	RO Permeate	UV + Peroxide	Tertiary Effluent	RO Feed	RO Permeate	
Acifluorfen	EPA555	UG/L	3	ND	ND	ND	ND	ND	ND	ND	ND	ND	ND	ND
Bentazon	EPA555	UG/L	2	ND	ND	ND	ND	ND	ND	ND	ND	ND	ND	ND
Chloramben	EPA555	UG/L	3	ND	ND	ND	ND	ND	ND	ND	ND	ND	ND	ND
Dicamba	EPA555	UG/L	1.5	ND	ND	ND	ND	ND	ND	ND	ND	ND	ND	ND
Dichlorprop	EPA555	UG/L	3	ND	ND	ND	ND	ND	ND	ND	ND	ND	ND	ND
Dinoseb	EPA555	UG/L	2	ND	ND	ND	ND	ND	ND	ND	ND	ND	ND	ND
MCPA	EPA555	UG/L	3	ND	ND	ND	ND	ND	ND	ND	ND	ND	ND	ND
MCPP	EPA555	UG/L	3	ND	ND	ND	ND	ND	ND	ND	ND	ND	ND	ND
Picloram	EPA555	UG/L	1	ND	ND	ND	ND	ND	ND	ND	ND	ND	ND	ND
Thiobencarb	EPA555	UG/L	1	ND	ND	ND	ND	ND	ND	ND	ND	ND	ND	ND

Note: for some samples requiring dilution, the MDL was higher than that shown. "ND" indicates value is below the method detection limit (MDL); NA indicates sample not analyzed (sample bottles broken in transport).

Table 6: Water Quality Results (MWH Laboratory)

Parameter	Method	Units	1MDL	Values for various sampling dates and locations										
				3/23/2005		4/13/2005					12/12/2005			
				RO Feed	RO Permeate	RO Feed	RO Permeate	UV + Peroxide	Alvarado Lake	Miramar Lake	RO Feed	RO Permeate	UV + Peroxide	
Atrazine	ML/EPA 525.2	ug/l	0.05	ND	ND	ND	ND	ND	ND	ND	ND	ND	ND	ND
Benzo(a)pyrene	ML/EPA 525.2	ug/l	0.02	ND	ND	ND	ND	ND	ND	ND	ND	ND	ND	ND
Di(2-Ethylhexyl)phthalate	ML/EPA 525.2	ug/l	0.6	ND	ND	ND	ND	ND	ND	ND	ND	ND	ND	ND
Di-(2-Ethylhexyl)adipate	ML/EPA 525.2	ug/l	0.6	ND	ND	ND	ND	ND	ND	ND	ND	ND	ND	ND
Hexachlorobenzene	ML/EPA 525.2	ug/l	0.05	ND	ND	ND	ND	ND	ND	ND	ND	ND	ND	ND
Hexachlorocyclopentadiene	ML/EPA 525.2	ug/l	0.05	ND	ND	ND	ND	ND	ND	ND	ND	ND	ND	ND
Molinate	ML/EPA 525.2	ug/l	0.2	ND	ND	ND	ND	ND	ND	ND	ND	ND	ND	ND
Simazine	ML/EPA 525.2	ug/l	0.05	ND	ND	ND	ND	ND	ND	ND	ND	ND	ND	ND
Thiobencarb	ML/EPA 525.2	ug/l	0.2	ND	ND	ND	ND	ND	ND	ND	ND	ND	ND	ND
1,4-Dioxane	ML/SW 8270 mod	ug/l	2	43	6.9	ND	ND	ND	ND	ND	71	4.7	2.8	
Diquat	ML/EPA 549.2	ug/l	0.4	ND	ND	ND	ND	ND	ND	ND	ND	ND	ND	ND
Paraquat	ML/EPA 549.2	ug/l	2	ND	ND	ND	ND	ND	ND	ND	ND	ND	ND	ND
Dibromochloropropane (DBCP)	ML/EPA 504.1	ug/l	0.01	ND	ND	ND	ND	ND	ND	ND	ND	ND	ND	ND
Ethylene Dibromide (EDB)	ML/EPA 504.1	ug/l	0.01	ND	ND	ND	ND	ND	ND	ND	ND	ND	ND	ND
Alachlor (Alanex)	ML/EPA 505	ug/l	0.1	ND	ND	ND	ND	ND	ND	ND	ND	ND	ND	ND
Aldrin	ML/EPA 505	ug/l	0.01	ND	ND	ND	ND	ND	ND	ND	ND	ND	ND	ND
Chlordane	ML/EPA 505	ug/l	0.1	ND	ND	ND	ND	ND	ND	ND	ND	ND	ND	ND
Dieldrin	ML/EPA 505	ug/l	0.01	ND	ND	ND	ND	ND	ND	ND	ND	ND	ND	ND
Endrin	ML/EPA 505	ug/l	0.01	ND	ND	ND	ND	ND	ND	ND	ND	ND	ND	ND
Heptachlor	ML/EPA 505	ug/l	0.01	ND	ND	ND	ND	ND	ND	ND	ND	ND	ND	ND
Heptachlor Epoxide	ML/EPA 505	ug/l	0.01	ND	ND	ND	ND	ND	ND	ND	ND	ND	ND	ND
Lindane (gamma-BHC)	ML/EPA 505	ug/l	0.01	ND	ND	ND	ND	ND	ND	ND	ND	ND	ND	ND
Methoxychlor	ML/EPA 505	ug/l	0.05	ND	ND	ND	ND	ND	ND	ND	ND	ND	ND	ND
PCB 1016 Aroclor	ML/EPA 505	ug/l	0.07	ND	ND	ND	ND	ND	ND	ND	ND	ND	ND	ND
PCB 1221 Aroclor	ML/EPA 505	ug/l	0.1	ND	ND	ND	ND	ND	ND	ND	ND	ND	ND	ND
PCB 1232 Aroclor	ML/EPA 505	ug/l	0.1	ND	ND	ND	ND	ND	ND	ND	ND	ND	ND	ND
PCB 1242 Aroclor	ML/EPA 505	ug/l	0.1	ND	ND	ND	ND	ND	ND	ND	ND	ND	ND	ND
PCB 1248 Aroclor	ML/EPA 505	ug/l	0.1	ND	ND	ND	ND	ND	ND	ND	ND	ND	ND	ND
PCB 1254 Aroclor	ML/EPA 505	ug/l	0.1	ND	ND	ND	ND	ND	ND	ND	ND	ND	ND	ND
PCB 1260 Aroclor	ML/EPA 505	ug/l	0.1	ND	ND	ND	ND	ND	ND	ND	ND	ND	ND	ND
Total PCBs	ML/EPA 505	ug/l	0.07	ND	ND	ND	ND	ND	ND	ND	ND	ND	ND	ND
Toxaphene	ML/EPA 505	ug/l	0.5	ND	ND	ND	ND	ND	ND	ND	ND	ND	ND	ND
2,4,5-T	ML/EPA 515.4	ug/l	0.2	ND	ND	ND	ND	ND	ND	ND	ND	ND	ND	ND
2,4,5-TP (Silvex)	ML/EPA 515.4	ug/l	0.2	ND	ND	ND	ND	ND	ND	ND	ND	ND	ND	ND
2,4-D	ML/EPA 515.4	ug/l	0.1	ND	ND	ND	ND	ND	ND	ND	ND	ND	ND	ND
2,4-DB	ML/EPA 515.4	ug/l	2	ND	ND	ND	ND	ND	ND	ND	ND	ND	ND	ND
3,5-Dichlorobenzoic acid	ML/EPA 515.4	ug/l	0.5	ND	ND	ND	ND	ND	ND	ND	ND	ND	ND	ND
Acifluorfen	ML/EPA 515.4	ug/l	0.2	ND	ND	ND	ND	ND	ND	ND	ND	ND	ND	ND
Bentazon	ML/EPA 515.4	ug/l	0.5	ND	ND	ND	ND	ND	ND	ND	ND	ND	ND	ND
Dalapon	ML/EPA 515.4	ug/l	1	ND	ND	ND	ND	ND	ND	ND	ND	ND	ND	ND
Dicamba	ML/EPA 515.4	ug/l	0.08	ND	ND	ND	ND	ND	ND	ND	ND	ND	ND	ND
Dichlorprop	ML/EPA 515.4	ug/l	0.5	ND	ND	ND	ND	ND	ND	ND	ND	ND	ND	ND

¹ For some samples requiring dilution, the MDL was higher than that shown. “ND” indicates value is below the method detection limit (MDL); NA indicates sample not analyzed (sample bottles broken in transport).

Table 6 Cont.: Water Quality Results (MWH Laboratory)

Parameter	Method	Units	MDL	Values for various sampling dates and locations										
				3/23/2005		4/13/2005					12/12/2005			
				RO Feed	RO Permeate	RO Feed	RO Permeate	UV + Peroxide	Alvarado Lake	Miramar Lake	RO Feed	RO Permeate	UV + Peroxide	
Dinoseb	ML/EPA 515.4	ug/l	0.2	ND	ND	ND	ND	ND	ND	ND	ND	ND	ND	ND
Pentachlorophenol	ML/EPA 515.4	ug/l	0.04	ND	ND	ND	ND	ND	ND	ND	ND	ND	ND	ND
Picloram	ML/EPA 515.4	ug/l	0.1	ND	ND	ND	ND	ND	ND	ND	ND	ND	ND	ND
Tot DCPA Mono&Diacid Degradate	ML/EPA 515.4	ug/l	1	ND	ND	ND	ND	ND	ND	ND	ND	ND	ND	ND
3-Hydroxycarbofuran	ML/EPA 531.2	ug/l	0.5	ND	ND	ND	ND	ND	ND	ND	ND	ND	ND	ND
Aldicarb (Temik)	ML/EPA 531.2	ug/l	0.5	ND	ND	ND	ND	ND	ND	ND	ND	ND	ND	ND
Aldicarb sulfone	ML/EPA 531.2	ug/l	0.5	ND	ND	1.89	ND	ND	ND	ND	1.6	ND	ND	ND
Aldicarb sulfoxide	ML/EPA 531.2	ug/l	0.5	ND	ND	ND	ND	ND	ND	ND	ND	ND	ND	ND
Baygon (Propoxur)	ML/EPA 531.2	ug/l	0.5	ND	ND	ND	ND	ND	ND	ND	ND	ND	ND	ND
Carbaryl	ML/EPA 531.2	ug/l	0.5	ND	ND	ND	ND	ND	ND	ND	ND	ND	ND	ND
Carbofuran (Furadan)	ML/EPA 531.2	ug/l	0.5	ND	ND	ND	ND	ND	ND	ND	ND	ND	ND	ND
Methiocarb	ML/EPA 531.2	ug/l	0.5	ND	ND	ND	ND	ND	ND	ND	ND	ND	ND	ND
Methomyl	ML/EPA 531.2	ug/l	0.5	ND	ND	ND	ND	ND	ND	ND	ND	ND	ND	ND
Oxamyl (Vydate)	ML/EPA 531.2	ug/l	0.5	ND	ND	ND	ND	ND	ND	ND	ND	ND	ND	ND
N-Nitroso dimethylamine (NDMA)	MD/EPA 1625MOD	ng/l	2	14	10	23	18	ND	ND	ND	18	12	2.3	
Radium 228	ML/EPA 904.0	pCi/l	1	<1	<1	<1	<1	<1	<1	<1	<1	<1	<1	<1
Alpha, Gross	ML/EPA 900.0	pCi/l	3	<3.00	<3.00	<3.00	<3.00	<3.00	<3.00	<3.00	<3.00	<3.00	<3.00	<3.00
Beta, Gross	ML/EPA 900.0	pCi/l	3	9.9	<3.00	13	<3.00	<3.00	3.4	3.3	<3.00	<3.00	<3.00	<3.00
1,1,1,2-Tetrachloroethane	ML/EPA 524.2	ug/l	0.5	ND	ND	ND	ND	ND	ND	ND	ND	ND	ND	ND
1,1,1-Trichloroethane	ML/EPA 524.2	ug/l	0.5	ND	ND	ND	ND	ND	ND	ND	ND	ND	ND	ND
1,1,2,2-tetrachloroethane	ML/EPA 524.2	ug/l	0.5	ND	ND	ND	ND	ND	ND	ND	ND	ND	ND	ND
1,1,2-Trichloroethane	ML/EPA 524.2	ug/l	0.5	ND	ND	ND	ND	ND	ND	ND	ND	ND	ND	ND
1,1-Dichloroethane	ML/EPA 524.2	ug/l	0.5	ND	ND	ND	ND	ND	ND	ND	ND	ND	ND	ND
1,1-Dichloroethylene	ML/EPA 524.2	ug/l	0.5	ND	ND	ND	ND	ND	ND	ND	ND	ND	ND	ND
1,1-Dichloropropene	ML/EPA 524.2	ug/l	0.5	ND	ND	ND	ND	ND	ND	ND	ND	ND	ND	ND
1,2,3-Trichlorobenzene	ML/EPA 524.2	ug/l	0.5	ND	ND	ND	ND	ND	ND	ND	ND	ND	ND	ND
1,2,3-Trichloropropane	ML/EPA 524.2	ug/l	0.5	ND	ND	ND	ND	ND	ND	ND	ND	ND	ND	ND
1,2,4-Trichlorobenzene	ML/EPA 524.2	ug/l	0.5	ND	ND	ND	ND	ND	ND	ND	ND	ND	ND	ND
1,2,4-Trimethylbenzene	ML/EPA 524.2	ug/l	0.5	ND	ND	ND	ND	ND	ND	ND	ND	ND	ND	ND
1,2-Dichloroethane	ML/EPA 524.2	ug/l	0.5	1.1	1.2	ND	ND	ND	ND	ND	ND	ND	ND	ND
1,2-Dichloropropane	ML/EPA 524.2	ug/l	0.5	ND	ND	ND	ND	ND	ND	ND	ND	ND	ND	ND
1,3,5-Trimethylbenzene	ML/EPA 524.2	ug/l	0.5	ND	ND	ND	ND	ND	ND	ND	ND	ND	ND	ND
1,3-Dichloropropane	ML/EPA 524.2	ug/l	0.5	ND	ND	ND	ND	ND	ND	ND	ND	ND	ND	ND
2,2-Dichloropropane	ML/EPA 524.2	ug/l	0.5	ND	ND	ND	ND	ND	ND	ND	ND	ND	ND	ND
2-Butanone (MEK)	ML/EPA 524.2	ug/l	5	ND	ND	ND	ND	ND	ND	ND	ND	ND	ND	ND
4-Methyl-2-Pentanone (MIBK)	ML/EPA 524.2	ug/l	5	ND	ND	ND	ND	ND	ND	ND	ND	ND	ND	ND
Benzene	ML/EPA 524.2	ug/l	0.5	ND	ND	ND	ND	ND	ND	ND	ND	ND	ND	ND
Bromobenzene	ML/EPA 524.2	ug/l	0.5	ND	ND	ND	ND	ND	ND	ND	ND	ND	ND	ND
Bromochloromethane	ML/EPA 524.2	ug/l	0.5	ND	ND	ND	ND	ND	ND	ND	0.6	ND	ND	ND
Bromodichloromethane	ML/EPA 524.2	ug/l	0.5	0.8	0.9	0.8	0.6	0.5	ND	1	0.6	1	0.9	
Bromoethane	ML/EPA 524.2	ug/l	0.5	ND	ND	ND	ND	ND	ND	ND	ND	ND	ND	ND
Bromoform	ML/EPA 524.2	ug/l	0.5	ND	ND	ND	ND	ND	ND	ND	ND	ND	ND	ND

¹ For some samples requiring dilution, the MDL was higher than that shown. "ND" indicates value is below the method detection limit (MDL); NA indicates sample not analyzed (sample bottles broken in transport).

Table 6 Cont.: Water Quality Results (MWH Laboratory)

Parameter	Method	Units	1MDL	Values for various sampling dates and locations										
				3/23/2005		4/13/2005					12/12/2005			
				RO Feed	RO Permeate	RO Feed	RO Permeate	UV + Peroxide	Alvarado Lake	Miramar Lake	RO Feed	RO Permeate	UV + Peroxide	
Bromomethane (Methyl Bromide)	ML/EPA 524.2	ug/l	0.5	ND	ND	ND	ND	ND	ND	ND	ND	ND	ND	ND
Carbon Tetrachloride	ML/EPA 524.2	ug/l	0.5	ND	ND	ND	ND	ND	ND	ND	ND	ND	ND	ND
Chlorobenzene	ML/EPA 524.2	ug/l	0.5	ND	ND	ND	ND	ND	ND	ND	ND	ND	ND	ND
Chlorodibromomethane	ML/EPA 524.2	ug/l	0.5	0.6	0.6	0.6	ND	ND	ND	0.8	ND	0.6	ND	ND
Chloroethane	ML/EPA 524.2	ug/l	0.5	ND	ND	ND	ND	ND	ND	ND	ND	ND	ND	ND
Chloroform (Trichloromethane)	ML/EPA 524.2	ug/l	0.5	2.2	1.8	3.4	2.3	2.3	ND	1.2	2.3	1.7	1.7	1.7
Chloromethane(Methyl Chloride)	ML/EPA 524.2	ug/l	0.5	ND	ND	ND	ND	ND	ND	ND	ND	ND	ND	ND
Di-isopropyl ether	ML/EPA 524.2	ug/l	3	ND	ND	ND	ND	ND	ND	ND	ND	ND	ND	ND
Dibromomethane	ML/EPA 524.2	ug/l	0.5	ND	ND	ND	ND	ND	ND	ND	ND	ND	ND	ND
Dichlorodifluoromethane	ML/EPA 524.2	ug/l	0.5	ND	ND	ND	ND	ND	ND	ND	ND	ND	ND	ND
Dichloromethane	ML/EPA 524.2	ug/l	0.5	0.7	0.7	ND	ND	ND	ND	ND	0.5	ND	ND	ND
Ethyl benzene	ML/EPA 524.2	ug/l	0.5	ND	ND	ND	ND	ND	ND	ND	ND	ND	ND	ND
Fluorotrichloromethane-Freon11	ML/EPA 524.2	ug/l	0.5	ND	ND	ND	ND	ND	ND	ND	ND	ND	ND	ND
Hexachlorobutadiene	ML/EPA 524.2	ug/l	0.5	ND	ND	ND	ND	ND	ND	ND	ND	ND	ND	ND
Isopropylbenzene	ML/EPA 524.2	ug/l	0.5	ND	ND	ND	ND	ND	ND	ND	ND	ND	ND	ND
Methyl Tert-butyl ether (MTBE)	ML/EPA 524.2	ug/l	1	ND	ND	ND	ND	ND	ND	ND	ND	ND	ND	ND
Naphthalene	ML/EPA 524.2	ug/l	0.5	ND	ND	ND	ND	ND	ND	ND	ND	ND	ND	ND
Styrene	ML/EPA 524.2	ug/l	0.5	ND	ND	ND	ND	ND	ND	ND	ND	ND	ND	ND
Tetrachloroethylene (PCE)	ML/EPA 524.2	ug/l	0.5	ND	ND	ND	ND	ND	ND	ND	ND	ND	ND	ND
Toluene	ML/EPA 524.2	ug/l	0.5	ND	ND	ND	ND	ND	ND	ND	1.1	ND	ND	ND
Total 1,3-Dichloropropene	ML/EPA 524.2	ug/l	0.5	ND	ND	ND	ND	ND	ND	ND	ND	ND	ND	ND
Total THM	ML/EPA 524.2	ug/l	0.5	3.6	3.4	4.8	2.8	2.8	ND	3	2.9	3.3	2.6	2.6
Total xylenes	ML/EPA 524.2	ug/l	0.5	ND	ND	ND	ND	ND	ND	ND	ND	ND	ND	ND
Trichloroethylene (TCE)	ML/EPA 524.2	ug/l	0.5	ND	ND	ND	ND	ND	ND	ND	ND	ND	ND	ND
Trichlorotrifluoroethane(Freon	ML/EPA 524.2	ug/l	0.5	ND	ND	ND	ND	ND	ND	ND	ND	ND	ND	ND
Vinyl chloride (VC)	ML/EPA 524.2	ug/l	0.3	ND	ND	ND	ND	ND	ND	ND	ND	ND	ND	ND
cis-1,2-Dichloroethylene	ML/EPA 524.2	ug/l	0.5	ND	ND	ND	ND	ND	ND	ND	ND	ND	ND	ND
cis-1,3-Dichloropropene	ML/EPA 524.2	ug/l	0.5	ND	ND	ND	ND	ND	ND	ND	ND	ND	ND	ND
m,p-Xylenes	ML/EPA 524.2	ug/l	0.5	ND	ND	ND	ND	ND	ND	ND	ND	ND	ND	ND
m-Dichlorobenzene (1,3-DCB)	ML/EPA 524.2	ug/l	0.5	ND	ND	ND	ND	ND	ND	ND	ND	ND	ND	ND
n-Butylbenzene	ML/EPA 524.2	ug/l	0.5	ND	ND	ND	ND	ND	ND	ND	ND	ND	ND	ND
n-Propylbenzene	ML/EPA 524.2	ug/l	0.5	ND	ND	ND	ND	ND	ND	ND	ND	ND	ND	ND
o-Chlorotoluene	ML/EPA 524.2	ug/l	0.5	ND	ND	ND	ND	ND	ND	ND	ND	ND	ND	ND
o-Dichlorobenzene (1,2-DCB)	ML/EPA 524.2	ug/l	0.5	ND	ND	ND	ND	ND	ND	ND	ND	ND	ND	ND
o-Xylene	ML/EPA 524.2	ug/l	0.5	ND	ND	ND	ND	ND	ND	ND	ND	ND	ND	ND
p-Chlorotoluene	ML/EPA 524.2	ug/l	0.5	ND	ND	ND	ND	ND	ND	ND	ND	ND	ND	ND
p-Dichlorobenzene (1,4-DCB)	ML/EPA 524.2	ug/l	0.5	ND	ND	ND	ND	ND	ND	ND	0.5	ND	ND	ND
p-Isopropyltoluene	ML/EPA 524.2	ug/l	0.5	ND	ND	ND	ND	ND	ND	ND	ND	ND	ND	ND
sec-Butylbenzene	ML/EPA 524.2	ug/l	0.5	ND	ND	ND	ND	ND	ND	ND	ND	ND	ND	ND
tert-Butyl Ethyl Ether	ML/EPA 524.2	ug/l	3	ND	ND	ND	ND	ND	ND	ND	ND	ND	ND	ND
tert-Butylbenzene	ML/EPA 524.2	ug/l	0.5	ND	ND	ND	ND	ND	ND	ND	ND	ND	ND	ND
tert-amyl Methyl Ether	ML/EPA 524.2	ug/l	3	ND	ND	ND	ND	ND	ND	ND	ND	ND	ND	ND
trans-1,2-Dichloroethylene	ML/EPA 524.2	ug/l	0.5	ND	ND	ND	ND	ND	ND	ND	ND	ND	ND	ND

¹ For some samples requiring dilution, the MDL was higher than that shown. “ND” indicates value is below the method detection limit (MDL); NA indicates sample not analyzed (sample bottles broken in transport).

Table 6 Cont.: Water Quality Results (MWH Laboratory)

Parameter	Method	Units	1MDL	Values for various sampling dates and locations										
				3/23/2005		4/13/2005				12/12/2005				
				RO Feed	RO Permeate	RO Feed	RO Permeate	UV + Peroxide	Alvarado Lake	Miramar Lake	RO Feed	RO Permeate	UV + Peroxide	
trans-1,3-Dichloropropene	ML/EPA 524.2	ug/l	0.5	ND	ND	ND	ND	ND	ND	ND	ND	ND	ND	ND
2,3,7,8 TCDD (Dioxin)	1613-Subbed	pg/l	5	ND	ND	ND	ND	ND	ND	ND	ND	ND	ND	ND
Alkalinity in CaCO3 units	SM2320B/E310.1	mg/l	2	153	5.88	146	5.87	5.51	116	119	172	8.97	7.37	
Aluminum, Total, ICAP/MS	ML/EPA 200.8	ug/l	25	ND	ND	ND	ND	ND	70	29	ND	ND	ND	
Anion Sum - Calculated	ML/SM1030E	meq/l	0.001	15.6	0.458	15.4	0.484	0.48	7.31	7.3	17.5	0.366	0.334	
Antimony, Total, ICAP/MS	ML/EPA 200.8	ug/l	1	ND	ND	ND	ND	ND	ND	ND	ND	ND	ND	
Apparent Color	ML/S2120B	ACU	3	35	3	30	ND	ND	15	10	30	ND	ND	
Arsenic, Total, ICAP/MS	ML/EPA 200.8	ug/l	1	2.1	ND	1.4	ND	ND	1.6	1.4	1.6	ND	ND	
Asbestos by TEM - >10 microns	ML/EPA 100.1/2	MFL	0.75	ND	ND	ND	ND	ND	ND	ND	ND	ND	ND	
Barium, Total, ICAP/MS	ML/EPA 200.8	ug/l	2	50	ND	48	ND	ND	73	76	40	ND	ND	
Beryllium, Total, ICAP/MS	ML/EPA 200.8	ug/l	1	ND	ND	ND	ND	ND	ND	ND	ND	ND	ND	
Bicarb.Alkalinity as HCO3,calc	SM2320B/E310.1	mg/l	0.001	187	7.26	178	7.19	6.75	141	145	210	10.9	9	
Cadmium, Total, ICAP/MS	ML/EPA 200.8	ug/l	0.5	ND	ND	ND	ND	ND	ND	ND	ND	ND	ND	
Calcium, Total, ICAP	ML/EPA 200.7	mg/l	1	76	ND	73	ND	ND	46	45	82	ND	ND	
Carbon Dioxide,Free(25C)-Calc.	SM4500-CO2-D	mg/l	0.001	18.7	18.3	14.2	5.72	5.37	3.55	2.3	10.9	ND	2.34	
Carbonate as CO3, Calculated	SM2320B/E310.1	mg/l	0.001	0.242	ND	0.291	0.00117	0.0011	0.728	1.19	ND	ND	ND	
Cation Sum - Calculated	ML/SM1030E	meq/l	0.001	15.7	0.435	15.4	0.504	0.478	7.1	7.09	17	0.296	0.3	
Chloride	ML/EPA 300.0	mg/l	10	250	7.9	250	8.3	8.4	79	78	280	5.2	5.1	
Chromium, Total, ICAP/MS	ML/EPA 200.8	ug/l	1	1.5	ND	2.2	ND	ND	ND	ND	4.9	ND	ND	
Copper, Total, ICAP/MS	ML/EPA 200.8	ug/l	2	4.6	ND	3.6	ND	ND	3.8	3	2.9	ND	ND	
Cyanide	SM4500CN-F	mg/l	0.025	ND	ND	ND	ND	ND	ND	ND	ND	ND	ND	
Endothall	ML/EPA 548.1	ug/l	20	ND	ND	ND	ND	ND	ND	ND	ND	ND	ND	
Fecal Coliform Bacteria	ML/SM9221C	MPN/100 mL	2	<2	<2	<2.0	NA	<2	NA	<2	<2	<2	<2	
Fluoride	SM4500F-C	mg/l	0.05	0.34	ND	0.3	ND	ND	0.22	0.21	0.34	ND	ND	
Glyphosate	ML/EPA 547	ug/l	6	ND	ND	ND	ND	ND	ND	ND	ND	ND	ND	
Hydroxide as OH, Calculated	SM2320B/E310.1	mg/l	0.001	0.003	ND	0.004	ND	ND	0.01	0.02	ND	ND	ND	
Iron, Total, ICAP	ML/EPA 200.7	mg/l	0.02	0.038	ND	0.037	ND	ND	0.034	0.036	0.064	ND	ND	
Lead, Total, ICAP/MS	ML/EPA 200.8	ug/l	0.5	ND	ND	ND	ND	ND	ND	ND	ND	0.64	ND	
Magnesium, Total, ICAP	ML/EPA 200.7	mg/l	0.1	39	ND	37	ND	ND	20	20	40	ND	ND	
Manganese, Total, ICAP/MS	ML/EPA 200.8	ug/l	2	130	ND	84	ND	ND	11	6.7	180	ND	ND	
Mercury	ML/EPA 245.1	ug/l	0.2	ND	ND	ND	ND	ND	ND	ND	ND	ND	ND	
Nickel, Total, ICAP/MS	ML/EPA 200.8	ug/l	5	5.8	ND	5.2	ND	ND	ND	ND	7.9	ND	ND	
Nitrate as NO3 by IC (calc)	ML/EPA 300.0	mg/l	1.8	43	6.3	47	7.2	7.3	2.8	ND	19	1.7	1.9	
Nitrate as Nitrogen by IC	ML/EPA 300.0	mg/l	0.4	9.7	1.4	11	1.6	1.6	0.64	ND	4.4	0.38	0.42	
Nitrite, Nitrogen by IC	ML/EPA 300.0	mg/l	0.4	ND	ND	ND	ND	ND	ND	ND	1.5	ND	ND	
Odor	ML/S2150B	TON	1	40	2	40	1	1	3	4	4	1	1	
pH	4500HB/ E 150	Units	0.001	7.3	5.9	7.4	6.4	6.4	7.9	8.1	7.5	7.2	6.8	
Perchlorate	EPA 314	ug/l	4	ND	ND	ND	ND	ND	ND	ND	ND	ND	ND	
Potassium, Total, ICAP	ML/EPA 200.7	mg/l	1	17	ND	17	1	ND	4.3	4	18	ND	ND	
Selenium, Total, ICAP/MS	ML/EPA 200.8	ug/l	5	ND	ND	ND	ND	ND	ND	ND	ND	ND	ND	
Silver, Total, ICAP/MS	ML/EPA 200.8	ug/l	0.5	ND	ND	ND	ND	ND	ND	ND	ND	ND	ND	
Sodium, Total, ICAP	ML/EPA 200.7	mg/l	1	190	10	190	11	11	70	71	210	6.8	6.9	

¹ For some samples requiring dilution, the MDL was higher than that shown. "ND" indicates value is below the method detection limit (MDL); NA indicates sample not analyzed (sample bottles broken in transport).

Table 6 Cont.: Water Quality Results (MWH Laboratory)

Parameter	Method	Units	MDL	Values for various sampling dates and locations									
				3/23/2005		4/13/2005					12/12/2005		
				RO Feed	RO Permeate	RO Feed	RO Permeate	UV + Peroxide	Alvarado Lake	Miramar Lake	RO Feed	RO Permeate	UV + Peroxide
Specific Conductance	ML/S2510B	umho/cm	2	1590	55	1530	60	62	711	723	1820	44	43
Sulfate	ML/EPA 300.0	mg/l	2	230	0.83	220	0.86	0.9	130	130	280	0.6	0.61
Surfactants	SM5540C/E425.1	mg/l	0.05	0.13	ND	0.09	ND	ND	0.052	ND	0.104	ND	ND
Thallium, Total, ICAP/MS	ML/EPA 200.8	ug/l	1	ND	ND	ND	ND	ND	ND	ND	ND	ND	ND
Total Coliform Bacteria	ML/SM9221B	MPN/100 mL	2	<2	4	8	NA	<2	NA	4	2	<2	<2
Total Dissolved Solid (TDS)	SM 2540C	mg/l	10	990	34	950	30	34	450	450	1040	10	48
Total Hardness as CaCO3 by ICP	ML/SM2340B	mg/l	3	350	ND	335	ND	ND	197	195	369	ND	ND
Total Nitrate, Nitrite-N, CALC	ML/EPA 300.0	mg/l	0.1	9.7	1.4	11	1.6	1.6	0.64	ND	5.9	0.38	0.42
Turbidity	ML/EPA 180.1	NTU	0.05	0.25	0.1	0.4	0.1	0.15	1.3	1.7	0.25	ND	0.25
Zinc, Total, ICAP/MS	ML/EPA 200.8	ug/l	5	33	ND	33	18	ND	7.6	ND	8.1	ND	ND

¹ For some samples requiring dilution, the MDL was higher than that shown. "ND" indicates value is below the method detection limit (MDL); NA indicates sample not analyzed (sample bottles broken in transport).

Table 7: Water Quality Results (SNWA Research Laboratory)

Parameter	Units	MDL	Values for various sampling dates and locations											
			3/23/2005			4/13/2005						12/30/2005		
			Tertiary Water	RO Feed	RO Permeate	Tertiary Effluent	RO Feed	RO Permeate	UV + Peroxide	Alvarado Lake	Miramar Lake	RO Feed	RO Permeate	UV + Peroxide
Hydrocodone	ng/L	1	80	91	<1.0	87	78	<1.0	<1.0	<1.0	<1.0	82	<1.0	<1.0
Trimethoprim	ng/L	1	383	427	2.2	346	335	2.6	<1.0	<1.0	<1.0	432	3.3	<1.0
Acetaminophen	ng/L	1	1	<1.0	<1.0	<1.0	<1.0	1.2	<1.0	<1.0	<1.0	<10	<1.0	LE
Caffeine	ng/L	10	<10	<10	<10	<10	<10	<10	<10	<10	<10	<100	<10	<10
Erythromycin-H ₂ O	ng/L	1	335	375	<1.0	311	286	<1.0	<1.0	<1.0	<1.0	309	<1.0	<1.0
Sulfamethoxazole	ng/L	1	758	834	3.7	817	787	3.6	<1.0	2.6	3.3	997	2.2	<1.0
Fluoxetine	ng/L	1	46	55	<1.0	36	37	<1.0	<1.0	<1.0	<1.0	28	<1.0	<1.0
Pentoxifylline	ng/L	1	<1.0	<1.0	<1.0	<1.0	<1.0	<1.0	<1.0	<1.0	<1.0	12	<1.0	<1.0
Meprobamate	ng/L	1	252	279	1.5	271	256	1.5	<1.0	3	4.3	327	<1.0	<1.0
Dilantin	ng/L	1	133	144	1	117	113	<1.0	<1.0	<1.0	1.7	174	<1.0	<1.0
TCEP	ng/L	10	353	360	<10	225	220	<10	<10	<10	<10	323	<10	<10
Carbamazepine	ng/L	1	223	254	1.6	327	309	2.4	<1.0	<1.0	1.5	249	<1.0	<1.0
DEET	ng/L	1	146	164	<1.0	393	375	2.6	<1.0	5.2	8.4	211	<5.0 ¹	<5.0 ¹
Atrazine	ng/L	1	1	<1.0	<1.0	1	1.1	<1.0	<1.0	1.6	2.3	<10	<1.0	<1.0
Diazepam	ng/L	1	4.5	10	<1.0	1.2	1	<1.0	<1.0	<1.0	<1.0	<10	<1.0	<1.0
Oxybenzone	ng/L	1	<1.0	<1.0	<1.0	1.4	1.4	<1.0	<1.0	<1.0	<1.0	41	<5.0 ¹	<5.0 ¹
Estriol	ng/L	5	<5.0	<5.0	<5.0	<5.0	<5.0	<5.0	<5.0	<5.0	<5.0	14	<5.0	<5.0
Ethinylestradiol	ng/L	1	<1.0	<1.0	<1.0	<1.0	<1.0	<1.0	<1.0	<1.0	<1.0	<1.0	<1.0	<1.0
Estrone	ng/L	1	18	16	<1.0	6.3	19	<1.0	<1.0	<1.0	<1.0	182	<1.0	<1.0
Estradiol	ng/L	1	<1.0	<1.0	<1.0	<1.0	<1.0	<1.0	<1.0	<1.0	<1.0	18	<1.0	<1.0
Testosterone	ng/L	1	<1.0	<1.0	<1.0	<1.0	<1.0	<1.0	<1.0	<1.0	<1.0	<1.0	<1.0	<1.0
Progesterone	ng/L	1	<1.0	<1.0	<1.0	<1.0	<1.0	<1.0	<1.0	<1.0	<1.0	<1.0	<1.0	<1.0
Androstenedione	ng/L	1	4.4	4.8	<1.0	4.9	3.7	<1.0	<1.0	<1.0	<1.0	6.2	<1.0	<1.0
Iopromide	ng/L	1	633	717	<1.0	453	681	1.4	<1.0	<1.0	1.4	583	<1.0	<1.0
Naproxen	ng/L	1	48	50	<1.0	23	31	<1.0	<1.0	<1.0	<1.0	479	1.2	<1.0
Ibuprofen	ng/L	1	24	27	<1.0	28	37	<1.0	<1.0	1.4	1.1	120	<1.0	<1.0
Diclofenac	ng/L	1	52	55	<1.0	71	104	<1.0	<1.0	<1.0	<1.0	74	<1.0	<1.0
Triclosan	ng/L	1	94 ²	127 ²	453 ²	171 ²	334 ²	172 ²	194 ²	236 ²	72 ²	324	3.4	<1.0
Gemfibrozil	ng/L	1	146	160	<1.0	222	343	<1.0	<1.0	<1.0	175	1700	1.3	<1.0

< indicates measured value is below MDL; LE=lab error (see Appendix C); ¹MDL for sample set to 5 ng/L (see Appendix C); ² samples contaminated (see Appendix C).

Table 8: Primary Drinking Water Standards for Measured Organic Parameters

Parameter	Units	Primary Drinking Water Standard, MCL	
		Federal	CA
Volatile Organic Compounds			
Benzene	mg/L	0.005	0.001
Carbon tetrachloride	mg/L	0.005	0.0005
1,2 Dichlorobenzene	mg/L	0.6	0.6
1,4 Dichlorobenzene	mg/L	0.075	0.005
1,1 Dichloroethane	mg/L	0	0.005
1,2 Dichloroethane	mg/L	0.005	0.0005
1,1 Dichloroethylene	mg/L	0.007	0.006
cis-1,2 Dichloroethylene	mg/L	0.07	0.006
trans-1,2 Dichloroethylene	mg/L	0.1	0.01
Dichloromethane	mg/L	0.005	0.005
1,3 Dichloropropane	mg/L	NR	0.0005
1,2 Dichloropropane	mg/L	0.005	0.005
Ethylbenzene	mg/L	0.7	0.3
Methyl-tert-butyl ether (MTBE)	mg/L	0	0.013
Monochlorobenzene	mg/L	0.1	0.07
Styrene	mg/L	0.1	0.1
1,1,2,2 Tetrachloroethane	mg/L	0	0.001
Tetrachloroethylene	mg/L	0.005	0.005
Toluene	mg/L	1	0.15
1,2,4 Trichlorobenzene	mg/L	0.07	0.07
1,1,1-Trichloroethane	mg/L	0.2	0.2
1,1,2-Trichloroethane	mg/L	0.005	0.005
Trichloroethylene	mg/L	0.005	0.005
Trichlorofluoromethane	mg/L	0	0.15
1,1,2,2-Trichloro-1,2,2-trifluoroethane	mg/L	0	1.2
Vinyl chloride	mg/L	0.002	0.0005
Xylenes	mg/L	10	1.75
SOCs			
Alachlor	mg/L	0.002	0.002
Atrazine	mg/L	0.003	0.001
Bentazon	mg/L	0	0.018
Benzo(a)pyrene	mg/L	0.0002	0.0002
Carbofuran	mg/L	0.04	0.018
Chlordane	mg/L	0.002	0.0001
Dalapon	mg/L	0.2	0.2
Dibromochloropropane	mg/L	0.0002	0.0002
Di(2ethylhexyl)adipate	mg/L	0.4	0.4
Di(2ethylhexyl)phthalate	mg/L	0.006	0.004
2,4-D	mg/L	0.07	0.07
Dinoseb	mg/L	0.007	0.007
Diquat	mg/L	0.02	0.02
Endothall	mg/L	0.1	0.1
Endrin	mg/L	0.002	0.002
Ethylene dibromide	mg/L	0.00005	0.00005
Glyphosate	mg/L	0.7	0.7
Heptachlor	mg/L	0.0004	0.00001
Heptachlor epoxide	mg/L	0.0002	0.00001
Hexachlorobenzene	mg/L	0.001	0.001
Hexachlorocyclopentadiene	mg/L	0.05	0.05
Lindane	mg/L	0.0002	0.0002
Methoxychlor	mg/L	0.04	0.03
Molinate	mg/L	0	0.02
Oxamyl (Vydate)	mg/L	0.2	0.05
Pentachlorophenol	mg/L	0.001	0.001
Picloram	mg/L	0.5	0.5
Polychlorinated Biphenyls	mg/L	0.0005	0.0005
Simazine	mg/L	0.004	0.004
Thiobencarb	mg/L	0	0.07
Toxaphene	mg/L	0.003	0.003
2,3,7,8-TCDD (Dioxin)	mg/L	3.00E-08	3exp-8
2,4,5-TP (Silvex)	mg/L	0.05	0.05
DBPs			
Total Trihalomethanes	mg/L	0.08	0.1
Total haloacetic acids	mg/L	0.06	0.06
Bromate	mg/L	0.01	0.01
Chlorite	mg/L	1	1

Table 9: Primary Drinking Water Standards for Measured Inorganic Parameters

Parameter	Units	Primary Drinking Water Standard, MCL	
		Federal	CA
<i>Inorganics</i>			
Antimony	mg/L	0.006	0.006
Arsenic	mg/L	0.01	0.01
Asbestos	MFL/L	7	7
Barium	mg/L	2	1
Beryllium	mg/L	0.004	0.004
Cadmium	mg/L	0.005	0.005
Chromium	mg/L	0.1	0.05
Copper	mg/L	1.3	1.3
Cyanide	mg/L	0.2	0.2
Fluoride	mg/L	4	2
Lead	mg/L	0.015	0.015
Mercury	mg/L	0.002	0.002
Nickel	mg/L	0	0.1
Nitrate	mg/L	10 (as N)	45 (as NO ₃)
Nitrite as N	mg/L	1	1
Selenium	mg/L	0.05	0.05
Thallium	mg/L	0.002	0.002
<i>Microbial</i>			
Total Coliforms	P/A	Absent	Absent
<i>Radionuclides</i>			
Uranium	ug/L	30	0
Uranium	pCi/L	0	20
Radium 226+228	pCi/L	5	5
Gross Alpha Part.	pCi/L	15	15
Gross Beta Part.	mrem/yr	4	0
Gross Beta Part.	pCi/L	0	50
Strontium 90	pCi/L	8	8
Tritium	pCi/L	20000	20000

Table 10: Secondary Drinking Water Standards for Measured Parameters

Parameter	Units	Secondary, MCL	
		Federal	CA
Aluminum	mg/L	0.2	0.2
Color	Units	15	15
Copper	mg/L	1	1
Corrosivity		Non Corr.	Non Corr.
Foaming Agents (MBAS)	mg/L	0.5	0.5
Iron	mg/L	0.3	0.3
Manganese	mg/L	0.05	0.05
MTBE	mg/L	NR	0.005
Odor Threshold	TON	3	3
Silver	mg/L	0.1	0.1
Thiobencarb	mg/L	NR	0.001
Turbidity	NTU	5	5
Zinc	mg/L	5	5
pH		6.5-8.5	NR
Specific Conductance	micromhos	NR	900
Sulfate	mg/L	250	250
Fluoride	mg/L	2	NR
Chloride	mg/L	250	250
TDS	mg/L	500	500

Table 11: CDHS Drinking Water Notification Levels for 21 Compounds

Notes*	Chemical	Notification Level(milligrams per liter)
1	Boron	1
2	n-Butylbenzene	0.26
3	sec-Butylbenzene	0.26
4	tert-Butylbenzene	0.26
5	2-Chlorotoluene	0.14
6	4-Chlorotoluene	0.14
7	Dichlorodifluoromethane (Freon 12)	1
8	1,4-Dioxane	0.003
9	Isopropylbenzene	0.77
10	Manganese**	0.5
11	Methyl isobutyl ketone (MIBK)	0.12
12	Naphthalene	0.017
13	N-Nitrosodimethylamine (NDMA)	0.00001
14	Perchlorate	0.006
15	Propachlor	0.09
16	n-Propylbenzene	0.26
17	Tertiary butyl alcohol (TBA)	0.012
18	1,2,3-Trichloropropane (1,2,3-TCP)	0.000005
19	1,2,4-Trimethylbenzene	0.33
20	1,3,5-Trimethylbenzene	0.33
21	Vanadium	0.05
<p>Information obtained from http://www.dhs.ca.gov/ps/ddwem/chemicals/AL/notificationlevels.htm Last Updated Sept. 30, 2005, for complete list of current notifications levels visit the CDHS website listed above.</p>		

Table 12: EDC and PPCP Spiking Experiment Results (w/hydrogen peroxide)

Compounds	Run #1 Influent (ppt)	Run #2 Influent (ppt)	Run #3 Influent (ppt)	Run #1 Effluent (ppt)	Run #2 Effluent (ppt)	Run #3 Effluent (ppt)	Run #1 Log Removal	Run #2 Log Removal	Run #3 Log Removal
Caffeine	659	674	827	<10	<10	<10	>1.82	>1.83	>1.92
TCEP	731	716	897	467	511	530	0.19	0.15	0.23
DEET	630	659	755	4.0	3.4	3.4	2.20	2.29	2.35
Oxybenzone	276	337	370	<1.0	<1.0	<1.0	>2.44	>2.53	>2.57
Estrone	80	84	104	<1.0	<1.0	<1.0	>1.9	>1.92	>2.02
Iopromide	579	620	740	5.6	5.5	4.7	2.01	2.05	2.20
Ibuprofen	684	682	813	1.8	2.0	2.4	2.58	2.53	2.53
Triclosan	321	345	411	1.7	1.1	1.8	2.28	2.50	2.36

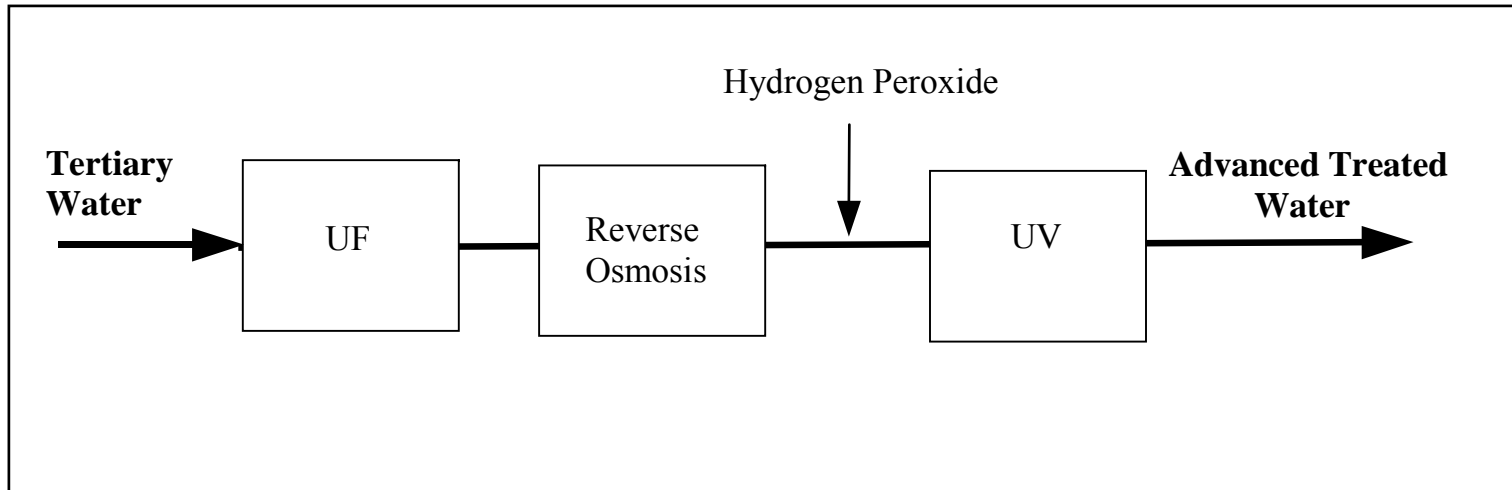

Figure 1: Schematic Diagram of the Advanced Water Treatment Train (Proposed 2005)

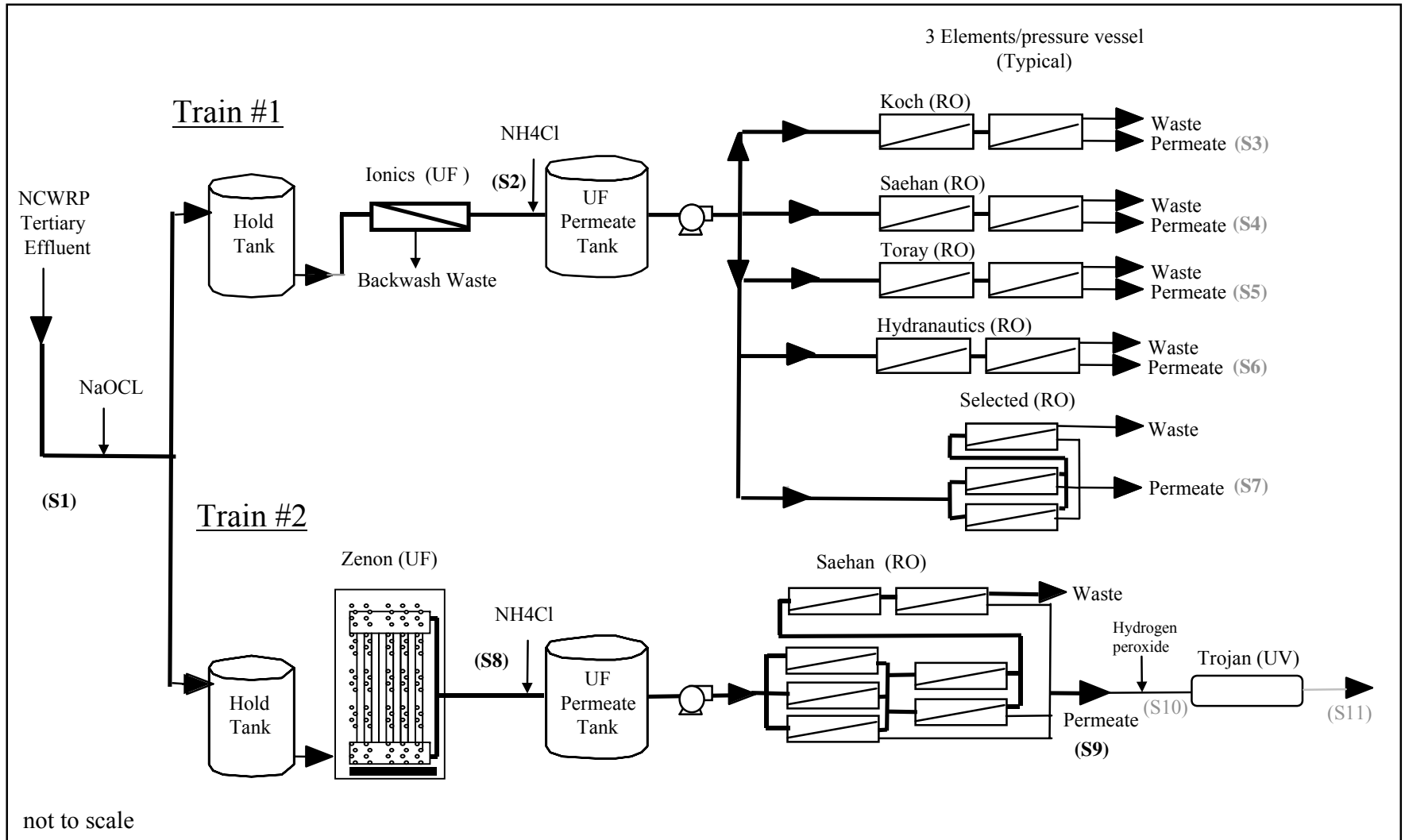

Figure 2: Schematic of the Water Reuse Study Pilot Plant Layout

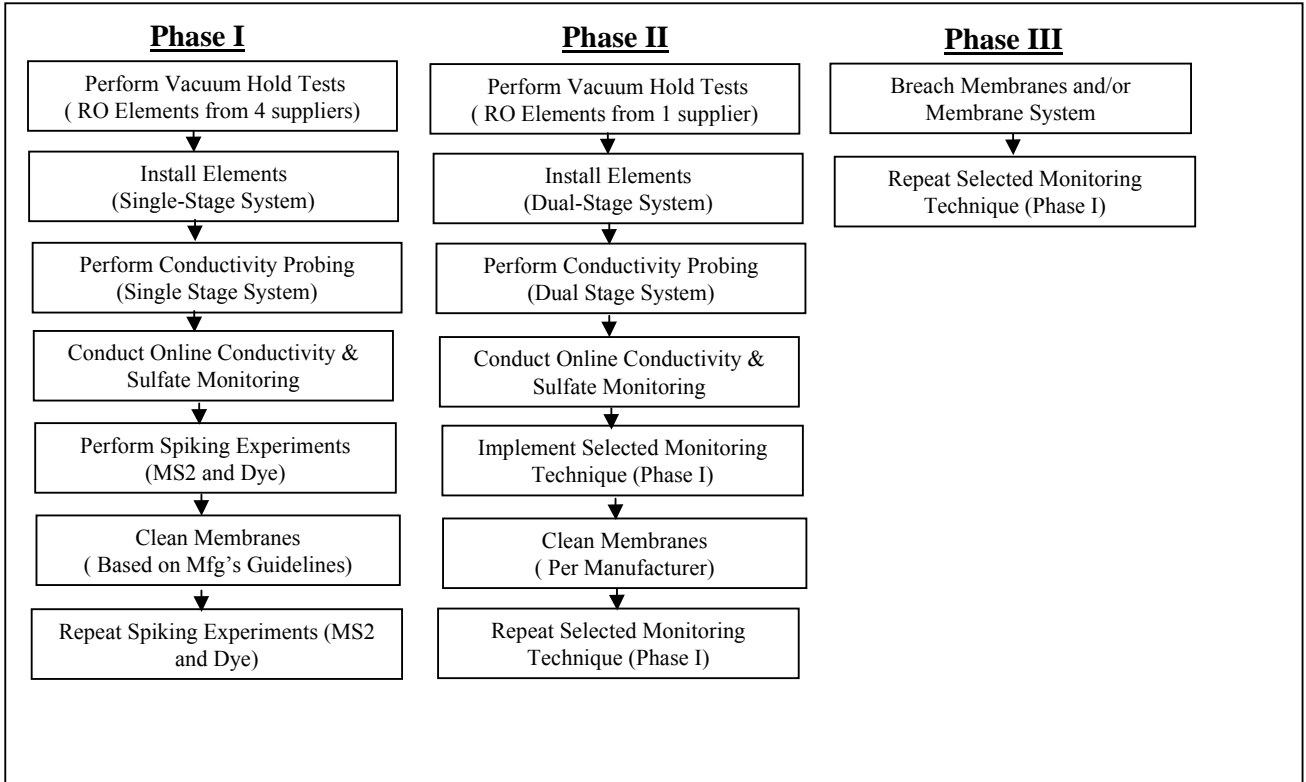

Figure 3: RO Integrity Monitoring Plan

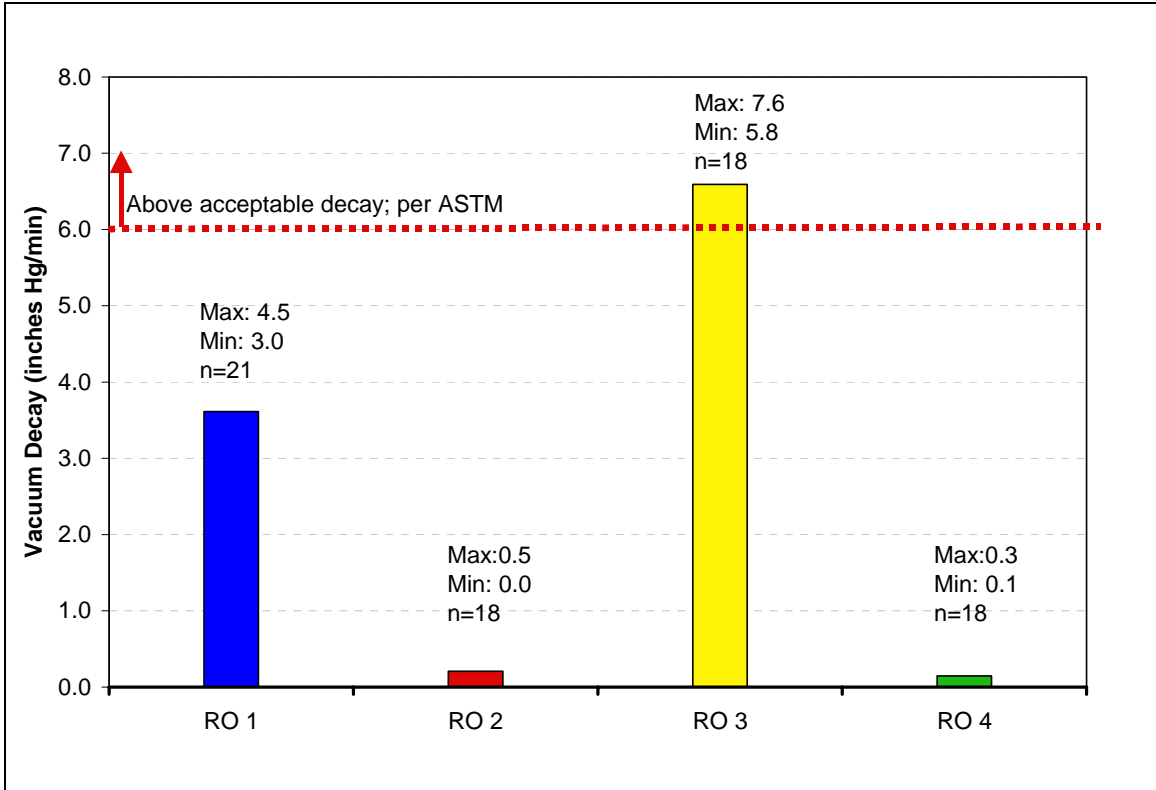

Figure 4: Vacuum Decay Test Results of RO Membranes from Various Suppliers

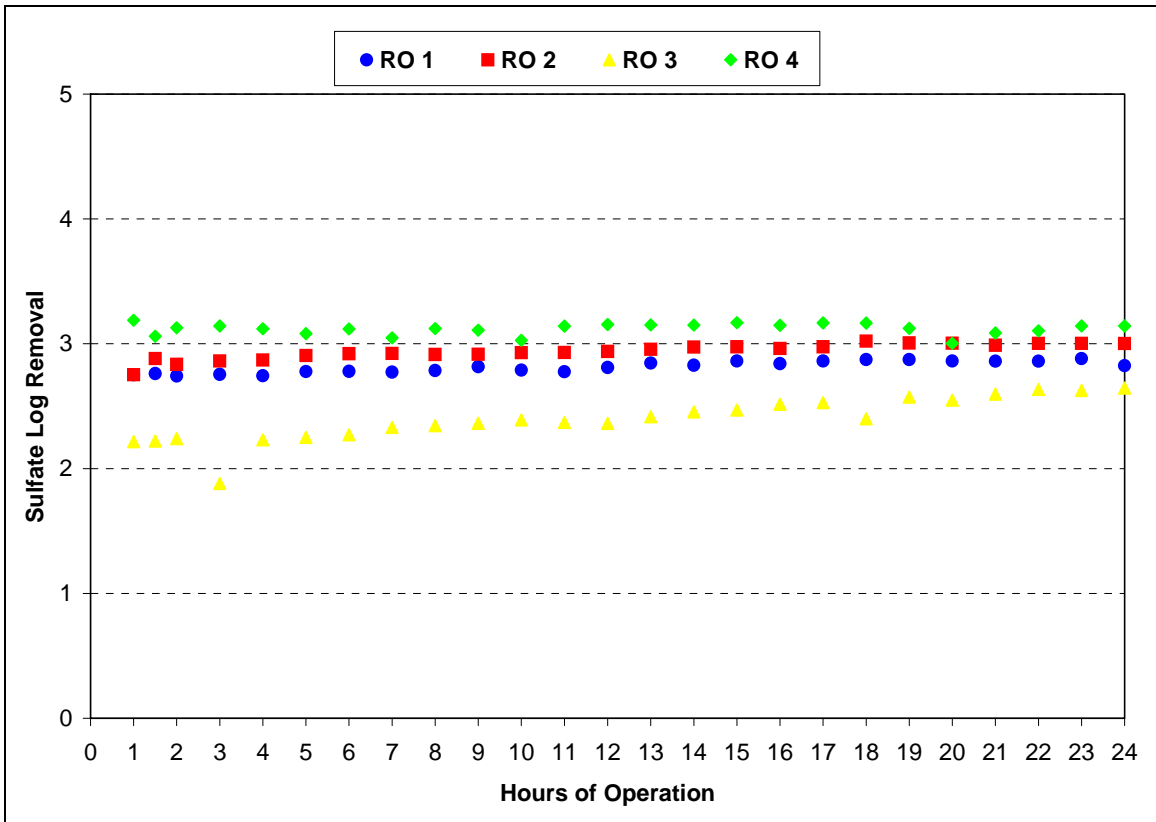

Figure 5: Sulfate Rejection Results of RO Membranes from Various Suppliers

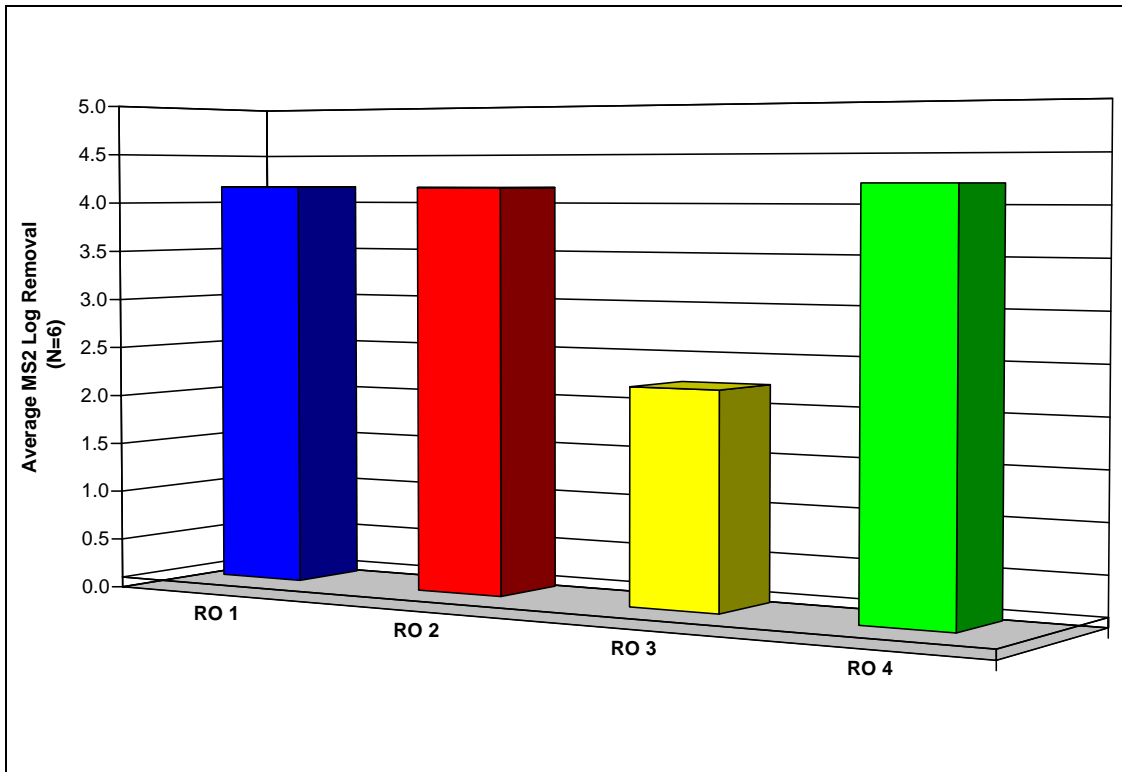

Figure 6: MS2 Phage Seeding Experiment Results from Various Suppliers

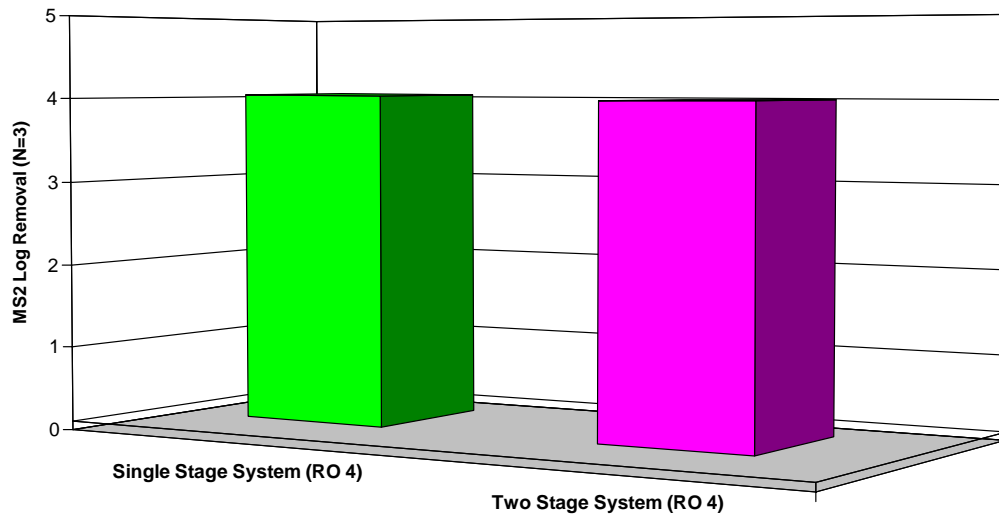

Figure 7: MS2 Phage Seeding Experiment Results Single VS. Two Stage System

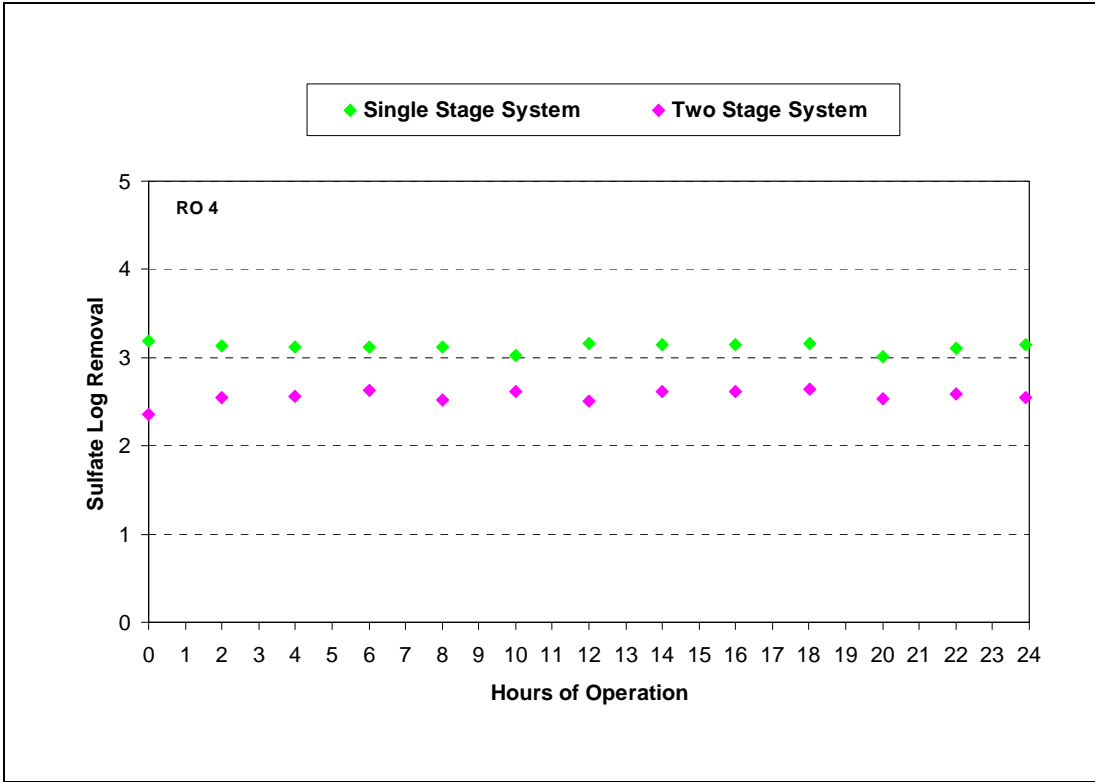

Figure 8: Sulfate Rejection Results Single Stage VS. Two Stage System

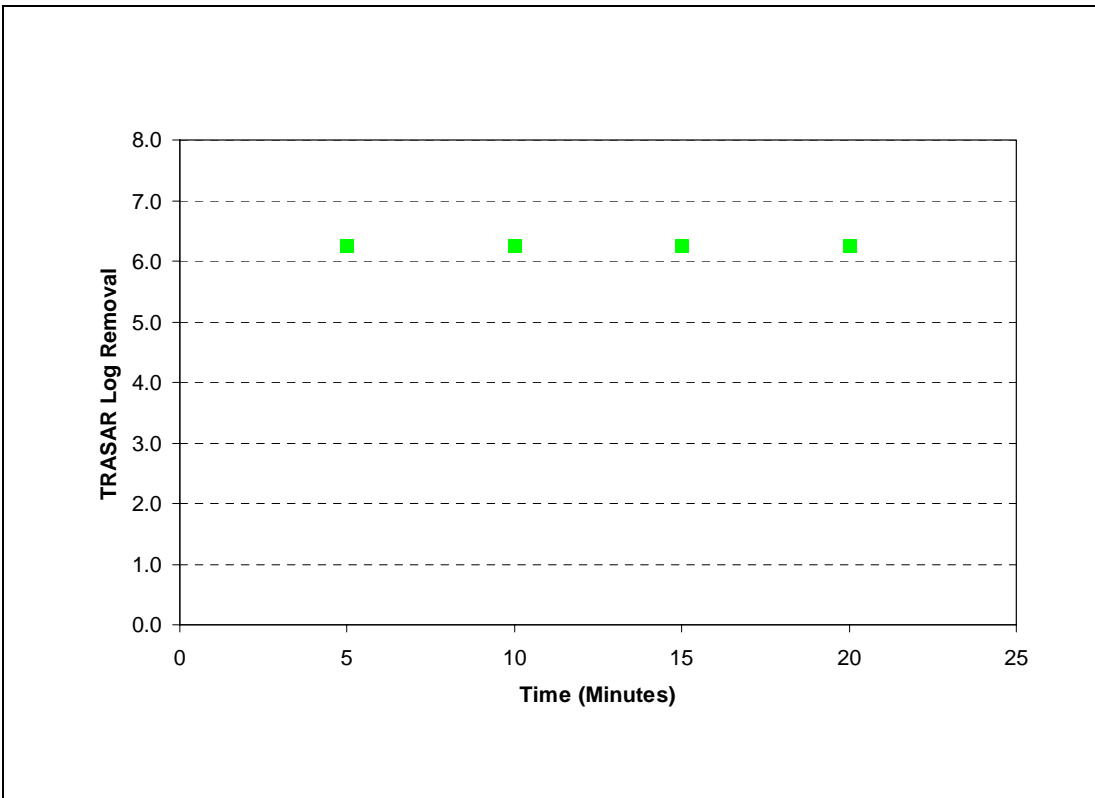

Figure 9: TRASAR Rejection Results

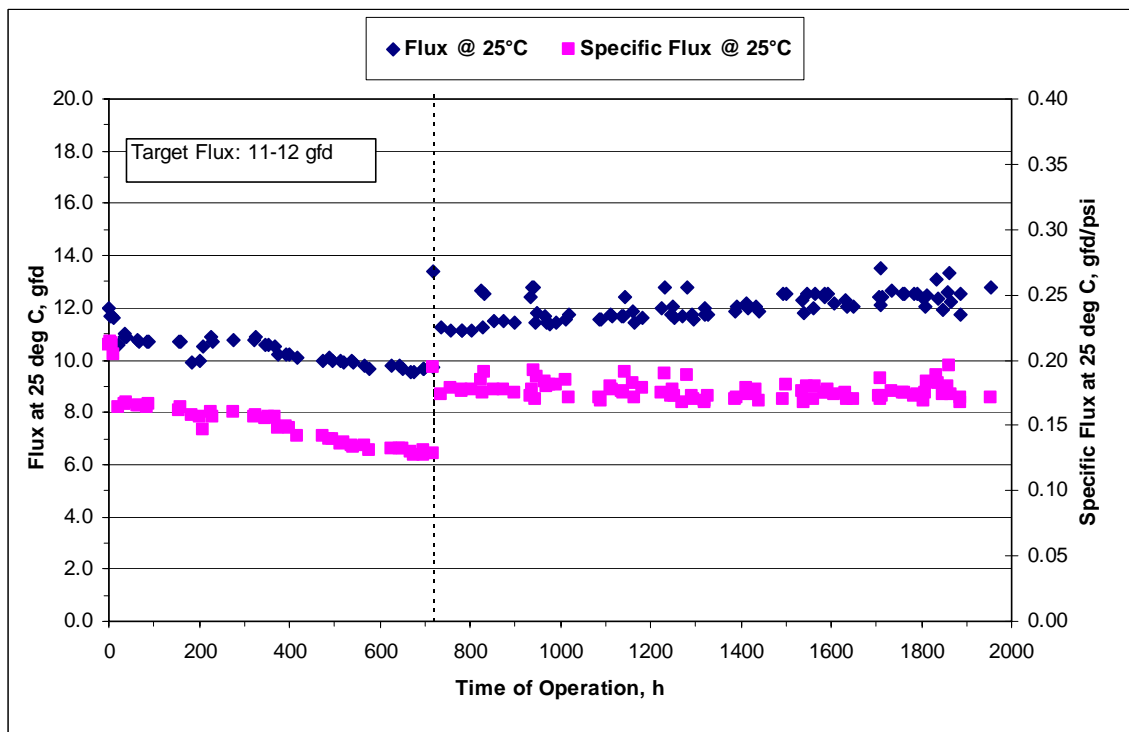
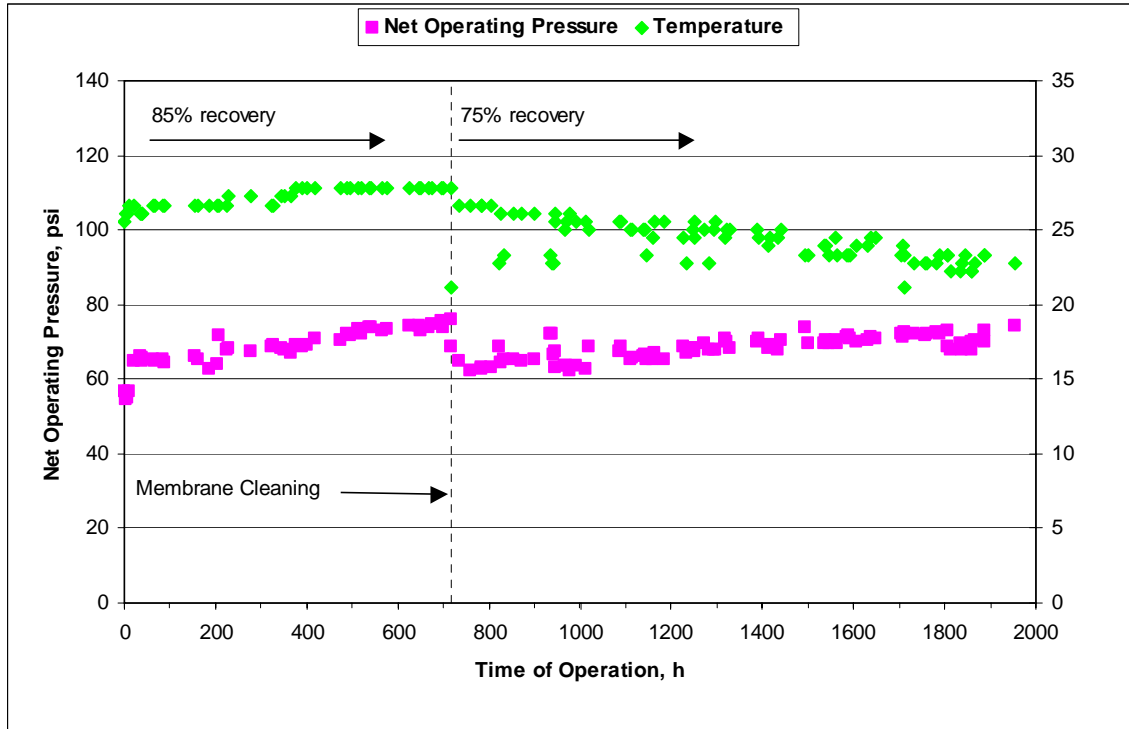

Figure 10: RO Membrane Performance (Saehan 4040 BLR)

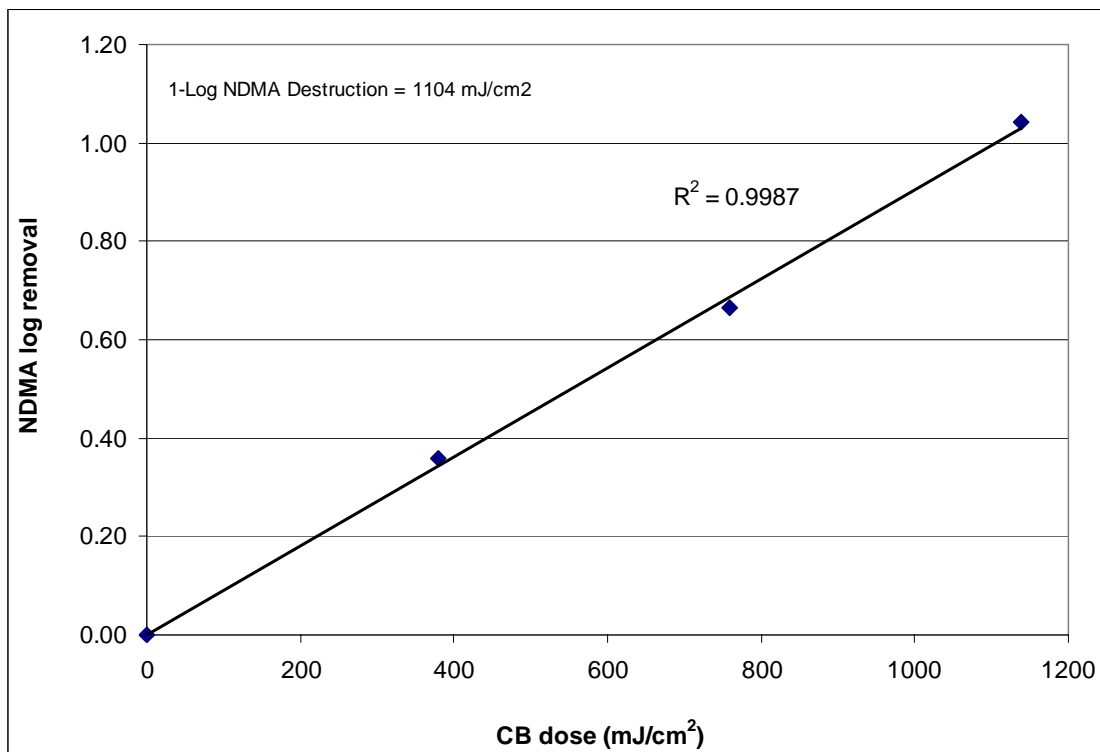

Figure 11: Results from UV Collimated Beam Testing for NDMA Destruction

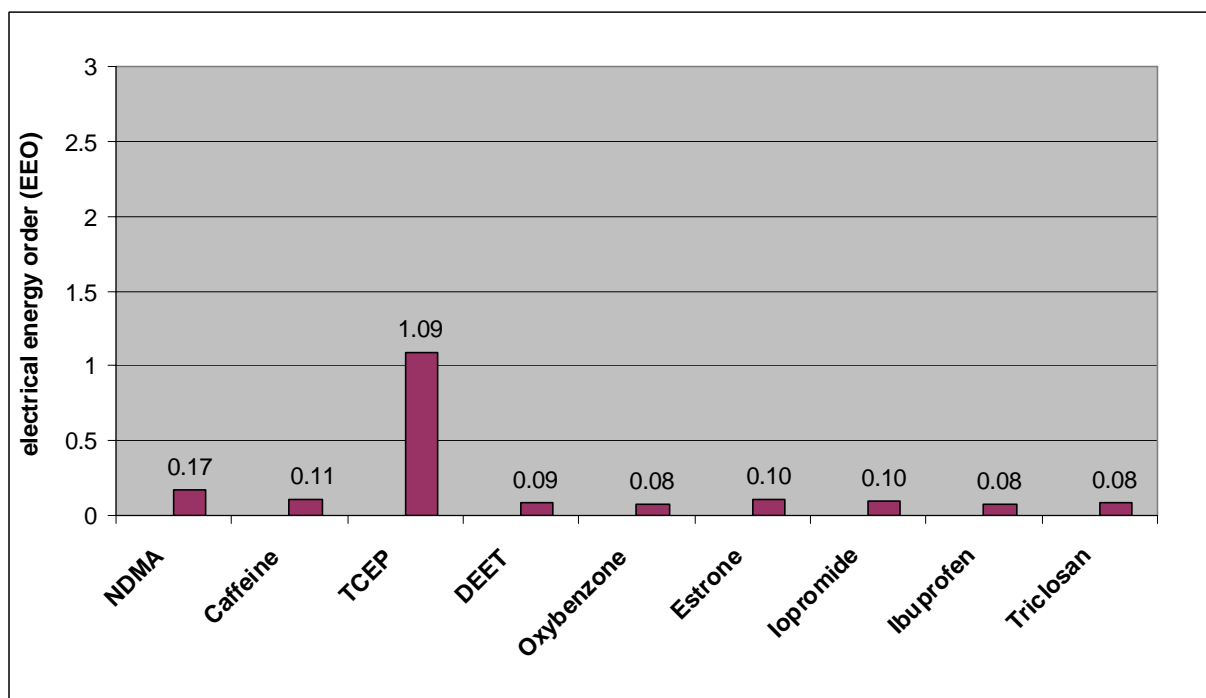

Figure 12: EEO values of the spiked NDMA, EDC and PPCPs Treated with UV/Peroxide

DRAFT

**APPENDIX A: CORRESPONDENCE FROM THE
CITY OF SAN DIEGO WATER QUALITY LABORATORY**

City of San Diego
Water Quality Laboratory
5530 Kiowa Drive
La Mesa, CA 91942

January 24, 2006

James DeCarolis
Engineer
Aqua 2030 Research Center
North City Water Reclamation Plant
4949 Eastgate Mall
San Diego, CA 92121

Dear Sir:

The City of San Diego's, Water Quality Laboratory performed analysis on samples from the North City Water Reclamation Plant research projects. The samples were analyzed for organic and inorganic compounds and collected from December 2004 through December 2005.

The inorganic compounds were selected by the project managers and consisted of metals, anions, cations, hardness, silica, and physical parameters. The inorganic analysis provided a general evaluation of the effectiveness of the treatment process, levels of compounds of concern with Reverse Osmosis processes, and trace metal concentrations.

Organic analysis selection was based upon State of California Title 22 Drinking Water standard. The method detection levels were at or below the State of California, Detection Level for Reporting values. The compounds included a wide range of herbicides, pesticides, semi-volatile, and volatile analytes.

Sincerely,

Dana Chapin
Senior Chemist
Water Quality Laboratory

DRAFT

**APPENDIX B: CORRESPONDENCE FROM
MWH LABORATORIES**



A Division of MWH Americas, Inc.

750 Royal Oaks Drive, Suite 100
Monrovia, California 91016-3629
Tel: 626 386 1100
Fax: 626 386 1101
1 800 566 LABS (1 800 566 5227)

January 23, 2006

James DeCarolis
Applied Research MWA
North City Water Rec Plant
4949 Eastgate Mall
San Diego, CA 92121

Reference report #163404- 412-415

Dear James;

MWH Labs and our subcontractor, Pace Analytical Services tested a wide variety of compounds for the subject project on 3 samples, RO Feed, UV Influent, and UV Effluent. Below we have summarized the various classes of constituents that were tested, along with some information about regulatory status and occurrence for each group..

General Physical (Color, Odor, Turbidity) are all secondary drinking water standards and are based on aesthetic considerations.

Total and Fecal Coliform have primary drinking water standards and reflect the presence or absence of naturally occurring and human/animal waste derived bacteria.

Volatile organic compounds by method 524.2 include both regulated and unregulated compounds (solvents from industrial chemical processes, petroleum products, etc). Many of these are common groundwater contaminants in industrialized areas. All of these target compounds are analyzed by the same method and therefore additional information is available beyond the regulated compounds only.

EDB and DBCP, tested by EPA Method 504.1, are fumigants and industrial chemicals that have primary drinking water standards. Both commonly occur in groundwaters throughout much of California.

Chlorinated Pesticides, tested by EPA Method 505, have primary drinking water standards for many of the compounds and some occur in agricultural runoff. Like the volatile organics, there are additional compounds that are not regulated that are recovered by the same analytical method, providing extra information at no extra cost.

Chlorinated acid herbicides, tested by EPA Method 515.4, have primary drinking water standards for many of the compounds and some occur in agricultural or domestic runoff. Like the volatile organics, there are additional compounds that are not regulated that are recovered by the same analytical method, providing extra information at no cost.

DRAFT

Synthetic Organic Compounds and Pesticides, tested by EPA Method 525.2, have primary drinking water standards for many of the compounds and some occur in agricultural or domestic runoff. Like the volatile organics, there are additional compounds that are not regulated that are recovered by the same analytical method, providing extra information at no extra cost. Some of the compounds in this list are the same compounds found in the 505 list, providing extra confirmation of any detects.

Carbamate pesticides, tested by EPA method 531.2, includes several compounds that have primary drinking water standards, and many others that are recovered by the same analytical method.. These pesticides are typically found in agricultural runoff.

2,3,7,8-TCDD (Dioxin) was tested by a subcontractor using method 1613. This compound is a byproduct of incomplete incineration of chlorinated solvents and is also sometimes present in industrial discharges. It has a very low primary drinking water standard due to it's toxicity.

Endothall, tested by EPA Method 548.1, is a herbicide sometimes found in agricultural runoff, that has a primary drinking water standard.

Glyphosate, tested by EPA Method 547, is a herbicide often used on rice fields. It has a primary drinking water standard.

Diquat and Paraquat, tested by EPA method 549.2, are herbicides used in agricultural areas. Diquat has a primary drinking water standard.

N-nitrosodimethylamine (NDMA), tested by modified EPA Method 1625, is considered a highly toxic organic compound. It is found in rocket fuels, due to it's use in the production of dimethylhydrazine, and is also found as an industrial solvent and as a disinfection byproduct. The State of California currently has a 10 part per trillion (ppt) Notification Level for NDMA and the USEPA has included it in the next round of unregulated contaminant monitoring.

Cyanide, tested by Standard Methods 4500-CN-F, has a primary drinking water standard. It is an inorganic chemical found in discharges from various industrial processes.

Asbestos, tested by EPA method 100.2, has a primary drinking water standard. It occurs naturally in serpentine rocks throughout California and may also occur as a result of decay of asbestos cement pipe in water mains.

Gross Alpha and Beta Radioactivity, tested by EPA Method 900.0, have primary drinking water standards and most often occur as a result of erosion of deposits that contain naturally occurring radionuclides and then emit radiation. They may also occur due to manmade nuclides.

Radium 228, tested by Pace Analytical Services using EPA Method 904.0, is a beta emitting radionuclide that is typically naturally occurring as a result of erosion of deposits containing radium. It has a primary drinking water standard.

Dioxane, tested by EPA Method 8270, is an industrial solvent/degreasing agent that is an emerging contaminant in many parts of the country and has been found in groundwater in different parts of California.

Perchlorate, tested by EPA Method 314, is primarily a component of rocket fuel, but has also been found in flares, fireworks, and other miscellaneous sources. It is found in groundwater and surface water in many parts of California and numerous other states. California currently has a 6 ppb public health goal for perchlorate, and at least one state, Massachusetts, is considering regulating it at an even lower level.

Metals and Inorganics, many regulated as primary and secondary drinking water standards were tested by a variety of EPA and Standard Methods techniques. Many of these compounds/elements primarily occur naturally in the environment (e.g. arsenic), while others may mainly occur as a result of industrial discharges from mining or various other industries.

The table below represents some unusual or significant results. In all cases where there were detects in the RO Feed, there are significant decreases through the RO and into the UV Influent and UV Effluent. There is one case, noted in the table for TDS, where there appears to be an increase in the UV Effluent vs the UV influent, but this may be an analytical artifact. There were numerous metals and some pesticides in the RO Feed sample. With the exception of the items below (Dioxane and NDMA), none of the other contaminants passed through the RO.

Compound	RO Feed	UV Influent	UV Effluent	Comment
Dioxane	71	4.7	2.8	Significant reduction through RO, some further through UV
NDMA	18	12	2.3	UV effective at treatment
TDS	1040	10	48	This could be a sampling or analytical artifact; one would not normally expect an increase in TDS following treatment; note that the specific conductance does not show this same trend.
Conductivity	1820	44	43	TDS pattern should be similar, but may reflect artifacts.

If you have any questions, do not hesitate to contact us.

Sincerely yours,



Andrew Eaton, Ph.D.
Laboratory Director

DRAFT

**APPENDIX C: CORRESPONDENCE FROM THE
SOUTHERN NEVADA WATER AUTHORITY RESEARCH LABORATORY**

DRAFT

SAN DIEGO WATER RECLAMATION PROJECT

Endocrine Disruptor and Pharmaceutical Component

FINAL REPORT

13th February 2006

Dr. Shane Snyder
1402 Pueblo Drive
Boulder City, NV 89005
(702) 743-9674
snyders22@cox.net

INTRODUCTION:

Certain hormonally active chemicals, known as endocrine disrupting chemicals (EDCs), are known to mimic or block natural hormones in animals. The U.S. Environmental Protection Agency (EPA) defines environmental EDCs as xenobiotics (agents foreign to an organism) that interfere with the “synthesis, secretion, transport, binding, action, or elimination of natural hormones in the body that are responsible for the maintenance of homeostasis, reproduction, development, and/or behavior” (EPA 1997).

The discovery that certain compounds can mimic the natural hormones of animals was reported as early as the 1930s (Walker and Janney 1930; Cook, Dodds et al. 1934; Stroud 1940; Schueler 1946; Sluczewski and Roth 1948). However, the estrogenic activity of synthetic organic compounds was of little interest to the environmental community until several decades later when the pesticide DDT was implicated as the cause of deformed sex organs and skewed sex ratios in gulls living in contaminated areas (Fry and Toone 1981; Fry, Toone et al. 1987). Additional studies have demonstrated that endocrine disruption in a wide variety of wildlife species, including marine gastropods, frogs, fish, and alligators, is associated with exposure to synthetic chemicals such as pesticides, steroids, surfactants, and plasticizers (Snyder, Westerhoff et al. 2003; Snyder, Pleus et al. 2005).

Endocrine disruption also can be caused by naturally occurring chemicals. Estrogens from plant sources, known as phytoestrogens, have been linked to reproductive failures in animals, such as sheep that graze on certain strains of clover (Brookbanks, Welch et al. 1969; Setchell, Gosselin et al. 1987; Gavaler, Rosenblum et al. 1995). Various over-the-counter medicinal supplements, such as those recommended for estrogen replacement therapy in post-menopausal women, contain high levels of phytoestrogens (Burton and Wells 2002; Shaw and McCully 2002; Wanibuchi, Kang et al. 2003; Wutte, Jarry et al. 2003). Industrial activities such as pulp and paper production also can release large quantities of phytoestrogens that may impact reproductive system function in fish (Tremblay and Van Der Kraak 1999). The degradation of vegetable matter and paper products in wastewater treatment plants (WWTPs) also may contribute to releases of phytoestrogens into the aquatic ecosystem.

Initial attempts to identify the cause of feminization of fish exposed to sewage treatment plant effluents focused on synthetic organic chemicals with known estrogenic effects, such as plasticizers and surfactant degradation products (Bevans, Goodbred et al. 1996; Folmar, Denslow et al. 1996; Harries, Sheahan et al. 1996; Nimrod and Benson 1996). However, recent research suggests that natural estrogens and a common synthetic birth control pharmaceutical, ethinylestradiol, are the most potent estrogens in sewage effluent (Desbrow, Routledge et al. 1998; Snyder, Keith et al. 1999; Snyder, Snyder et al. 2000; Snyder, Kelly et al. 2001; Snyder, Villeneuve et al. 2001). In fact, researchers have demonstrated that ethinylestradiol can induce endocrine disruptive effects in fish at concentrations present in some municipal sewage effluents (Majewski, Blanchfield et al. 2002; van Aerle, Pounds et al. 2002; Van den Belt, Verheyen et al. 2003).

While pharmaceuticals were reported in US waters as early as the 1970s, the issue remained relatively dormant until the link between the pharmaceutical ethinylestradiol and biomarker changes in fish was established (Garrison, Pope et al. 1975; Hignite and Azarnoff 1977; Tabak, Bloomhuff et al. 1981). Since this discovery, a plethora of reports have surfaced showing that pharmaceuticals are ubiquitous contaminants of wastewater effluents at trace (i.e., ng/L) concentrations. The determination of toxicological relevance and cost-effective treatment options are emerging research topics and subjects of debate throughout the world.

SAN DIEGO TREATMENT PROJECT-2006 UPDATE

I was requested to act as a consultant to MWH in the capacity of assisting the MWH team with a series of experiments related to the evaluation of various advanced treatment systems for the removal of EDCs and pharmaceuticals. Samples were to be analyzed by the Southern Nevada Water Authority (SNWA) R&D Division in Henderson, Nevada.

The initial step in this portion of the project involved the selection of target compounds. I suggested that MWH consider using a select group of compounds that have been analyzed previously by SNWA and for which the method has been peer-reviewed and published in the journal *Analytical Chemistry* in 2003 (Vanderford, Pearson et al. 2003). Table 1 shows the compounds selected for analysis in this project. These compounds were chosen based on three primary criteria: 1) likelihood of occurrence based on past US monitoring results, 2) a wide variety of physical-chemical properties (e.g., molecular size, volatility, polarity, and acid/base/neutral functionalities, and 3) the ability to analyze using a single solid-phase extraction followed by GC/MS/MS and/or LC/MS/MS (Figure 1). In the method developed by my group at SNWA, GC/MS/MS compounds were essentially legacy contaminants, such as DDT, Lindane, PAHs, etc. These compounds were rarely detected in any of our studies and add significant cost and complexity to the analyses. Therefore, I suggested we focus only on the LC/MS/MS compounds, which are essentially the target EDCs and pharmaceuticals (Table 1).

In the initial report submitted in May 2005, high levels of triclosan, a prevalent antimicrobial used in a common household products, was found in many samples and blanks due to contamination during sample processing. Concentrations of triclosan in samples and blanks were often as high as 200 ng/L. This contamination was found in all samples processed at SNWA during this time frame, including those from the San Diego membrane/AOP project. SNWA immediately replaced all chemicals that come into contact with samples (e.g., sodium azide and ascorbic acid) and began testing to find the source of the triclosan contamination. Interestingly, the exact cause was not determined since old stocks of ascorbic acid and sodium azide (sample preservative) were discarded prior to testing. Likewise, since replacement of these stocks, the triclosan contamination has been alleviated. Since the previous report, samples from the RO-UV/AOP spiking study have been completed and are updated in Tables 11 and 12. Four additional sampling events took place using the RO pilot skid: August 16th, August 30th, September 20th, and December 30th 2005. Results from these events are shown in Tables 13 through 16. Triclosan contamination was not an issue in these sampling events.

Figure 1. Analytical Method Used by SNWA for EDCs and Pharmaceuticals

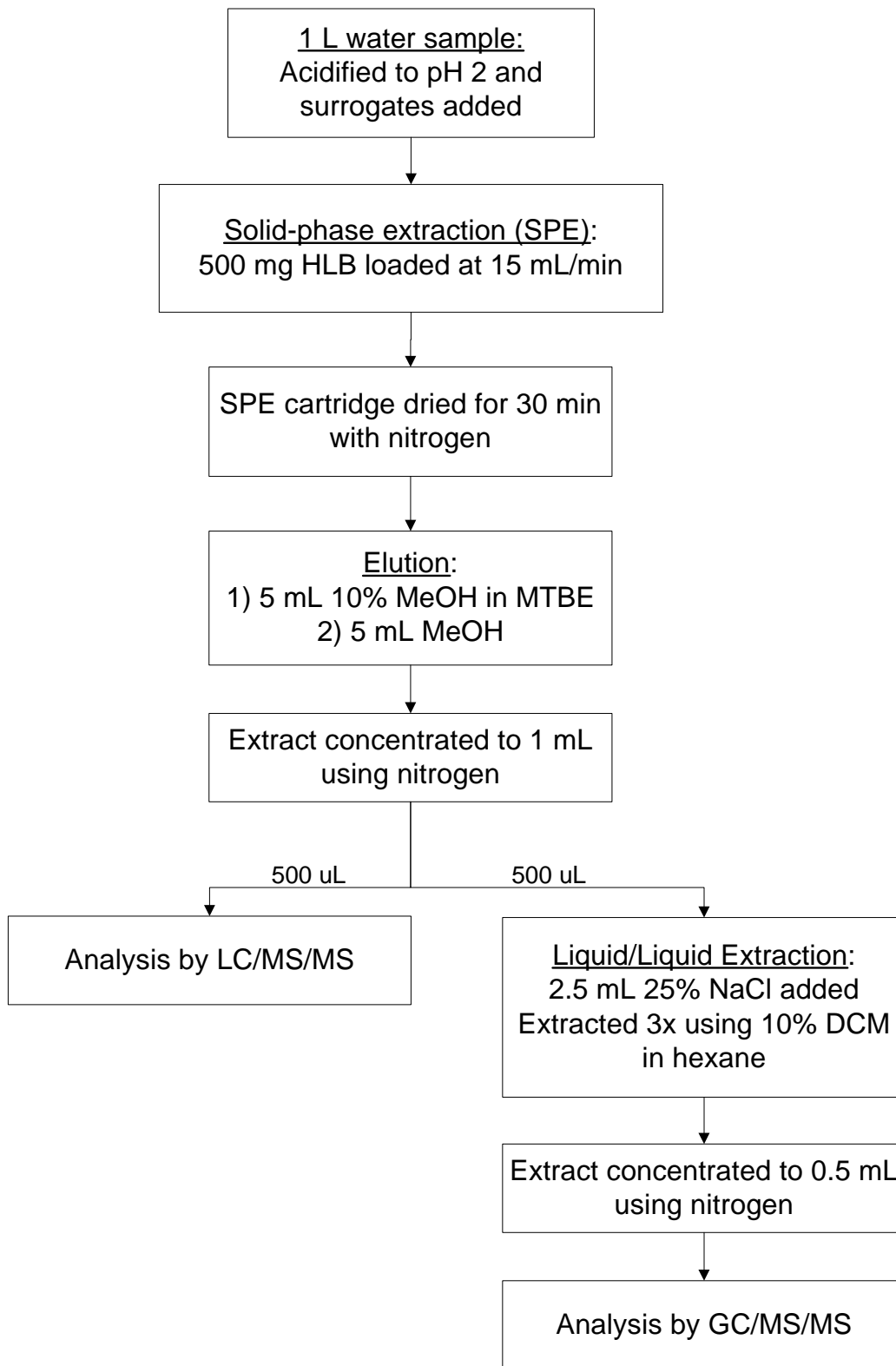
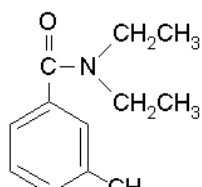
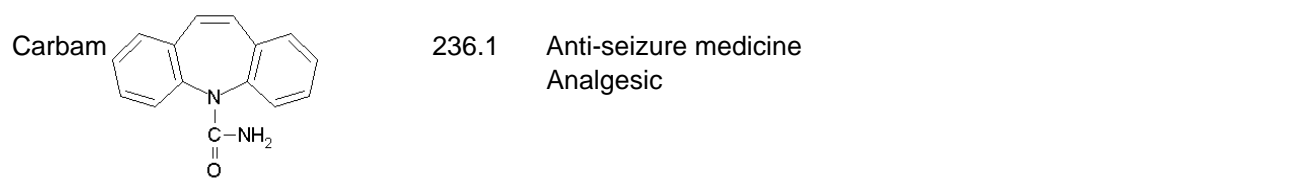
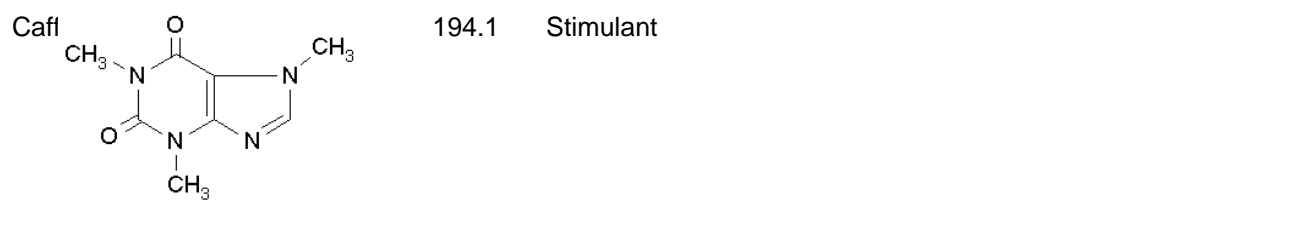
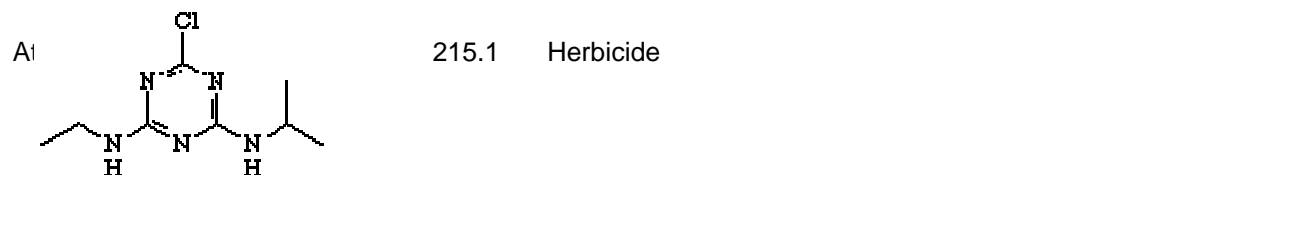
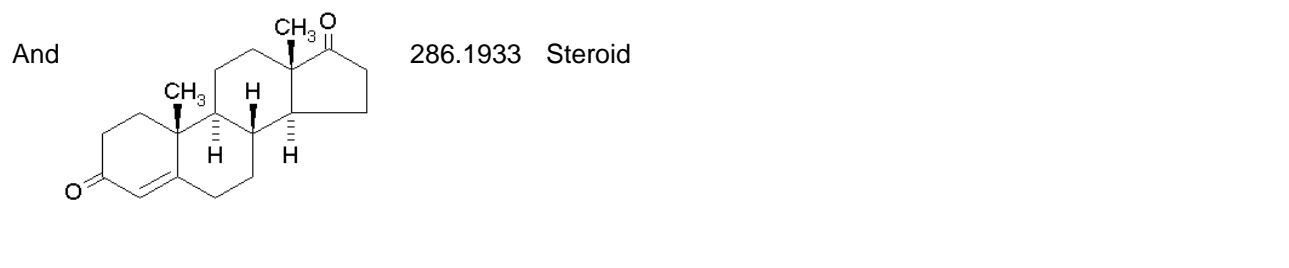
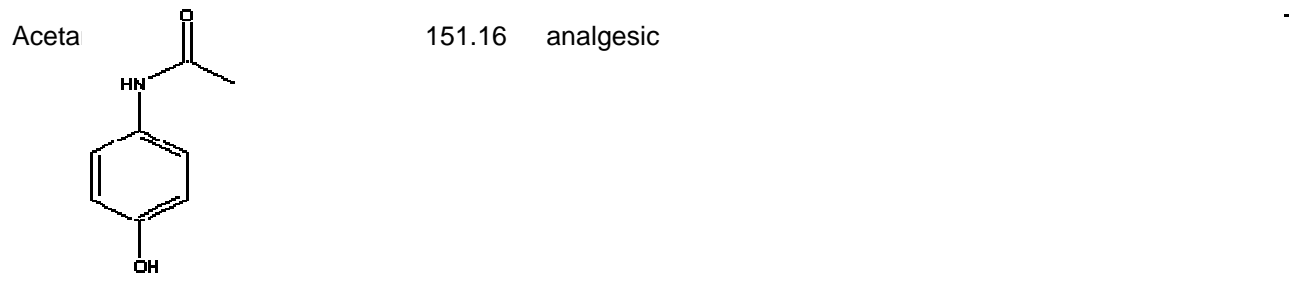

Table 1. Target Compounds

<u>Name</u>	<u>MW</u>	<u>Use</u>	<u>Structure</u>
-------------	-----------	------------	------------------



DEET

191.13 Mosquito Repellant

Diazepam

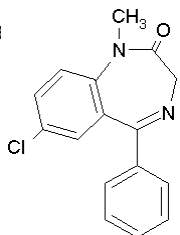

284.1 Muscle relaxant
Trade name Valium
Anti-anxiety

Diclofen

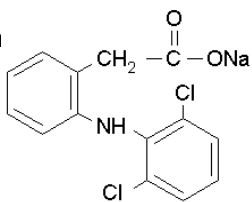

294.01 Treatment for arthritis
317
(salt)

Dilant

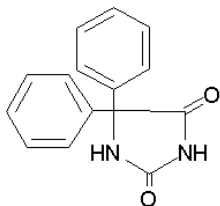

252.09 Anti-convulsant

Est

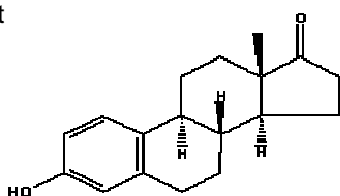

270.37 Steroid

Est

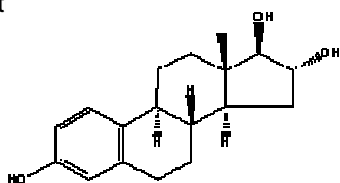

288.39 Steroid

Et

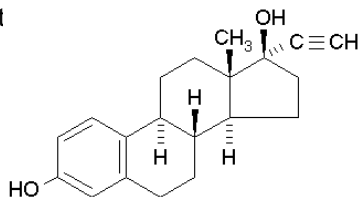

296.18 Synthetic birth control

Ery
(Ar

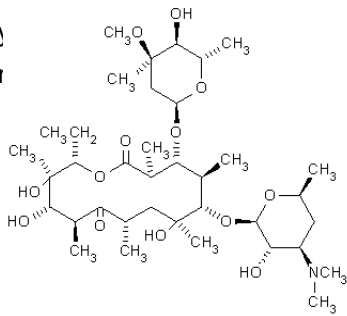

733.46 Anti-biotic
(715)

17β-E

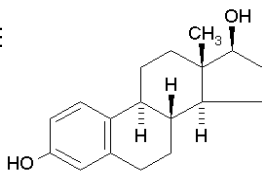

272.1776 Steroid

Fluoxetine

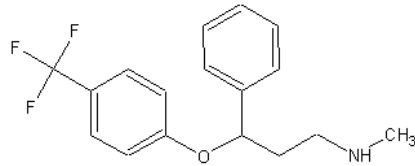

Gemfibrozil
(Lopid)

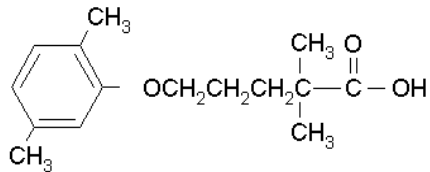

Hyc
(l

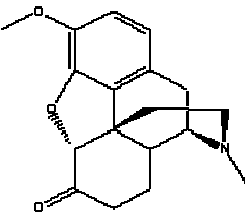

299.37 Pain killer

Ibuprofen

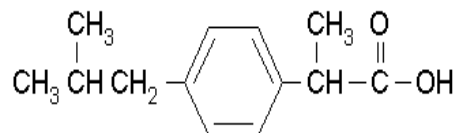

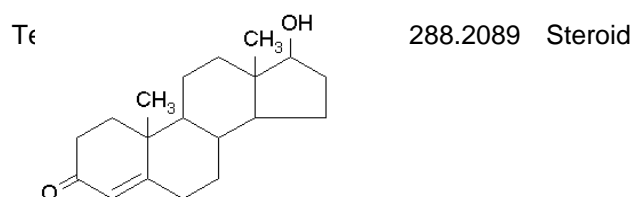
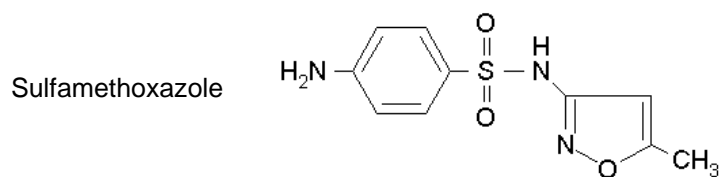
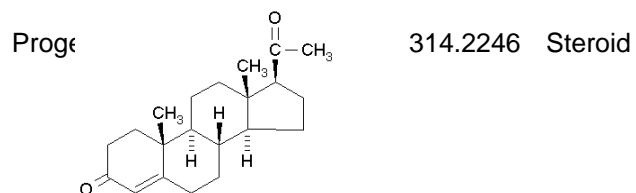
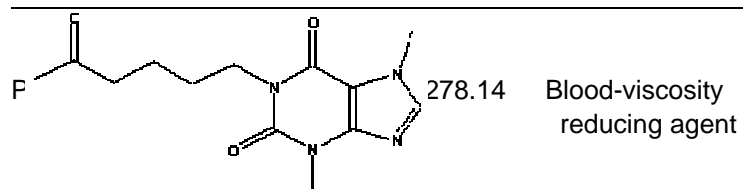
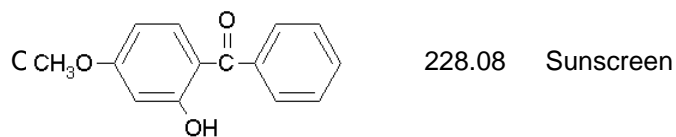
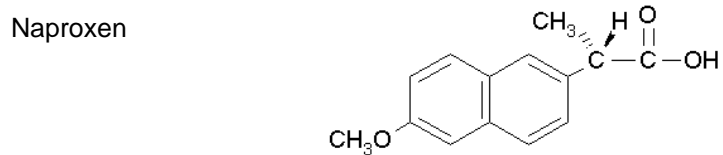
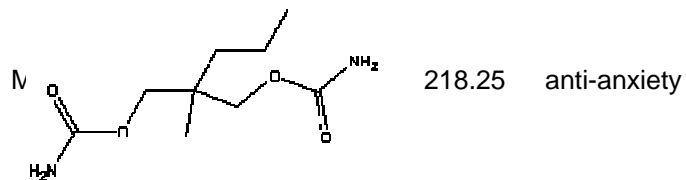
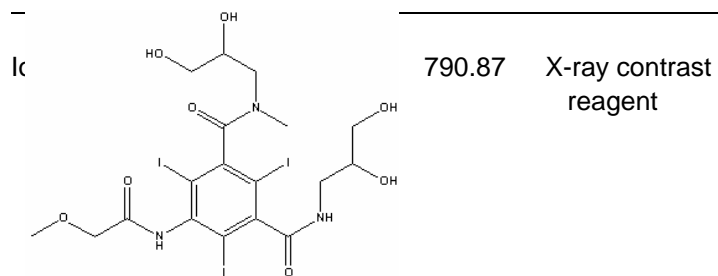

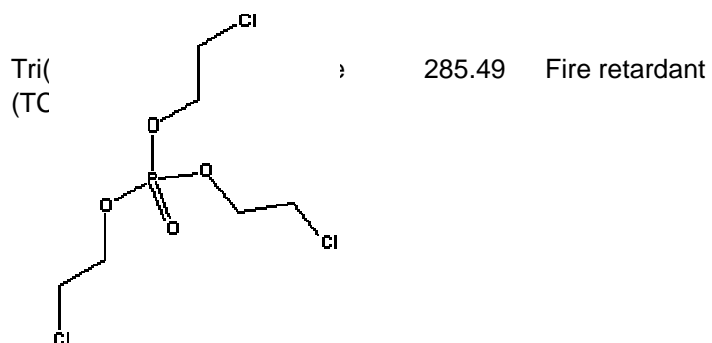
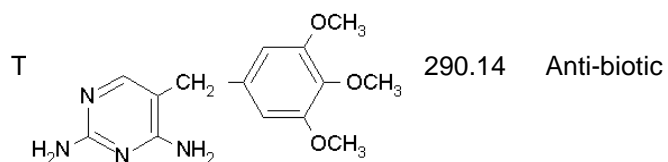
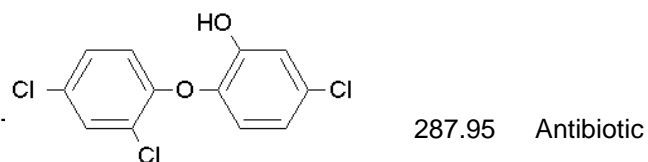

The group of compounds shown in Table 1 represents some of the most widely detected EDCs, pharmaceuticals, and personal care products occurring in US wastewater effluents. Likewise, these compounds can be analyzed using the robust and highly sensitive LC/MS/MS method described previously.

Target Compounds for Spiking Study. Spiking studies are highly recommended for evaluation of pilot-scale systems. Since unspiked evaluations must rely on the detection of trace contaminants within the influent water, these detections and subsequent concentrations are often variable. By spiking the pilot system with known concentrations of selected compounds, the true efficacy of the treatment process can be evaluated. However, it is infeasible to spike all compounds from our target list found in Table 1. Many of these compounds are extremely expensive to purchase in bulk, and others are DEA controlled substances requiring special licenses to possess in the mass range required for the spiking study. For these reasons, we chose a representative subset of compounds for the spiking test (Table 2).

Table 2. Target Compounds for Spiking Experiment

Chemical	Mass available	Concentration	Form
TCEP	25 g	97.0%	Liquid
Oxybenzone	5 g	98.0%	Powder
Caffeine	25 g	99.0%	Powder
Triclosan (Irgasan)	5 g	97.0%	Powder
DEET	250 mg	97.3%	Liquid
Ibuprofen	1 g	98.0%	Powder
Estrone	1 g	99.0%	Powder
Iopromide	400 mg	97.9%	Powder

As can be deduced from Table 1, the compounds chosen for the spiking test represent a variety of chemical structure. Likewise, the spiking target compounds represent important classes of compounds that have been shown to be readily removed and challenging to remove using RO technology, based on our past experiences (Snyder, Adham et al. 2006). Tables 3-6 and Figures 2 and 3 share some examples of previous research related to EDCs and PPCPs in water. Table 7 shows the most commonly detected target compounds in a survey of 18 drinking water utilities across the United States. Estrone is one of the estrogen steroids of greatest occurrence in wastewater, and has been detected in US source waters (Table 7). Moreover, estrone is a phenolic steroid (Table 1) and has chemical reactivity similar to that of the far less frequently detected estradiol and ethynylestradiol. TCEP is a flame-retardant that has been shown to be a ubiquitous contaminant of reuse water. Likewise, it is an aliphatic compound that has been difficult to remove by all treatment processes evaluated by our group. Oxybenzone is a phenolic and acidic chemical used as a sunblock in personal care products. Detection of oxybenzone is highly dependant upon pH as it becomes appreciably ionized at pHs greater than 6. Triclosan is an antimicrobial that has received considerable attention due to its high consumptive use and its claimed formation of toxic byproducts when exposed to free chlorine. Triclosan is highly light sensitive, and our group has demonstrated that triclosan can be removed by UV irradiation and chemical oxidation (Snyder 2005). DEET is known mostly as an insect repellent; however, it is also a widely used industrial chemical. DEET has been detected in nearly all drinking water source waters evaluated by my group (Table 7). It has also been widely studied by the USGS and our group has seen evidence that it can breach certain RO systems (Snyder, Adham et al. 2006). Ibuprofen is a widely used over the counter pain reliever. In our chemical oxidation studies, ibuprofen is one of the most difficult to removal compounds (Figure 3). Iopromide is yet another compound with ubiquitous occurrence and fairly high levels (100s of ng/L). Iopromide is an x-ray contrast media widely used in high concentration for diagnostic testing. It has been detected in wastewater effluent globally and is high resistant to most forms of chemical oxidation (chlorine, chloramine, ozone).

Table 3. Removal of Target Analytes During Full-Scale RO with UV/Peroxide

	<i>MF INF</i>	<i>MF EFF</i>	<i>RO EFF</i>	<i>UV AOP EFF</i>
<i>Hydrocodone</i>	54	51	<1.0	<1.0
<i>Trimethoprim</i>	248	227	<1.0	<1.0
<i>Caffeine</i>	1037	994	<10	<10
<i>Erythromycin-H₂O</i>	191	181	<1.0	<1.0
<i>Sulfamethoxazole</i>	1050	1030	1.9	<1.0
<i>Pentoxifylline</i>	39	33	<1.0	<1.0
<i>Meprobamate</i>	308	260	<1.0	<1.0
<i>Dilantin</i>	175	180	<1.0	<1.0
<i>TCEP</i>	407	370	<10	<10
<i>Carbamazepine</i>	258	237	<1.0	<1.0
<i>DEET</i>	3167	2430	4.4	2.2
<i>Oxybenzone</i>	121	77	6.1	2.1
<i>Estrone</i>	137	158	<1.0	<1.0
<i>Estradiol</i>	11	14	<1.0	<1.0
<i>Iopromide</i>	127	131	<1.0	<1.0
<i>Naproxen</i>	516	621	1.2	<1.0
<i>Ibuprofen</i>	379	500	<1.0	<1.0
<i>Diclofenac</i>	49	59	<1.0	<1.0
<i>Triclosan</i>	136	64	<1.0	<1.0
<i>Gemfibrozil</i>	2740	3750	2.4	1.1
<i>Galaxolide</i>	1130	1084	11	<10
<i>Musk Ketone</i>	61	68	<10	<10

Table 4. Evaluation of SNWA RO Pilot using Spiked Influent Water (ng/L)

	<i>Feed Tank</i>	<i>Post Antiscalant</i>	<i>Brine Recycle</i>	<i>Final Permeate</i>
Trimethoprim	265	294	268	<25
Caffeine	311	324	344	52
Fluoxetine	263	284	499	<25
Pentoxifylline	458	483	471	45
Dilantin	259	275	287	<25
Oxybenzone	218	176	192	<25
Estriol	128	78	58	<25
Ethinylestradiol	125	65	58	<25
Estrone	167	57	78	<25
Estradiol	125	66	57	<25
Progesterone	285	324	312	<25
Androstenedione	284	306	315	<25
Iopromide	165	170	158	<25
Naproxen	118	129	119	<25
Ibuprofen	259	244	251	<25
Diclofenac	26	32	31	<25
Triclosan	246	185	180	<25
Gemfibrozil	230	211	218	<25

Table 5. Pilot-Scale Evaluation of UF/RO by SNWA (ng/L)

	<i>Secondary Effluent</i>	<i>UF Effluent</i>	<i>RO Permeate</i>	<i>Retentate</i>
Hydrocodone	87	89	<1.0	215
Trimethoprim	186	158	<1.0	403
Acetaminophen	<20	<10	<1.0	16
Caffeine	<20	14	<10	298
Erythromycin-H ₂ O	336	357	<1.0	940
Sulfamethoxazole	90	56	1.2	121
Fluoxetine	<20	<10	<1.0	17
Meprobamate	693	715	<1.0	1610
Dilantin	126	191	<1.0	416
TCEP	189	219	<10	426
Carbamazepine	110	147	<1.0	278
DEET	104	103	<1.0	293
Oxybenzone	48	26	<1.0	20
Estrone	35	<10	<1.0	78
Iopromide	<20	58	1.1	89
Naproxen	<20	17	<1.0	33
Diclofenac	<20	37	<1.0	59
Triclosan	29	<10	<1.0	14
Gemfibrozil	100	142	<1.0	329
Galaxolide	968	816	<10.0	2180
Musk Ketone	97	106	<10.0	329

Table 6. Full-Scale MF/RO during Contaminant Treatment Studies

	MF INF	MF EFF	Single Pass RO EFF	Double Pass RO EFF
Hydrocodone	62	104	<1.0	<1.0
Trimethoprim	248	409	<1.0	<1.0
Acetaminophen	16	10	<1.0	<1.0
Caffeine	3460	6125	16	<10
Erythromycin-H ₂ O	312	507	<1.0	<1.0
Sulfamethoxazole	341	805	2	<1.0
Fluoxetine	12	23	<1.0	<1.0
Pentoxifylline	67	109	<1.0	<1.0
Meprobamate	230	341	<1.0	<1.0
Dilantin	207	336	<1.0	<1.0
TCEP	300	467	<10	<10
Carbamazepine	174	271	<1.0	<1.0
DEET	2020	3365	3.4	<1.0
Oxybenzone	31	60	1.9	<1.0
Estrone	85	63	<1.0	<1.0
Iopromide	1670	1810	2.3	<1.0
Naproxen	1068	1205	2.0	<1.0
Ibuprofen	354	422	<1.0	<1.0
Diclofenac	56	49	<1.0	<1.0
Triclosan	620	424	<1.0	<1.0
Gemfibrozil	2885	3040	2.7	<1.0

Table 7. Occurrence of Target Compounds in US Raw Drinking Water (ng/L)

	AVE	SD	Hits	Percent
DEET	10.8	7.9	18	100.0
Caffeine	26.6	19.9	17	94.4
TCEP	21.9	18.2	17	94.4
Dilantin	4.1	3.7	16	88.9
Carbamazepine	5.7	6.2	16	88.9
Sulfamethoxazole	17.8	15.6	15	83.3
Ibuprofen	7.3	7.6	15	83.3
Atrazine	153.8	225.1	14	77.8
Meprobamate	6.8	4.5	12	66.7
Iopromide	13.8	16.1	11	61.1
Naproxen	5.6	6.1	11	61.1
Gemfibrozil	6.1	4.1	11	61.1
Erythromycin-H ₂ O	2.7	0.8	8	44.4
Triclosan	1.7	0.9	5	27.8
Trimethoprim	2.3	0.1	4	22.2
Acetaminophen	3.6	4.0	4	22.2
Hydrocodone	2.0	0.1	2	11.1
Oxybenzone	1.3	0.4	2	11.1
Estrone	1.4	0.0	1	5.6
Testosterone	1.0	0.0	1	5.6
Androstenedione	1.9	0.0	1	5.6

Table 8 shows the results of the initial testing of the San Diego membrane skids in February 2005. Only compounds with detectable concentrations are shown, all other target compounds were below the analytical limits of detection.

In my professional opinion, these results are as expected and show excellent analytical reproducibility. During this testing, we observed trace breaching of dilantin, carbamazepine, DEET, and iopromide. We have seen several of these compounds in RO effluents previously (Tables 3-6). Note that the concentrations detected are at or just above the reporting limit of 1 ng/L for these compounds.

Table 8. San Diego RO Membrane Skid – February 2005 (ng/L)

	<i>RO Feed</i>	<i>RO Feed</i>	<i>RO EFF-1</i>	<i>RO EFF-2</i>	<i>RO EFF-3</i>	<i>RO EFF-4</i>
<i>Hydrocodone</i>	45	54	<1.0	<1.0	<1.0	<1.0
<i>Trimethoprim</i>	219	235	<1.0	<1.0	<1.0	<1.0
<i>Erythromycin-H₂O</i>	210	238	<1.0	<1.0	<1.0	<1.0
<i>Sulfamethoxazole</i>	531	637	<1.0	<1.0	<1.0	<1.0
<i>Fluoxetine</i>	35	25	<1.0	<1.0	<1.0	<1.0
<i>Meprobamate</i>	194	207	<1.0	<1.0	<1.0	<1.0
<i>Dilantin</i>	202	221	<1.0	<1.0	<1.0	1.0
<i>TCEP</i>	201	229	<10	<10	<10	<10
<i>Carbamazepine</i>	282	318	<1.0	<1.0	<1.0	1.1
<i>DEET</i>	161	183	<1.0	<1.0	<1.0	1.2
<i>Estrone</i>	34	30	<1.0	<1.0	<1.0	<1.0
<i>Iopromide</i>	475	567	<1.0	1.0	<1.0	<1.0
<i>Naproxen</i>	64	104	<1.0	<1.0	<1.0	<1.0
<i>Diclofenac</i>	47	56	<1.0	<1.0	<1.0	<1.0
<i>Gemfibrozil</i>	438	620	<1.0	<1.0	<1.0	<1.0

Table 9 shows the results of the San Diego membrane skids in March 2005. Again, only detectable compounds are shown. During this study we detected a high level of triclosan in the final permeate. However, we believe this concentration is most likely contamination. Triclosan is a widely used antimicrobial found in hand soaps as up to a 5% ingredient (parts per hundred). During the March evaluation, we observed trace breaching of dilantin, carbamazepine, DEET, oxybenzone, and iopromide. Note that the influent water was diluted to bring target analytes into the linear range of our method. During this testing, we observed trace breaching of dilantin, carbamazepine, DEET, and iopromide. Once again, these compounds have been found previously in RO effluents (Tables 3-6). It has been hypothesized that some of these compounds are able to breach the membrane at trace levels by partitioning into, then diffusing out of, the membrane material. This hypothesis is credible as the concentration in the feed water are quite high for these compounds, hence driving equilibrium partitioning into the membrane materials. Also of particular interest is the apparent increase in concentration many target analytes post-UF as compared to the tertiary effluent. While the exact reason this phenomena is observed has not be deduced. However, this has been documented in several other experiments using UF and MF membranes (Tables 3-6). While it is possible that this is an analytical anomaly, the surrogate recoveries from these samples were not significantly different suggesting that the apparent increase is not analytically related.

Table 9. San Diego Membrane Results from March 2005 (ng/L)

	<i>Tertiary Effluent</i>	<i>UF Permeate</i>	<i>RO Permeate</i>	<i>Blank</i>
<i>Hydrocodone</i>	80	91	<1.0	<1.0
<i>Trimethoprim</i>	383	427	2.2	<1.0
<i>Erythromycin-H₂O</i>	335	375	<1.0	<1.0
<i>Sulfamethoxazole</i>	758	834	3.7	<1.0
<i>Fluoxetine</i>	46	55	<1.0	<1.0
<i>Meprobamate</i>	252	279	1.5	<1.0
<i>Dilantin</i>	133	144	1.0	<1.0
<i>TCEP</i>	353	360	<10	<10
<i>Carbamazepine</i>	223	254	1.6	<1.0
<i>DEET</i>	146	164	<1.0	<1.0
<i>Diazepam</i>	4.5	10	<1.0	<1.0
<i>Estrone</i>	18	16	<1.0	<1.0
<i>Androstenedione</i>	4.4	4.8	<1.0	<1.0
<i>Iopromide</i>	633	717	<1.0	<1.0
<i>Naproxen</i>	48	50	<1.0	<1.0
<i>Ibuprofen</i>	24	27	<1.0	<1.0
<i>Diclofenac</i>	52	55	<1.0	<1.0
<i>Triclosan</i>	94	127	453	<1.0
<i>Gemfibrozil</i>	146	160	<1.0	<1.0

Table 10 shows the results of the San Diego membrane skids in April 2005. During this study we also detected a high level of triclosan in the final permeate and the travel blank. Once again, this indicates that triclosan has indeed contaminated some of these samples. In my opinion, triclosan removal can not be evaluated from the March and April data. During the April testing, we once again observed trace breaching of some target compounds near the analytical reporting limits. The breaching in April appears to be greater than the previous testing had shown. However, the use of UV/peroxide has reduced the concentrations of all target analytes in the RO permeate to less than detection post-UV/peroxide (again, excluding triclosan which is readily removed by UV – Figures 2 & 3).

Table 10. San Diego Membrane Results from April 2005 (ng/L)

	<i>Tertiary Effluent</i>	<i>UF Permeate</i>	<i>RO Permeate</i>	<i>UV/AOP EFF</i>	<i>Travel Blank</i>
<i>Hydrocodone</i>	87	78	<1.0	<1.0	<1.0
<i>Trimethoprim</i>	346	335	2.6	<1.0	<1.0
<i>Erythromycin-H₂O</i>	311	286	<1.0	<1.0	<1.0
<i>Sulfamethoxazole</i>	817	787	3.6	<1.0	<1.0
<i>Fluoxetine</i>	36	37	<1.0	<1.0	<1.0
<i>Meprobamate</i>	271	256	1.5	<1.0	<1.0
<i>Dilantin</i>	117	113	<1.0	<1.0	<1.0
<i>TCEP</i>	225	220	<10	<10	<10
<i>Carbamazepine</i>	327	309	2.4	<1.0	<1.0
<i>DEET</i>	393	375	2.6	<1.0	<1.0
<i>Diazepam</i>	1.2	1.0	<1.0	<1.0	<1.0
<i>Oxybenzone</i>	1.4	1.4	<1.0	<1.0	<1.0
<i>Estrone</i>	6.3	19	<1.0	<1.0	<1.0
<i>Androstenedione</i>	4.9	3.7	<1.0	<1.0	<1.0
<i>Iopromide</i>	453	681	1.4	<1.0	<1.0
<i>Naproxen</i>	23	31	<1.0	<1.0	<1.0
<i>Ibuprofen</i>	28	37	<1.0	<1.0	<1.0
<i>Diclofenac</i>	71	104	<1.0	<1.0	<1.0
<i>Triclosan</i>	171	334	172	194	175
<i>Gemfibrozil</i>	222	343	<1.0	<1.0	<1.0

Figure 2. Medium-Pressure Collimated Beam Experiment using Colorado River

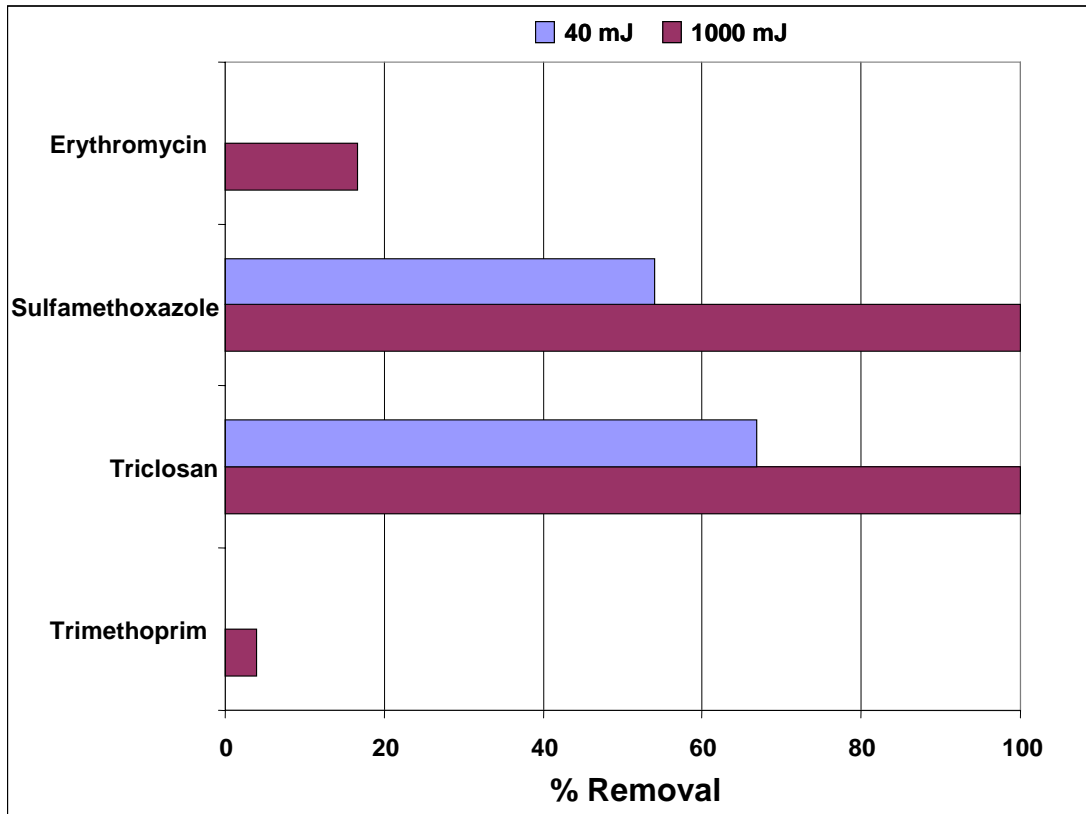
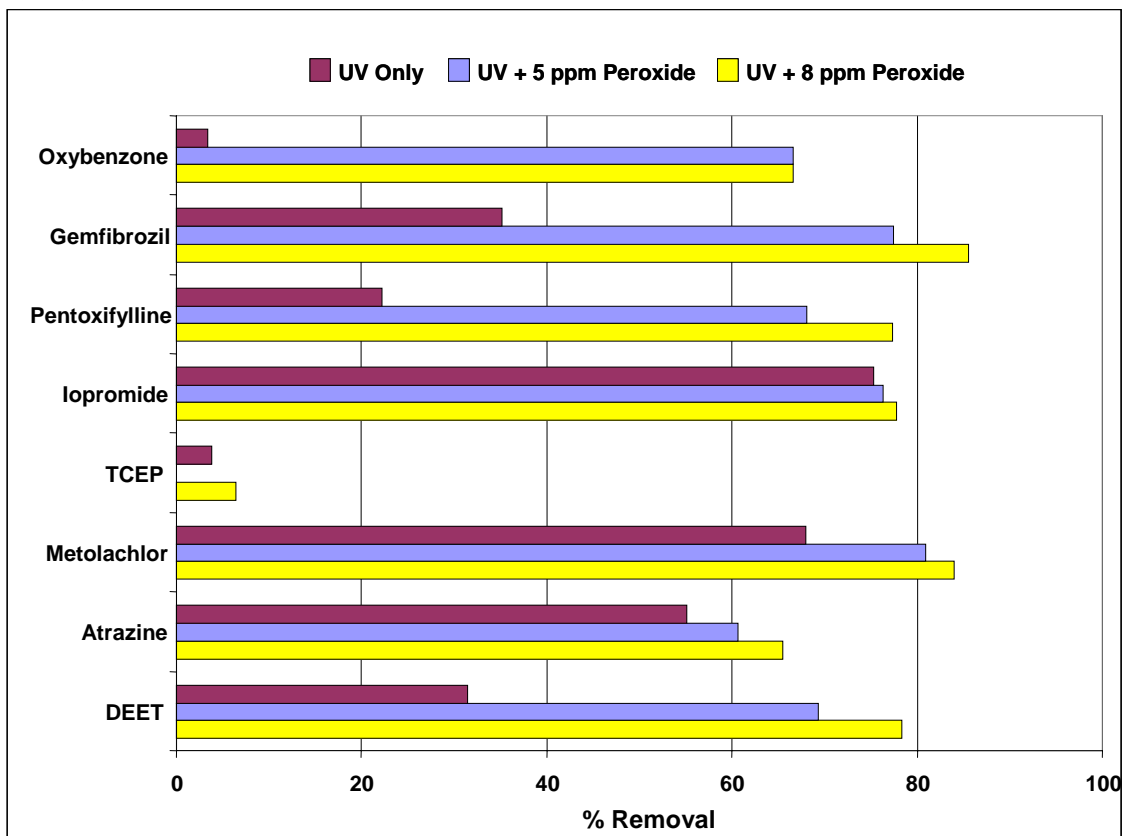

Figure 3. Pilot-Scale Medium Pressure Experiment with AOP



Tables 11 and 12 show the results of the San Diego membrane/UV-AOP spiking study from May 2005. During this study, the target analytes previously shown in Table 2 were spiked at a nominal dose of 500 ng/L. Samples were collected from the UV/AOP pilot influent and effluent at 5, 10, and 17.5 minutes. Raw data for each sample are shown in Table 11, while Table 12 provides a summary of the influent and effluent samples along with percent removal. As expected, many compounds were significantly removed by UV/peroxide AOP, while TCEP was fairly resistant to the AOP. This is consistent with experiments conducted previously by my team at SNWA using pilot facilities at Trojan Technologies (Figure 3). Note that Table 11 shows several compounds (trimethoprim, sulfamethoxazole, carbamazepine, and estradiol) that were not intentionally spiked (see Table 2 for spiked compounds). With the exception of estradiol, the other compounds must have been present in the influent water. Estradiol was detected, as it is a common contaminant of estrone standards. I find the estradiol data to be of great value since it is very consistent, and present at an environmentally relevant level. These data show that even at concentrations much greater than would be expected in a secondary effluent, the AOP can remove nearly all compounds by greater than 2-log (TCEP is the exception). For those compounds present in the RO permeate at ng/L levels, the secondary AOP barrier removed these contaminants to less than one ng/L. A single travel blank collected with these samples showed trace levels (near detection) of iopromide, ibuprofen, and DEET; therefore, actual removal of these compounds may be even greater than those calculated in Table 12.

Table 11. Spiking Experiment to Evaluate UV/Peroxide (ng/L)

	UV/AOP Influent			UV/AOP Effluent		
	5 min	10 min	17.5 min	5 min	10 min	17.5 min
<i>Trimethoprim</i>	1.7	1.5	1.8	<1.0	<1.0	<1.0
<i>Caffeine</i>	659	674	827	<10	<10	<10
<i>Sulfamethoxazole</i>	2.3	2.1	2.7	<1.0	<1.0	<1.0
<i>TCEP</i>	731	716	897	467	511	530
<i>Carbamazepine</i>	1.0	1.1	1.2	<1.0	<1.0	<1.0
<i>DEET</i>	630	659	755	4.0	3.4	3.4
<i>Oxybenzone</i>	276	337	370	<1.0	<1.0	<1.0
<i>Estrone</i>	80	84	104	<1.0	<1.0	<1.0
<i>Estradiol</i>	2.2	2.8	3.1	<1.0	<1.0	<1.0
<i>Iopromide</i>	579	620	740	5.6	5.5	4.7
<i>Ibuprofen</i>	684	682	813	1.8	2.0	2.4
<i>Triclosan</i>	321	345	411	1.7	1.1	1.8

Table 12. Summary Data from UV/Peroxide Pilot Experiment (ng/L)

	UV/AOP Influent		UV/AOP Effluent		Removal
	AVE	SD	AVE	SD	%
<i>Trimethoprim</i>	1.7	0.2	<1.0	NA	>40
<i>Caffeine</i>	720	93	<10	NA	>98
<i>Sulfamethoxazole</i>	2.4	0.3	<1.0	NA	>58
<i>TCEP</i>	781	100	503	32	36
<i>Carbamazepine</i>	1.1	0.1	<1.0	NA	>9
<i>DEET</i>	681	65	3.6	0.3	>99
<i>Oxybenzone</i>	328	48	<1.0	NA	>99
<i>Estrone</i>	89	13	<1.0	NA	>98
<i>Estradiol</i>	2.7	0.5	<1.0	NA	>63
<i>Iopromide</i>	646	84	5.3	0.5	>99
<i>Ibuprofen</i>	726	75	2.1	0.3	>99
<i>Triclosan</i>	359	47	1.5	0.4	>99

Additional samples were collected from the RO pilot system during operation on August 16th, August 30th, and September 20th to evaluate system performance for EDC/PPCP treatment. Results are shown in Tables 13, 14, and 15. All compounds in all blanks were less than detection, with the exception of a trace amount (1.6 ng/L) of oxybenzone (a common sunscreen) in the September 20th sample.

Table 13. RO Pilot Data from August 16th, 2005 (ng/L)

	<i>Tertiary Effluent</i>	<i>RO Feed</i>	<i>RO Perm Stage 1</i>	<i>RO Perm Stage 2</i>	<i>RO Perm Combined</i>	<i>Travel Blank</i>
<i>Hydrocodone</i>	80	102	<1.0	<1.0	<1.0	<1.0
<i>Trimethoprim</i>	270	328	<1.0	1.6	<1.0	<1.0
<i>Acetaminophen</i>	<10	<10	<1.0	<1.0	<1.0	<1.0
<i>Caffeine</i>	<100	<100	<10	<10	<10	<10
<i>Erythromycin-H₂O</i>	166	211	<1.0	<1.0	<1.0	<1.0
<i>Sulfamethoxazole</i>	506	574	<1.0	1.9	<1.0	<1.0
<i>Fluoxetine</i>	37	55	<1.0	<1.0	<1.0	<1.0
<i>Pentoxifylline</i>	<10	<10	<1.0	<1.0	<1.0	<1.0
<i>Meprobamate</i>	229	262	<1.0	1.2	<1.0	<1.0
<i>Dilantin</i>	116	130	<1.0	<1.0	<1.0	<1.0
<i>TCEP</i>	226	273	<10	<10	<10	<10
<i>Carbamazepine</i>	336	413	<1.0	1.8	<1.0	<1.0
<i>DEET</i>	272	376	<1.0	2.1	1.1	<1.0
<i>Atrazine</i>	<10	<10	<1.0	<1.0	<1.0	<1.0
<i>Diazepam</i>	<10	<10	<1.0	<1.0	<1.0	<1.0
<i>Oxybenzone</i>	<10	<10	1.1	1.0	<1.0	<1.0
<i>Estriol</i>	8.4	<5.0	<5.0	<5.0	<5.0	<5.0
<i>Ethinylestradiol</i>	1.1	<1.0	<1.0	<1.0	<1.0	<1.0
<i>Estrone</i>	30	35	<1.0	<1.0	<1.0	<1.0
<i>Estradiol</i>	3.4	5.0	<1.0	<1.0	<1.0	<1.0
<i>Testosterone</i>	<1.0	<1.0	<1.0	<1.0	<1.0	<1.0
<i>Progesterone</i>	<1.0	<1.0	<1.0	<1.0	<1.0	<1.0
<i>Androstenedione</i>	<1.0	3.8	<1.0	<1.0	<1.0	<1.0
<i>Iopromide</i>	10	10	<1.0	<1.0	<1.0	<1.0
<i>Naproxen</i>	182	139	<1.0	<1.0	<1.0	<1.0
<i>Ibuprofen</i>	19	23	<1.0	<1.0	<1.0	<1.0
<i>Diclofenac</i>	118	157	<1.0	<1.0	<1.0	<1.0
<i>Triclosan</i>	66	34	<1.0	<1.0	<1.0	<1.0
<i>Gemfibrozil</i>	355	357	<1.0	<1.0	<1.0	<1.0

Table 14. RO Pilot Data from August 30th, 2005 (ng/L)

	<i>Tertiary Effluent</i>	<i>RO Feed</i>	<i>RO Perm</i>	<i>Travel Blank</i>
<i>Hydrocodone</i>	80	83	<1.0	<1.0
<i>Trimethoprim</i>	316	313	1.3	<1.0
<i>Acetaminophen</i>	<10	<10	<1.0	<1.0
<i>Caffeine</i>	<100	<100	<10	<10
<i>Erythromycin-H₂O</i>	173	179	<1.0	<1.0
<i>Sulfamethoxazole</i>	599	567	<1.0	<1.0
<i>Fluoxetine</i>	42	43	<1.0	<1.0
<i>Pentoxifylline</i>	<10	<10	<1.0	<1.0
<i>Meprobamate</i>	261	267	<1.0	<1.0
<i>Dilantin</i>	158	157	<1.0	<1.0
<i>TCEP</i>	396	437	<10	<10
<i>Carbamazepine</i>	262	273	<1.0	<1.0
<i>DEET</i>	137	153	<1.0	<1.0
<i>Atrazine</i>	<10	<10	<1.0	<1.0
<i>Diazepam</i>	<10	<10	<1.0	<1.0
<i>Oxybenzone</i>	<10	11	1.4	2.0
<i>Estriol</i>	<5.0	<5.0	<5.0	<5.0
<i>Ethinylestradiol</i>	<1.0	1.5	<1.0	<1.0
<i>Estrone</i>	36	36	<1.0	<1.0
<i>Estradiol</i>	1.9	2.5	<1.0	<1.0
<i>Testosterone</i>	<1.0	<1.0	<1.0	<1.0
<i>Progesterone</i>	<1.0	<1.0	<1.0	<1.0
<i>Androstenedione</i>	2.0	1.5	<1.0	<1.0
<i>Iopromide</i>	29	22	<1.0	<1.0
<i>Naproxen</i>	112	86	<1.0	<1.0
<i>Ibuprofen</i>	48	52	<1.0	<1.0
<i>Diclofenac</i>	46	47	<1.0	<1.0
<i>Triclosan</i>	39	32	<1.0	<1.0
<i>Gemfibrozil</i>	371	364	<1.0	<1.0

Table 15. RO Pilot Data from September 20th, 2005 (ng/L)

	<i>RO Feed</i>	<i>RO Perm Stage 1</i>	<i>RO Perm Stage 2</i>	<i>RO Perm Combined</i>	<i>Travel Blank</i>
<i>Hydrocodone</i>	82	<1.0	<1.0	<1.0	<1.0
<i>Trimethoprim</i>	286	1.2	7.0	3.0	<1.0
<i>Acetaminophen</i>	<10	<1.0	<1.0	<1.0	<1.0
<i>Caffeine</i>	<100	<10	<10	<10	<10
<i>Erythromycin-H₂O</i>	206	<1.0	<1.0	<1.0	<1.0
<i>Sulfamethoxazole</i>	732	2.9	3.3	3.0	<1.0
<i>Fluoxetine</i>	36	<1.0	<1.0	<1.0	<1.0
<i>Pentoxifylline</i>	<10	<1.0	<1.0	<1.0	<1.0
<i>Meprobamate</i>	255	<1.0	1.9	1.0	<1.0
<i>Dilantin</i>	124	<1.0	1.5	<1.0	<1.0
<i>TCEP</i>	300	<10	<10	<10	<10
<i>Carbamazepine</i>	230	<1.0	2.0	1.2	<1.0
<i>DEET</i>	141	<1.0	1.2	<1.0	<1.0
<i>Atrazine</i>	<10	<1.0	<1.0	<1.0	<1.0
<i>Diazepam</i>	<10	<1.0	<1.0	<1.0	<1.0
<i>Oxybenzone</i>	20	1.6	5.1	2.3	1.6
<i>Estriol</i>	<1.0	<5.0	<5.0	<5.0	<5.0
<i>Ethinylestradiol</i>	<1.0	<1.0	<1.0	<1.0	<1.0
<i>Estrone</i>	30	<1.0	<1.0	<1.0	<1.0
<i>Estradiol</i>	5.0	<1.0	<1.0	<1.0	<1.0
<i>Testosterone</i>	<1.0	<1.0	<1.0	<1.0	<1.0
<i>Progesterone</i>	<1.0	<1.0	<1.0	<1.0	<1.0
<i>Androstenedione</i>	3.9	<1.0	<1.0	<1.0	<1.0
<i>Iopromide</i>	<10	<1.0	<1.0	<1.0	<1.0
<i>Naproxen</i>	138	<1.0	<1.0	<1.0	<1.0
<i>Ibuprofen</i>	34	<1.0	<1.0	<1.0	<1.0
<i>Diclofenac</i>	86	<1.0	<1.0	<1.0	<1.0
<i>Triclosan</i>	40	<1.0	3.1	1.4	<1.0
<i>Gemfibrozil</i>	889	2.2	1.5	1.5	<1.0

Due in part to concerns regarding triclosan contamination, three additional samples and one travel blank were collected from the San Diego pilot skid on December 30th, 2005. Samples were collected from the RO feed, RO permeate, and UV/AOP effluent. Results from this testing are shown in Table 16. As expected, triclosan was not detected in the UV/AOP effluent or in the travel blank. Acetaminophen was detected in the UV/AOP effluent; however, this was attributed to a lab error (LE). As Table 16 demonstrates, acetaminophen was not detected in the RO feed, RO effluent, the travel blank, or the laboratory blanks. Trace amounts of DEET and oxybenzone were present in the travel blank at 1.3 and 2.2 ng/L, respectively. Both of these products are typical in sunscreens and we have seen these as common contaminants in travel blanks at ng/L concentrations. When compounds are found in blank samples, standard laboratory protocol suggests increasing the method reporting limit by 3-5x the concentration in the blank. Therefore, for this experiment, the method reporting limit for DEET and oxybenzone were adjusted to 5 ng/L. All QA/QC parameters for this sampling event were excellent, with consistent isotopically-labeled surrogate recovery. I find the data to be robust and consistent with similar projects.

Table 16. Results from December 2005 Sampling Event (ng/L)

	<i>RO Feed</i>	<i>RO Effluent</i>	<i>UV/AOP</i>	<i>Travel Blank</i>	<i>Laboratory Blank</i>
<i>Hydrocodone</i>	82	<1.0	<1.0	<1.0	<1.0
<i>Trimethoprim</i>	432	3.3	<1.0	<1.0	<1.0
<i>Acetaminophen</i>	<10	<1.0	LE	<1.0	<1.0
<i>Caffeine</i>	<100	<10	<10	<10	<10
<i>Erythromycin-H2O</i>	309	<1.0	<1.0	<1.0	<1.0
<i>Sulfamethoxazole</i>	997	2.2	<1.0	<1.0	<1.0
<i>Fluoxetine</i>	28	<1.0	<1.0	<1.0	<1.0
<i>Pentoxifylline</i>	12	<1.0	<1.0	<1.0	<1.0
<i>Meprobamate</i>	327	<1.0	<1.0	<1.0	<1.0
<i>Dilantin</i>	174	<1.0	<1.0	<1.0	<1.0
<i>TCEP</i>	323	<10	<10	<10	<10
<i>Carbamazepine</i>	249	<1.0	<1.0	<1.0	<1.0
<i>DEET</i>	211	<5.0	<5.0	<5.0	<5.0
<i>Atrazine</i>	<10	<1.0	<1.0	<1.0	<1.0
<i>Diazepam</i>	<10	<1.0	<1.0	<1.0	<1.0
<i>Oxybenzone</i>	41	<5.0	<5.0	<5.0	<5.0
<i>Estriol</i>	14	<5.0	<5.0	<5.0	<5.0
<i>Ethinylestradiol</i>	<1.0	<1.0	<1.0	<1.0	<1.0
<i>Estrone</i>	182	<1.0	<1.0	<1.0	<1.0
<i>Estradiol</i>	18	<1.0	<1.0	<1.0	<1.0
<i>Testosterone</i>	<1.0	<1.0	<1.0	<1.0	<1.0
<i>Progesterone</i>	<1.0	<1.0	<1.0	<1.0	<1.0
<i>Androstenedione</i>	6.2	<1.0	<1.0	<1.0	<1.0
<i>Iopromide</i>	583	<1.0	<1.0	<1.0	<1.0
<i>Naproxen</i>	479	1.2	<1.0	<1.0	<1.0
<i>Ibuprofen</i>	120	<1.0	<1.0	<1.0	<1.0
<i>Diclofenac</i>	74	<1.0	<1.0	<1.0	<1.0
<i>Triclosan</i>	324	3.4	<1.0	<1.0	<1.0
<i>Gemfibrozil</i>	1700	1.3	<1.0	<1.0	<1.0

CONCLUSIONS

I find the results of the experiments conducted thus far to be exactly as expected and very similar to data seen in past membrane and AOP experiments. I find the reproducibility for the experiments and analytics to be excellent. We did experience difficulty with triclosan contamination; however, the contamination was eliminated in later experiments. From my experience in EDC/PPCP research, the use of RO membranes followed by UV/peroxide would provide an extremely efficient barrier to eliminate nearly all of these contaminants. Advanced analytical techniques will permit the detection of minute concentrations of various contaminants in water. The data provided in this report confirm that RO followed by UV/AOP will greatly reduce the concentration of emerging contaminants.

I would be happy to accept questions and/or comments regarding this report.

A handwritten signature in blue ink, appearing to read 'Shane A. Snyder', is positioned above the typed name.

Shane A. Snyder Ph.D.
28th January 2006

REFERENCES

- EPA (1997). "Special report on environmental endocrine disruption: an effects assessment and analysis." Office of Research and Development. Washington, D.C. February 1997. EPA/630/R-96/012.
- Bevans, H. E., S. L. Goodbred, et al. (1996). "Synthetic Organic Compounds and Carp Endocrinology and Histology in Las Vegas Wash and Las Vegas and Callville Bays of Lake Mead, Nevada, 1992 and 1995." Water-Resources Investigations Report 96-4266.
- Brookbanks, E. O., R. A. H. Welch, et al. (1969). "Estrogens in pasture and a possible relation with mastitis." New Zealand Veterinary Journal **17**: 159-160.
- Burton, J. L. and M. Wells (2002). "The effect of phytoestrogens on the female genital tract." Journal of Clinical Pathology **55**(6): 401-407.
- Cook, J. W., E. C. Dodds, et al. (1934). "Estrogenic activity of some condensed ring compounds in relation to their other biological activities." Proceedings of the Royal Society of London **B114**: 272-286.
- Desbrow, C., E. J. Routledge, et al. (1998). "Identification of Estrogenic Chemicals in STW Effluent. 1. Chemical Fractionation and in Vitro Biological Screening." Environmental Science & Technology **32**(11): 1549-1558.
- Folmar, L. C., N. D. Denslow, et al. (1996). "Vitellogenin Induction and Reduced Serum Testosterone Concentrations in Feral Male Carp (*Cyprinus carpio*) Captured Near a Major Metropolitan Sewage Treatment Plant." Environmental Health Perspectives **104**(10): 1096-1101.
- Fry, D. M. and C. K. Toone (1981). "DDT-induced feminization of gull embryos." Science **231**: 919-924.
- Fry, D. M., C. K. Toone, et al. (1987). "Sex ratio skew and breeding patterns of gulls: demographic and toxicological considerations." Studies of Avian Biology? **10**: 26-43.
- Garrison, A. W., J. D. Pope, et al. (1975). GC/MS analysis of organic compounds in domestic wastewaters. Chem. Congr. North Am. Cont., Ann Arbor Science.
- Gavaler, J. S., E. R. Rosenblum, et al. (1995). "The phytoestrogen congeners of alcoholic beverages: current status." Proceedings of the Society for Experimental Biological Medicine **208**(1): 98-102.
- Harries, J. E., D. A. Sheahan, et al. (1996). "A survey of estrogenic activity in United Kingdom inland waters." Environmental Toxicology and Chemistry **15**: 1993-2002.
- Hignite, C. and D. L. Azarnoff (1977). "Drugs and drug metabolites as environmental contaminants: chlorophenoxyisobutyrate and salicylic acid in sewage water effluent." Life Sciences **20**(2): 337-341.
- Majewski, A. R., P. J. Blanchfield, et al. (2002). "Waterborne 17.alpha.-ethynylestradiol affects aggressive behaviour of male fathead minnows (*Pimephales promelas*) under artificial spawning conditions." Water Quality Research Journal of Canada **37**(4): 697-710.
- Nimrod, A. C. and W. H. Benson (1996). "Environmental Estrogenic Effects of Alkylphenol Ethoxylates." Critical Reviews in Toxicology **26**(3): 335-364.
- Schueler, F. W. (1946). "Sex-hormonal action and chemical constitution." Science **103**: 221-223.
- Setchell, K. D. R., S. J. Gosselin, et al. (1987). "Dietary estrogens - a probable cause of infertility and liver disease in captive cheetahs." Gastroenterology **93**(2): 225-233.
- Shaw, I. and S. McCully (2002). "A review of the potential impact of dietary endocrine disrupters on the consumer." International Journal of Food Science and Technology **37**(5): 471-476.
- Sluczewski, A. and P. Roth (1948). "Effects of androgenic and estrogenic compounds on the experimental metamorphoses of amphibians." Gynecology and obstetrics **47**: 164-176.
- Snyder, E. M., R. C. Pleus, et al. (2005). "Pharmaceuticals and EDCs in the US water industry - an update." Journal American Water Works Association **97**(11): 32-36.
- Snyder, S. A. (2005). Role of Oxidation in the Removal of Emerging Contaminants from Water. International Ozone Association, Strasbourg France.
- Snyder, S. A., S. Adham, et al. (2006). "Role of Membranes and Activated Carbon in the Removal of Endocrine Disruptors and Pharmaceuticals." Desalination **IN PRESS**.
- Snyder, S. A., T. L. Keith, et al. (1999). "Analytical methods for detection of selected estrogenic compounds in aqueous mixtures." Environmental Science & Technology **33**(16): 2814-2820.
- Snyder, S. A., K. L. Kelly, et al. (2001). Pharmaceuticals and personal care products in the waters of Lake Mead, Nevada. Pharmaceuticals and Personal Care Products in the Environment: Scientific and

- Regulatory Issues. C. G. Daughton and T. L. Jones-Lepp. Washington, D.C., American Chemical Society. **Symposium Series 791**: 116-140.
- Snyder, S. A., E. Snyder, et al. (2000). Instrumental and Bioanalytical Measures of Endocrine Disruptors in Water. Analysis of Environmental Endocrine Disruptors. L. H. Keith, T. L. Jones-Lepp and L. L. Needham. Washington, DC, American Chemical Society: 73-95.
- Snyder, S. A., D. L. Villeneuve, et al. (2001). "Identification and quantification of estrogen receptor agonists in wastewater effluents." Environmental Science & Technology **35**(18): 3620-3625.
- Snyder, S. A., P. Westerhoff, et al. (2003). "Pharmaceuticals, Personal Care Products, and Endocrine Disruptors in Water: Implications for the Water Industry." Environmental Engineering Science **20**(5): 449-469.
- Stroud, S. W. (1940). "Metabolism of the parent compounds of some of the simpler synthetic estrogenic hydrocarbons." Journal of Endocrinology **2**: 55-62.
- Tabak, H. H., R. N. Bloomhuff, et al. (1981). "Steroid hormones as water pollutants II. Studies on the persistence and stability of natural urinary and synthetic ovulation-inhibiting hormones in untreated and treated wastewaters." Dev. Ind. Microbiol. **22**: 497-519.
- Tremblay, L. and G. Van Der Kraak (1999). "Comparison between the effects of the phytosterol .beta.-sitosterol and pulp and paper mill effluents on sexually immature rainbow trout." Environmental Toxicology and Chemistry **18**(2): 329-336.
- van Aerle, R., N. Pounds, et al. (2002). "Window of Sensitivity for the Estrogenic Effects of Ethinylestradiol in Early Life-Stages of Fathead Minnow, *Pimephales promelas*." Ecotoxicology **11**(6): 423-434.
- Van den Belt, K., R. Verheyen, et al. (2003). "Effects of 17.alpha.-ethinylestradiol in a partial life-cycle test with zebrafish (*Danio rerio*): effects on growth, gonads and female reproductive success." Science of the Total Environment **309**(1-3): 127-137.
- Vanderford, B. J., R. A. Pearson, et al. (2003). "Analysis of Endocrine Disruptors, Pharmaceuticals, and Personal Care Products in Water Using Liquid Chromatography/Tandem Mass Spectrometry." Analytical Chemistry **75**(22): 6265-6274.
- Walker, B. S. and J. C. Janney (1930). "Estrogenic substances. II. Analysis of plant sources." Endocrinology **14**: 389-392.
- Wanibuchi, H., J. S. Kang, et al. (2003). "Toxicity vs. Beneficial effects of phytoestrogens." Pure and Applied Chemistry **75**(11-12): 2047-2053.
- Wutte, W., H. Jarry, et al. (2003). "Phytoestrogens: endocrine disruptors or replacement for hormone replacement therapy?" Maturitas **44**(Supplement 1): S9-S20.

APPENDIX D: AWT PRODUCT WATER QUALITY

COMPARISON

CITY OF SAN DIEGO

Note: The City staff memo contained in the following Appendix compares AWT product water quality measured during pilot testing to existing historical source water quality (i.e. Comparison #2). As described in Section 4.2.2 of this report, AWT product water quality was also compared to water quality measured in grab samples taken from two of the City's source waters during the pilot test period (i.e. Comparison #1). Results from these two comparisons differ. For example, Comparison # 1 showed NDMA and 1,4 dioxane to be higher in concentration in the AWT product while Comparison #2 does not. Comparison #2 lists boron, carbon dioxide, and nitrogen as higher in the AWT while Comparison #1 does not. These differences are attributed to the data used and the data averaging method. The data used in Comparison #2 included all generated during the pilot study plus additional historical source water quality data. Also, the city staff evaluation recorded averages which fell below the MDL as ND per state reporting protocols.



THE CITY OF SAN DIEGO

May 31, 2006

James F. DeCarolus, Senior Engineer
MWH Americas, Inc.
Applied Research Department
9444 Farnham Street, Suite 300
San Diego, CA 92123

Dear Mr. DeCarolus:

Subject: Water Reuse Research Studies at the North City Water Reclamation Plant
Draft Statement for Water Quality Data Comparison

The purpose of this letter is to provide a comparison of data obtained from this research study with water quality data from the Colorado River (CR), State Project Water (SPW) and local source water from five of the City's reservoirs which contain a blend of imported water (CR and SPW) and local runoff. Data reflecting the water quality of the CR and SPW was obtained from the Metropolitan Water District of Southern California (MWD). MWH's laboratory and the City of San Diego Water Quality Laboratory (SDWQL) provided data on tertiary water and AWT product water from NCWRP in addition to local lake water quality data. Some of this local lake data was obtained in conjunction with the research study while other data was the product of routine analyses performed by the SDWQL.

In addition, the Southern Nevada Water Authority Research Laboratory analyzed samples from the tertiary water, AWT product water, and two local lakes for 29 commonly found endocrine disrupting compounds (EDCs), pharmaceuticals and personal care products (PPCPs). This data was compiled by Enrique Salvatierra, the Technical Assistant and reviewed by me as Technical Manger.

The type of analyses, when samples were analyzed and the location they were taken is detailed in the accompanying spreadsheet. While maximum contaminant levels (MCL), notification levels and reporting levels are set by state and federal authorities, laboratories vary in method detection levels of analyses and the units used to report data (parts per million versus parts per billion, for example). For this reason, comparison of data to established MCLs, if any, were made. It must be noted that some data in this report from CR, SPW and local sources may be based on quarterly or monthly sampling schedules while others are only required to be reported once per year or longer basis, such as radiological analyses, which are only required to be performed four consecutive quarters every four years. Since radiation is usually only associated with groundwater and San Diego's water originates from surface sources, radiation only need to be analyzed on a minimal basis.

Water Reuse Study • Water Department

600 B Street, Suite 700, MS 907 • San Diego, CA 92101-4518

tel (619) 533-4242 Fax (619) 533-5278

www.sandiego.gov/water/waterreusstudy



A total of two hundred thirty-two (232) of the listed contaminants/constituents were analyzed in both the AWT product water and the local raw water supply. AWT product water contaminant/constituent concentrations were lower than or equivalent to that in the local raw water supply for two hundred twenty-six (226) of the parameters. Six (6) parameters were found to be higher in AWT product water than the raw water supply (boron, free carbon dioxide, nitrogen, nitrate, chloroform and total trihalomethanes).

Boron was found in slightly higher concentrations in AWT water, but well below its notification level, which is a non-regulatory standard below which no suspected health effects are probable. Boron is a naturally-occurring element and is non-toxic in most of its forms. It's been estimated that most people consume between 10 to 25 milligrams every day from the food they eat, or the equivalent of 36 to 90 times the amount found in one liter of AWT water.

The level of free carbon dioxide in AWT water was about 1/3 higher than in San Diego source water. There is no standard for free carbon dioxide in drinking water and the most common concern is that acid produced by excess carbon dioxide combining with water to corrode metal pipes. Both beer and sodas are "super-saturated" with free carbon dioxide, which forms bubbles when pressure is released and it comes out of solution after the can or bottle is opened.

Nitrogen and nitrate as nitrogen were found in greater abundance in AWT water than raw water in concentrations at about one-tenth the MCL for drinking water. Nitrate is formed when nitrogen combines with oxygen and is usually only considered a problem when it promotes excess plant growth, such as aquatic algae blooms. Nitrate in concentrations greater than 10 milligrams per liter can lead to blue baby syndrome in babies younger than six months of age. Nitrate is commonly used as a preservative in dried meats, such as salami.

AWT water contained slightly higher amounts of chloroform and total trihalomethanes (THMs). Chloroform is a one component of the group of chemicals known as total trihalomethanes (TTHMs). These "disinfection byproducts" (DBPs) are formed when chlorine, the most commonly used disinfectant in the drinking water industry, is added to water containing carbon compounds. In addition to killing any bacteria in the water, chlorine binds to compounds containing carbon to form chloroform and other THMs. Chloroform, first used as an anesthetic in the mid-1800s, has been shown to cause miscarriages or birth defects when inhaled at concentrations greater than 30 parts per million. There is no individual drinking water standard for chloroform itself, but the drinking water standard for total THMs is 80 parts per billion. Both chloroform and TTHMs were found in significantly lower amounts than are commonly found in drinking water.

This data indicates that AWT water is superior to San Diego's current raw water supply. Of the six (6) constituents found in the AWT at higher levels than San Diego's current raw water, all were well below any known level of human health concern. The human health risk from consuming AWT water directly is negligible, especially when compared to current drinking water standards and with other water supplies available to San Diego.

Page 3 of 3
Mr. Decarolis, Senior Engineer
May 31, 2006

Augmenting San Diego's raw water supply with AWT water would result in an improvement to water quality over its current water supplies.

Sincerely,

A handwritten signature in blue ink, appearing to read "R. Coss", written in a cursive style.

Ronald Coss
Technical Manger
Water Reuse Study

RJC/BP

Enclosure: Water Quality Comparison Spreadsheet

Water Quality Comparison - Colorado River (CR), State Project Water (SPW), City of San Diego (SD)

Water Quality Comparison - Colorado River (CR), State Project Water (SPW), City of San Diego (SD)								
Constituent	Metric Units	Units	Maximum Contaminant Level (MCL)	Colorado River Yearly Average²	State Water Project Yearly Average²	San Diego Source Water Yearly Average^{5A}	NCWRP Tertiary Effluent Average^{5B}	NCWRP UV + Peroxide Average⁶
Inorganics and Physical Parameters								
Asbestos	MFL	MFL	7	ND	ND	ND**	na	ND ^h
Bicarbonate	mg/L	ppm	none	159	107	142	na	7.88 ^h
Boron	mg/L	ppm	1 ^d	0.14	0.18	0.115	0.379	0.275 ^{g,p}
Bromide	mg/L	ppm	none	0.09	0.22	0.207	0.455	ND ^g
Calcium	mg/L	ppm	none	71	25	50.7	na	ND ^h
Carbonate	mg/L	ppm	none	0	0	3.51	na	ND ^{h,i}
Chloride	mg/L	ppm	250 ^a	87	70	100	255	6.9
Cyanide	mg/L	ppm	0.2	ND	ND	ND	na	ND ^h
Fluoride	mg/L	ppm	2 ^a	0.34	0.13	0.28	na	ND ^h
Free Carbon Dioxide	mg/L	ppm	none	1.5	1.8	2.9**	na	3.86 ^{h,j}
Magnesium	mg/L	ppm	none	29	14	25.6	na	ND ^h
Nitrate as NO ₃	mg/L	ppm	45	0.9	2.3	0.85	45.3	5.3 ^p
Nitrate as N	mg/L	ppm	10	na	na	ND** ⁱ	na	1.0 ^{h,p}
Nitrite, N	mg/L	ppm	1	na	na	0.078	na	ND ^h
Phosphorous	mg/L	ppm	none	na	na	0.041	na	na
Potassium	mg/L	ppm	none	4.9	3.1	5.10	19.4	ND
Silica	mg/L	ppm	none	8.5	10.5	11.3	16.0	0.607 ^g
Sodium	mg/L	ppm	none	95	53	79.6	190	6.0 ^h
Sulfate	mg/L	ppm	250 ^a	245	45	142	241	0.722
Foaming Agents (Detergents, Surfactants, MBAS)	mg/L	ppm	0.5 ^a	ND	ND	ND	na	ND ^h
Total Organic Carbon (TOC)	mg/L	ppm	none	3.30	3.89	6.49	8.77	ND ^g
Total Dissolved Solids (TDS)	mg/L	ppm	500 ^a	620	275	508	998	40
Total Hardness as CaCO ₃	mg/L	ppm	none	297	118	234	356	ND ⁱ
Total Alkalinity as CaCO ₃	mg/L	ppm	none	131	88	123	144	6.96
H ⁺ Concentration (pH)	pH	pH	6.5-8.5 ^a	8.24	8.00	8.33	na	6.6 ^h
Specific Conductance (Conductivity)	μmho/cm	μmho/cm	900 ^a	1003	505	1117	1957	58
Color	CU	CU	15 ^a	5	14	15	na	ND ^h
Turbidity	NTU	NTU	5 ^a	3.8	3.5	1.76	na	0.20 ^h
Alkalinity_Partial	mg/L	ppm	none	na	na	3.71	ND	ND ^g
Hardness_Ca	mg/L	ppm	none	na	na	128	201	3.37 ^g

Water Quality Comparison - Colorado River (CR), State Project Water (SPW), City of San Diego (SD)

Constituent	Metric Units	Units	Maximum Contaminant Level (MCL)	Colorado River Yearly Average²	State Water Project Yearly Average²	San Diego Source Water Yearly Average^{5A}	NCWRP Tertiary Effluent Average^{5B}	NCWRP UV + Peroxide Average⁶
Radionuclides^{8,9}								
Gross Alpha	pCi/L	pCi/L	15	4.05	1.93	<3**	na	<3 ^h
Gross Beta	pCi/L	pCi/L	50	4.04	3.20	3.4**	na	<3 ^h
Radium226	pCi/L	pCi/L	5 ⁱ	ND	ND	na	na	na
Radium228	pCi/L	pCi/L	5 ⁱ	ND	ND	<1**	na	<1 ^h
Strontium90	pCi/L	pCi/L	8	ND	ND	na	na	na
Tritium	pCi/L	pCi/L	20,000	ND	ND	na	na	na
Uranium, Total	pCi/L	pCi/L	20	2.74	0.54	na	na	na
Radon 222	pCi/L	pCi/L	none	49	39	na	na	na
Metals								
Aluminum	μg/L	ppb	200 ^a	93	87	26.7	11.6	ND
Antimony	μg/L	ppb	6	ND	ND	ND	ND ⁱ	ND ^h
Arsenic¹²	μg/L	ppb	10	3.0	2.3	ND ⁱ	2.18	ND
Barium	μg/L	ppb	1,000	151	41	65.6	55.7	ND
Beryllium	μg/L	ppb	4	ND	ND	ND	ND	ND
Cadmium¹²	μg/L	ppb	5	ND	ND	ND	ND	ND
Chromium	μg/L	ppb	50	ND	ND	ND	na	ND ^h
Chromium 6	μg/L	ppb	50	ND	0.12	na	na	na
Copper	μg/L	ppb	1,300 ^d (1,000 ^a)	ND	ND	7.01	6.66	ND ⁱ
Iron	μg/L	ppb	300 ^a	17	20	58.1	na	ND ^h
Lead¹²	μg/L	ppb	15 ^d	ND	ND	ND	ND ⁱ	ND
Lithium	μg/L	ppb	none	47	ND	na	na	na
Manganese	μg/L	ppb	500 ^d (50 ^a)	ND	6	34.7	107	ND ⁱ
Mercury¹²	μg/L	ppb	2	ND	ND	ND	na	ND ^h
Molybdenum	μg/L	ppb	none	6	3	na	na	na
Nickel	μg/L	ppb	100	3	ND	1.11	5.81	ND
Selenium	μg/L	ppb	50	ND	ND	ND	3.31	ND
Silver	μg/L	ppb	100 ^a	ND	ND	ND	ND	ND
Strontium	μg/L	ppb	8	1100	255	na	na	na
Thallium	μg/L	ppb	2	ND	ND	ND	ND	ND
Vanadium	μg/L	ppb	50 ^d	2.8	3.9	1.89	3.3	ND ^g
Zinc	μg/L	ppb	5,000 ^a	ND	ND	2.72	29.1	ND

Water Quality Comparison - Colorado River (CR), State Project Water (SPW), City of San Diego (SD)

Constituent	Metric Units	Units	Maximum Contaminant Level (MCL)	All Imported Water Sources^{10A,10B} (CR, SPW & Blended)	San Diego Source Water Yearly Average^{5A}	NCWRP Tertiary Effluent Average^{5B}	NCWRP UV + Peroxide Average⁶
Oxygenates							
diisopropyl ether (DIPE)	μ g/L	ppb	none	ND	ND	ND	ND
ethyl-tert-butyl-ether (ETBE; tert butyl ethyl ether) ¹³	μ g/L	ppb	none	ND	ND	ND	ND
methy-tert-butyl-ether (MTBE)	μ g/L	ppb	5 ^a	ND	ND	ND	ND
t-Butyl alcohol (TBA) ¹³	μ g/L	ppb	12 ^d	ND	ND	ND	ND ^g
tert-amyl-methyl-ether (TAME) ¹³	μ g/L	ppb	none	ND	ND	ND	ND
Volatile Organic Compounds (VOCs)							
benzene	μ g/L	ppb	1	ND	ND	ND	ND
bromobenzene	μ g/L	ppb	none	ND	ND	ND	ND
bromochloromethane	μ g/L	ppb	none	ND	ND	ND	ND
bromomethane (methyl bromide)	μ g/L	ppb	none	ND	ND	ND	ND
bromoethane (ethyl bromide)	μ g/L	ppb	none	na	ND**	na	ND ^h
n-butylbenzene	μ g/L	ppb	260 ^d	ND	ND	ND	ND
sec-butylbenze	μ g/L	ppb	260 ^d	ND	ND	ND	ND
tert-butylbenzene	μ g/L	ppb	260 ^d	ND	ND	ND	ND
carbon disulfide	μ g/L	ppb	160 ^d	ND	na	na	na
carbon tetrachloride	μ g/L	ppb	0.5	ND	ND	ND	ND
chlorobenzene (monochlorobenzene)	μ g/L	ppb	70	ND	ND	ND	ND
chloroethane	μ g/L	ppb	none	ND	ND	ND	ND
chloromethane (methyl chloride)	μ g/L	ppb	none	ND	ND	0.537	ND
2-chlorotoluene (o-chlorotoluene)	μ g/L	ppb	140 ^d	ND	ND	ND	ND
4-chlorotoluene (p-chlorotoluene)	μ g/L	ppb	140 ^d	ND	ND	ND	ND
dibromomethane (methylene dibromide)	μ g/L	ppb	none	ND	ND	ND	ND
1,2-dichlorobenzene(o-dichlorobenzene; 1,2-DCB)	μ g/L	ppb	600	ND	ND	ND	ND
1,3-dichlorobenzene (m-dichlorobenzene; 1,3-DCB)	μ g/L	ppb	600 ^d	ND	ND	ND	ND
1,4-dichlorobenzene (p-dichlorobenzene; 1,4-DCB)	μ g/L	ppb	5	ND	ND	0.20	ND
dichlorodifluoromethane (Freon 12) ¹³	μ g/L	ppb	1,000 ^d	ND	ND	ND	ND
1,1-dichloroethane	μ g/L	ppb	5	ND	ND	ND	ND
1,2-dichloroethane (1,2-DCA)	μ g/L	ppb	0.5	ND	ND	0.331	ND
1,1-dichloroethene (1,1-dichloroethylene; 1,1-DCE)	μ g/L	ppb	6	ND	ND	ND	ND
cis-1,2-dichloroethene (cis-1,2-dichloroethylene; cis-1,2-DCE)	μ g/L	ppb	6	ND	ND	ND	ND
trans-1,2-dichloroethene (trans-1,2-dichloroethylene; trans-1,2-DCE)	μ g/L	ppb	10	ND	ND	ND	ND
1,2-dichloropropane (1,2-DCP)	μ g/L	ppb	5	ND	ND	ND	ND
1,3-dichloropropane	μ g/L	ppb	none	ND	ND	ND	ND

Water Quality Comparison - Colorado River (CR), State Project Water (SPW), City of San Diego (SD)

Constituent	Metric Units	Units	Maximum Contaminant Level (MCL)	All Imported Water Sources^{10A,10B} (CR, SPW & Blended)	San Diego Source Water Yearly Average^{5A}	NCWRP Tertiary Effluent Average^{5B}	NCWRP UV + Peroxide Average⁶
Volatile Organic Compounds (VOCs) (cont'd)							
2,2-dichloropropane	μg/L	ppb	none	ND	ND	ND	ND
1,1-dichloropropene	μg/L	ppb	none	ND	ND	ND	ND
cis-1,3-dichloropropene	μg/L	ppb	0.5 ^c	ND	ND	ND	ND
trans-1,3-dichloropropene	μg/L	ppb	0.5 ^c	ND	ND	ND	ND
1,3-dichloropropene (1,3-dichloropropylene) Total	μg/L	ppb	0.5 ^c	ND	ND	ND	ND
ethylbenzene	μg/L	ppb	300	ND	ND	ND	ND
hexachlorobutadiene	μg/L	ppb	none	ND	ND	ND	ND ^h
isopropylbenzene	μg/L	ppb	770 ^d	ND	ND	ND	ND
p-isopropyltoluene (4-isopropyltoluene)	μg/L	ppb	none	ND	ND	ND ⁱ	ND
methylene chloride (dichloromethane; DCM)	μg/L	ppb	5	ND	ND	0.276	ND
methyl ethyl ketone (MEK; 2-butanone)	μg/L	ppb	none	ND	ND**	na	ND ^h
methyl isobutyl ketone (MIBK; 4-methyl-2-pentanone)	μg/L	ppb	120 ^d	ND	ND**	na	ND ^h
naphthalene	μg/L	ppb	17 ^d	ND	ND	ND	ND
n-propylbenzene	μg/L	ppb	260 ^d	ND	ND	ND	ND
styrene	μg/L	ppb	100	ND	ND	ND	ND
1,1,1,2-tetrachloroethane	μg/L	ppb	none	ND	ND	ND	ND
1,1,2,2-tetrachloroethane	μg/L	ppb	1	ND	ND	ND	ND
tetrachloroethene (tetrachloroethylene; PCE)	μg/L	ppb	5	ND	ND	ND	ND
toluene	μg/L	ppb	150	ND	ND	ND	ND
1,2,3-trichlorobenzene	μg/L	ppb	none	ND	ND	ND	ND
1,2,4-trichlorobenzene (1,2,4-TCB)	μg/L	ppb	70	ND	ND	ND	ND
1,1,1-trichloroethane (1,1,1-TCA)	μg/L	ppb	200	ND	ND	ND	ND
1,1,2-trichloroethane	μg/L	ppb	5	ND	ND	ND	ND
1,1,2-trichloroethene (trichloroethylene; 1,1,2-trichloroethylene; 1,1,2-TCE)	μg/L	ppb	5	ND	ND	ND	ND
trichlorofluoromethane (fluorotrichloromethane; freon 11)	μg/L	ppb	150	ND	ND	ND	ND
1,1,2-trichloro-1,2,2-trifluoroethane (1,1,2-trichlorotrifluoroethane; freon 113)	μg/L	ppb	1,200	ND	ND	ND	ND
1,2,3-Trichloropropane (1,2,3-TCP)	μg/L	ppb	.005 ^d	ND	ND**	na	ND ^h
1,2,4-trimethylbenzene	μg/L	ppb	330 ^d	ND	ND	ND	ND
1,3,5-trimethylbenzene	μg/L	ppb	330 ^d	ND	ND	ND	ND
vinyl chloride	μg/L	ppb	0.5	ND	ND	ND	ND
m-xylene	μg/L	ppb	1750 ^b	ND	ND	ND	ND
o-xylene	μg/L	ppb	1750 ^b	ND	ND	ND	ND
p-xylene	μg/L	ppb	1750 ^b	ND	ND	ND	ND

Water Quality Comparison - Colorado River (CR), State Project Water (SPW), City of San Diego (SD)

Constituent	Metric Units	Units	Maximum Contaminant Level (MCL)	All Imported Water Sources^{10A,10B} (CR, SPW & Blended)	San Diego Source Water Yearly Average^{5A}	NCWRP Tertiary Effluent Average^{5B}	NCWRP UV + Peroxide Average⁶
Volatile Organic Compounds (VOCs) (cont'd)							
xylenes (total)	μg/L	ppb	1750 ^b	ND	ND	ND	ND
Organochlorine pesticides							
Aldrin ¹²	μg/L	ppb	0.002 ^d	ND	ND	ND	ND
α-BHC ¹²	μg/L	ppb	0.015 ^d	ND	na	na	na
β-BHC ¹²	μg/L	ppb	0.025 ^d	ND	na	na	na
δ-BHC ¹²	μg/L	ppb	none	ND	na	ND	na
γ-BHC (Lindane) ¹²	μg/L	ppb	0.2	ND	ND	ND	ND
Chlordane ¹²	μg/L	ppb	0.1	ND	ND	ND	ND
Chlorothalonil (1,3-dicyano-2,4,5,6-tetrachlorobenzene)	μg/L	ppb	none	ND	na	na	na
4,4'-DDD (Dichlorodiphenyldichloroethane)	μg/L	ppb	none	ND	na	na	na
4,4'-DDE ¹²	μg/L	ppb	none	ND	na	na	na
4,4'-DDT ¹²	μg/L	ppb	none	ND	na	na	na
Dieldrin ¹²	μg/L	ppb	0.002 ^d	ND	ND	ND	ND
Endosulfan I ¹²	μg/L	ppb	none	ND	na	na	na
Endosulfan II ¹²	μg/L	ppb	none	ND	na	na	na
Endosulfan sulfate ¹²	μg/L	ppb	none	ND	na	na	na
Endrin	μg/L	ppb	2	ND	ND	ND	ND
Endrin aldehyde	μg/L	ppb	none	ND	na	na	na
Heptachlor ¹²	μg/L	ppb	0.01	ND	ND	ND	ND
Heptachlor epoxide ¹²	μg/L	ppb	0.01	ND	ND	ND	ND
Hexachlorobenzene	μg/L	ppb	1	ND	ND	ND	ND
Hexachlorocyclopentadiene	μg/L	ppb	50	ND	ND	ND	ND
Methoxychlor ¹²	μg/L	ppb	30	ND	ND	ND	ND
Propachlor	μg/L	ppb	90 ^d	ND	ND	ND	ND ^g
Toxaphene ¹²	μg/L	ppb	3	ND	ND	ND	ND
Polychlorinated biphenyls (PCB)12	μg/L	ppb	0.5	ND	ND	ND	ND
Trifluralin ¹²	μg/L	ppb	none	ND	ND	ND	ND ^g
Carbamates							
Aldicarb	μg/L	ppb	3 ^e (7 ^d)	ND	ND	ND	ND
Aldicarb Sulfone	μg/L	ppb	2 ^e	ND	ND	ND	ND
Aldicarb Sulfoxide	μg/L	ppb	4 ^e	ND	ND	ND	ND
Baygon (Propoxur)	μg/L	ppb	30 ^d	ND	ND	ND	ND
Carbofuran (Furadan)	μg/L	ppb	18	ND	ND	ND	ND
Carbaryl ¹²	μg/L	ppb	700 ^d	ND	ND	ND	ND

Water Quality Comparison - Colorado River (CR), State Project Water (SPW), City of San Diego (SD)

Constituent	Metric Units	Units	Maximum Contaminant Level (MCL)	All Imported Water Sources^{10A,10B} (CR, SPW & Blended)	San Diego Source Water Yearly Average^{5A}	NCWRP Tertiary Effluent Average^{5B}	NCWRP UV + Peroxide Average⁶
Carbamates (cont'd)							
3-Hydroxycarbofuran	μg/L	ppb	none	ND	ND	ND	ND
Methiocarb	μg/L	ppb	none	ND	ND	ND	ND
Methomyl¹²	μg/L	ppb	none	ND	ND	ND	ND
Oxamyl	μg/L	ppb	50	ND	ND	ND	ND
Organophosphorous Pesticides and Triazine Herbicides							
Alachlor¹²	μg/L	ppb	2	ND	ND	ND	ND
Atrazine¹²	μg/L	ppb	1	ND	ND	ND	ND
Bromacil	μg/L	ppb	none	ND	na	na	na
Butachlor	μg/L	ppb	none	ND	na	na	na
Diazinon	μg/L	ppb	6 ^d	ND	na	na	na
Dimethoate	μg/L	ppb	1 ^d	ND	na	na	na
Metolachlor	μg/L	ppb	none	ND	na	na	na
Metribuzin¹²	μg/L	ppb	none	ND	na	na	na
Molinate	μg/L	ppb	20	ND	ND	ND	ND
Prometon	μg/L	ppb	none	ND	na	na	na
Prometryn	μg/L	ppb	none	ND	na	na	na
Simazine	μg/L	ppb	4	ND	ND	ND	ND
Thiobencarb	μg/L	ppb	70 (1 ⁹)	ND	ND	ND	ND
Organochlorine Herbicides							
Acifluorfen	μg/L	ppb	none	ND	ND	ND	ND
Bentazon	μg/L	ppb	18	ND	ND	ND	ND
Chloramben	μg/L	ppb	none	na	ND	ND	ND ⁹
2,4-D	μg/L	ppb	70	ND	ND	ND	ND
2,4-DB	μg/L	ppb	none	ND	ND	ND	ND
3,5-Dichlorobenzoic Acid	μg/L	ppb	none	ND	ND	ND	ND
Dacthal (DCPA)	μg/L	ppb	none	ND	ND**	na	na
Dalapon	μg/L	ppb	200	ND	ND**	ND	ND
Dicamba	μg/L	ppb	none	ND	ND	ND	ND
Dichlorprop	μg/L	ppb	none	ND	ND	ND	ND
Dinoseb	μg/L	ppb	7	ND	ND	ND	ND
MCPA	μg/L	ppb	none	na	ND	ND	ND ⁹
MCPP	μg/L	ppb	none	na	ND	ND	ND ⁹
Pentachlorophenol¹²	μg/L	ppb	1	ND	ND	ND	ND
Picloram	μg/L	ppb	500	ND	ND	ND	ND

Water Quality Comparison - Colorado River (CR), State Project Water (SPW), City of San Diego (SD)

Constituent	Metric Units	Units	Maximum Contaminant Level (MCL)	All Imported Water Sources^{10A,10B} (CR, SPW & Blended)	San Diego Source Water Yearly Average^{5A}	NCWRP Tertiary Effluent Average^{5B}	NCWRP UV + Peroxide Average⁶
Organochlorine Herbicides (cont'd)							
2,4,5-TP (Silvex)	μg/L	ppb	50	ND	ND	ND	ND
2,4,5-T	μg/L	ppb	none	ND	ND	ND	ND
Fumigants							
Dibromochloropropane (1,2-dibromo-3-chloropropane; DBCP)	μg/L	ppb	0.2	ND	ND	ND	ND
Ethylene dibromide (EDB; 1,2-dibromoethane) ¹²	μg/L	ppb	0.05	ND	ND	ND	ND
Semi-Volatile Organic Compounds (SVOCs)							
Benzo(a)pyrene ¹²	μg/L	ppb	0.2	ND	ND	ND	ND
Di(2-ethylhexyl)adipate (Bis(2-ethylhexyl)adipate)	μg/L	ppb	400	ND	ND	ND	ND
Di(2-ethylhexyl)phthalate (Bis(2-ethylhexyl)phthalate; DEHP) ¹²	μg/L	ppb	4	ND	ND	ND	ND
Trihalomethanes							
Chloroform (trichloromethane) ¹²	μg/L	ppb	none	na	0.81	1.34	1.9
Bromodichloromethane (BDCM)	μg/L	ppb	none	na	0.67	0.414	0.6
Bromoform (tribromomethane)	μg/L	ppb	none	na	0.113	ND	ND
Chlorodibromomethane (Dibromochloromethane)	μg/L	ppb	none	na	0.20	0.36	ND
Total THMs	μg/L	ppb	80	na	1.80	2.11	2.4 ^{k,p}
Haloacetic acids (HAAs)							
Dibromoacetic acid	μg/L	ppb	none	na	na	ND	ND ^g
Dichloroacetic acid	μg/L	ppb	none	na	na	ND	ND ^g
monobromoacetic acid	μg/L	ppb	none	na	na	ND	ND ^g
monochloroacetic acid	μg/L	ppb	none	na	na	ND	ND ^g
trichloroacetic acid	μg/L	ppb	none	na	na	2.60	ND ^g
HAA5 (Total HAAs)	μg/L	ppb	60	na	na	2.60	ND ^g
Miscellaneous							
Diquat	μg/L	ppb	20	ND	ND**	ND	ND
Diuron	μg/L	ppb	none	ND	na	na	na
Endothall	μg/L	ppb	100	ND	ND**	na	ND ^h
Glyphosate	μg/L	ppb	700	ND	ND	na	ND ^h
Dioxin (2,3,7,8-TCDD) ¹²	μg/L	ppb	0.00003	ND	ND**	na	ND ^h
1,4-Dioxane	μg/L	ppb	3 ^d	ND	ND**	na	ND ^{h,i}
2-methylisoborneol(MIB)	μg/L	ppb	none	ND	4.7	na	na
4-isopropyltoluene (Cymene)	μg/L	ppb	none	na	ND	na	na
4-nitrophenol	μg/L	ppb	none	na	ND	ND	ND ^g

Water Quality Comparison - Colorado River (CR), State Project Water (SPW), City of San Diego (SD)

Constituent	Metric Units	Units	Maximum Contaminant Level (MCL)	All Imported Water Sources^{10A,10B} (CR, SPW & Blended)	San Diego Source Water Yearly Average^{5A}	NCWRP Tertiary Effluent Average^{5B}	NCWRP UV + Peroxide Average⁶
Miscellaneous (con'td)							
dibenzo(a,h)anthracene	μg/L	ppb	none	na	ND	na	na
Diethyl phthalate (DEP)¹²	μg/L	ppb	none	na	ND	ND	ND ^g
Dimethyl phthalate	μg/L	ppb	none	na	0.068	ND	ND ^g
Di-n-butyl phthalate (DBP)¹²	μg/L	ppb	none	na	0.103	ND	ND ^g
Acenaphthylene	μg/L	ppb	none	na	ND	ND	ND ^g
Anthracene	μg/L	ppb	none	na	ND	ND	ND ^g
Benzo(A)anthracene	μg/L	ppb	none	na	ND	ND	ND ^g
Benzo(G,H,I)perylene	μg/L	ppb	none	na	ND	ND	ND ^g
Benzo(b)fluoranthene	μg/L	ppb	none	na	ND	ND	ND ^g
Benzo(K)fluoranthene	μg/L	ppb	none	na	ND	ND	ND ^g
Butyl benzyl phthalate¹²	μg/L	ppb	none	na	ND	ND	ND ^g
Chrysene	μg/L	ppb	none	na	ND	ND	ND ^g
Fluorene	μg/L	ppb	none	na	ND	ND	ND ^g
Geosmin	μg/L	ppb	none	na	6.25	na	na
Indeno(1,2,3-CD)pyrene	μg/L	ppb	none	na	ND	ND	ND ^g
N-nitroso dimethylamine (NDMA)	ng/L	ppt	10 ^d	na	ND**	na	ND ^{h, i}
Ortho Phosphates	mg/L	ppm	none	na	ND ⁱ	5.34	ND ^g
Phenanthrene	μg/L	ppb	none	na	ND	ND	ND ^g
Pyrene	μg/L	ppb	none	na	ND	ND	ND ^g
Paraquat	μg/L	ppb	none	na	ND**	ND	ND

Water Quality Comparison - Colorado River (CR), State Project Water (SPW), City of San Diego (SD)

Constituent	Metric Units	Units	Maximum Contaminant Level (MCL)	All Imported Water Sources^{10A,10B} (CR, SPW & Blended)	San Diego Source Water Yearly Average^{5A}	NCWRP Tertiary Effluent Average^{5B}	NCWRP UV + Peroxide Average⁶
Unregulated Contaminant Monitoring Rule (UCMR)-List 1							
DCPA mono and di-acid degradate	μg/L	ppb	none	ND	ND**	na	ND ^h
MTBE	μg/L	ppb	5 ^a	na	ND	na	ND ^h
Nitrobenzene ¹⁴	μg/L	ppb	none	na	na	na	na
2,4-dinitrotoluene	μg/L	ppb	none	ND	na	na	na
2,6-dinitrotoluene	μg/L	ppb	none	ND	na	na	na
Acetochlor¹²	μg/L	ppb	none	ND	na	na	na
EPTC	μg/L	ppb	none	ND	na	na	na
DDE¹²	μg/L	ppb	none	ND	na	na	na
Molinate	μg/L	ppb	20	ND	ND	ND	ND ^h
Terbacil	μg/L	ppb	none	ND	na	na	na
Perchlorate	μg/L	ppb	6 ^d	na	ND	na	ND ^h
UCMR-List 2							
1,2-Diphenylhydrazine	μg/L	ppb	none	ND	na	na	na
Diazinon	μg/L	ppb	6 ^d	ND	na	na	na
Disulfoton	μg/L	ppb	none	ND	na	na	na
Fonofos	μg/L	ppb	none	ND	na	na	na
Nitrobenzene ¹⁴	μg/L	ppb	none	ND	na	na	na
Prometon	μg/L	ppb	none	ND	na	na	na
Terbufos	μg/L	ppb	none	ND	na	na	na
2,4,6-Trichlorophenol	μg/L	ppb	none	ND	na	na	na
2,4-Dichlorophenol	μg/L	ppb	none	ND	na	na	na
2,4-Dinitrophenol	μg/L	ppb	none	ND	na	na	na
2-Methyl-phenol	μg/L	ppb	none	ND	na	na	na
Alachlor ESA ¹⁵	TBD		none	na	na	na	na
RDX ¹⁵	μg/L	ppb	0.3 ^d	na	na	na	na
Diuron	μg/L	ppb	none	ND	na	na	na
Linuron¹²	μg/L	ppb	none	ND	na	na	na
UCMR-List 3							
Lead-210	TBD		none	na	na	na	na
Polonium-210	TBD		none	na	na	na	na

Water Quality Comparison - Colorado River (CR), State Project Water (SPW), City of San Diego (SD)

Constituent	Metric Units	Units	Maximum Contaminant Level (MCL)		San Diego Source Water Average SNWA ¹⁶	NCWRP Tertiary Effluent Average SNWA ¹⁷	NCWRP UV + Peroxide Average SNWA ¹⁸
Endocrine Disrupting Compounds (EDCs), Pharmaceuticals and Personal Care Products (PPCPs)							
Hydrocodone	ng/L	ppt	none		<1.0	84	<1.0
Trimethoprim	ng/L	ppt	none		<1.0	365	<1.0
Acetaminophen	ng/L	ppt	none		<1.0	<1.0 ⁿ	<1.0
Caffeine	ng/L	ppt	none		<10	<10	<10
Erythromycin-H ₂ O	ng/L	ppt	none		<1.0	323	<1.0
Sulfamethoxazole	ng/L	ppt	none		3.0	788	<1.0
Fluoxetine	ng/L	ppt	none		<1.0	41	<1.0
Pentoxifylline	ng/L	ppt	none		<1.0	<1.0	<1.0
Meprobamate	ng/L	ppt	none		4	262	<1.0
Dilantin	ng/L	ppt	none		<1.0 ⁿ	125	<1.0
TCEP	ng/L	ppt	none		<10	289	<10
Carbamazepine	ng/L	ppt	none		<1.0 ⁿ	275	<1.0
DEET	ng/L	ppt	none		6.8	270	<1.0 ^l
Atrazine	ng/L	ppt	1		2.0	1	<1.0
Diazepam	ng/L	ppt	none		<1.0	2.9	<1.0
Oxybenzone	ng/L	ppt	none		<1.0	<1.0 ⁿ	<1.0 ^l
Estriol¹¹	ng/L	ppt	none		<5.0	<5.0	<5.0
Ethinylestradiol¹¹	ng/L	ppt	none		<1.0	<1.0	<1.0
Estrone¹¹	ng/L	ppt	none		<1.0	12	<1.0
Estradiol¹¹	ng/L	ppt	none		<1.0	<1.0	<1.0
Progesterone¹¹	ng/L	ppt	none		<1.0	<1.0	<1.0
Testosterone	ng/L	ppt	none		<1.0	<1.0	<1.0
Androstenedione	ng/L	ppt	none		<1.0	4.7	<1.0
Iopromide	ng/L	ppt	none		<1.0 ⁿ	543	<1.0
naproxen	ng/L	ppt	none		<1.0	36	<1.0
Ibuprofen	ng/L	ppt	none		1.3	26	<1.0
Diclofenac	ng/L	ppt	none		<1.0	62	<1.0
Triclosan	ng/L	ppt	none		na ⁷	na ⁷	<1.0 ^m
Gemfibrozil	ng/L	ppt	none		<1.0	184	<1.0

Water Quality Comparison - Colorado River (CR), State Project Water (SPW), City of San Diego (SD)

End Notes
<p> na = Not Analyzed or Not Available. ND = Not Detected. LE = Laboratory Error. TBD = To Be Determined. MFL = million fibers per liter. mg/L = milligrams per liter. µg/L = micrograms per liter. ng/L = nanograms per liter. µmho/cm = micromhos per centimeter. NTU = nephelometric turbidity unit. CU = color unit. pCi/L = picocuries per liter. ppm = parts per million. ppb = parts per trillion. ppt = parts per trillion. </p> <p> 1 = Primary drinking water standards; lowest standard is used from the United States Environmental Protection Agency (EPA) or California Department of Health Services (DHS). 2 = CR and SPW general mineral, physical analysis and trace metals data provided by Metropolitan Water District of Southern California (MWD); all data reported are annual arithmetic averages based on analysis of samples collected during fiscal year 2004-2005. 3 = Sample data provided by Montgomery Watson Harza Laboratory (MWH) or their contract laboratory. 4 = Average yearly data for calendar year 2005 provided by the City of San Diego Water Quality Laboratory (WQL) or their contract laboratory. 5A = Average yearly data for calendar year 2005 provided by the WQL or their contract laboratory, except where noted; 5B = WQL average data of three samples collected 3/25/2005, 4/13/2005 and between 7/14/2005 - 7/19/2005. 7 = No data available due to contaminated samples. 6 = Average of data obtained by the WQL and MWH for three sample dates, unless otherwise noted. 8 = MWD radiological samples collected during the four quarters of fiscal year 2002-2003. 9 = One radiological sample each from Lake Murray and Lake Miramar analyzed by MWH; sample date 4/13/2005. 10A = MWD: VOC data are averages for first three quarters of 2005 (fourth quarter data na at this time) of all source and treated water; 10B = MWD: pesticide, herbicide, SVOC and UCMR data are averages from source and treated water samples collected in August, 2004; 2005 data na at time of this comparison. 11 = Estrogens 12 = Compound/element in red is a suspected endocrine disruptor; 13 = DHS unregulated VOCs (April 11, 2005) 14 = Nitrobenzene is on List 1 and 2 Federal UCMR Contaminants with two different reporting levels and analytical method requirements. 15 = Monitoring will be required when List 3 requirements are finalized. 16 = Average of data provided by the Southern Nevada Water Authority Laboratory (SNWA) from analysis on samples collected on 3/25/05 and 04/13/2005. 17 = Average of data provided by the SNWA from analysis of samples collected on 4/13/2005 from Lake Murray and Lake Miramar. 18 = Average of data provided by the SNWA from analysis of samples collected on 4/13/2005 and 12/30/2005. </p>
End Notes
<p> A = Secondary drinking water standard. b = MCL for xylene is either for a single isomer or for the sum of the three isomers. c = MCL for 1,3-dichloropropene is either for a single isomer or for the sum of the cis & trans isomers. d = Notification level. NOTE: action levels became notification levels in 2005 and some action levels have been archived but may be used by agencies per DHS. e = Effective date of January 1, 1993 has been postponed, Federal Register, May 27, 1992, pending revised MCL. f = MCL is for radium-226 & -228 combined. g = WQL data only, based on analysis of one sample, sample date 4/13/2005. h = MWH data only, based on average of two samples dated 4/13/2005 and 12/30/2005. j = While data is greater than the San Diego Source Water Average, this analyte does not have a notification level or MCL. k = Analyte not required analysis for source water. l = Analyte detected in one or more samples, however, the average of the data is below the method detection limit and thus ND per state reporting protocols. m = Data based on one sample, sample date 12/30/2005. n = Analyte detected in one or more samples, however, the average of the data is below the method detection limit and thus <1 per state reporting protocols. p = While data is greater than the San Diego Source Water Average, it is below the MCL considered a human health concern. ** = No City of San Diego data available, average value taken from MWH's analysis of two samples, one each from Lake Murray and Lake Miramar, sample date 4/13/2005. </p>