

GREATER GOLDEN HILL COMMUNITY PLAN
SAN DIEGO, CALIFORNIA

MAP UNITS

- Qop Old paralic deposits, undivided (late to middle Pleistocene)
- Qop6
- Qvoa Very old alluvial flood-plain deposits, undivided (middle to early Pleistocene)
- Qvop Very old paralic deposits, undivided (middle to early Pleistocene)
- Qvop6
- Qvop8
- Qvop9
- } Very Old Terrace Deposits
- }
- San Diego Formation (early Pleistocene and late Pliocene)
- Tsd - undivided
- Tsdcg - transitional marine and nonmarine pebble and cobble conglomerate
- Tsdss - marine sandstone



0' 1,000' 2,000' 3,000' 4,000'
SCALE 1"=2,000'

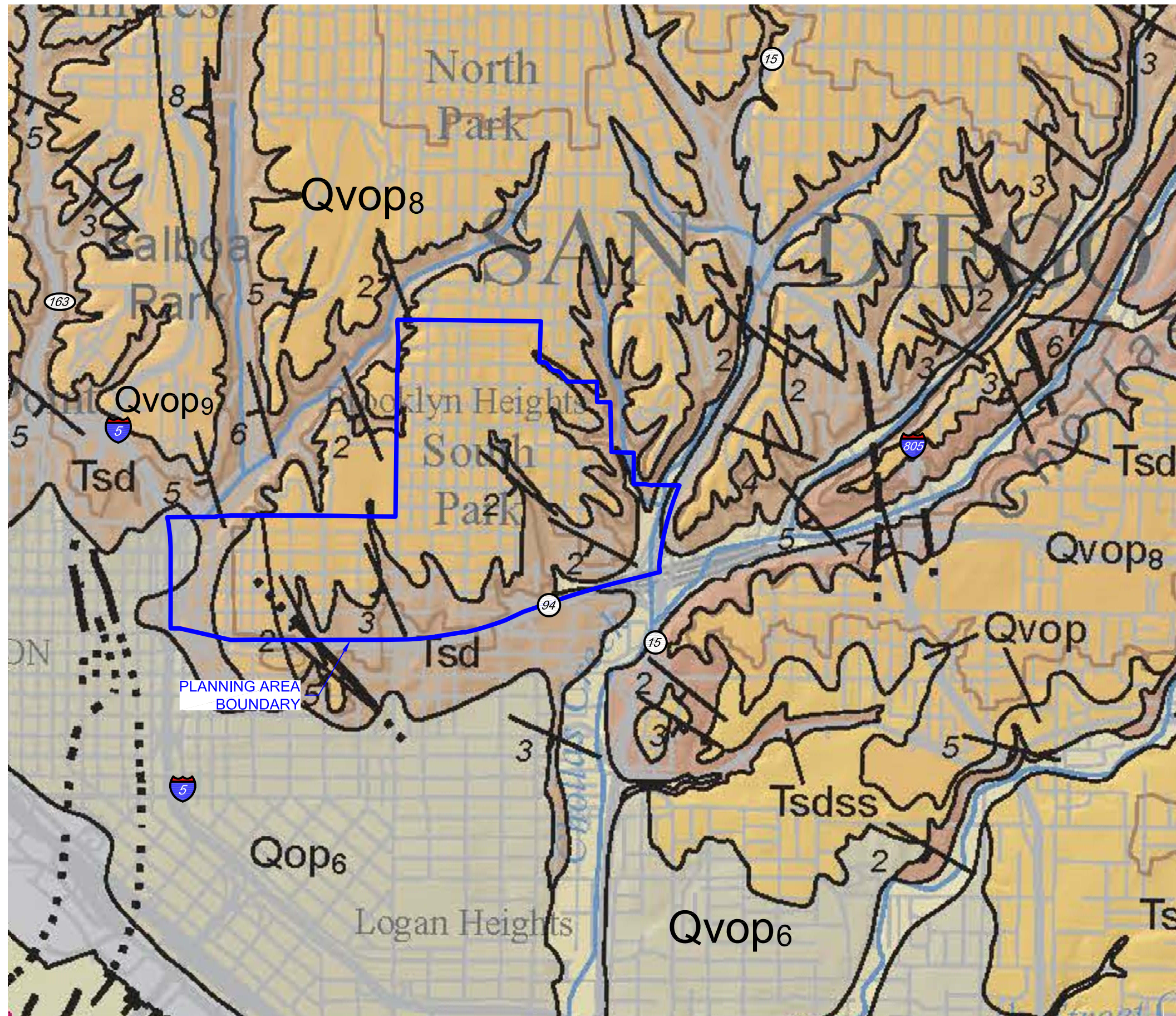

GEOLOGIC MAP



GEOCON
INCORPORATED
 GEOTECHNICAL ■ ENVIRONMENTAL ■ MATERIALS
 6960 FLANDERS DRIVE - SAN DIEGO, CALIFORNIA 92121 - 2974
 PHONE 858 558-6900 - FAX 858 558-6159
 PROJECT NO. G1737 - 42 - 01
 FIGURE 7
 DATE 06 - 10 - 2015

UPTOWN COMMUNITY PLAN
SAN DIEGO, CALIFORNIA



LEGEND

Geologic Hazard Categories





FAULT ZONES

-  11 Active, Alquist-Priolo Earthquake Fault Zone
-  12 Potentially Active, Inactive, Presumed Inactive, or Activity Unknown
-  13 Downtown special fault zone

LIQUEFACTION

-  31 High Potential -- shallow groundwater major drainages, hydraulic fills
-  32 Low Potential -- fluctuating groundwater minor drainages

OTHER TERRAIN

-  51 Level mesas -- underlain by terrace deposits and bedrock nominal risk
-  52 Other level areas, gently sloping to steep terrain, favorable geologic structure, Low risk
-  53 Level or sloping terrain, unfavorable geologic structure, Low to moderate risk
-  54 Steeply sloping terrain, unfavorable or fault controlled geologic structure, Moderate risk
-  55 Modified terrain (graded sites) Nominal risk

Water (Bays and Lakes)



FAULTS

-  Fault
-  Inferred Fault
-  Concealed Fault
-  Shear Zone

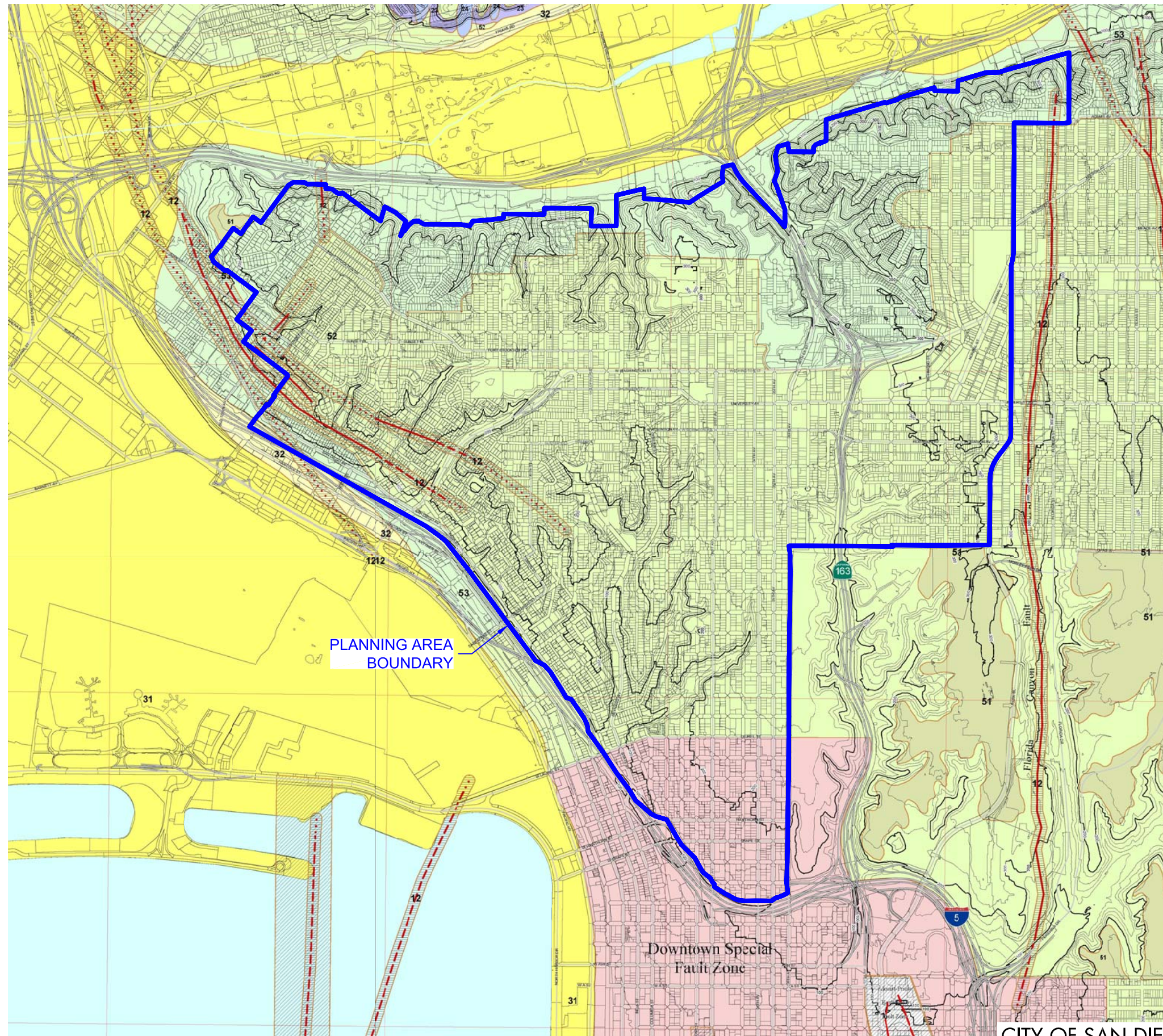

PLANNING AREA
BOUNDARY

Downtown Special
Fault Zone

CITY OF SAN DIEGO SEISMIC HAZARD MAP

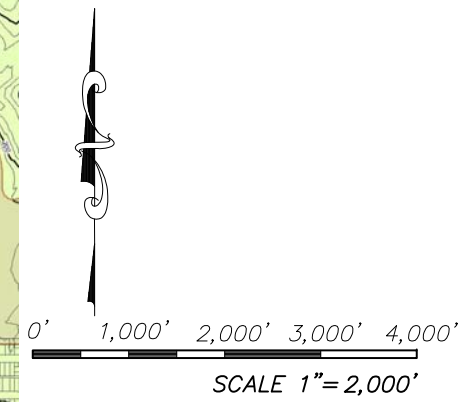

GEOCON
INCORPORATED





GEOTECHNICAL ■ ENVIRONMENTAL ■ MATERIALS
6960 FLANDERS DRIVE - SAN DIEGO, CALIFORNIA 92121 - 2974
PHONE 858 558-6900 - FAX 858 558-6159
PROJECT NO. G1737 - 42 - 01
FIGURE 8
DATE 06 - 10 - 2015

NORTH PARK COMMUNITY PLAN SAN DIEGO, CALIFORNIA



LEGEND

Geologic Hazard Categories





FAULT ZONES

-  11 Active, Alquist-Priolo Earthquake Fault Zone
-  12 Potentially Active, Inactive, Presumed Inactive, or Activity Unknown
-  13 Downtown special fault zone

LIQUEFACTION

-  31 High Potential -- shallow groundwater major drainages, hydraulic fills
-  32 Low Potential -- fluctuating groundwater minor drainages

OTHER TERRAIN

-  51 Level mesas -- underlain by terrace deposits and bedrock nominal risk
-  52 Other level areas, gently sloping to steep terrain, favorable geologic structure, Low risk
-  53 Level or sloping terrain, unfavorable geologic structure, Low to moderate risk
-  54 Steeply sloping terrain, unfavorable or fault controlled geologic structure, Moderate risk
-  55 Modified terrain (graded sites) Nominal risk

Water (Bays and Lakes)



FAULTS

-  Fault
-  Inferred Fault
-  Concealed Fault
-  Shear Zone

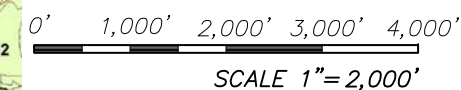
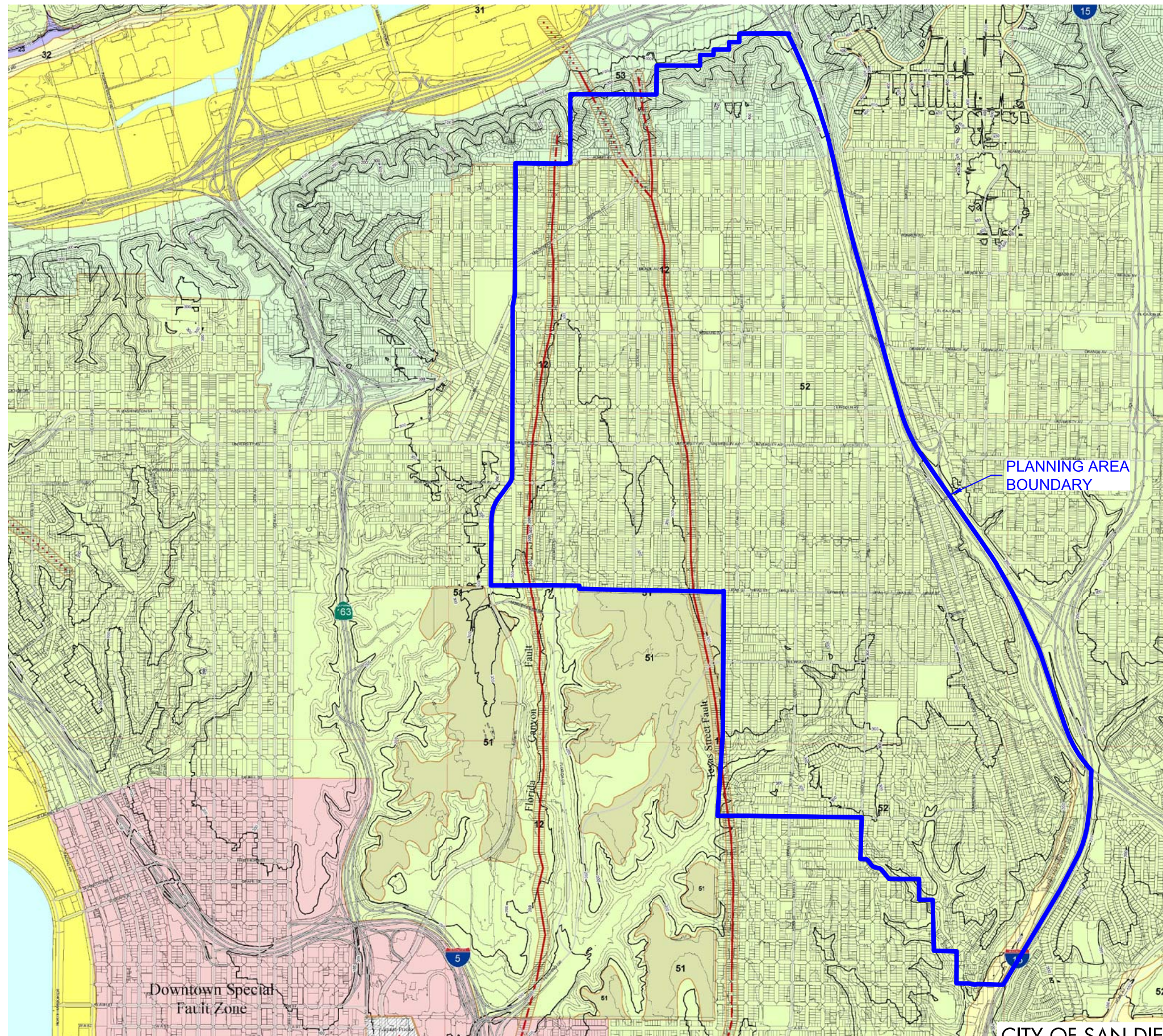

GEOCON
INCORPORATED

GEOTECHNICAL ■ ENVIRONMENTAL ■ MATERIALS
6960 FLANDERS DRIVE - SAN DIEGO, CALIFORNIA 92121 - 2974
PHONE 858 558-6900 - FAX 858 558-6159
PROJECT NO. G1737 - 42 - 01
FIGURE 9
DATE 06 - 10 - 2015



CITY OF SAN DIEGO SEISMIC HAZARD MAP

GREATER GOLDEN HILL COMMUNITY PLAN
SAN DIEGO, CALIFORNIA



LEGEND

Geologic Hazard Categories





FAULT ZONES

-  11 Active, Alquist-Priolo Earthquake Fault Zone
-  12 Potentially Active, Inactive, Presumed Inactive, or Activity Unknown
-  13 Downtown special fault zone

LIQUEFACTION

-  31 High Potential -- shallow groundwater major drainages, hydraulic fills
-  32 Low Potential -- fluctuating groundwater minor drainages

OTHER TERRAIN

-  51 Level mesas -- underlain by terrace deposits and bedrock nominal risk
-  52 Other level areas, gently sloping to steep terrain, favorable geologic structure, Low risk
-  53 Level or sloping terrain, unfavorable geologic structure, Low to moderate risk
-  54 Steeply sloping terrain, unfavorable or fault controlled geologic structure, Moderate risk
-  55 Modified terrain (graded sites) Nominal risk

Water (Bays and Lakes)

-  Water (Bays and Lakes)

FAULTS

-  Fault
-  Inferred Fault
-  Concealed Fault
-  Shear Zone

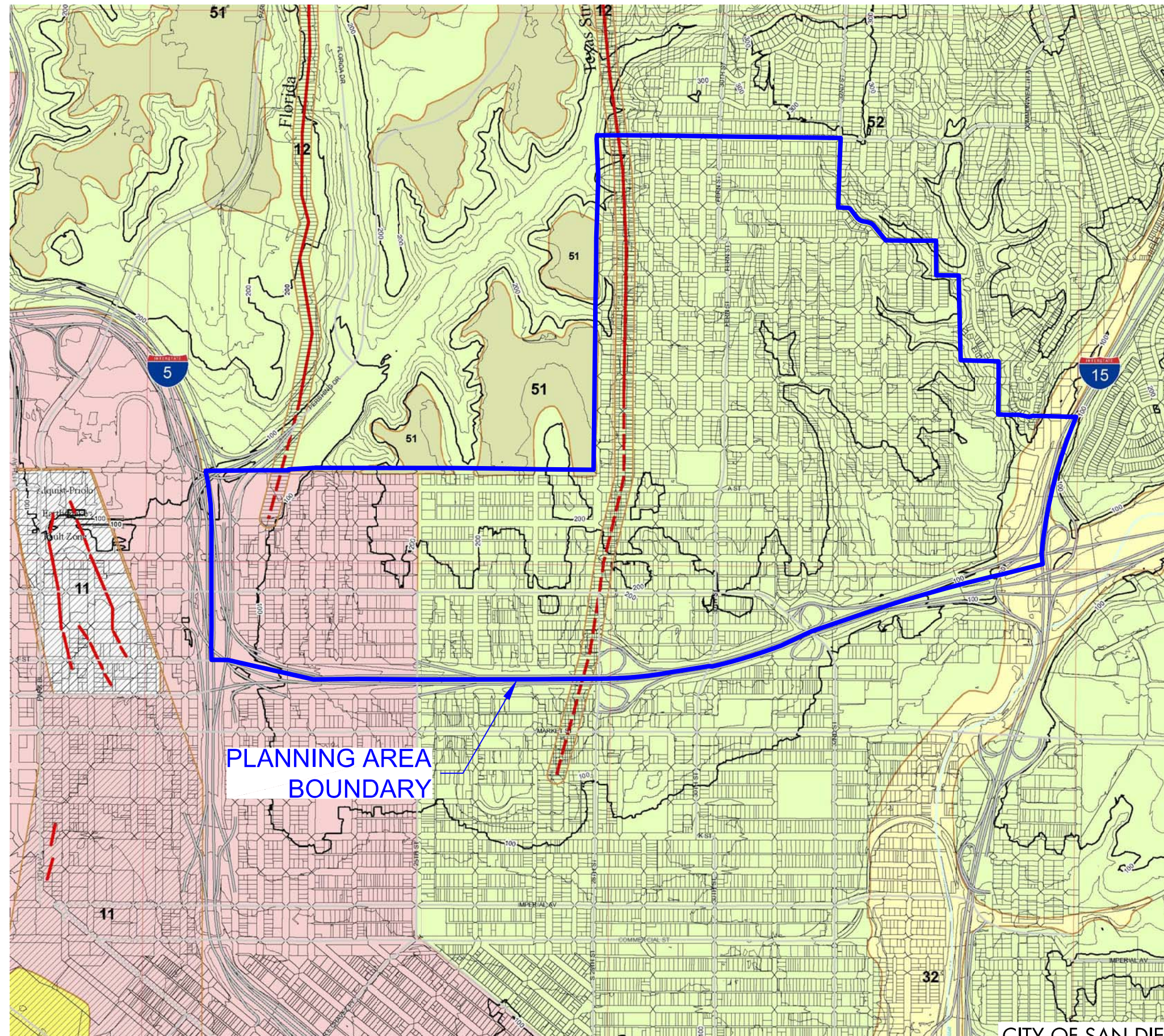

PLANNING AREA
BOUNDARY

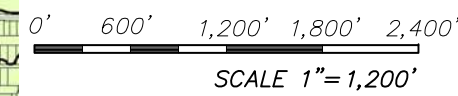

GEOCON
INCORPORATED



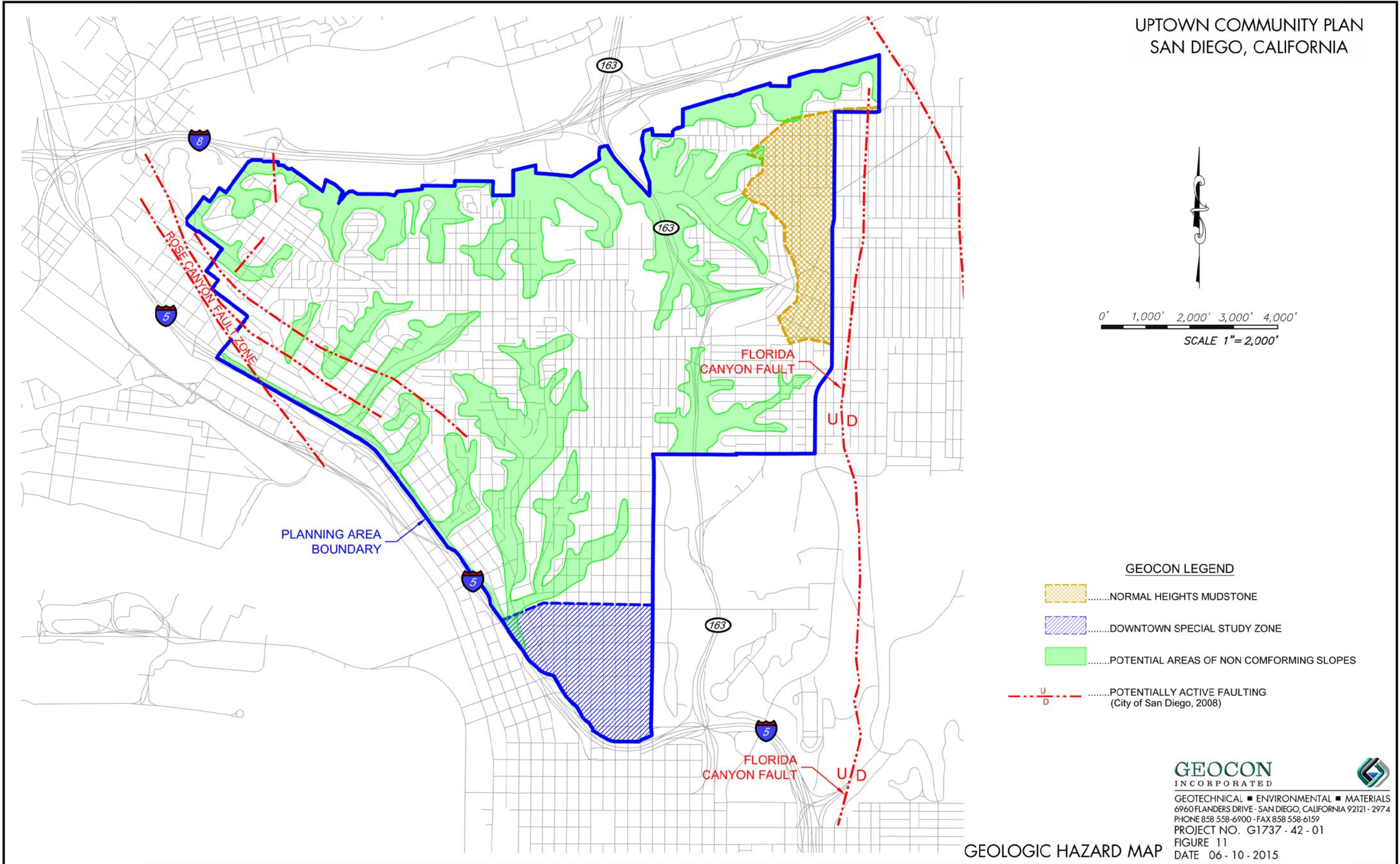

GEOTECHNICAL ■ ENVIRONMENTAL ■ MATERIALS
6960 FLANDERS DRIVE - SAN DIEGO, CALIFORNIA 92121 - 2974
PHONE 858 558-6900 - FAX 858 558-6159
PROJECT NO. G1737 - 42 - 01
FIGURE 10
DATE 06 - 10 - 2015

CITY OF SAN DIEGO SEISMIC HAZARD MAP

UPTOWN COMMUNITY PLAN
SAN DIEGO, CALIFORNIA



GEOCON LEGEND

- NORMAL HEIGHTS MUDSTONE
- DOWNTOWN SPECIAL STUDY ZONE
- POTENTIAL AREAS OF NON CONFORMING SLOPES
- POTENTIALLY ACTIVE FAULTING (City of San Diego, 2008)

GEOCON
INCORPORATED

GEOTECHNICAL ■ ENVIRONMENTAL ■ MATERIALS
6960 FLANDERS DRIVE - SAN DIEGO, CALIFORNIA 92121 - 2974
PHONE 858 558-6900 - FAX 858 558-6159
PROJECT NO. G1737 - 42 - 01
FIGURE 11
DATE 06 - 10 - 2015

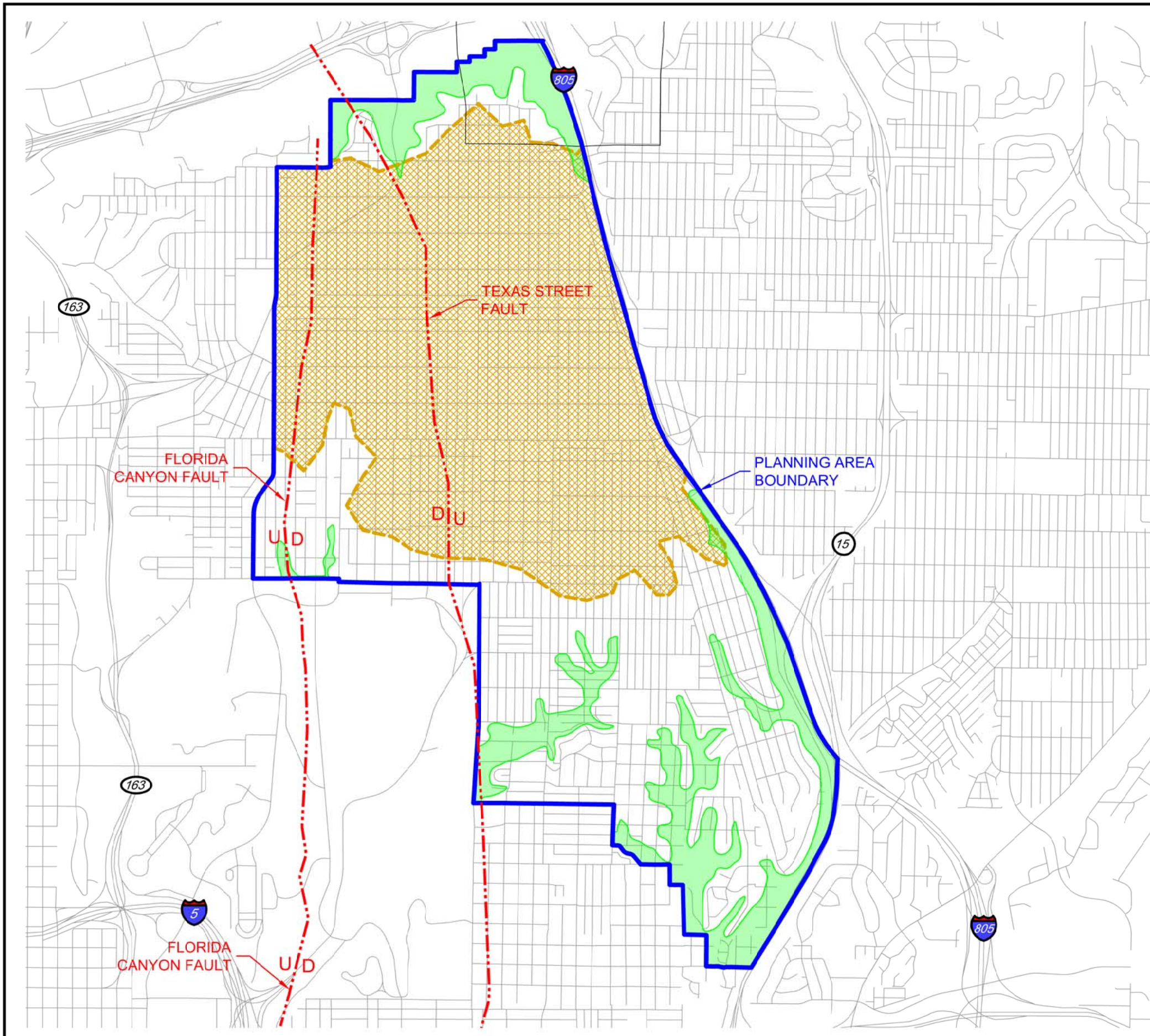

GEOLOGIC HAZARD MAP

NORTH PARK COMMUNITY PLAN
SAN DIEGO, CALIFORNIA



0' 1,000' 2,000' 3,000' 4,000'
SCALE 1"=2,000'

GEOCON LEGEND

- NORMAL HEIGHTS MUDSTONE
- POTENTIAL AREAS OF NON COMFORMING SLOPES
- POTENTIALLY ACTIVE FAULTING
(City of San Diego, 2008)

GEOCON
INCORPORATED



GEOTECHNICAL ■ ENVIRONMENTAL ■ MATERIALS
6960 FLANDERS DRIVE · SAN DIEGO, CALIFORNIA 92121 · 297.4
PHONE 858 558-6900 · FAX 858 558-6159
PROJECT NO. G1737 - 42 - 01
FIGURE 12
DATE 06 - 10 - 2015

GEOLOGIC HAZARD MAP

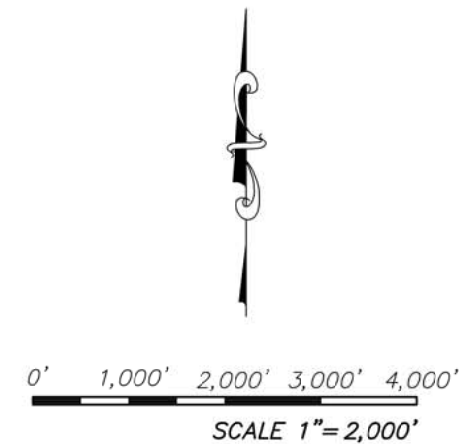
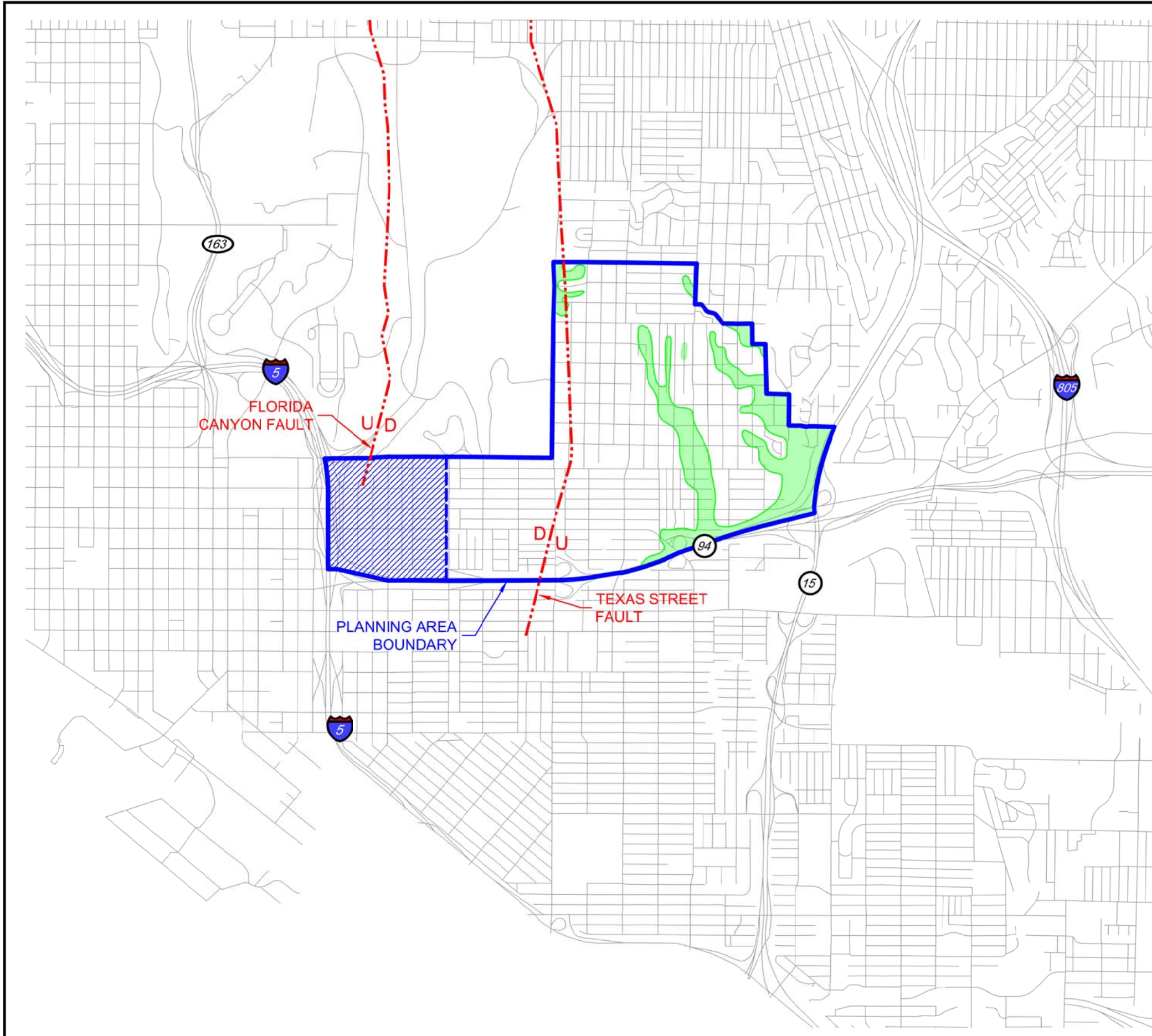
GREATER GOLDEN HILL COMMUNITY PLAN
SAN DIEGO, CALIFORNIA

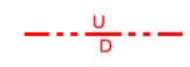

GEOCON LEGEND

- DOWNTOWN SPECIAL STUDY ZONE
- POTENTIAL AREAS OF NON CONFORMING SLOPES
- POTENTIALLY ACTIVE FAULTING
(City of San Diego, 2008)

GEOCON
INCORPORATED

GEOTECHNICAL ■ ENVIRONMENTAL ■ MATERIALS
6960 FLANDERS DRIVE · SAN DIEGO, CALIFORNIA 92121 · 297.4
PHONE 858 558-6900 · FAX 858 558-6159
PROJECT NO. G1737 - 42 - 01
FIGURE 13
DATE 06 - 10 - 2015

GEOLOGIC HAZARD MAP

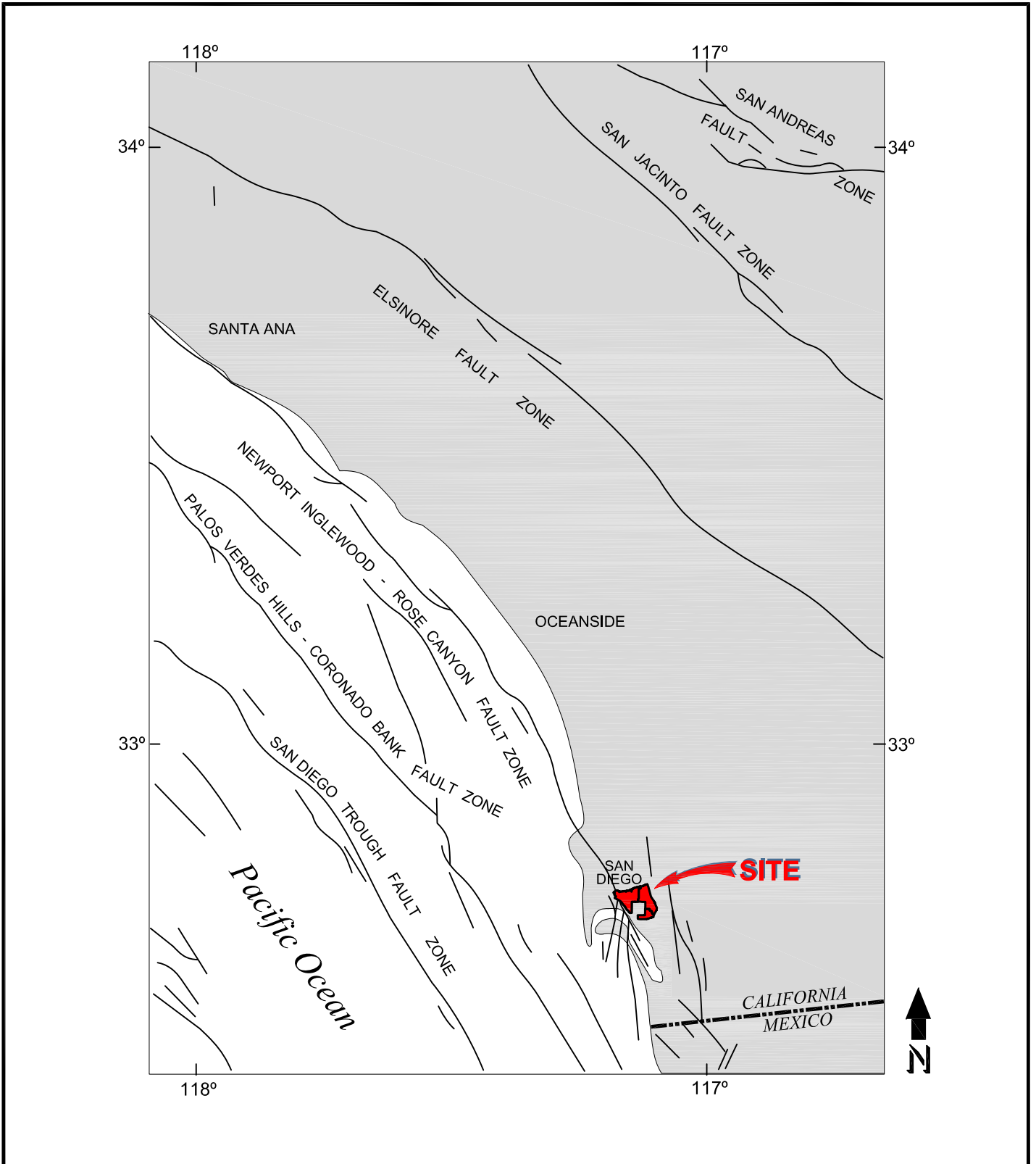

GEOCON
INCORPORATED

GEOTECHNICAL ■ ENVIRONMENTAL ■ MATERIALS
6960 FLANDERS DRIVE - SAN DIEGO, CALIFORNIA 92121 - 2974
PHONE 858 558-6900 - FAX 858 558-6159

TR / AML		DSK/GTYPD
----------	--	-----------

REGIONAL FAULT MAP

UPTOWN, NORTH PARK, AND GREATER
GOLDEN HILL COMMUNITY PLAN
SAN DIEGO, CALIFORNIA

DATE 06 - 10 - 2015	PROJECT NO. G1737 - 42 - 01	FIG. 14
---------------------	-----------------------------	---------