



SAN DIEGO POLICE
FORENSIC SCIENCE SECTION



Crime Scene Reconstruction Team Manual

ARCHIVED

Issuing Authority Frank Healy, Quality Manager
Approved July 17, 2017
Printed Copies are Not Controlled

1.0 PROGRAM STRUCTURE

1.1 Program Goal

A goal of this program is to provide the best service possible at crime scenes, play to the strengths of the criminalists themselves, and move toward a program where all criminalists can do all aspects of reconstruction. It will provide a back-up criminalist, as well as technical assistance when necessary. It will also ensure that each scene is handled by personnel most suited to it. This program operates under the premise that every criminalist on call is competent to handle bloodstain pattern reconstruction, trajectory reconstruction, and to search for biological fluids at crime scenes.

1.2 Program Structure

- For the purposes of the on-call schedule, criminalists are divided into two categories: primary and secondary. All criminalists will be expected to respond to any type of scene to include homicides, officer involved shooting (OIS) scenes, and sexual assaults.
- All criminalists on call will be capable of performing bloodstain pattern reconstruction, trajectory reconstruction, and search for biological fluids.
- The on-call schedule will be created on a yearly basis. The final schedule will be put together by the crime scene reconstruction supervisor, with individual preferences in mind.
- Each week there will be a criminalist who is first-up (primary) and one who is second-up (back-up). The schedule will be done in such a manner that all criminalists will have roughly the same number of primary and back-up weeks. In other words, roughly half of a person's on-call weeks will be as a primary, half as a back-up.
- When a criminalist is the primary, he/she will receive the call-out, regardless of type. It will fall to that criminalist to determine whether he/she should take that scene. There are some rules to this process.
- The primary criminalist will be responsible for handling the scene, regardless of what type of evidence is present.
- If the scene is complicated, and there is 1) a lot of work to do, 2) complicated trajectories and a significant amount of blood, or 3) complicated bloodspatter with significant trajectories, both criminalists should respond to the scene to handle it in an efficient and qualified manner. In this instance, the primary criminalist will typically be responsible for writing the report. If the primary criminalist is unable to write the report for the scene, the secondary criminalist will become responsible for the report. This is an issue that can be

worked out in advance; however, and if a decision cannot be reached, involve the supervisor on-call.

- At any time, any type of scene may be complicated. The back-up must be available to assist irrespective of the type of scene.
- In the case of two scenes in a row, or at the same time, one criminalist will handle one, the second the other. If more assistance is required, or if both criminalists have responded to a scene, involve the supervisor on-call to locate an authorized criminalist to respond as needed.
- If the scene involves a complicated trajectory or a complicated bloodspatter reconstruction that the primary criminalist is not comfortable with, that criminalist will call the back-up to assist, and the scene will be used as a training experience. It will be worked out between the primary and back-up who should write the report in that instance. If a decision cannot be reached, involve the supervisor on-call.

1.3 Personnel Rotation

Call-out personnel will rotate on Tuesday mornings along with the Homicide and Crime Scene Unit personnel. This rotation will take place at 0730 hours. The team member on call will have a mobile phone and the crime scene van or SUV assigned to him or her.

1.4 Compensation

All call-out team members will receive a 25% increase in pay for the weeks they are on call.

1.5 Weekly On-Call Schedule

The on-call schedules for each week are distributed every Tuesday by the Clerical Unit staff to the Watch Commander, Homicide, and laboratory personnel. Any changes in the call-out schedule need to be reported by the previous Monday to the appropriate clerical unit staff. Any changes with less notice need to be distributed to the appropriate personnel.

1.6 Tracking Forms

After a criminalist has attended a crime scene as the primary analyst responsible for writing the report, he or she must fill out a tracking form at his or her earliest convenience, and turn this form in to the crime scene reconstruction program supervisor. The following form is located on the department LAN at G/Laboratory/Crime Scene Reconstruction/Crime Scene Form.



**SAN DIEGO POLICE DEPARTMENT
FORENSIC SCIENCE SECTION
CRIME SCENE NOTIFICATION**



Crime Scene Information

Type: (Scene, Vehicle, Photo Reconstruction)	
Case Number	
Scene Location	
Victim	
Suspect	
Detective (name, ID#, unit, phone #, email)	
Date of Incident	
Today's Date	
Criminalist	

ITEMS ANALYZED AND METHODS USED ARE AT THE DISCRETION OF LABORATORY MANAGEMENT AND/OR ANALYST

Additional Information:

ARCHIVED

1.7 Statistics

Crime scene statistics will be tracked by the crime scene reconstruction program supervisor, and reported to the laboratory manager on a monthly basis.

1.8 Program Administration

The program will be administered by the crime scene reconstruction program supervisor. The following are responsibilities of that supervisor.

- Establish the on call schedule and ensure callout coverage.
- Assess the training needs of the individuals and ensure the necessary training occurs.
- Conduct periodic crime scene reconstruction program meetings.
- Conduct administrative reviews of the reconstruction reports.
- Provide crime scene reconstruction services as needed for cold cases.
- Track crime scene reconstruction statistics on a monthly basis.

ARCHIVED

2.0 TRAINING PROGRAM

2.1 Recommended Training

All criminalists responding to crime scenes should have the following courses:

- Basic Bloodstain Pattern Interpretation
- Crime Scene Investigation I
- Crime Scene Reconstruction
- Firearms Safety

2.2 Additional Training

Additional courses that are available include:

- Forensic Pathology of Wounds
- Firearms Trajectory Reconstruction
- Advanced Bloodstain Pattern Interpretation
- Advanced Crime Scene Reconstruction
- Crime scene Reconstruction II

Note: A sequence of in-house experiments in bloodstain pattern interpretation may be substituted for the Bloodstain Pattern interpretation course. Additional in-house training may serve as a substitute for other courses listed above.

All criminalists training to respond to crime scenes will spend a year on-call, training with criminalists in the rotation. The trainee will be listed on the Weekly On-call Roster as the Reconstruction Trainee. It is the trainee's responsibility to coordinate with the criminalists on-call with respect to availability during any given week. It is not mandatory that the trainee respond to every scene; however, it is expected that the trainee will respond to scenes when he or she is available. At the end of the year, the trainee will be responsible for writing a co-signed report with the trainer in each of the three categories: homicide reconstruction, OIS reconstruction, and a search for biological fluids. These reports will be sent through the review process. Upon successful completion of these reports, along with required competency testing, the trainee will be ready for on-call duties.

Literature review for this forensic discipline is made possible through the reference library located in the crime lab conference room, and through internet resources. It is the responsibility for all personnel in this program to seek relevant literature sources. Criminalists responsible for crime scene reconstruction will be sent to

professional meeting (CAC, AAFS, IABPA, ACSR, etc.) for additional training as laboratory funding allows.

3.0 VEHICLE CARE

The day to day maintenance and care of the crime scene vehicle is the responsibility of the team member on call. When care of the vehicle is turned over to the next team member, the vehicle will be washed and the gas tank full. The front passenger area of the vehicle should be cleaned and vacuumed if necessary.

The vehicle is serviced by the police garage every 4000 miles. It is the responsibility of the person on call to arrange for this service when the vehicle is within 500 miles of this limit. The Criminalist assigned to the vehicle will check the mileage at the end of his or her on-call week.

ARCHIVED

4.0 CRIME SCENE RESPONSIBILITIES

4.1 Call-Outs

On-call personnel will be called out to crime scenes at the discretion of the Homicide Sergeant.

When a team member is contacted, the team member should obtain the location, contact information, and some general information about the type of crime that has occurred and what is needed from the criminalist, such as a search for biological evidence or evaluation of bloodstains. The expected response time is one hour if the Criminalist has taken the on-call vehicle home, and two hours if the Criminalist must return to Headquarters for the on-call vehicle and/or supplies. If unavoidable delays are encountered, an estimated time of arrival should be given to the scene personnel.

4.2 Check-In

Check in with the officer in charge of the scene. Do not enter the scene without the officer's permission.

Obtain a briefing from the appropriate personnel, to include the details of the crime as known.

After evaluating the scene, a team member may determine that an additional expert is necessary to assist in interpretation and documentation. The back-up criminalist should be contacted to provide assistance. If the back-up criminalist is unavailable, or if the additional assistance is needed, the duty supervisor is contacted to assist in making the appropriate calls.

4.3 Team Process

The scene is processed by the Homicide scene detective, the crime scene specialist and the criminalist using a team approach.

The scene detective is in charge of the scene and is responsible for the official crime scene sketch and all of the official measurements. The crime scene specialist is responsible for evidence collection and photography. The role of the criminalist is to assist in reconstruction and/or offer expertise in specialized areas. The actual roles and functions of the team members may vary depending on the circumstances of the scene.

4.4 Specific Responsibilities of the Criminalist

The following are areas of expertise an on-call criminalist is required to have:

- bloodstain pattern interpretation
- trace evidence collection
- reconstruction
- firearms trajectory reconstruction
- presumptive chemical testing
- luminol application
- alternate light source applications.

4.5 General Crime Scene Perspectives: Observations and Assessment

The role of the criminalist at the crime scene is to assist the Homicide team in reconstructing the crime. The criminalist has specific expertise in evidence identification, which can be utilized by any investigative unit to provide information for the detective. In general, evidence can be anything that supports or refutes a possible event or series of events. The full meaning of the evidence is a function of time and the item's relationship to its surroundings. These concepts need to be kept in mind when approaching a crime scene.

The following are types of information the criminalist might need to know.

- Sequence of events evidence. This includes anything that can establish the order of events relative to the crime.
- Directional evidence which gives information regarding the path or motion of an object or individual at the scene.
- Evidence showing position or action of the victim or suspect.
- Items of evidence that establish the origin of an object or the identity of persons involved in the crime. This can include fingerprints, shoeprints, tool marks, physical matches, etc.
- Evidence limiting the scene. This might include presence or absence of blood, obvious signs of a struggle, drag marks, etc.
- Information derived from the experience of the criminalist or any of the investigators. Each individual at the scene has his or her own collection of experiences, which will aid in determining plausible explanations for the reconstruction of the crime.

Reference: J. Ryneason, *Evidence and Crime Scene Reconstruction*, 4th ed. (1995).

4.6 Scene Documentation

Document your arrival time at the scene, the scene address, and the contact person. Note the general points of the briefing and the person who gave the briefing. Note the general location of the scene (e.g. indoor, outdoor, dwelling type, etc.).

After the walk-through, begin your documentation creating notes of all evidence and observations relevant to your reconstruction. Diagrams or sketches should be created to visually place items of evidence within the scene. The scene detective is responsible for the official scene sketch that includes evidence locations and overall room settings. The sketch made by the criminalist is used by the criminalist to refresh recollections of, and add context to, evidence and its location at the crime scene.

The initial scene description should include the overall structure, point of entry, and relevant items or observations. As you progress through the scene note any signs of struggle, tracks, bloodstains, and/or multiple locations of apparent action.

Document the body location in the scene and note the position of the head and limbs. Note the presence/absence of clothing and the position and condition of the clothing. Note and describe any obvious wounds. Make note of any drag marks or stains in other areas that could indicate movement of the body.

Do not move or touch the body until the Medical Examiner (ME) personnel arrive and give permission to do so. Make notes of the ME's examination and preliminary conclusions including wound descriptions. Once the body is removed check the area for other evidence that might have been under the body. Any evidence in the immediate vicinity of the body should be documented prior to the body being moved by the ME, as the evidence may become altered or destroyed in the process of moving the body.

4.7 Abbreviations

The following is a list of abbreviations commonly used in note taking while documenting observations and evidence at crime scenes.

Abbreviation	Definition
S	Suspect
V	Victim
OFC or OFF	Officer
M.E.	Medical Examiner

cc	Cartridge Case
BWC	Body Worn Camera
HVIS	High Velocity Impact Spatter
MVIS	Medium Velocity Impact Spatter
LVIS	Low Velocity Impact Spatter
ALS	Alternate Light Source
Phenol	Phenolphthalein
A.P.	Acid Phosphatase
Det	Detective
CSS	Crime Scene Specialist
RP	Reporting Party
Crime-lite 80S (Blue) handheld Serial#1034	CLB1
Crime-lite 80S (Blue-green) handheld Serial#1011	CLB1
Crime-lite ML (Blue) tabletop Serial#1155	CLB2
Crime-lite ML (Blue-green) tabletop Serial #1045	CLBG2

Abbreviations used in note taking that are not universally common, such as N for north, that are not included in this list must be defined in the crime scene notes.

5.0 BLOODSTAIN PATTERNS

Your notes must include sufficient detail to support a written conclusion. When making interpretations regarding bloodstains and bloodstain patterns to be used as part of the reconstruction or in a written conclusion, the notes should address size and shape of stains(s) and their directionality. Documentation regarding bloodstains present at the scene that are not intended to be used as part of the reconstruction or conclusions will include the location and type of bloodstain (contact, wipe, saturation, etc.). Sketches, charts, photographs, and written descriptions are all acceptable documentation techniques.

When bloodstain terminology is used, the definition of that specific terminology, or the action that caused the pattern, should be included in the report.

When documenting and reporting on blood-like stains, only blood coming from a bloodletting wound on a body, or a collection of blood coming from that wound and directly beneath the location of the wound may be referred to as “blood.” Any blood-like stains not meeting these criteria, including stains at any distance from the body, or stains present in the absence of a body, must be referred to as “apparent blood.”

Photography should include an overall shot of the pattern, close-up shots of the individual stains, and close-up shots of the individual stains with a scale.

5.1 Stringing

When a bloody surface is subjected to an impact, blood will be dispersed from the impact site in several directions. String or imaginary lines projected back in the direction of travel from several bloodstains will converge to a central area. If several different impact sites are present, a corresponding number of different areas of convergence will result.

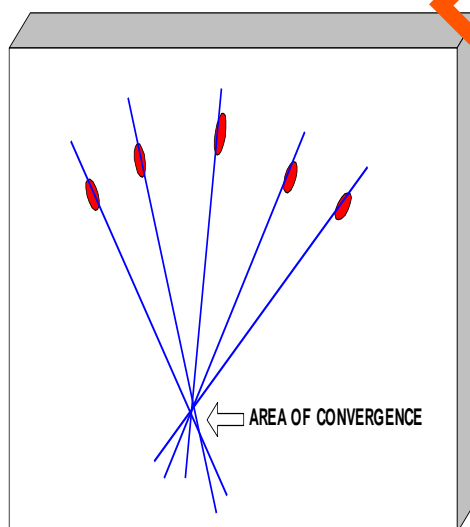

AREA OF

CONVERGENCE

Determine the angle of impact of each stain by measuring the width and length of the stains, then divide the width by the length and take the inverse sine. Alternately, the angle of impact can be read from a plot of the width to length ratio versus known impact angles. See the worksheet and plot at the end of this section.

Once the area of convergence and the angles of impact have been established for a group of stains, a string line can be projected from each stain at its angle of impact back to an anchor point (ring stand) parallel to the surface being examined, in front of the area of convergence. The area in which the strings cross indicates the distance from the surface from which the stains originated. Use string of different colors when several impact areas are present.

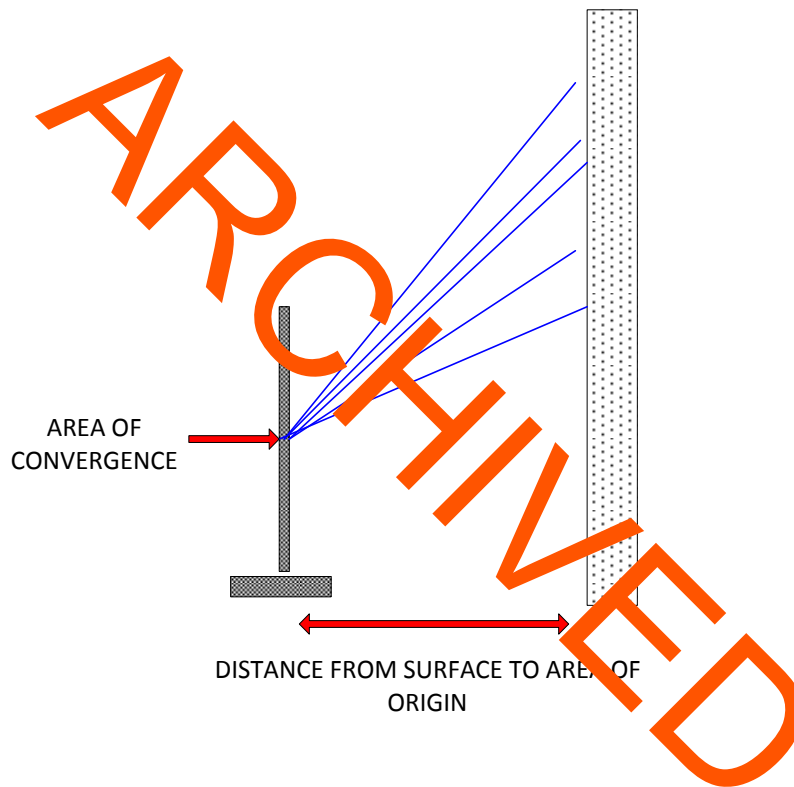

AREA OF ORIGIN

Photographs of the bloodstains with the strings attached showing the area of origin are helpful aids for courtroom presentation. Photo documentation of the area of origin of the bloodstain pattern should include:

- a side view taken perpendicular to the strings
- a top view taken from above the strings.

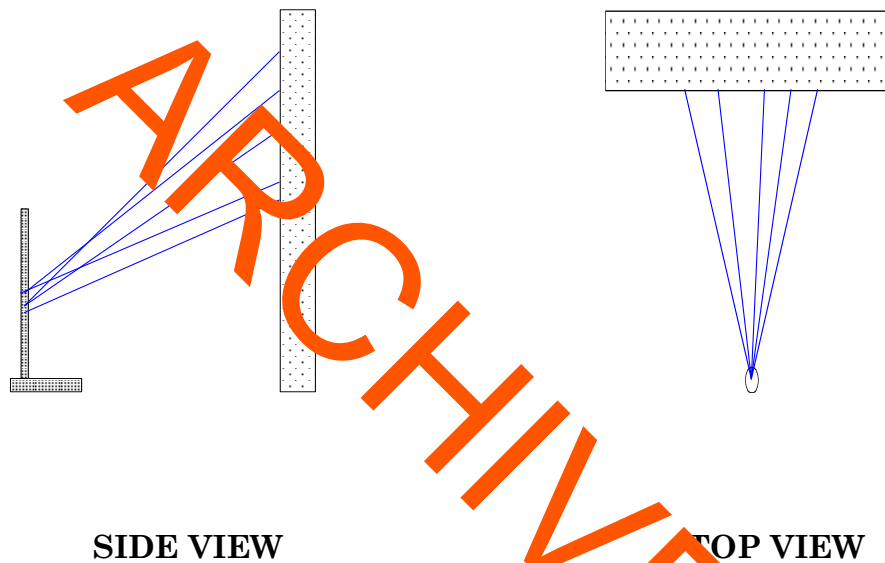

Reference:

Terry L. Laber and Barton P. Epstein, *Experiments and Practical Exercises in Bloodstain Pattern Analysis* (1983).

5.2 Gridding

Gridding can be utilized to document and reconstruct bloodstain patterns. Gridding is particularly useful for photo documentation of an entire pattern. A grid can be easily constructed using colored string and tacks or tape. Using a plumb line, vertical lines are run down a vertical surface. A plumb line is a weight attached to a string hung from the ceiling near or adjacent to the surface to be gridded. The plumb line will establish the true vertical of the wall. The vertical strings are placed equal distance apart appropriate to the stain size being documented. Horizontal lines are run using a level. These lines are placed the same distance from each other as are the vertical lines, creating a square grid pattern. Photograph each square. Include a scale in each picture. The camera must be equidistant from each square and perfectly parallel to the surface being photographed. By placing a small number or letter in the corner of each square, after photo documentation, each picture can be “puzzle-pieced” into its original orientation. If necessary, the grid can continue from the walls onto the floor to provide a total and continuous record of the stains at the scene.

Reference:

J. Rynearson, *Evidence and Crime Scene Reconstruction*, 4th ed. (1995).

6.0 FIREARMS TRAJECTORY RECONSTRUCTION

6.1 General

At a shooting scene, it may be necessary to locate the position of the shooter. Often it is possible to locate the general direction of fire from bullet impact sites on walls or other objects. Three elements are critical in determining the bullet's pre-impact flight path:

1. The location of the bullet or impact site.
2. The vertical angle of the bullet's path.
3. The azimuth (horizontal) angle of the bullet's path.

Examine the scene for all bullet impact marks. Note the nature of these markings (ricochet, impact point, etc.) Note the possible travel paths of the bullets, and where additional bullets may be logically located.

A second hole, mark, or a thick substrate is required to do an accurate trajectory reconstruction. If an anchor point is present, a criminalist may use a laser, string, or a dowel to indicate the path of travel of the bullet.

6.2 Definitions

<i>Angle Finder:</i>	Device that determines the upward or downward angle of the surface it is set on.
<i>Azimuth Angle:</i>	Horizontal angle, left-to-right or right-to-left angle as the bullet penetrates or perforates a surface.
<i>Plumb Line:</i>	Length of string with a weight attached to the bottom.
<i>Powder Stippling:</i>	Small hemorrhagic marks on a surface produced by the impact of gunpowder particles.
<i>Powder Tattooing:</i>	The imbedding of partially consumed and unconsumed powder particles in the skin.
<i>Protractor</i>	Device used to determine the azimuth or vertical angle when measured against a trajectory rod.
<i>Spacer Cones:</i>	Rubber cones that are pushed on to trajectory rods to hold the rods in place in the bullet's path.
<i>Sooting:</i>	Residue of completely burned powder on skin.
<i>Trajectory Rod:</i>	Rod (most commonly metal) that shows the bullet's path.
<i>Vertical Angle:</i>	Vertical angle; ascending or descending angle as the bullet penetrates or perforates one or more objects.

6.3 Locate the Bullet Hole

If a wall, triangulate or take rectangular coordinates to locate the bullet hole on the surface. If a vehicle, take measurement from the ground, and from the front or back plane of the vehicle. Ensure that you can accurately relocate the bullet, whatever the surface. See examples below.

MEASUREMENTS

Triangulation

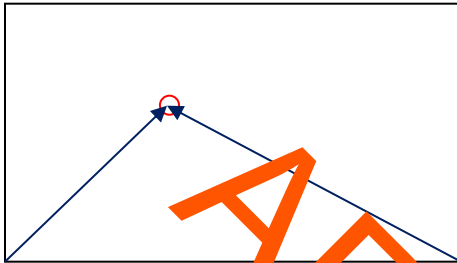

Rectangular Coordinates

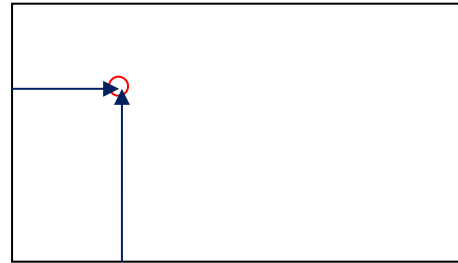

6.4 Determine the Angles

Measure the vertical and azimuth angles using a probe, angle finder, and/or plumb line.

Insert the trajectory rod: Assemble the trajectory rod and connect the tapered spacer cone to either of the ends of the rod. Insert the end of the trajectory rod (that should now be connected to the spacer cone) into the bullet entrance point. The rod should be able to remain in place with minimal movement.



Vertical Angle (Plumb Line Method)

1. Hold the plumb line vertically along the trajectory rod.
2. Hold the zero edge of the protractor vertically against the plumb line.
3. Measure the angle between the plumb line and the trajectory rod.
4. Record your angle.

Vertical Angle (Angle Finder Method)

1. Place the angle finder on the trajectory rod.
2. Record the angle shown on the angle finder.
3. Record your angle.

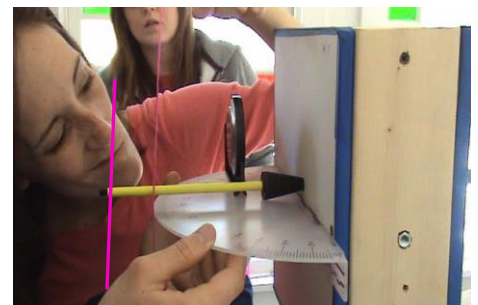

Azimuth Angle (Zero-Edge Protractor Method)

1. Press the protractor up against the surface of the impact. This can be a wall, a windshield, a chair, or any other flat surface that is impacted by the bullet.
2. Be sure to hold the protractor parallel to the floor (making a horizontal plane).
3. Hold the plumb line so that it just touches the trajectory rod and outer edge of the protractor with degree marks.
4. Hold the protractor's central index mark at the center of spacer cone, flush up against the bottom. Look at the trajectory rod/plumb line from overhead.
5. Read the angle that the plumb line is touching on the protractor.
6. Record your angle.

Note: It is important to designate the bullet trajectory, such as left to right, or north to south, to indicate the direction of bullet travel.

6.5 Reporting the Angles

When measuring the angles and notating them, you must provide context for those measurements. The following are common techniques used. Any style the analyst uses is acceptable, as long as it is readily apparent in the notes *which* angle was measured.

Azimuth Angle: This angle can be measured in several ways. By placing a level protractor flush against the surface (ex. a wall) the analyst will note what side of the wall is 0° and what side is 180°.

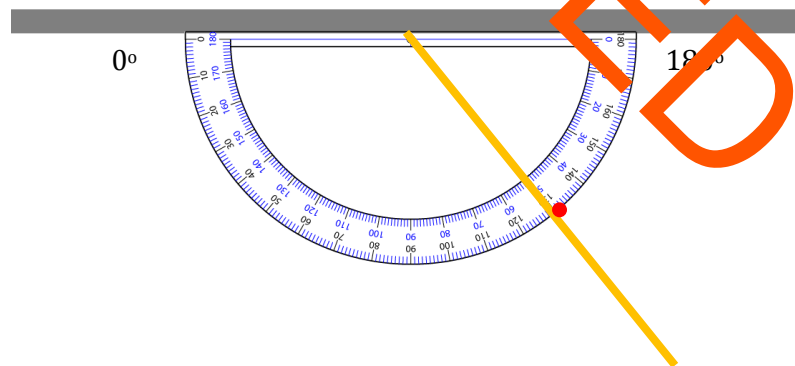

This option will provide an angle of 129°. It is important to note which plane of the vehicle (front or back) or edge of the wall (north, west etc.) the criminalist is using as 0 or 180 degrees. This option does work well in vehicle examinations. Generally the front of the vehicle is designated 0 degrees, and the back of the vehicle 180 degrees.

A second option is to assume that the perpendicular is 90°.

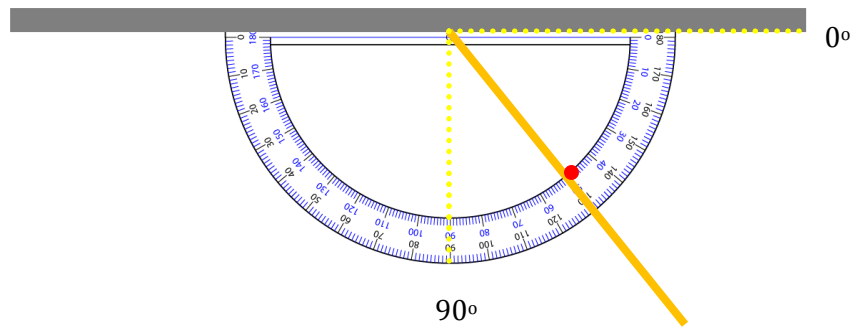

The angle between the surface and the probe can be measured. In this example, the angle is 51 degrees. The bullet can then be reported as traveling right to left at an angle of 51 degrees. If you want to report the angle from the shooter's perspective (NATO method), use the complementary angle ($90 - 51$). Then the angle would be reported as "the shooter fired the gun from 39 degrees right of perpendicular."

Any angle chosen to be measured at the scene will be acceptable, provided that the location of that angle is carefully documented.

Vertical Angle: A bullet path with a downward trajectory is given a (-) sign, and an upward angle of travel is given a (+) sign. Another option is to determine the angles and describe verbally. "The bullet was ascending at a 14° angle."

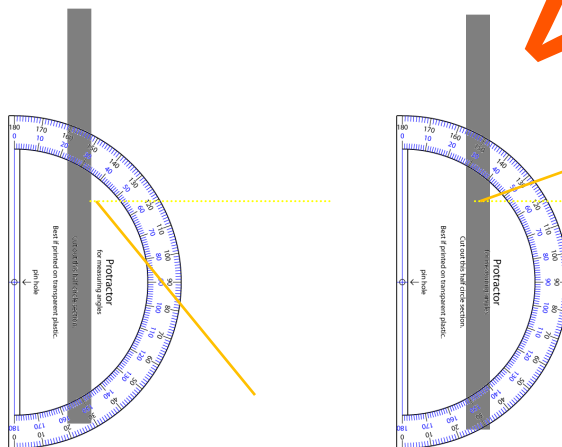

The bullet was ascending at a 50 degree angle. Or, the vertical angle of impact was +50 degrees.

The bullet was descending at a 20 degree angle. Or, the vertical angle of impact was -20 degrees.

6.6 Distance Determination

Gunshot residue patterns are formed on exposed skin surfaces in the same manner as gunpowder patterns are deposited on clothing. Accordingly, the muzzle to target distance can be estimated in the same manner by the direct comparison of gunshot residue pattern standards fired at known distances on test targets to the pattern on the skin. The specific distance determinations are reported by the Firearms Criminalists. However, general information with respect to the characteristics and behavior of gunshot residues with range can be gleaned at the scene to assist in the reconstruction.

6.2.1 Definitions



Sooting and Stippling



Tattooing

6.7 Wounds

Contact Wounds

When a weapon is fired, the bullet, hot gases from burning gun powder, and the metal fragments from the bullet and the gun barrel are propelled from the muzzle. In contact wounds, the hot gases and particulate matter are blasted into the body at the same time as the bullet. The hot gases char the tissues, and the gun powder and metal fragments are deposited along the wound track or on the skin's surface. Contact wounds over bony supported skin can give rise to a stellate or lacerated appearance, due to the expansion and tearing of tissues by gases being blown into the wound.

General Features of Contact Wounds

- Round or oval central defect with an 'abrasion collar' (where the bullet has abraded the skin surface as it passes through it). The size of the defect is comparable to the size of the muzzle opening or bore of the weapon.
- Circular bruise over the skin due to muzzle impact (muzzle imprint).

- Blast injury from muzzle gases (stellate tearing of the skin where there is an underlying bony support, e.g. the skull)
- Gun powder blackening of the wound edges and surrounding skin from soot and unburned particles.

Shots from Increasing Distance

- 1-6 inches: Intense dark sooting with deposits of partially burned and unburned powder particles around the wound entrance.
- 6-12 inches: Some light sooting, with a circular deposit of powder particles around entrance wound. Some powder tattooing and stippling may be present.
- 9-36 inches: No visible soot. A roughly circular widely dispersed pattern of particles may be present around wound.
- 36 inches plus: No pattern from discharge of weapon present. Bullet wipe will be present irrespective of the distance from which the shot was fired.

Accurate estimations of the range of fire of a weapon can only be made following test firing of the suspect weapon, loaded with the same type of ammunition, at different distances, and then comparing the pattern produced by the test fire with that seen on the body. This work will be done, if necessary, by the Firearms Criminalists.

7.0 CRIME SCENE REPORT

A report will be written if a Criminalist is called to the scene, regardless of what capacity you serve or how much work is done. The report is generated from the notes taken at the scene. Any conclusion in your report must be supported by documentation found in your notes or administrative documentation.

7.1 Report Format

The following is a template to be used in crime scene report writing. This report format is for crime scene reconstruction reports as well as for officer involved shooting reports. The goal of the template is to provide consistency throughout the reports, while still allowing enough flexibility for analyst variability. Another goal is to provide user friendly reports, which are tailored to our readers. Extensive notes and measurements are not necessarily appropriate for a report. In addition, organizing a report in a manner which will make sense to the reader is important. Therefore, following a set format will allow your reader to find what he/she is looking for in a lengthy report with less difficulty.

It is expected that any and all pertinent bloodstain information be documented thoroughly in the notes, and will be added as an observation in the report. Any reconstruction that can be done utilizing bloodstain interpretation will be included in the reconstruction of events, both in the observations and in the conclusions of the report. The same is expected of trajectory information gleaned from any relevant crime scene.

Heading:



SAN DIEGO POLICE DEPARTMENT Forensic Science Section

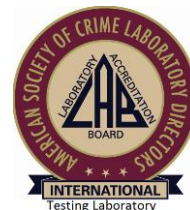

Crime Scene Reconstruction Report

VICTIM:
SUSPECT:
CHARGE:
CASE #:
INCIDENT DATE:
HOMICIDE TEAM:

**CRIME SCENE SPECIALIST:
CRIMINALIST:**

The victim and suspect names are to be entered last name first; the last name is in all caps. It is not necessary to add crime scene specialist interns to your heading.

Body of the report

The body of the report should contain several sections. The first is the BACKGROUND.

BACKGROUND:

The background section should include who contacted you, and what you were requested to do. In addition, when you arrived and to where, along with whom, would be pertinent in this section.

The next section should be your BRIEFING. This can be part of your background section, or a separate section, whichever works best, as long as a briefing is included.

BRIEFING:

This section should contain who gave you the briefing, and all of the pertinent facts. It is NOT necessary to only include information here that you got prior to your scene examination. Information received at a later time information from reports etc., can be added into the briefing section if it seems to flow well. The briefing is important to orient your reader to the scene, and gives context to your report. The briefing should include information relevant to your reconstruction. The briefing does not need to include investigative information.

SCENE DESCRIPTION:

This section should include an overall description of your scene in general terms. In addition, the areas that are pertinent to your reconstruction should be described in detail. It is not necessary to describe rooms or structures in detail if those locations do not figure into your observations. Too much description can detract from your report. For example, a general description of the house, including the overall layout is appropriate; with a detailed description of the room and furniture in any areas where you are making pertinent observations. A sketch in this section is very desirable if it orients your reader to the scene in a fashion that will assist in understanding and visualizing forthcoming observations and conclusions. The sketch be included in the body of the report under this section, rather than be included at the end of the report. This provides the reader with the most useable product. Please reference all sketches or photographs as Figures in your written report, and as a header preceding your sketch / photograph.

The victim description should be part of this section. It can be included as a sub-section of your scene description, or as a separate header. Position of body, state of dress (or undress), and at least a general description of the wounds and their locations should be noted. Much of the wound information can be gleaned at the scene when the medical examiner does his/her initial examination of the body. If no information is available from the scene examination, it may be necessary to get that information from the autopsy report, or through a briefing of the detective or crime scene specialist.

OBSERVATIONS:

A summary of analytical procedures will be included in this section. This list will include the use of any alternate light source used at wavelengths other than white/visible light and any presumptive tests used.

This section will include all of your observations made at the scene, and through review of photographs and other related documents, that are relevant to the reconstruction. It is not necessary to put in measurements for bloodstain pattern/trajectory locations into the body of the report unless it is helpful to the reader to do so. If it is only to provide information to the criminalist (author), then measurements can be confined to the notes. This is a matter of choice, and if you do choose to put measurements into the body of the report, be cognizant of the impact on the report's clarity. It may be necessary to utilize a table format to include copious measurements, as the reader will not have to sort through many paragraphs of numerical information. This section is not meant for conclusions. Therefore, it would be appropriate to discuss where bullet holes were located, where cartridge cases were found, where blood was, and the size, shape, and bloodstain patterns present. This section would also define any bullet trajectories, or determinations related to bloodstain patterns, but it would not be the place for conclusions regarding these observations.

This section can be broken out into General Observations, Firearms Evidence, Bloodstain Evidence, and Trajectories (or some similar type of category) as the need arises. A trajectory section should be separated out from general bullet, casing, and bullet hole observations if the scene is at all complicated. The observations should not be listed in the report in the order they were observed at the scene necessarily, as often the manner in which you process a scene may reflect access to the evidence and not an orderly progression. Present the evidence in the report in a structured, segmented fashion, whether that be by location or type of evidence, whichever is clearer to the reader.

CONCLUSIONS

This section should be brief and to the point. Here the "upshot" of all your work is located for easy reference by the report's reader. It is possible to bullet this section, write in short separate paragraphs, number, or in some way lay out the separate

conclusions that you were able to reach. This section should not include a re-hash of the observations that you have detailed elsewhere in your report. If possible, the conclusions can be as short as “Based upon the observations made at the scene, officer X fired towards general area Y, Z times.” “Based upon the bloodstains in the bedroom on the north wall, the victim was in an upright position during at least some portion of the bloodshed event.” This is obviously extremely simplified, but the general point is to be succinct.

Headings on Additional Pages:

For additional pages, the heading should be the following:

Crime Scene Report
Case Number
Page X of Y

Signature Block

The signature block should include at least the following:

This report contains the conclusions, opinions, and interpretations of the analyst whose signature appears below.

Name, ID Number
Criminalist
Date of Report

Technical Review: _____ Date: _____ Administrative Review: _____ Date: _____

Every case is different, and this template is not meant to be completely restrictive. As long as the basic headings and signature blocks remain the same, the body of the report can be altered to fit your needs in any particular case. Please keep in mind that the report should be clear, and more is not necessarily better. Pictures, sketches, briefings, and clear headings go a long way to creating a report that is understood, appreciated, and useful to the end user.

7.2 Report Timeline

Crime Scene Reconstruction Report: A report including all initial observations and conclusions should be written within three months of the criminalist attending the scene. If a case is particularly complicated, additional lab work or medical

examiner's reports are needed, or there is another extenuating circumstance, the analyst may have up to six months to generate the report after discussion with the Crime Scene Program Supervisor. This report needs to be technically and administratively reviewed prior to distribution.

Officer Involved Shooting Report: A report including all initial observations and conclusions should be written within three weeks of the criminalist attending the scene. If a case is particularly complicated, additional lab work or medical examiner's reports are needed, or there is another extenuating circumstance, the analyst may have additional time to generate the report after discussion with the Crime Scene Program Supervisor. This report needs to be technically and administratively reviewed prior to distribution.

7.3 Reviews

All reconstruction reports must be technically reviewed by a second qualified analyst, and administratively reviewed by the crime scene reconstruction program manager, another supervising criminalist, or the crime lab manager. A list of technical and administrative review elements can be found in the laboratory Quality Assurance Manual.

An analyst should attempt to give his or her report to a variety of analysts for reviews. Utilizing criminalists in other sections with differing experiences for the review process is key to expanding the knowledge of the report writer. It also serves as a mechanism to provide training and refreshers to those that are conducting the reviews.

8.0 USE OF THE CRIME-LITE

Policy

The crime laboratory uses an alternate light source device for the detection of biological stains such as semen, saliva, and urine, which fluoresce at specific wavelengths. The Crime-Lite, is operated at 430nm and 470 nm wavelengths.

Immediately prior to use in the lab or the field, the Crime-Lite will be tested using controls that have been placed with each device.

METHOD: Use of the Crime-lite™ 80S Alternate Light Source Crime Scene Reconstruction Program

MATERIALS:

1. Crime-lite™ 80S (395-500nm & white light)
2. Battery Adaptor with Makita® Rechargeable battery
3. Mains Adaptor
4. Orange goggles or filters

LOCATION:

A Crime-lite™ 80S is located in each of the crime scene response vehicles. A copy of the method and body fluid controls are additionally located with the alternate light source. Information as to the source of the controls are included with the control samples.

The serial number or the Forensic Biology designated unique identifier of the specific Crime-lite™ 80S used must be documented in the case notes. Forensic Biology designations include CLB1, CLBG1, CLB2, and CLBG2. The serial number is located on the plastic ring surrounding the light at its base.



PROCEDURES:

Note: The Crime-lite™ 80S is a portable high intensity light source, which if used inappropriately has the potential to be a hazard to the eyes and skin. Users should use the Crime-lite™ 80S with the awareness that both their own eyes and skin, and those in close proximity, should be protected at all times. Even with protective goggles, exposure time needs to be considered.

1. Connect the output plug holding the Makita® Rechargeable battery with battery adaptor to the Crime-lite™ 80S for portable use.

Connecting the Light Source

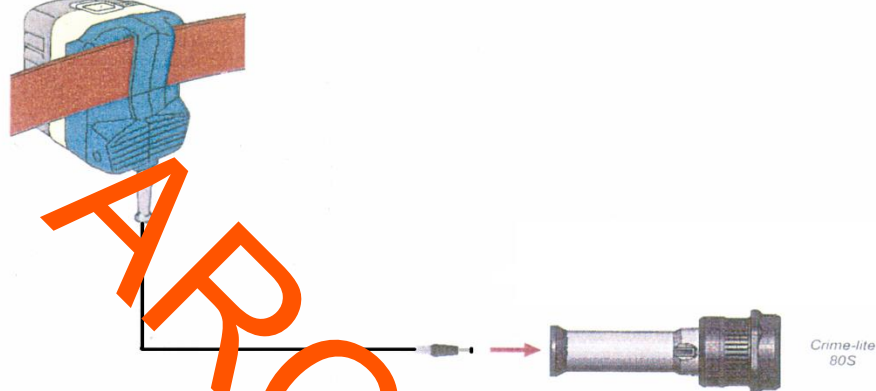

Connecting the Battery Adaptor to the Crime-lite 80L or 80S Forensic Light Source.
Insert the plug from the Battery Adaptor into the socket in the centre of the end cap on the handle of the Crime-lite 80L or 80S Forensic Light Source.
The light source is now ready for use.

If the battery has a low charge or is unavailable, attach the Mains Adaptor to the Crime-lite™ 80S and the nearest outlet.

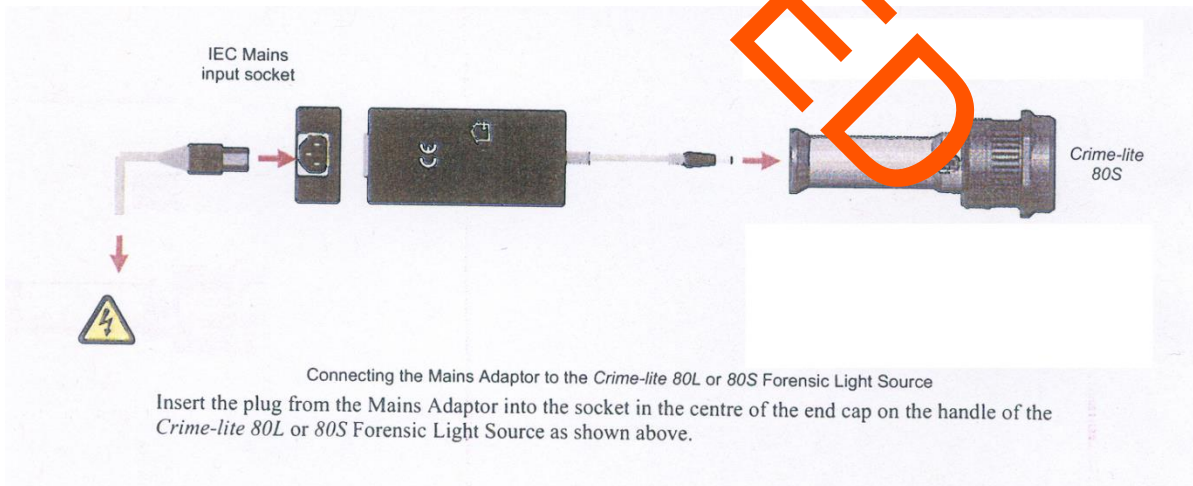

1. Turn on the power switch on the Crime-lite™ 80S.

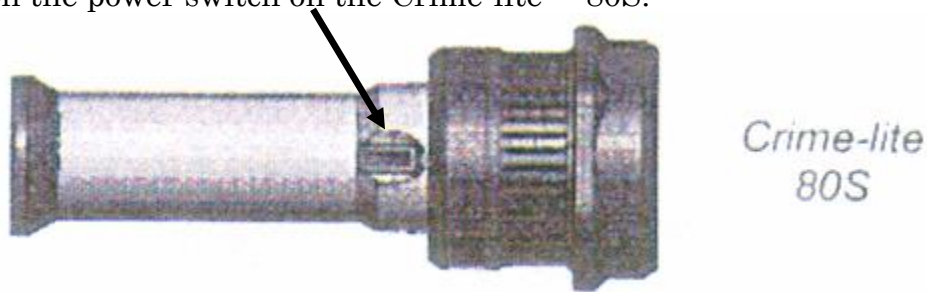

2. Conduct a quality control check of the Crime-lite™ on known biological stains prior to examining evidence and record the results in the case notes.
3. Systematically pass the light over the entire item to be examined. A fluorescent area may indicate the presence of a body fluid stain. Note the area for further testing.
4. Once the examination is complete, turn off the power switch located on the handle. Caution: the light output head will become warm during use.
5. Secure the Crime-lite™ 80S by either placing it on a stable surface or in its carrying case (for long term storage) and by removing the Mains Adaptor or Battery Adaptor.

Charging the Makita® rechargeable battery:

The Makita® Rechargeable battery is a nickel-metal hydride 24V, DC that supplies a Crime-lite™ 80S sufficient power for up to 50 minutes at a fully charged capacity.

Charging

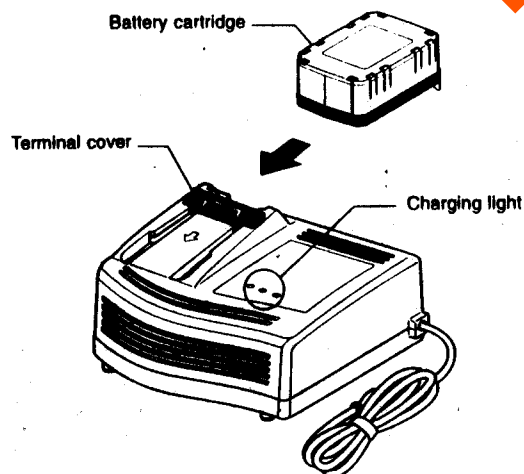

1. Insert the battery cartridge into the charger until it stops adjusting to the guide of the charger. The terminal cover of the charger can be opened with inserting and closed with pulling out the battery cartridge.
2. When the battery cartridge is inserted, the charging light color will change from green to red and charging will begin. The charging light will remain steady during charging.
3. One red charging light indicates charged condition in the range of 0 - 80% and two indicates a range of 80 – 99%.
4. With finish of charge, the charging lights will change from two red lights to two green lights.
5. The charging time is approximately 60 minutes for the Makita® Rechargeable battery.
6. If you leave the battery cartridge in the charger after the charging cycle is complete, the charger will switch into its “trickle charge (maintenance charge)” mode which will last approximately 24 hours.
7. After charging, unplug the charger from the power source.

Tips for maintaining maximum battery life:

1. Charge the battery cartridge before completely discharged. Always stop Crime-lite™ 80S operation and charge the battery cartridge when you notice low tool power.
2. Never recharge a fully charged battery cartridge. Overcharging shortens the battery service life.
3. Charge the battery cartridge at room temperature between 10°C - 40°C. Let a hot battery cartridge cool down before charging it.



REFERENCES:

1. Auvdel MJ. Comparison of Laser and High-Intensity Quartz Arc Tubes in the Detection of Body Secretions. J Forensic Sci. 1988 Jul; 33(4):329-45.
2. Foster and Freeman- Crime-lite™ Information sheet 80S/L: Battery Adaptor. Issue 08 (March 2010)
3. Foster and Freeman- Crime-lite™ Information sheet 80S: Narrowband Light Source. Issue 12 (April 2010)
4. Foster and Freeman- Crime-lite™ Information sheet 80S White. Issue 08 (December 2008)
5. Makita®- High Capacity Battery Charger Model DC24SA Instruction Manual.

9.0 LASER RANGE FINDER

9.1 Calibration Check of the Laser Rangefinder

The Hilti PD42 Laser Range Meter will have the calibration checked on a quarterly basis using the following procedure:

1. A two-point calibration will be done using the 6th floor hallways on the northeast side of the building. The specific alcove area is located just north of the stairwell exit on the 6th floor. The alcove has a window that faces west and is located just outside the Forensic Chemistry Laboratory doorway. The calibration will be done using the alcove walls as guidelines.
2. While standing in the alcove area, face east, and place the side of the rangefinder flush against the south wall of the alcove with the front edge even with the corner (see diagram below). Press the Off Button, located on the top right-hand corner of the rangefinder and then press the Measure Button  just below the Graphic Display. Aim the red laser light across the hallway and check to verify that the laser is visible on the target wall. Ensure that the Horizontal Bubble Level on the bottom, right edge of the rangefinder is centered and press the Measure Button  again. A reading will appear in the Graphic Display. The measurement of this hallway is 43'1^{1/2}". All of the resulting readings must be within the specified accuracy tolerance of 5% (40'11^{5/8}" – 45'3^{3/8}"*) of the established value. Repeat the procedure 2 more times and record all readings in the "Rangefinder Calibration Log" under 'East Facing Wall' column. Multiple measurements can be stored on the rangefinder before clearing the screen. When all measurements have been taken, press the Delete (clear) button  to clear the screen.
3. While standing just outside the alcove area, face south. Line up the back edge of the rangefinder with the wall corner to your west (see diagram below). The range finder will have to be held away from the wall so that the laser can reach the south facing wall unobstructed. Repeat the procedure described above. The measurement of this hallway is 95'5^{7/8}". All of the resulting readings must be within the specified accuracy tolerance of 5% (90'8^{1/2}" – 100'3^{1/8}"*) of the established value. Take 3 measurements total and record all readings in the "Rangefinder Calibration Log" in 'South Facing Wall' column.
4. If all of the measurements fall within the specified accuracy tolerance then the calibration check should be marked as 'Pass' in the "Rangefinder Calibration Log." Should any of the measurement readings fall outside of the specified accuracy tolerance, the calibration check should be marked as 'Fail' in the "Rangefinder Calibration Log." If there is a 'Fail', the rangefinder should not be used until it has been properly adjusted at a Hilti Service Center, and the accurate adjustment of the tool has been confirmed by a calibration certificate.

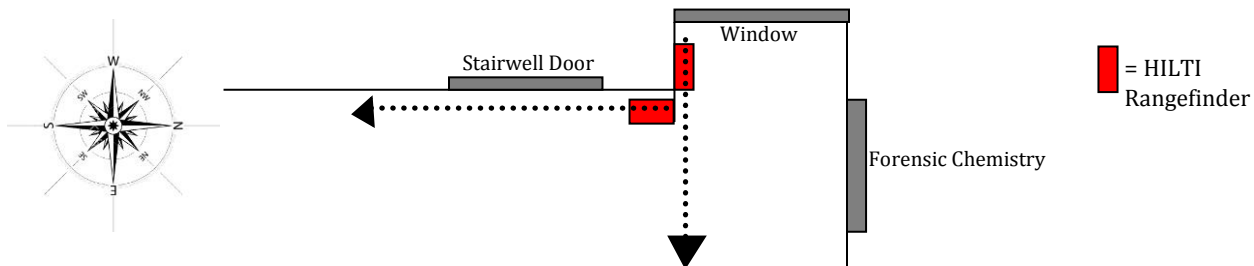

NOTE: By default, all measurements are taken from the back of the rangefinder, as indicated by the icon on the left of the screen . This can be changed—read ‘Method/Directions for Use’ following this page for details.

**The hallways were measured and the above values have been established. Please see Sections 10.1, steps 2 and 3 on the previous page for measurement value information.

9.2 Method/Directions for Use

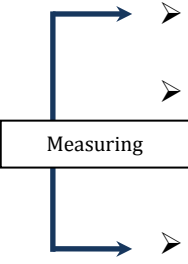
- 
- Press the On/Off Button located on the top right-hand corner of the unit. (1)
 - Once the rangefinder is turned on, press the Measure Button (4). Pressing this button activates the laser, which is emitted from the front of the rangefinder.
 - Aim the laser light at the target surface. **Note: the measuring reference begins from the back of the rangefinder itself, not the front*.** Line up the back and ensure that the Horizontal Bubble Level (6) on the bottom right edge of the rangefinder is centered.
 - Press the Measure Button (4) again to take a reading. The measured distance will appear on the Graphic Display (3). This is the distance between the back of the rangefinder and the target surface.
 - Repeat the measuring steps to take consecutive readings. The last three measurements will continue to appear on the Graphic Display. To clear the screen, press the Delete Button (5) to the right of the Measure Button (4).
 - To take a reading from a corner of any surface where the back of the rangefinder cannot sit flush against a surface, fold out the Measuring Spike (8) from the underside of the unit. The measuring reference is automatically set to the end of the spike when it is folded out. Position the spike against the corner and proceed through the measuring steps to take a measurement reading.
 - When taking measurements in unfavorable light conditions (e.g. in strong sunlight), over long distances, or when taking measurements on curved or inclined surfaces, use the target plate to increase the accuracy of measurements.
 - To power down the unit, press the On/Off Button.

*See Note on bottom of back page.

1. On/off button
2. Side measure button
3. Graphic Display
4. Measure button
5. Delete (clear) button
6. Horizontal bubble
7. FNC-button
8. Folding Spike
9. ¼ " thread for PDA 71 measuring extension
10. Rear contact points
11. Minus button
12. Plus button
13. ¼ " thread on the underside
14. Reference button
15. Optical sight
16. Laser exit lens
17. Receiving lens
18. Vertical bubble

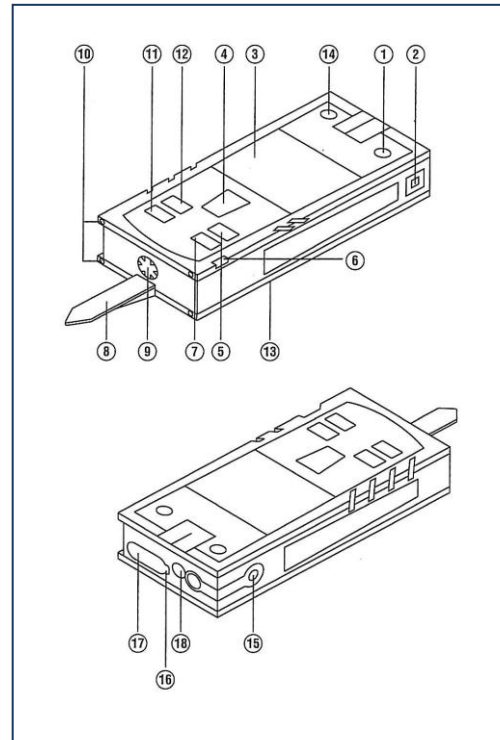

ARCHIVED

10.0 LUMINOL DETECTION OF LATENT BLOODSTAINS

10.1 Purpose

The Luminol test is a presumptive test for the detection of latent bloodstains, not visible to the naked eye. The test is based on the peroxidase-like activity of the hemoglobin molecule. Hemoglobin derivatives greatly enhance the chemiluminescence exhibited by luminol when it is oxidized in an alkaline solution.

Crime Scene Applications: Luminol is well suited to a situation in which there is a suspicion of possible clean-up of bloodstained areas. This test may also be employed to enhance certain bloodstain patterns that may be only partially visible to the naked eye (i.e. drag marks, shoe impressions, etc.).

A Criminalist will be called to the scene to perform the luminol procedure and to interpret any patterns that may develop.

Note: This test is not to be used as a substitute for careful visual examination for blood. The area of interest should be searched in daylight or with the aid of high intensity light prior to the use of luminol.

10.2 Protocol

10.2.1 Reagents and Materials

- Luminol Powder (3-aminophthalhydrazide)
- Sodium Perborate
- Sodium Carbonate
- Distilled Water
- Graduated Plastic Hand Pump Spray Bottle
- 1L labeled plastic bottles
- Ruler with Pennies Affixed to the Ends
- Sponge-tipped Swabs

10.2.2 Controls

- **Positive Control:** A ruler with copper pieces adhered to each end is supplied with the crime scene kit for use as a positive control. The source of the control standard is marked on the package containing the standard and on the ruler. Known blood can also be used a positive

control. The source of the known blood must be documented in the case notes. A strong bluish chemiluminescence (positive reaction) should be exhibited by the standard (copper or known blood) when sprayed with the luminol mixture. The results of this test will be documented in the case notes.

- Negative Control: Area void of any suspected bloodstains. (Area on ruler between copper pieces.)

10.2.3 Preparation

The following proportions of reagents should be employed for 500 mL of luminal spray:

6.0g Luminol Powder
25.0g Sodium Carbonate
3.0g Sodium Perborate
500 mL Distilled Water

If the reagents are not to be used immediately it is best to store the sodium perborate in a separate 50 mL tube. The luminol and the sodium carbonate may be stored together.

1. Label two 50 mL tubes (one for Luminol Powder and Sodium Carbonate and one for Sodium Perborate) with:
 - a. The name of the compounds in each tube
 - b. The lot numbers of each chemical and/or date of preparation
 - c. Initials of preparer
2. Label two 1000 mL containers with:
 - a. Distilled water only
 - b. Name of chemical to be added
3. Weigh out the appropriate amount of the reagents and place them into their respective labeled 50 mL tubes
4. Cover the 50 mL tube containing Luminol and Sodium Carbonate with foil

Note: The chemicals have been pre-measured and placed into labeled 50 mL tubes. These tubes are located on a rack with the luminal kit. Each set of chemicals will make a total of 500 mL of reagent.

10.2.4 Procedure

Add 250 mL of DI water into each labeled plastic bottle. Add the appropriate chemicals to the water in the appropriate labeled plastic bottles and thoroughly mix. (Example: place the chemicals from the *Sodium Perborate* labeled tube into the water in the bottle labeled *Sodium Perborate*.) The water solutions can be stored for some time in this condition. Immediately prior to the luminol application, add equal amounts of the water solutions from the plastic bottles into the graduated plastic spray bottle and mix. Only use the amounts that you will need in the near future, as the remaining water solutions will remain stable if they have not been mixed together.

Note: 500 mL of luminol reagent is enough to process a vehicle or several rooms in a house.

Prior to the application of the luminol spray, place the ruler with the copper pennies affixed to the ends into the general vicinity of the area to be tested. The camera equipment required for documentation of the chemiluminescence should be set up at this point.

Darken the area suspected of containing latent bloodstains to near or total darkness. This includes covering any windows or doors that allow the admission of any light, regardless of how faint. Allow your eyes to adjust.

The nozzle of the plastic hand pump spray bottle should be set to the finest mist setting. Lightly spray the area of interest, as well as the copper pennies on the ruler.

10.3 Interpretation

10.3.1 Positive Control: A strong bluish chemiluminescence (positive reaction) should be exhibited by the standard (copper or known blood) when sprayed with the luminol mixture. The reaction from the standard is used as a positive control for the luminol reagent.11.3.2.

Expected Results: A positive reaction in the area of interest is also identified by the presence of a strong chemiluminescent “glow,” which lasts several seconds. The chemiluminescence exhibited from the oxidation of luminol by a bloodstained area is bluish-white in nature and best visualized under total darkness. (See Figure 1.) Positive reactions with the luminol reagent should

be judged on the color of the reaction, the intensity of the reaction, and the duration of that reaction.

FIGURE 1

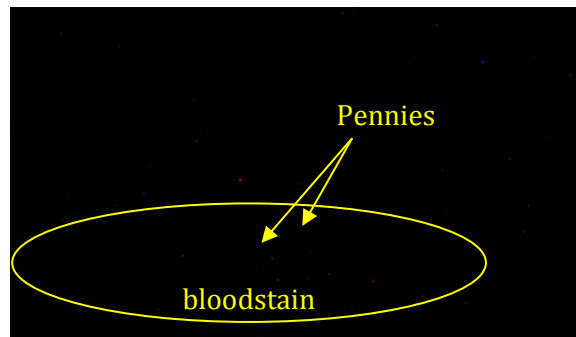
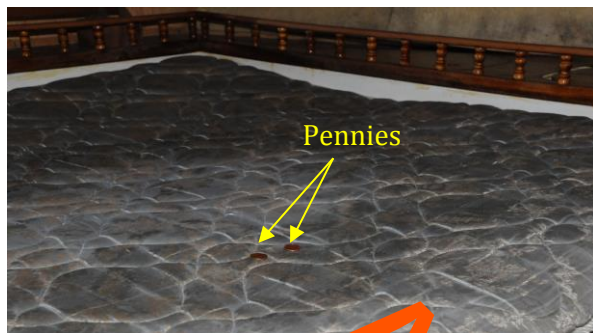

10.3.3 False Positive. It is important to note that luminol will react to produce a false positive with any agent that can oxidize the chemical directly. Some cleaning agents (i.e. Drano and Pine-sol), as well as metallic halides, can produce false positives with the luminol reagent.

Note: A positive reaction obtained with the luminol reagent, even a strong, long-lasting chemiluminescence, is not enough to confirm the presence of blood.

10.4 Collection

General evidence collection guidelines should be used for the collection of luminol- positive areas. If a luminol-positive stain is going to be collected using a swab, use a sponge-tipped swab provided specifically for this purpose. A cotton tipped swab may also be used.

10.5 Documentation

Case notes regarding luminol application should always be taken as with any forensic procedure. Documentation through photography is highly recommended (where possible). Photographic documentation of the luminol reaction is best accomplished in near or total darkness. It is recommended that a control (available light or flash) photograph be taken of the area to be sprayed. A reliable reference scale should be placed in the area to be

photographed. It is important that the camera not be moved between the control photograph and the luminol photograph so that proper orientation and reference can be inferred.

10.6 Safety Considerations

- 10.6.1 May be harmful if inhaled, ingested, or absorbed through the skin. Causes skin and eye irritation. Material is irritating to mucous membranes and upper respiratory tract. Eye protection and gloves must be worn during the application process. A respirator or face mask designed to filter particulate matter is recommended. In case of contact, immediately flush eyes with water for 15 minutes and wash hands with soap and copious amounts of water.
- 10.6.2 Do not dispose of excess luminol at the scene. Bring back to the lab for disposal down the drain.

10.7 References

Della Manna A. and Montpetit S. *A Novel Approach to Obtaining Reliable PCR Results from Luminol Treated Bloodstains*, J. Forensic Sci., 45:886-890, 2000.

RRJ Grispino. *The Effect of Luminol on the Serological Analysis of Dried Human Bloodstains*, Crime Laboratory Digest, Vol. 29(5), pp. 13-23, 1990.

DL Laux. *Effects of Luminol on the Subsequent Analysis of Bloodstains*, J Forensic Sci., 36(5), pp. 1512-1520, 1991.

AM Gross, KA Harris, GL Kadlun. *The Effect of Luminol on Presumptive Tests and DNA Analysis using the Polymerase Chain Reaction*, J Forensic Sci., 44(4), pp. 837-840, 1999.

Sourcebook in Forensic Serology, Immunology and Biochemistry, National Institute of Justice (1980)

11.0 PHENOLPHTHALEIN PRESUMPTIVE TEST FOR BLOOD

11.1 Purpose

The phenolphthalein test is a presumptive test for blood. It is typically used at crime scenes to test stains having a bloodlike appearance when the source of the stain is unknown. A swiftly developing (within 5 seconds) pink to magenta color after step 4 is a positive test and presumptively indicates the possible presence of blood. The results of this test will be documented in the case notes.

11.2 Protocol

11.2.1 Reagents and Materials (Preparation)

1. Phenolphthalein Stock Solution (prepared by the Forensic Biology Unit)
 - a. 10g phenolphthalein powder
 - b. 100g potassium hydroxide
 - c. 100g zinc shavings
 - d. 500mL distilled water
2. Phenolphthalein Working Solution (prepared by the Forensic Biology Unit)
 - a. 4 parts ethanol (200 proof)
 - b. 1 part phenolphthalein stock solution

Add 4 parts of ethanol to one part phenolphthalein stock solution; prepare accordingly since amber glass droppers are ~50mL each. Add zinc metal (10-20%) in the amber bottle(s). The reagent will be cloudy immediately following preparation; let stand refrigerated overnight to clear.

Expiration: Solution is usable as long as it is in the clear (reduced) form. A pinkish solution has oxidized and should be discarded.

3. Hydrogen Peroxide 3% (prepared by the Forensic Biology Unit)
 - a. 1:10 dilution of 30% stock hydrogen peroxide or,
 - b. Commercial 3% solution
4. Cotton applicator swabs or filter paper (test substrates)

11.2.2 Controls

Test reagents against a positive blood standard and against a non-bloodstained area of the substrate before using. Record these results in your notes. The source of the reference standard is marked on the package containing the standard.

11.2.3 Procedure

Moisten a cotton swab or filter paper (the test substrate) with distilled water. Gently press or rub the stain with the substrate. Alternatively, a portion of the stained material can be cut and used directly as the test substrate. Add 1 or 2 drops of phenolphthalein working solution to the test substrate. Observe briefly (up to 30 seconds) for any color change. Add 1 or 2 drops of 3% hydrogen peroxide. Observe for any color change.

11.3 Interpretation

A swiftly developing (within 5 seconds) pink to magenta color after step 4 is a positive test and presumptively indicates the possible presence of blood. When evaluating the color change in this reaction, the appearance of the stain, the amount of material being tested, and the condition of the stain should all be taken into consideration. Analysts may denote a reaction as weak if they can articulate their interpretation (the underlying reason for calling a reaction weak color change that lacks intensity or a delayed color change not to exceed 30 seconds – should be added to the notes).

Lack of a color change before 30 seconds indicates a negative reaction and the absence of blood in detectable quantities.

Bloodstains may change to a greenish color after step 3. Any change to a pink color at this stage may indicate the presence of an oxidizer and should not be interpreted as a positive.

11.4 References

Cox, M. "A Study of the Sensitivity and Specificity of Four Presumptive Tests for Blood", J Forensic Sci. Vol. 36, no. 5 (Sept. 1991), pp. 1503 - 1511

Gaensslen, R.E. Sourcebook in Forensic Serology, Immunology, and Biochemistry, section 6.3

Grodsky et al., "Simplified Preliminary Blood Testing - An Improved Technique and Comparison of Methods", J. Criminal Law, Criminology, and Police Science Vol. 42, (1951), pp. 95-104.

ARCHIVED

12.0 TWO-STEP ACID PHOSPHATASE SCREENING TEST FOR SEMEN

12.1 Purpose

Acid phosphatase is an enzyme found in high concentrations in semen, but is also found in other body fluids and is produced by other organisms such as bacteria, yeast, fungi, and plants. High levels of acid phosphatase can be found in concentrated vaginal discharge or secretions.

The acid phosphatase test is a presumptive test for the presence of semen. It is typically used at sexual assault scenes in an attempt to identify possible semen stains to be collected as evidence. It is most often used in conjunction with the Crime-lite™ in locating and identifying semen stains.

A Criminalist will be called to the scene to search for biological fluids and determine which stains should be collected as evidence.

The specific acid phosphatase test used, either the one step or two step test, will be documented in the case notes summary of analytical procedures listed in the report.

12.2 Protocol

12.2.1 Reagents and Materials

- Sodium Alpha-Naphthyl Phosphate Solution (saturated):
 - Sodium alpha-naphthyl phosphate (a calcium form can also be used) is prepared as a saturated solution in acetate buffer. Prepare fresh or freeze into one use aliquots.
- Ortho-Dianisidine Working Solution:
 - Ortho-Dianisidine (fast blue salt BN) is added to acetate buffer until a yellow brown solution is produced. Prepare fresh or freeze into one-use aliquots.
- Acetate Buffer, pH 5 (Prepared by the Forensic Biology Unit).
 - Add 5mL of glacial acetic acid to 10g of sodium acetate (anhydrous) in a suitable container. Bring volume to 500mL with distilled water. Adjust pH to 5. Good for nine months (refrigerated).
- Spray apparatus
- Disposable pipettes
- Whatman Filter Paper

12.2.2 Preparation

- In one 15mL conical tube, place the sodium alpha-naphthyl phosphate:
 - Using a sterile, plastic disposable pipette, dab the tip of the pipette into the container of alpha-naphthyl approximately three to five times. Dispense the contents of the pipette into the conical tube. Label the tube with:
 - The name of the chemical
 - The lot number of the chemical
 - Initials of the preparer
- In another 15mL conical tube, place the Ortho-Dianisidine (fast blue salt)
 - Using a sterile, plastic disposable pipette, dab the tip of the pipette into the container of Ortho-Dianisidine approximately three to five times. Dispense the contents of the pipette into the conical tube. Wrap the tube in aluminum foil. Label the tube with:
 - The name of the chemical
 - The lot number of the chemical
 - Initials of the preparer
- A bottle of acetate buffer is kept in the Crime Scene Reconstruction refrigerator. The stock solution is kept in the Forensic Biology reagent refrigerator.

12.2.3 Controls

A quality control check of the reagent against a known semen sample and a negative control test of reagents only must be performed before use. The results of the quality control test must be recorded in the case notes. The source of the reference standard is marked on the package containing the standard. Positive tests show a red-purple precipitate. The results of the positive and negative control tests must be documented in the case notes.

12.2.4 Procedures

Note: The chemicals have been pre-measured and placed into labeled conical tubes. These tubes are located in the chemical storage room refrigerator and freezer. The Acetate buffer is stored in this same refrigerator.

- Add 13 mL of acetate buffer to the conical tube labeled “Ortho-Dianisidine (fast blue salt BM)”
- Add 13 mL of acetate buffer to the conical tube labeled “sodium alpha-naphthyl phosphate (α -naphthyl phosphate)”

12.2.4.1 Cutting Method

1. Place a small portion of the sample in a small test tube or on filter paper.
2. Add 1-5 drops of alpha-naphthyl phosphate solution.
3. Add 1-5 drops of ortho-dianisidine solution and observe for any color change.

Positive tests show a red-purple precipitate.

12.2.4.2 Swab Method

- Wet a cotton swab with dH₂O then rub the sample and proceed as above beginning with step 2 on the swab.

12.3 Interpretation

No color change should be observed after adding alpha-naphthyl phosphate. If a color occurs prior to adding ortho-dianisidine, then the results are inconclusive.

The color change observed after adding ortho-dianisidine should occur within 45 seconds to be considered a positive reaction. A strong positive reaction will produce an intense color change within a few seconds. A color change within 10 seconds that lacks intensity will be considered a positive reaction. Any color change that occurs after 10 seconds is considered a weak positive reaction, regardless of color intensity. Any weak reactions should be noted in the case notes. Color change reactions observed after 45 seconds are considered negative.

12.4 References

Blake, Sensabaugh, Bashinski. A Systematic Approach to the analysis of Semen Evidence. CAC Meeting, 6 November 1980

Gaensslen, R.E. Sourcebook in Forensic Serology, Immunology, and Biochemistry, 1983

Saferstein, Baechtel, "The Identification and Individualization of Semen Stains", Forensic Science Handbook, Vol. 2, 1988

Metropolitan Lab. Biology Methods Manual, 1978

13.0 ONE-STEP SERI AP SPOT TEST DETECTION OF ACID PHOSPHATASE

13.1 Purpose

Acid phosphatase is an enzyme found in high concentrations in semen, but is also found in other body fluids and is produced by other organisms such as bacteria, yeast, fungi, and plants. High levels of acid phosphatase can be found in concentrated vaginal discharge or secretions.

The acid phosphatase test is a presumptive test for the presence of semen. It is typically used at sexual assault scenes in an attempt to identify possible semen stains to be collected as evidence. It is most often used in conjunction with the Crime-lite™ in locating and identifying semen stains.

A Criminalist will be called to the scene to search for biological fluids and determine which stains should be collected as evidence.

The specific acid phosphatase test used, either the one step or two step test, will be documented in the case notes summary of analytical procedures listed in the report.

13.2 Protocol

13.2.1 Reagents and Materials

- 0.26g SERI AP Spot Test (SERI Catalog #R558)
- 10mL Distilled/Deionized water
- Whatman Filter Paper and/or cotton swabs
- Disposable Pipettes

13.2.2 Preparation

- Weigh 0.26g of SERI AP Spot Test (check the expiration date) and place inside a small re-sealable plastic baggie. Place the plastic baggie inside a coin envelope. Label both the plastic baggie and envelope with:
 - The name of the chemical
 - The lot number of the chemical
 - Initials of the preparer

13.2.3 Procedure

A quality control check of the reagent against a known semen sample and a negative test of reagents only must be performed before use. The results of the quality control test must be recorded in the case notes. The source of the reference standard is marked on the package containing the standard.

1. Dissolve the AP Spot Test reagent in 10 mL DI water.

Note: The reconstituted reagent will remain stable and sensitive for one day's use at room temperature.

2. Moisten a piece of Whatman filter paper or a cotton swab and vigorously press or rub it against your questioned sample. Alternatively, a small cutting from the questioned sample may be taken and placed onto filter paper.
3. Drip the AP reagent onto the filter paper, swab, or cutting on filter paper.

13.3 Interpretation:

The color change observed after adding ortho-dianisidine should occur within 45 seconds to be considered a positive reaction. A strong positive reaction will produce an intense color change within a few seconds. A color change within 10 seconds that lacks intensity will be considered a positive reaction. Any color change that occurs after 10 seconds is considered a weak positive reaction, regardless of color intensity. Any weak reactions should be noted in the case notes. Color change reactions observed after 45 seconds are considered negative.

13.4 Reference:

Serological Research Institute. Laboratory Protocol, September 29, 1989

14.0 SODIUM RHODIZONATE TEST PROCEDURES AND REAGENT PREPARATION

14.1 Purpose

The sodium rhodizonate test will reveal the presence of lead around bullet holes, impact sites, and secondary lead patterns caused by the impact. As a lead bullet or projectile with exposed lead impacts a surface, lead can be deposited downrange of the impact site giving analysts critical information regarding trajectory and directionality. Through either direct analysis or a transfer, deposits of lead can be revealed and documented using the sodium rhodizonate test.

A saturated sodium rhodizonate solution is sprayed on an item of evidence that is suspected of containing particulate or vaporous lead deposits. The development of a pink color indicates the presence of lead. The item is then sprayed with dilute hydrochloric acid. A change of color from pink to blue-violet confirms the presence of lead.

14.2 Protocol

14.2.1 Materials and Equipment

- Filter paper
- Tartaric acid
- Sodium bitartrate monohydrate
- Sodium rhodizonate
- Dilute (5%) HCl (prepared from concentrated HCl)
- Spray bottle
- Lead nosed bullet standard

14.2 Reagent Preparation

The sodium rhodizonate solution is made fresh each time the analysis is done. Each time a test is performed, the chemicals are checked with a blank and a lead standard. The results will be recorded in the analytical notes.

A saturated solution of sodium rhodizonate is prepared by adding ≈ 0.05 grams of the dry sodium rhodizonate reagent to ≈ 150 mls of distilled water until the solution is the color of strong tea. Sediment of undissolved reagent will remain in the bottom of the container after mixing if the solution is saturated.

The tartrate buffer is prepared by adding 4.75 grams of sodium bitartrate and 3.75

grams of tartaric acid to 250 mls of distilled water. Pour into a spray bottle.

The dilute HCl solution is prepared by adding 12.5 mls of concentrated HCl to 237.5 mls of distilled water.

Note: The 5% HCL and tartrate buffer solutions have been pre-measured and placed into labeled spray bottles. The sodium rhodizonate has been pre-weighed and placed into small manila envelopes ready to add to a labeled water filled spray bottle. These reagents are located on a rack with the luminol kit.

14.3 Standards and Controls

In order to verify the reactivity of the reagents, a standard will be used in conjunction with a blank in the test procedure. The standard will be a simple wipe mark on filter paper with a lead bullet from the ammunition reference collection in the firearms laboratory. The standard is located with the reagents. The blank will be a clean piece of filter paper. A comparison sample of the surrounding area known or believed not to contain lead can also be tested. The source of the reference standard is marked on the package containing the standard.

14.4 Procedures

14.4.1 Sample Collection (for testing at the laboratory)

1. Document the area of interest to be tested by photography or sketching. Mark the filter paper as to the location and orientation of the strike mark or hole.
2. Dampen a piece of filter paper with a dilute solution of tartrate buffer. Press the filter paper firmly against the test area, without allowing the paper to slide across the surface of the item/area being tested. Maintain contact for at least 30 seconds to allow for a complete transfer.
3. The collection of a comparison sample can be done by using a new piece of filter paper with tartrate buffer. Locate an area adjacent to the strike mark or hole in question, and sample the area as described above. Label the sample appropriately.
4. At this point, the filter paper can be allowed to dry. Record pertinent case information on the filter paper and package it for transport back to the lab where the lead testing can be completed.

14.4.2 Lead testing

1. For each sample area being tested, a blank and a positive control must be tested and documented alongside the evidentiary samples.
2. Spray the filter paper with the tartrate buffer solution.
3. Spray the samples with the aqueous sodium rhodizonate solution until saturated. A positive reaction for lead will be the development of a pink color. Alternately, the solution can be applied drop wise onto the filter paper.
4. Spray the filter paper with dilute HCl. The presence of lead is confirmed when the pink color transitions into a blue-violet color.
5. Record the results in the notes. Photography of the filter paper with the reaction is suggested. The photography should be done promptly as the positive results can fade unpredictably.

14.4.3 Sample collection and lead testing (for field testing)

1. Document the areas of interest to be tested by photography or sketching. Mark the filter paper as to the location and orientation of the strike. Mark or hole.
2. Dampen a piece of filter paper with tartrate buffer solution. Press the filter paper firmly against the test area or inside the defect, without allowing the paper to slide across the surface of the item/area being tested. Maintain contact for at least 30 seconds to allow for a complete transfer.
3. The collection of a comparison sample can be done by using a new piece of filter paper with tartrate buffer solution. Locate an area adjacent to the strike mark or hole in question, and sample the area as described above. Label the sample appropriately.
4. Spray the filter paper samples with the aqueous sodium rhodizonate solution. A positive reaction for lead will be the development of a pink color.
5. Spray the filter paper samples with the 5% HCl solution. The presence of lead is confirmed when the pink color transitions into a blue-violet color.
6. Record the results in the notes. Photography of the filter paper with the reaction is suggested. The photography should be done promptly as the positive results can fade unpredictably.

14.5 References

Gunpowder and Primer Residues, "The Sodium Rhodizonate Test," Dillon, John H., Jr. FSRTC, FBI Academy, Quantico, Virginia.
Haag, Lucien C. Shooting Incident Reconstruction. Massachusetts: Elsevier Inc., 2006.

15.0 CCW POLICY

15.1 Individuals Approved to Apply for a Concealed Carry Permit (CCW)

Only those deemed “qualified personnel” will be approved to apply for a concealed carry permit through the Department. This will include all current crime scene personnel to encompass Crime Scene Specialists, Crime Scene Reconstruction Team members and trainees, as well as Criminalists who respond to crime scenes as part of their regular duties.

15.2 CCW Restrictions

The CCW's will be issued by the San Diego Sheriff's Office. The Department will support the CCW with the following restrictions: Valid only in the course of duties as a (insert title here) with the San Diego Police Department. The CCW will only be valid while the employee is on duty.

On-duty is defined as any field work done outside of a police facility. This includes traveling to and from crime scenes. In addition, the employee who is actively on-call and may need to respond to a crime scene from his or her current location is considered on-duty.

15.3 Training

A qualified employee shall complete in-service firearms training, and fulfill all other requirements as set forth for firearms qualifications, as outlined in Department Procedure 1.05.

15.4 Expectations

All Department policies and procedures regarding firearm safety must be adhered to.

A qualified employee authorized by the Chief of Police to carry a firearm during the course of his or her duties shall be required to carry the firearm while on-duty. See 16.2 for the interpretation of on-duty for purposes of this policy.

“Carrying” means that the firearm is physically on the employee’s person, either in a holster or in an attached bag (fanny pack). Carrying does not include keeping the firearm in a crime scene kit, or locked up in a vehicle.

A qualified employee will be required to sign an acknowledgement and agreement of the above policy, as well as DP 1.05. This acknowledgement will be kept in the employee’s divisional file.

Any employee who feels an unrestricted CCW is appropriate in his or her case may petition the Laboratory Manager in writing to have the restrictions lifted.

ARCHIVED