



Southeastern San Diego
Commercial Corridor
Urban Design Guide

Redevelopment Design Concepts & Guidelines



Southeastern Economic Development Corporation

Southeastern San Diego Commercial Corridor Urban Design Guide

Redevelopment Design Concepts & Guidelines

- Town Center at Euclid Avenue and Market Street
- Euclid Avenue Commercial Corridor
- Euclid Avenue and Imperial Avenue Commercial Center
- Market Street Industrial Corridor
- Encanto Village at Imperial Avenue
- Mount Hope Commercial Corridor

Prepared for:



SEDC

Southeastern Economic Development Corporation

Prepared by:

Roesling Nakamura Architects, Inc.

Acknowledgments

The Southeastern San Diego Commercial Corridor Urban Design Guide was prepared by Roesling Nakamura Architects, Inc. (RNP), located in San Diego.

These services were provided for the Southeastern Economic Development Corporation (SEDC) as part of the Commercial Rehabilitation program for Southeastern San Diego.

Principal-in-Charge: Ralph J. Roesling, FAIA

Project Team: Rick Espana, Jennifer Custodio,
 Jamie Ho, Joe Mansfield, Ricardo
 Balvaneda

SEDC and the project team would like to extend their special thanks to the following organizations for their cooperation and valuable input in producing this document:

4th District Council Office of George Stevens, Diamond Business Improvement District, Central Imperial Project Area Committee, Sutter Assets, Jacobs Foundation, Fehlman LaBarre Architects, Frisco White Architects, City of San Diego Planning and Development Review, Metropolitan Transit Development Board, and SDG&E.

Table of Contents

1	Introduction and Goals	
1.0	Project Purpose	1-1
1.1	Planning Study Areas	1-2
1.2	Design Guide Goals and Objectives	1-3
1.3	About the Guide	1-4
1.4	Making it Work.....	1-5
2	Redevelopment Concepts and Guidelines	
2.0	Introduction	2-1
2.1	Principal Commercial Concepts for the Euclid Avenue Commercial Corridor and Adjacent Areas	2-1
2.2	Town Center at Euclid Avenue and Market Street	2-5
2.3	Euclid Avenue Commercial Corridor	2-9
2.4	Commercial Center at Euclid Avenue and Imperial Avenue	2-13
2.5	Market Street Commercial Industrial Corridor	2-17
2.6	Encanto Village at Imperial Avenue	2-23
2.7	Mount Hope Commercial Corridor.....	2-29
3	Design Criteria and Guidelines	
3.0	Purpose and Intent	3-1
3.1	Applicable Areas	3-1
3.2	Land Use	3-3
3.3	Architectural Character	3-7
3.4	Landscaping	3-10
3.5	Circulation and Parking	3-17
3.6	Property Maintenance	3-20
3.7	Commercial Signage	3-24
3.8	Site Furnishings	3-28
3.9	Lighting and Utilities	3-33

4 Resource Guide

4.0 Introduction 4-1

4.1 Southeastern Economic Development Corporation 4-1

4.2 4th District Council Office of George Stevens 4-2

4.3 Diamond Business Improvement District 4-3

4.4 Central Imperial Project Area Committee 4-3

4.5 City of San Diego Planning Development Review 4-4

4.6 City of San Diego Neighborhood Code Compliance 4-4

4.7 City of San Diego Storefront Improvement Program 4-5

4.8 San Diego Police Department Community Relations 4-5

4.9 Market Creek Plaza / Jacobs Foundation 4-6

4.10 San Diego Gas and Electric 4-6

4.11 Metropolitan Transit Development Board 4-6

4.12 Sources of Assistance 4-7

Section 1 Introduction and Goals

The project goal is to enhance the character of the area's retail and commercial services to achieve the community's vision for vital commercial districts.

1.0 Introduction

The Southeastern Economic Development Corporation's *Commercial Corridor Urban Design Guide* is a document for redeveloping specific commercial corridors and nodes within the Central Imperial and Mount Hope Redevelopment Project Areas of Southeastern San Diego.

These commercial corridors and nodes were identified early by the Southeastern Economic Development Corporation (SEDC) and Roesling Nakamura Architects, Inc. (RNP) as strategic "seed" areas that, when guidelines were properly applied, would spark commercial redevelopment throughout the commercial and industrial zones.

As part of the commercial redevelopment project, the *Commercial Corridor Urban Design Guide* provides property and business owners a planning and design framework, in the form of design concepts and regulatory guidelines, to ensure that future development and improvements will conform to high standards of design excellence. In addition, the Guide is designed to:

- Assist in enhancing the community's unique identity.
- Help the community understand its environmental assets and design opportunities.
- Visually enhance existing retail and commercial zones specified in the study area.
- Enhance and preserve the community's historic and cultural heritage.

Urban design guidelines are not distinct from planning - they are a further step that adds refinement, focus, detail and direction to community plans that are already established.

The *Commercial Corridor Urban Design Guide* supports redevelopment concepts that were developed through a series of community workshops held by SEDC and co-sponsored by local community and business groups such as the Diamond Business Improvement District (BID), and Central Imperial Project Area Committee (PAC). In addition to the community workshops, the guidelines consider and incorporate data from past studies, reports and City of San Diego planning documents.



Vicinity Map

1.1 Planning Study Areas

There are six commercial study areas that the design concepts and guidelines address. Three are commercial corridors and three are commercial nodes or centers that have been identified by SEDC for commercial redevelopment. (See Figure 1.1)

These study areas are:

Commercial corridors

- Euclid Avenue commercial corridor from Martin Luther King, Jr. Freeway 94 to Imperial Avenue.
- Market Street commercial industrial corridor between 47th and 54th Streets.
- Mount Hope commercial corridor along Market Street from Interstate 805 west to 41st Street.

Planning Study Areas

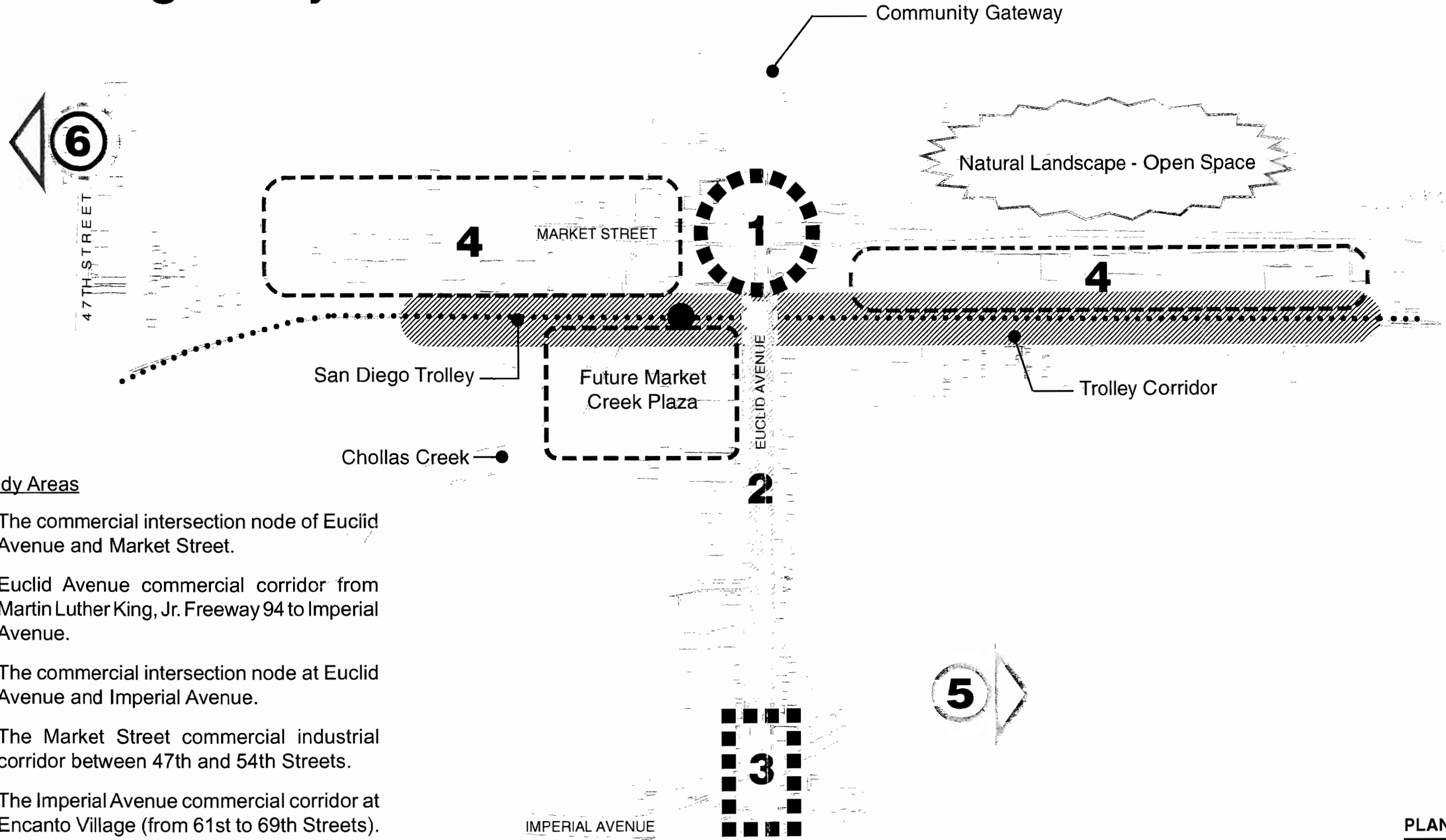

Study Areas

1. The commercial intersection node of Euclid Avenue and Market Street.
2. Euclid Avenue commercial corridor from Martin Luther King, Jr. Freeway 94 to Imperial Avenue.
3. The commercial intersection node at Euclid Avenue and Imperial Avenue.
4. The Market Street commercial industrial corridor between 47th and 54th Streets.
5. The Imperial Avenue commercial corridor at Encanto Village (from 61st to 69th Streets).
6. Mount Hope commercial corridor along Market Street from Interstate 805 west to 41st Street.

PLANNING STUDY AREA

NOT TO SCALE

1.1

FIGURE

DIAMOND DISTRICT

Commercial nodes

- The commercial intersection node of Euclid Avenue and Market Street.
- The commercial intersection node at Euclid Avenue and Imperial Avenue.
- The Imperial Avenue commercial node at Encanto Village (from 61st to 69th Streets).

The guidelines are intended to be applied to existing commercial businesses, future commercial development and public right-of-way infrastructure and are specifically tailored for the individual commercial redevelopment mission of the community and physical settings of Southeastern San Diego.

1.2 Design Guide Goals & Objectives

Goals and objectives have been developed from analysis of past reports and studies, plus a review of existing conditions and meetings with community members. The goals are summarized as follows:

1. Enhance community pride
 - A. Establish a community center that promotes a unique, yet integral and positive identity for the Diamond Business Improvement District as part of the City of San Diego (See Map on Page 1-7).
2. Encourage economic development
 - A. Develop economic attractions that bring the greater community, as well as tourists, into the area.
 - B. Provide a wide range of community services.
 - C. Produce redevelopment concepts that encourage daytime and nighttime pedestrian activity.
 - D. Develop commercial themes that improve economic development for each of the six project areas.
3. Increase mass-transit usage to the areas
 - A. Produce redevelopment concepts near trolley stations.

- B. Provide clear signage that directs visitors to areas of interest.
 - C. Allow trolley stations to serve as activity generators where people can interact and socialize.
 - D. Promote area uses and pedestrian access that encourage trolley ridership for employees of local businesses.
4. Preserve the existing community fabric
- A. Incorporate existing community strengths and opportunities to define concepts.
5. Effectively communicate, motivate and educate the community about design goals and guidelines
- A. Develop a poster that reaches out and effectively communicates the visions, design guidelines and resources to the local business community.

1.3 About the Guide

The Guide is divided into four sections. *Introduction & Goals*, Section 1, provides a brief background of the study, the purpose of the project, and outlines the study areas within Southeastern San Diego.

Goals and objectives are clearly outlined, having been established through the collaboration of local organizations and the community.

Redevelopment Concepts & Guidelines, Section 2, delineates specific design concepts for each commercial corridor and node as well as an overall community center design direction. The concepts and guidelines are conveyed through the use of graphics and text to assist the community in understanding the design approach and direction for the designated redevelopment nodes and corridors.

The *Design Criteria* provided in Section 3 are more specific in nature. Design guidelines are to be applied to the overall commercial redevelopment district and provide a framework that ensures future development and improvements will conform to high standards of commercial environmental design excellence.

And finally, the *Resource Guide* is provided to assist property owners and business owners with contacts for further redevelopment assistance.

1.4 Making it Work

To assist in the implementation of the guidelines, the handbook includes a poster that summarizes the concepts and corresponding guidelines. It will serve to educate the community about its own assets and strengths which help define the community's unique identity.

In addition, the poster outlines each team member's role in reaching redevelopment goals. Members include SEDC, the local business community represented by the Diamond BID, the Central Imperial PAC, the City of San Diego, local agencies, community planning groups, and residents of Southeastern San Diego.

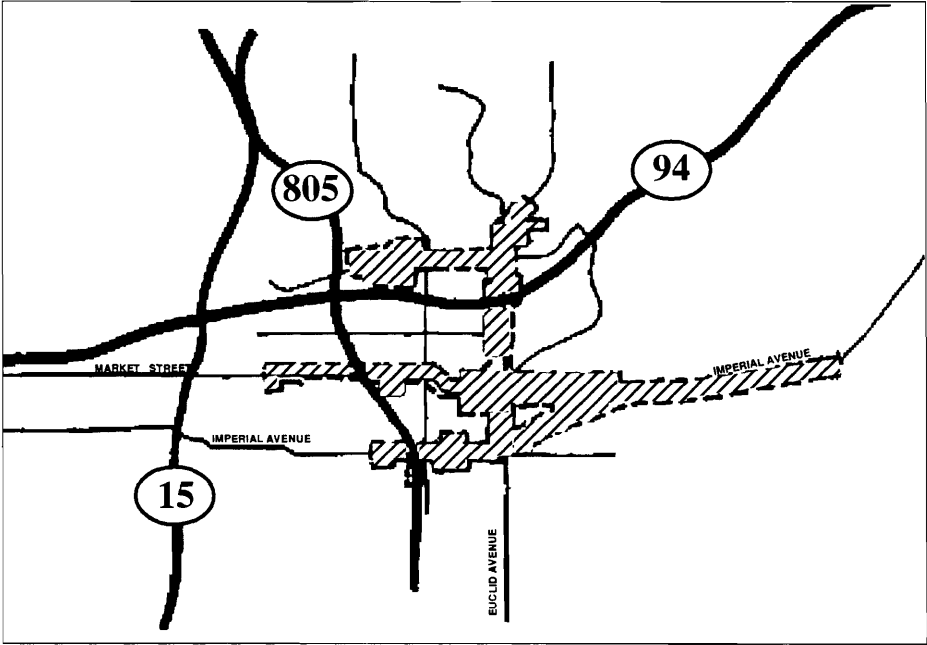

Diamond Business Improvement District



Section 2 **Redevelopment Concepts and Guidelines**

2.0 Introduction

The commercial redevelopment concepts and guidelines were developed through a series of design workshops sponsored by SEDC, the Diamond BID and the Central Imperial PAC. In addition to the workshops, the concepts presented here incorporate data from previous studies, reports, and City of San Diego planning documents that apply to the project area (see Appendix for a complete list).

The concepts and guidelines presented in this section produce a framework of ideas, visions and goals for the individual commercial nodes and corridors. Both area design concepts and guidelines are outlined in this section. General design guidelines are found in Section 3, *Design Criteria and Guidelines*.

The concepts and guidelines are expressed in both written and graphic formats. Both should be used as a guide in the redevelopment of the commercial property within the corridors and nodes.

Diagrams throughout this section graphically describe concepts for each of the corresponding areas. Figures 2.1 through 2.6 illustrate in more detail each of the area nodes and corridors with graphic examples of the design objectives and guidelines.

2.1 Principal Commercial Concepts for the Euclid Avenue Commercial Corridor and Adjacent Areas

The area known as the Euclid Commercial Corridor, from the Martin Luther King Jr. Freeway Route 94 to Imperial Avenue, serves as the main north-south commercial corridor within this region. The corridor links several major land-uses within the area such as commercial, office, residential and industrial.

Because of the corridor's commercial importance, project concepts focus on four subareas: the intersection at Market Street and Euclid Avenue, the intersection of Imperial Avenue and Euclid Avenue, the Euclid Corridor from the Martin Luther King Jr. Freeway Route 94 to Imperial Avenue, and the Market Street Commercial Industrial Corridor between 47th Street and 54th Street.

The individual areas of the Euclid Corridor are explained in further detail under Sections 2.2 through 2.4. Concepts and Guidelines for the Encanto Village at Imperial Avenue and Mount Hope Commercial Corridor are addressed in Sections 2.6 and 2.7 respectively.

Principal design concepts for the Euclid Avenue commercial corridor region address the area's rural history, Chollas Creek, and the development of public plazas.

Rural History

There are several elements within the area to remind us about the region's rural history. These elements include the open natural land tracts, Chollas Creek, topography north of the project sites, and the open space north of Market Street and west of Euclid Avenue.

These agrarian elements still have a large presence within the urban grid. The rural history of the region should not be forgotten. Where possible, new development should respect, retain, enhance and use these features as design inspiration.

Chollas Creek

As an element of the region's rural history, Chollas Creek is part of a system of natural drainage channels that traverses Southeastern San Diego. Although the system has been modified over the years by urban development, the section that crosses Euclid Avenue represents an important design opportunity for the immediate area.

The Proposed Chollas Creek Enhancement Program outlines the concept of creating a regional linear park that blends the natural and built environments. The creek as well as its open space is acknowledged as a positive and unique design feature that adds to the community's overall identity. New development and redevelopment activities should participate in the restoration of the creek where possible, as well as incorporating the creek's streambed as a design opportunity.

Where Euclid Avenue crosses Chollas Creek, an implied "Commercial Gateway" should be established. A gateway at this location would assist in creating awareness of the creek as well as enhance the local community as a rural enclave within the City of San Diego. The gateway should be subtle so as not to direct

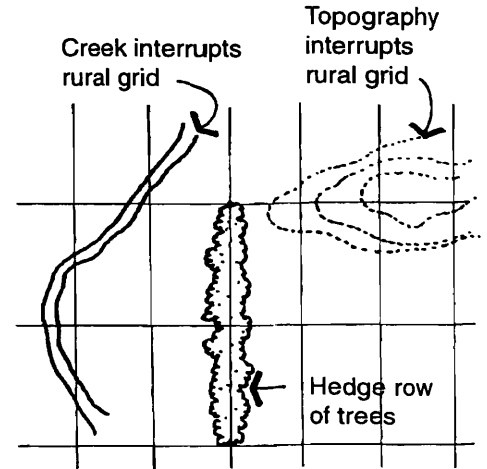

RURAL HISTORY

- Agrarian expression over rural grid (hedges of trees)
- Rustic structures

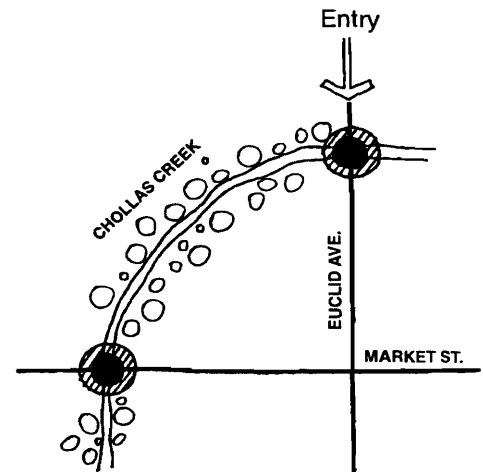

CREEK

- Emphasize creek as natural boundary feature

attention away from the creek, but should be visible enough to announce an entry point into the commercial district and the town center. (See sketch).

A similar gateway element could be established where Market Street crosses Chollas Creek west of Euclid.

Plazas as the Town Center Identity Element

Plazas serve in defining open space, establishing spaces as part of a sidewalk experience, and act as a community resource, allowing a community or groups to share a common space for interaction. The future *Market Creek Plaza*, to be located near the southwest intersection of Market Street and Euclid Avenue, utilizes the Plaza concept to define open spaces as well as the cultural themes present in the community.

The Plaza theme should continue beyond *Market Creek Plaza* and be developed to establish a central community public plaza that defines the region's "Town Center". This plaza should be incorporated within the Euclid Avenue Trolley transit stop to create a public space that serves as the central link to all areas of interest within the community. In addition, the space should contain wayfinding and community informational elements to support and enhance the community's cultural identity. (See sketch and Figure 2.1).

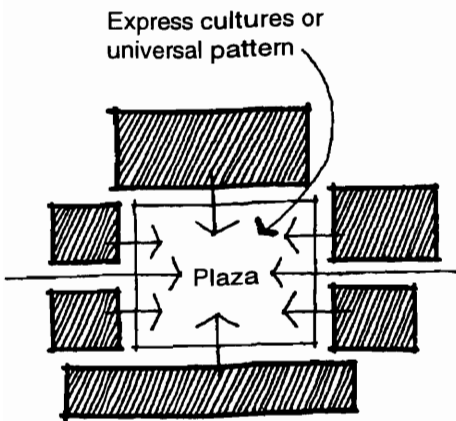

PLAZA AS IDENTITY ELEMENT

- Plaza as space definition and community resource
- Plaza as part of sidewalk experience

INTENTIONAL BLANK PAGE

2.2 Town Center at Euclid Avenue and Market Street

2.2.1 Concept

At the Euclid trolley station, a **Community Town Center** should be established. The center should **serve** as the **central node** that establishes wayfinding links to all **major points of commercial and cultural interest** in the immediate area.

To build upon the area's unique **assets such as the Tubman Chavez Community Center, the Malcolm X Library, the Elementary Institute of Science and the future Market Creek Plaza**, the design of the center should express a **"multi-cultural educational"** theme. A central **"plaza"** should orient and educate visitors about the area's unique assets, the community, its history and local attractions.

A **"nexus"** which represents a **connection or union of wayfinding and urban design elements** would link the cultural centers and local area attractions. (See Figure 2.1).

2.2.2 Concept Objectives

- Emphasize the **Euclid Avenue/Market Street node** as an important transit node and **gateway into the community**.
- Reinforce the node as the **Community Town Center**.
- Unify the appearance of the **intersection corners** with landscaping and enhanced **paving**.
- Create a **seamless connection of landscaping** between properties.
- Retain and enhance **natural features**.
- Promote pedestrian safety through the use of enhanced paving.
- Enhance streetscape image through the use of landscaped medians, enhanced paving at the intersection, and landscaping.
- Add wayfinding elements that **educate and direct pedestrians** to area points of interest.

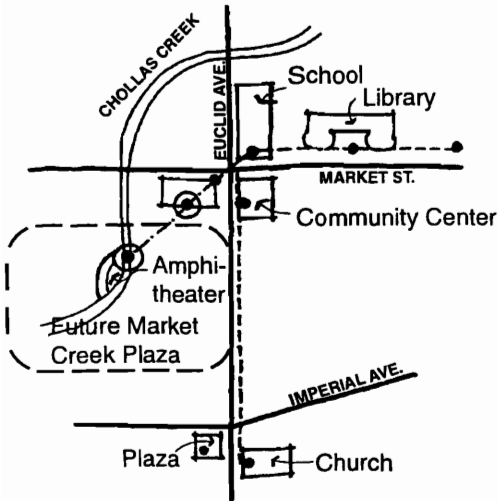

CULTURAL NEXUS

Cultural Centers connected by urban design elements and wayfinding elements

2.2.3 Concept Guidelines

Open Space and Landscaping

A community plaza near the trolley station will establish the “heart” of the community. The plaza shall consist of enhanced paved surfacing, information/wayfinding signage, shade structures, seating areas, and landscaping.

Directional signage shall be provided at key wayfinding points from the trolley station to points of interest. Signage shall incorporate the design theme and materials expressed in Figure 2.1.

The intersection shall be landscaped to create a unified appearance. Pedestrian crossing zones shall consist of enhanced paved materials and shall incorporate patterns that are consistent with the overall design theme found in the immediate area. Landscaping shall be approved by SEDC and reviewed by local community planning groups and the respective Project Area Committee.

Landscape medians along the Euclid corridor shall be incorporated into the site to deter illegal pedestrian street crossing, provide a unified landscape theme, and promote safety from street automobile traffic.

Landscape medians will consist of low wall planters made of poured-in-place concrete with a sandblasted finish. Refer to Figure 2.3 Street Section B.

Public art shall be incorporated into the public plaza to express the location as the “Cultural Center” of the community. The art shall be approved by SEDC and local community planning groups.

TRANSIT STOP

- Emphasize special place
- Linear wayfinding elements intersects node
- Wayfinding elements greet passengers at stop
- Sense of arrival
- Plaza acts as orientation compass

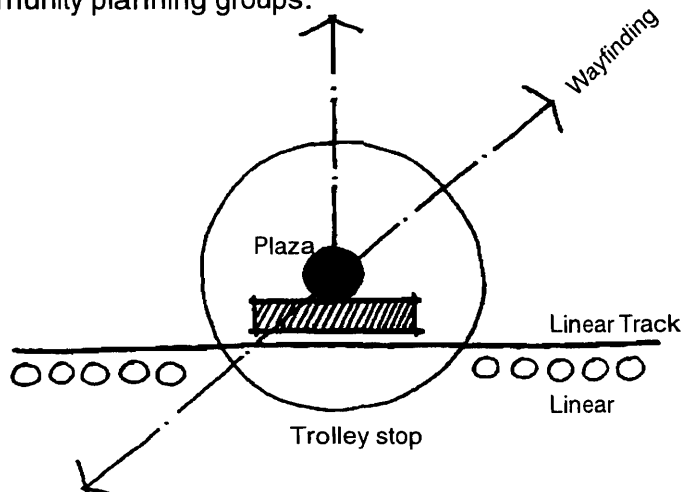

Town Center at Euclid & Market

- ① Reconfigured trolley plaza allows access to trolley cars from either side
- ② Monument sign and plaza orient and inform visitors about the community

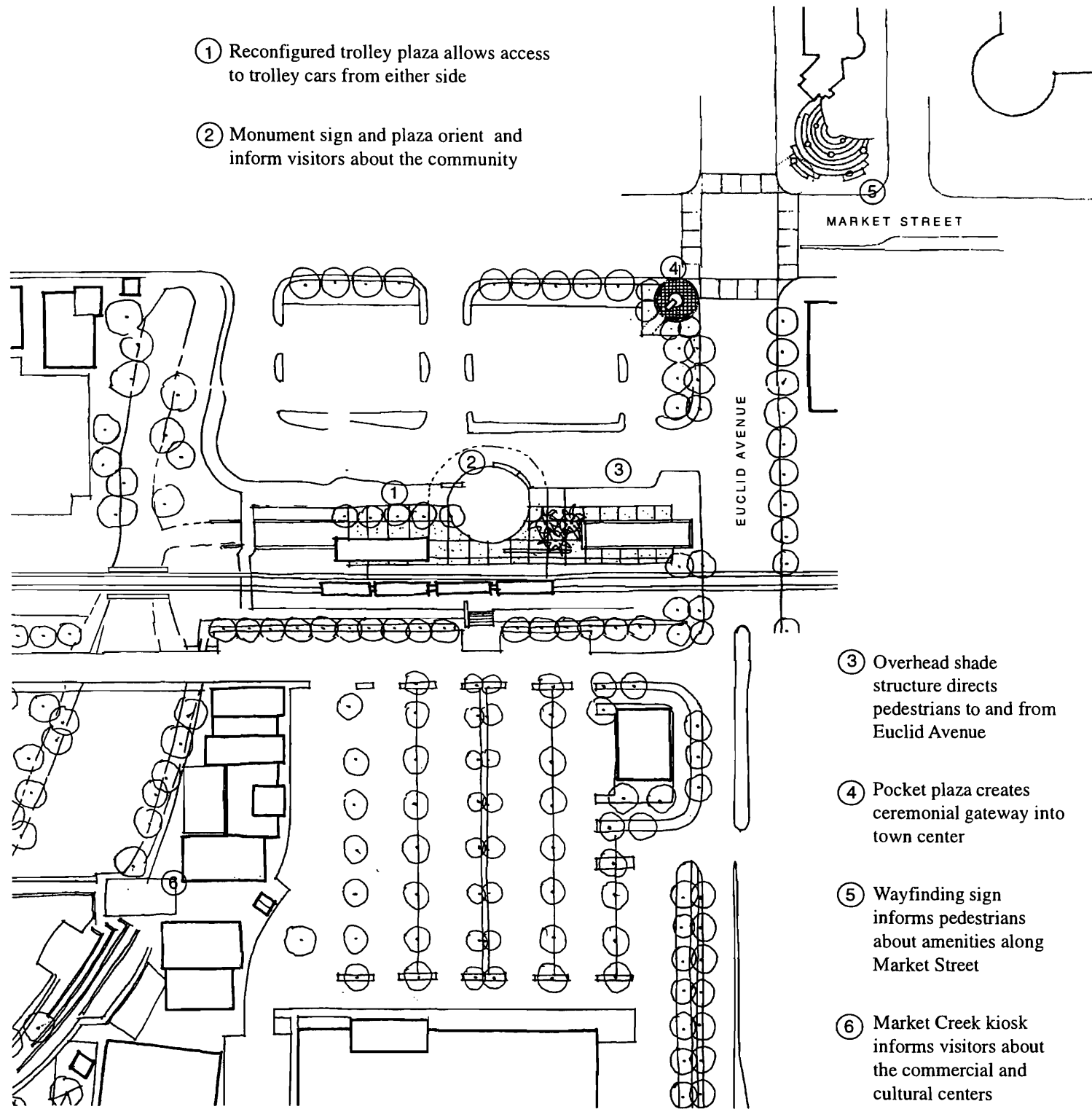

Town Center Plan
NOT TO SCALE

- ③ Overhead shade structure directs pedestrians to and from Euclid Avenue
- ④ Pocket plaza creates ceremonial gateway into town center
- ⑤ Wayfinding sign informs pedestrians about amenities along Market Street
- ⑥ Market Creek kiosk informs visitors about the commercial and cultural centers

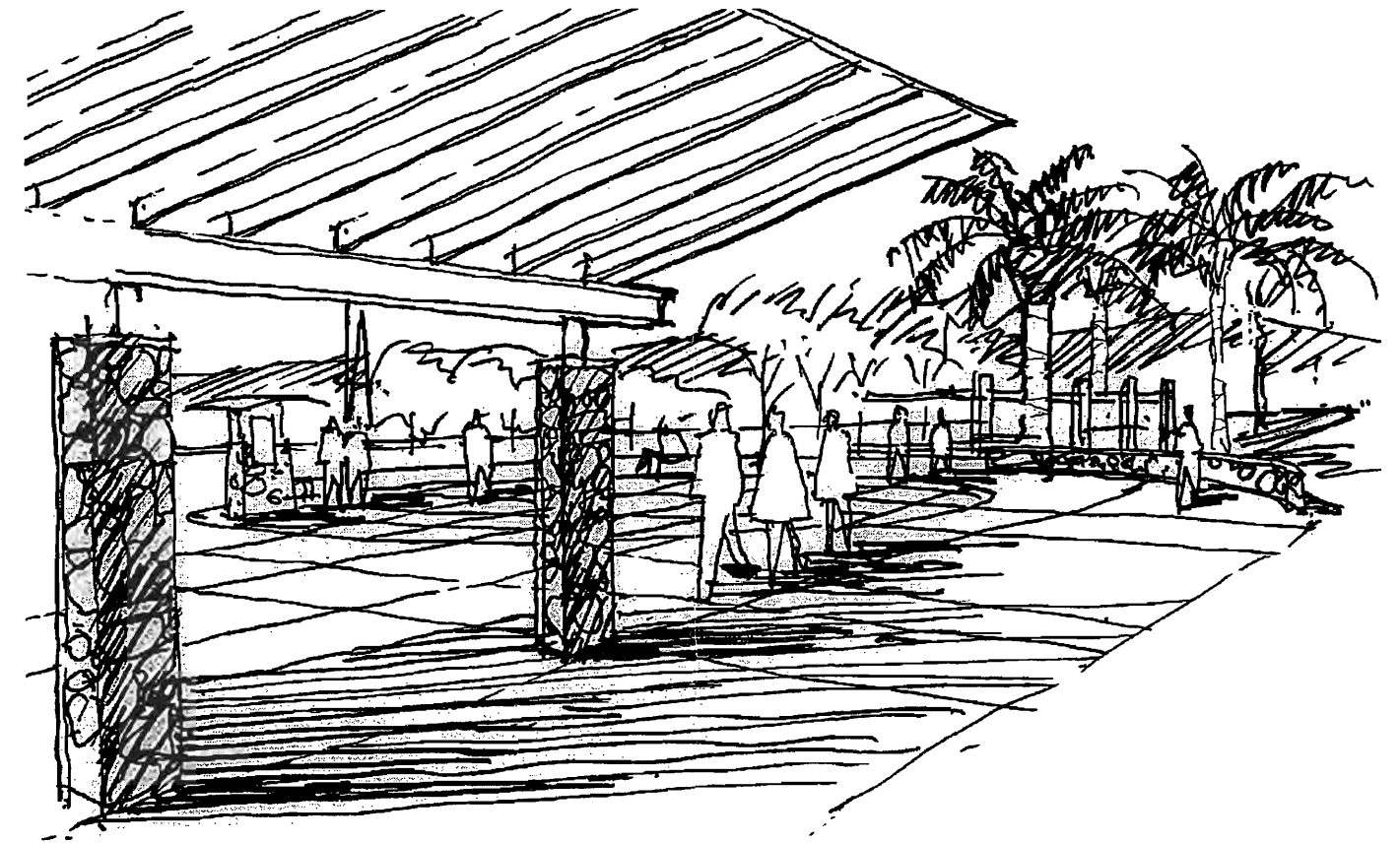

Community Plaza at Town Center

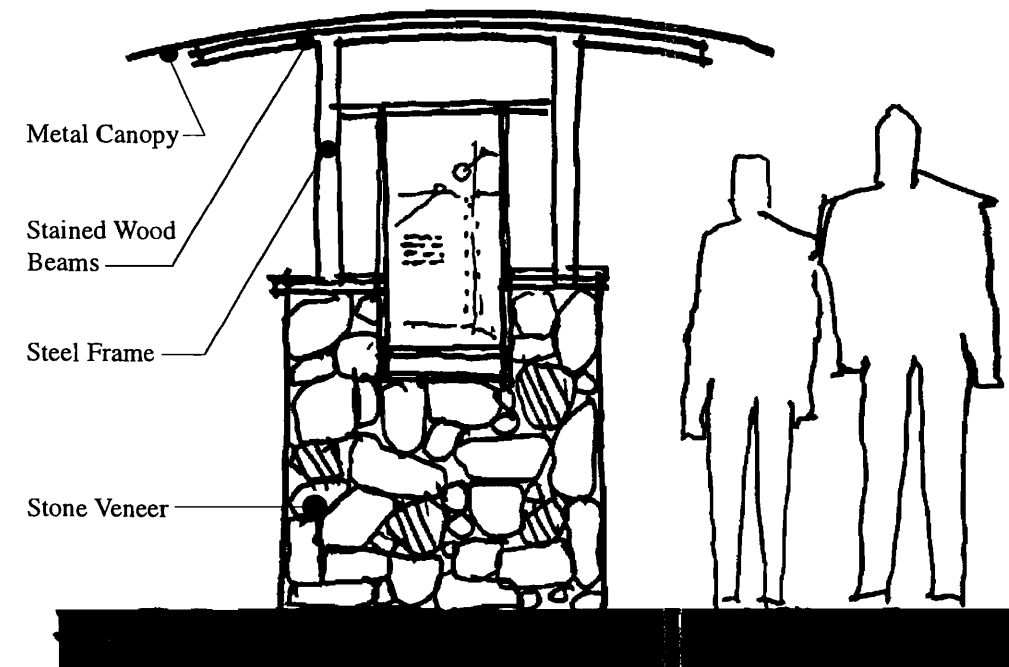

Directional Kiosk

TOWN CENTER AT EUCLID & MARKET

NOT TO SCALE

2.1
FIGURE

CONCEPT DESIGN GUIDELINES

2.3 Euclid Avenue Commercial Corridor

2.3.1 Concept

The design concept for the Euclid Avenue commercial corridor is to strengthen the corridor's image as a "grand" boulevard which is "formal" in design compared to Market Street. (See Figure 2.2).

The corridor should provide a safe and attractive night and day pedestrian experience and should focus on establishing a strong walking link between Imperial Avenue and Market Street.

Gateways at the crossing of Euclid Ave. and Chollas Creek in the north and near St. Rita's church at the south should help establish entries into the district. (See sketch).

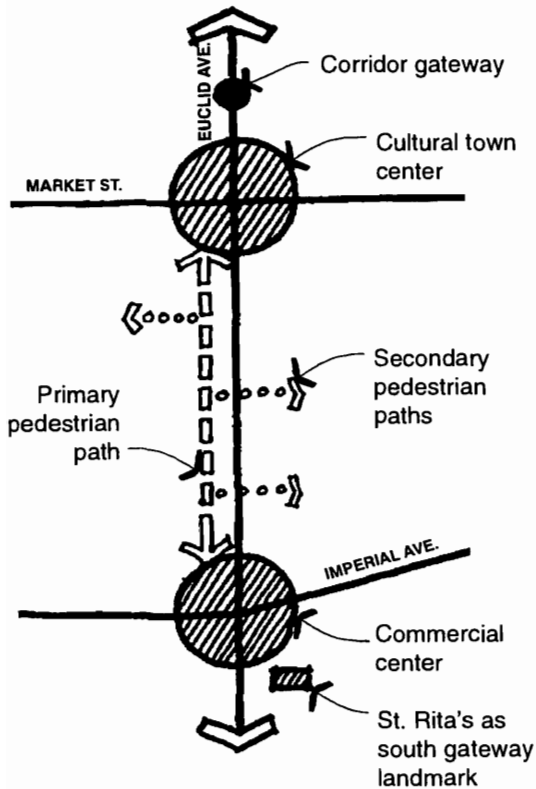

2.3.2 Concept Objectives

- Create guidelines that establish strong commercial links and promote pedestrian day and nighttime activities along Euclid Avenue.
- Promote the use of formal street tree landscaping that addresses the scale and hierarchy of the street as the major east-west link of the area.
- Emphasize residential links with landscaping.
- Landscaping at medians and sidewalks should slow down traffic and create a uniform street appearance.
- Encourage consistency for building facades and signage.

2.3.3 Concept Guidelines

Open Space and Landscaping

Pedestrian crossing zones shall consist of enhanced paved materials and shall incorporate patterns that are consistent with the overall design theme found in the immediate area. Landscaping shall be approved by SEDC and local community planning groups.

Landscape medians along Euclid corridor shall be composed of two types: 1) at areas of illegal crossing potential, median will consist of low wall planters made of poured-in-place concrete with a sandblasted finish. 2) in other areas, medians shall be raised

WALKING PROMENADE

- Make a comfortable walking experience between points of interest and along Euclid Ave.
- Primary pedestrian path focuses on commercial west-side.
- Primary path gets pedestrian to cross street at designated points.
- Secondary pedestrian paths emphasize linkages to adjacent uses.

concrete with enhanced colored paving with landscaping in intermittent areas. (See Figure 2.2).

Designated areas for the placement of public art are encouraged along the corridor. The art shall be approved by SEDC and local community planning groups.

Street furnishings shall reinforce the design theme established in the Town Center.

New pedestrian-oriented lighting along the corridor shall incorporate structural elements to support a banner program.

Exposed retaining walls should be treated with an anti-graffiti application, painted an approved color or covered by landscaping. Where possible, exposed retaining walls should be replaced by landscaped, terraced low walls. (See Figure 2.2).

Architectural Character & Signage

A uniform street setback shall be reinforced by building facades, low walls, fencing and/or landscaping. (See Euclid Avenue Street Section drawing for dimensions on Figure 2.2).

Facade enhancements should help establish business identity and incorporate colors and materials that support the overall design concept. They shall be approved by SEDC and reviewed by local community planning groups and the respective project area committee.

Commercial signage shall comply with the criteria contained within the city-wide sign regulations, Chapter X, Article 1, Division 11 of the Municipal Code. Commercial signage shall consist of two types: 1) building facade signage viewable from the public right-of-way and 2) low-scale, pedestrian-oriented signage that supports the overall concept theme. (See Municipal Code)

Building entries should have adequate exterior lighting and are encouraged to incorporate entry-defining elements such as overhead trellises and awnings.

Euclid Ave. Commercial Corridor

Guideline Objectives:

- Add street furnishings that reinforce theme found in the town center
- Provide lighting that promotes nighttime use of corridor

Guideline Objectives:

- Promote pedestrian activity between intersection nodes
- Reinforce linear corridor with formal landscaping
- Landscaping at medians and sidewalks should slow down traffic and create a uniform street appearance

Guideline Objectives:

- Encourage consistency for building facades and signage
- Commercial development should reinforce pedestrian activity

Site Plan

0 80 160

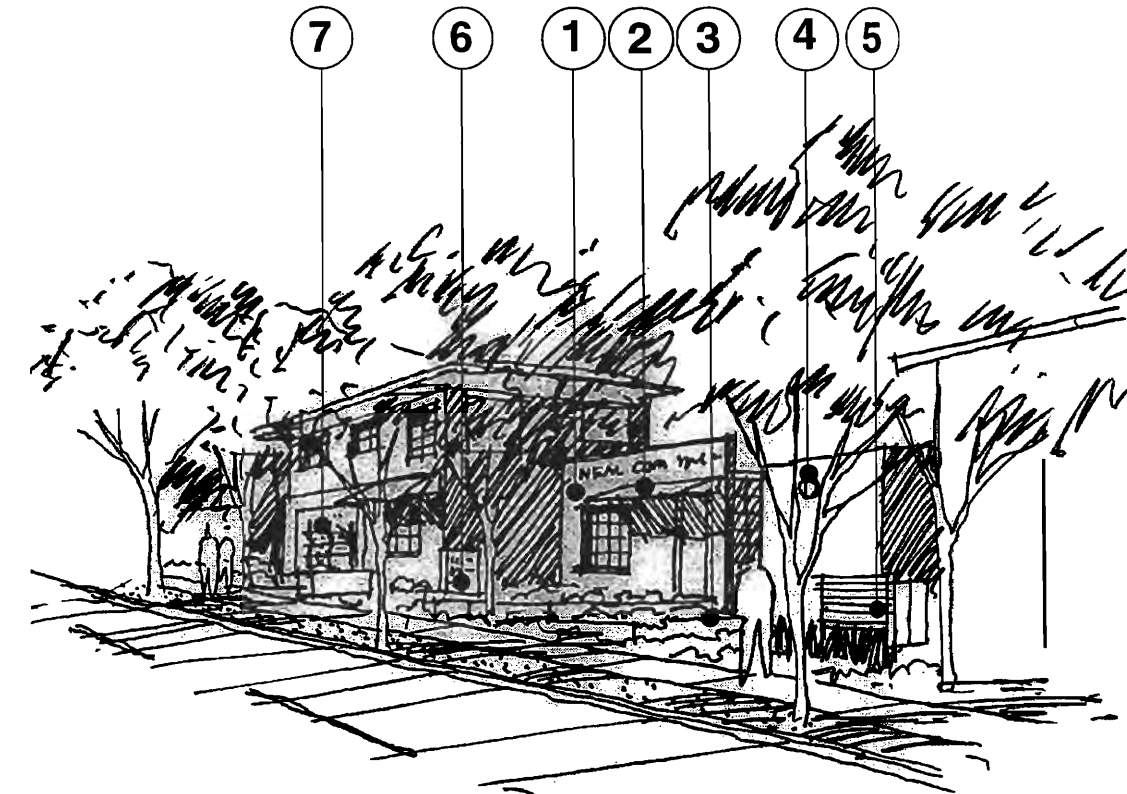
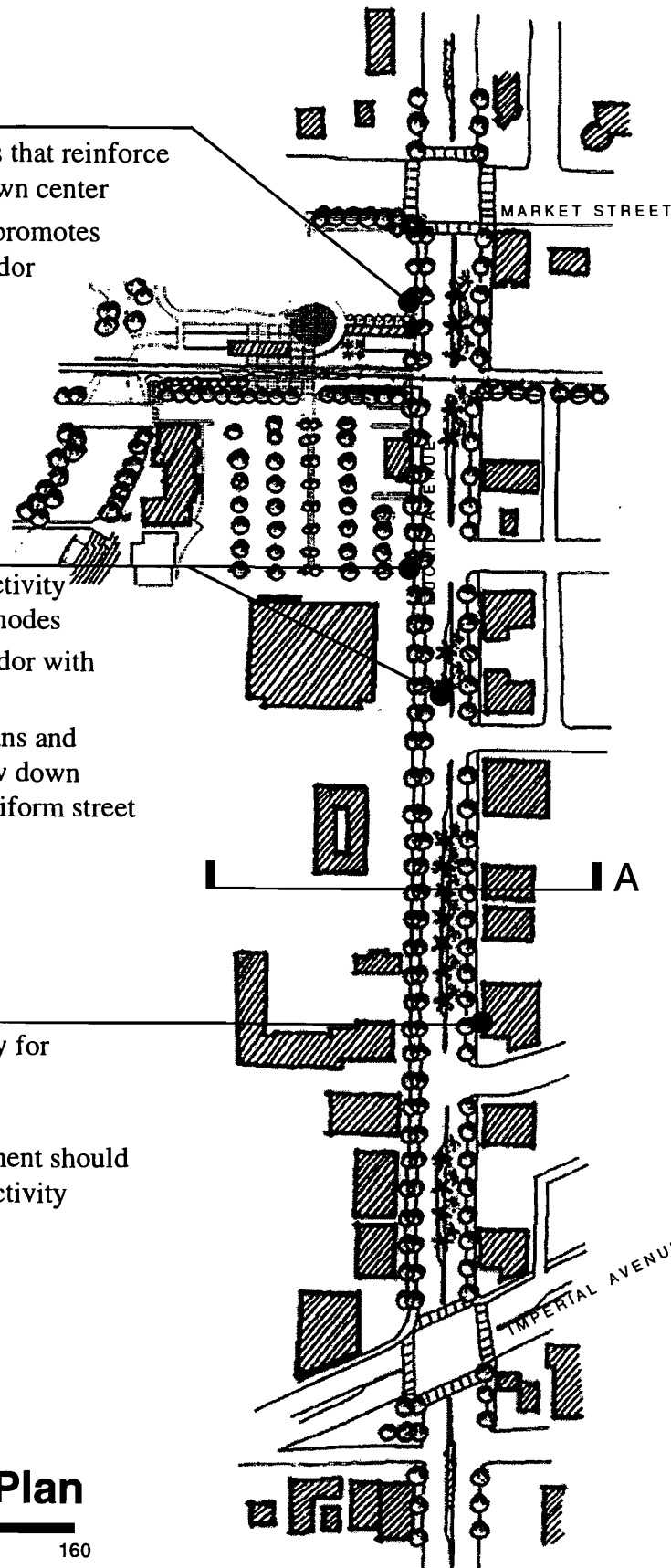

Perspective up Euclid Ave.

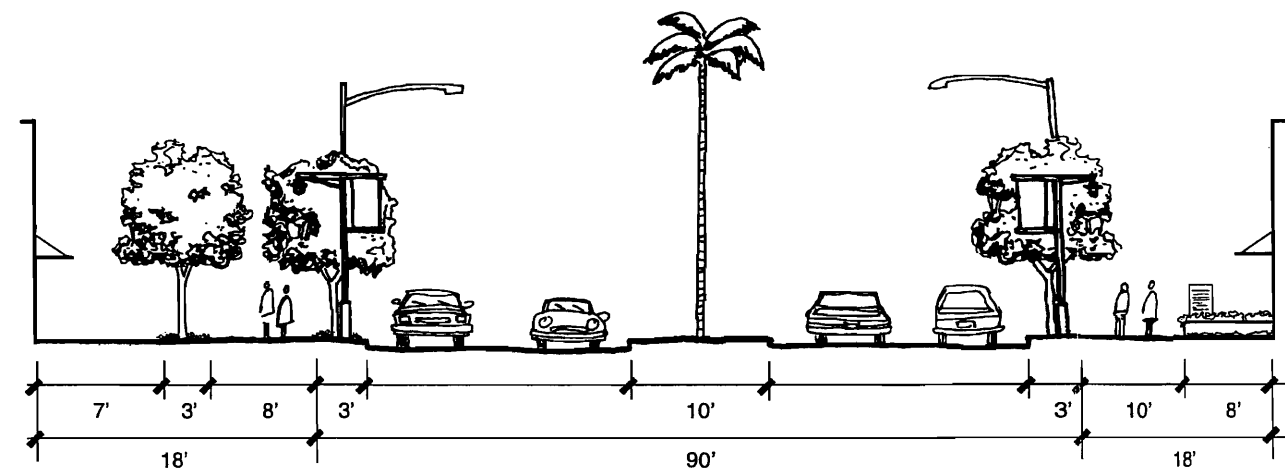

Street Section A

NOT TO SCALE

Commercial Rehabilitation

Standards:

1. Facade enhancements and new storefront windows act as business identity
2. Shade awnings define entry
3. Terraced landscaping replaces retaining walls
4. New exterior lighting promotes safety
5. Screened utility boxes and trash bins
6. Durable signage along sidewalk edge relates to building scale
7. Vine-covered trellis screens define residential entries and create semi-private spaces

EUCLID AVENUE COMMERCIAL CORRIDOR

NOT TO SCALE

2.2
FIGURE

CONCEPT DESIGN GUIDELINES

2.4 Commercial Center at Euclid Avenue and Imperial Avenue

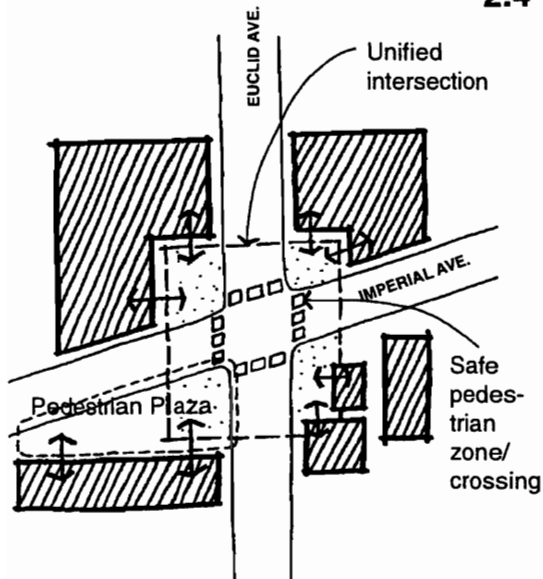

UNIFIED INTERSECTION

- Intersection corners are unified by creating a “formal” open space with pedestrian mini-plazas that serve commercial buildings.

2.4.1 Concept

The Commercial Center at Euclid Avenue and Imperial Avenue serves as the southern terminus of the Euclid Avenue commercial corridor. The intersection should be seen as a pedestrian-friendly community node that provides commercial services that differ from the Euclid and Market node. Uses include retail business and restaurants. The plaza at the southwest corner of the intersection should be enhanced as an open space amenity serving the local businesses.

Landscaping and street reconfiguration should unify the intersection corners, help establish a safe pedestrian crossing zone and create a formal open space that serves as the terminus point for the southern end of the Euclid Avenue commercial district.

2.4.2 Concept Objectives

- Create a consistent building setback, massing and signage program for intersection.
- Improve the pedestrian crossing at intersection.
- Unify the appearance of the intersection to assist in creating a “commercial center”.
- Create an open space public plaza at the southwestern corner of the intersection.
- Provide uniform guidelines for building setbacks, appearance, signage and landscaping.
- Enhance facades with new storefronts, awnings and exterior lighting.
- Reinforce urban street edges with building forms by providing attractive, accessible and safe parking areas at the rear of buildings.

2.4.3 Concept Guidelines

Open Space and Landscaping

Pedestrian crossing zones shall consist of enhanced paved materials and incorporate patterns that are consistent with the overall design theme found in the Town Center. Landscaping shall be approved by SEDC and local community planning groups.

Landscape medians south of Imperial along the Euclid corridor shall replace the existing chain-link fencing and be composed of poured-in-place concrete planters with a sandblasted finished and integral colored textured paving.

Designated areas for the placement of public art are encouraged within the public open space. The art shall be approved by SEDC and reviewed by local community planning groups and the respective project area committee.

Street furnishings shall reinforce the design theme established in the Town Center.

The southwest open space shall be developed as a landscaped restaurant plaza amenity with a water fountain, shade devices, landscaping and seating to support surrounding businesses.

Architectural Character & Signage

A uniform street setback shall be reinforced by building facades, low walls, fencing and/or landscaping. (See section for dimensions on Figure 2.3).

Facade enhancements should help establish business identity and incorporate colors and materials that support the overall design concept and shall be approved by SEDC and reviewed by local community planning groups and the respective project area committee.

Commercial signage shall comply with the criteria contained within the city-wide sign regulations, Chapter X, Article 1, Division 11 of the Municipal Code. Commercial signage shall consist of two types: 1) building facade signage viewable from the public right-of-way and 2) low-scale, pedestrian-oriented signage that supports the overall concept theme. (See Municipal Code).

Building entries should have adequate exterior lighting and are encouraged to incorporate entry-defining elements such as overhead trellises and awnings.

2.5 Market Street Commercial Industrial Corridor

2.5.1 Concept

The Market Street Commercial Industrial Corridor extends from 47th street at the west end to 54th Street at the east. The concept is to enhance the area as a commercial industrial park that has features and amenities unique from any other industrial park in San Diego. This unique identity is partly attributed to:

- its close proximity to the Town Center at Market Street and Euclid Avenue.
- close proximity to the cultural learning centers of the Malcolm X Library, the Elementary Institute of Science, and the Tubman Chavez Community Center that share the corridor.
- the natural open space beauty north of the project site.
- its retained rural feel.

This corridor has the potential to create a partnership between the cultural learning centers and local commercial businesses. A partnership can be achieved by:

- Creating a walking environment that produces a seamless experience of cultural/learning centers and commercial businesses.
- Both groups emphasizing protection of open space as a unique amenity.
- Trolley corridor announcing both learning centers and commercial businesses through landscaping.
- Wayfinding elements listing both uses.

2.5.2 Concept Objectives

- Enhance the business park theme to become a showcase model for a transit-oriented redevelopment environment for San Diego.
- Retain and utilize the open space areas as site amenities and attractions.
- Develop a pedestrian-friendly environment.
- Retain a rural feeling with its sense of open space.
- Develop pedestrian and bicycle paths along the street.
- Plant natural indigenous and durable landscaping along street edges.

- Create a pleasant and unique sense of arrival and identity along the trolley line corridor.
- Direct the trolley corridor to become a green space by promoting building and site improvements.
- Develop pedestrian “nature” walkway along northern edge of Market Street.

2.5.3 Design Guidelines

Open Space and Landscaping

Pedestrian paths on both sides of Market Street shall consist of well-lighted and safe concrete surfacing. Landscaping shall be approved by SEDC and reviewed by local community planning groups and the respective project area committee.

Pedestrian paths on the south side of Market Street shall be formal linear paths of no less than 8'-0" in width and shall be lit at nighttime with pedestrian-scaled lamps. (See Figure 2.4).

Pedestrian paths on the north side of Market Street shall be informal meandering paths that support the natural open space theme proposed. Lighting shall consist of light bollards. (See Figure 2.4).

PARTNERSHIP BETWEEN LEARNING CENTERS AND COMMERCIAL BUSINESSES

- Walking environment creates a seamless experience of cultural/ learning centers and commercial businesses.
- Both groups emphasize protection of open space as a unique amenity.
- Trolley corridor announces both learning centers and commercial businesses through landscaping.

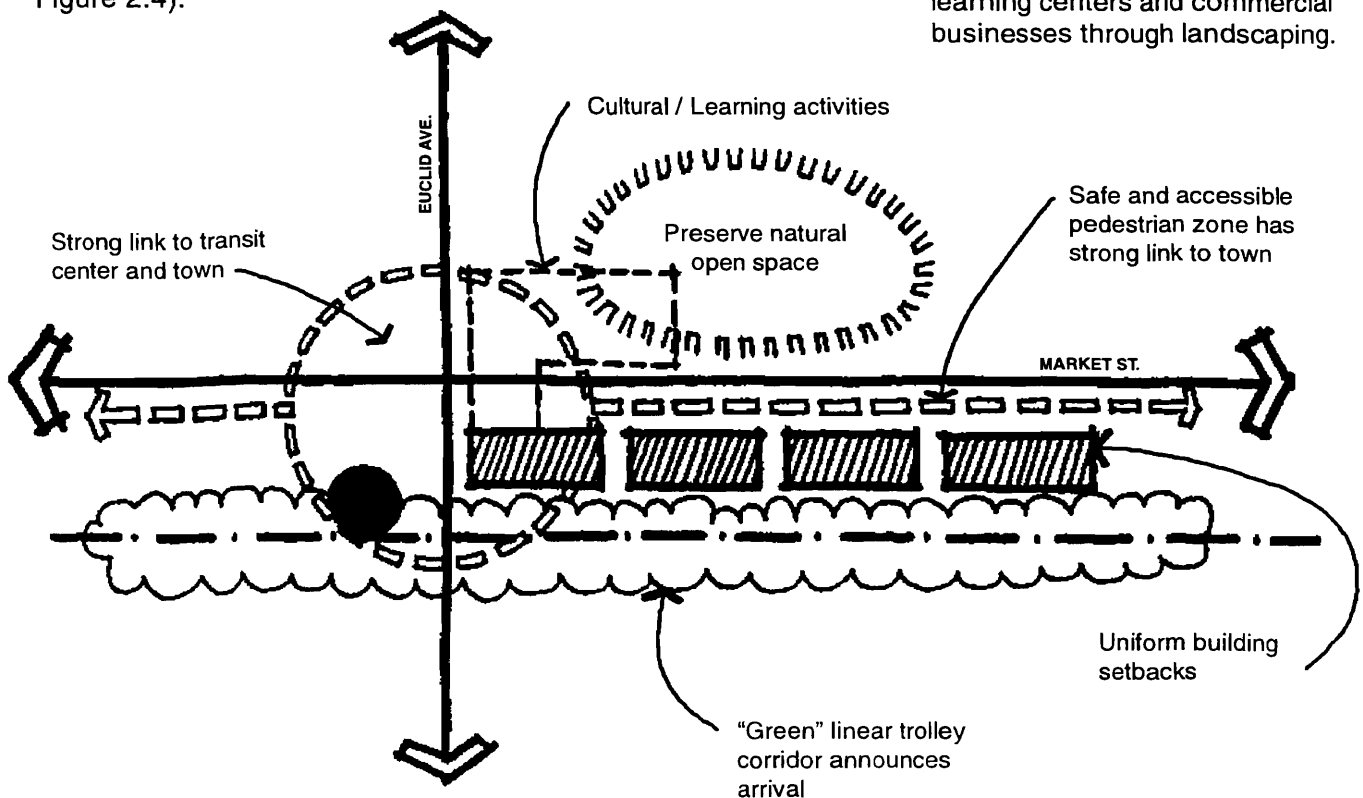

Landscape medians along Market Street between 47th Street and 54th Street shall be composed of poured-in-place-concrete planters with a sandblasted finish and integrally-colored textured surface paving.

Designated areas for the placement of public art are encouraged within the public open space. The art shall be approved by SEDC and reviewed by local community planning groups and the respective project area committee.

Street furnishings shall reinforce the design theme established in the Town Center.

Trolley Corridor

To establish a “green zone” along the trolley corridor, rear private property lots should screen parking and open spaces with landscaping, vine-covered trellis carports, vine-covered fencing, and/or low walls that establish property setbacks.

Views to rear building signage should be allowed.

All general design guidelines found in Section 3 that apply to building maintenance, trash enclosures, graffiti, and storage shall apply to rear lots of properties along the corridor.

Architectural Character & Signage

Facade enhancements should help establish business identity and incorporate colors and materials that support the overall design concept and shall be approved by SEDC and reviewed by local community planning groups and the respective project area committee.

Commercial signage along the Market Street Commercial Industrial Corridor shall comply with the criteria contained within the city-wide sign regulations, Chapter X, Article 1, Division 11 of the Municipal Code. (See Municipal Code).

Commercial signage shall consist of two types: 1) building facade signage viewable from the public right-of-way and trolley corridors and 2) low-scale, pedestrian-oriented signage that supports the open space concept theme.

Building entries should have adequate exterior lighting and are encouraged to incorporate entry-defining elements such as overhead trellises and awnings.

INTENTIONAL BLANK PAGE

Market Street Commercial Industrial Corridor

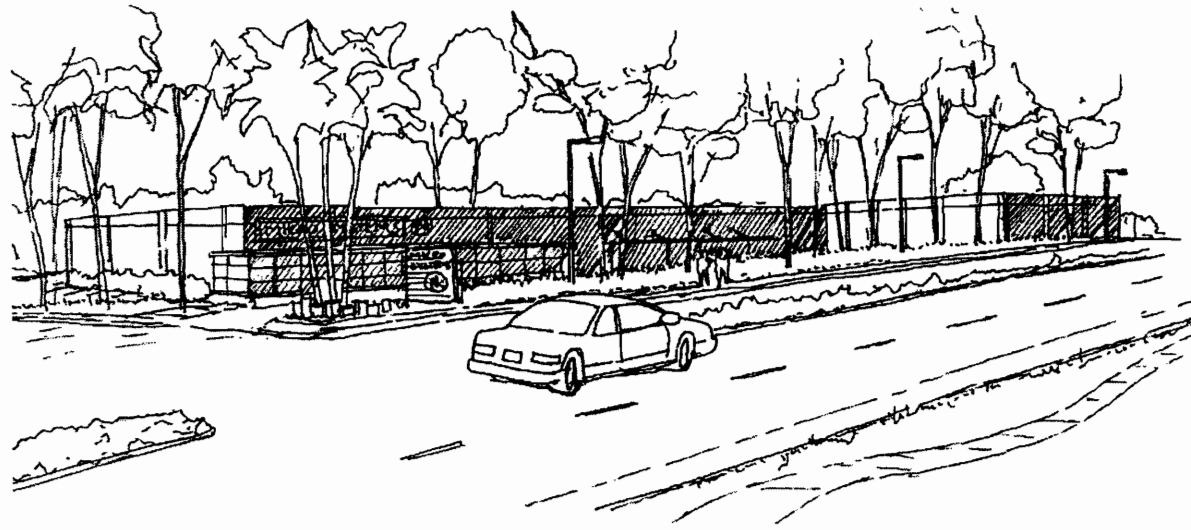

Perspective looking west on Market St. & 54th

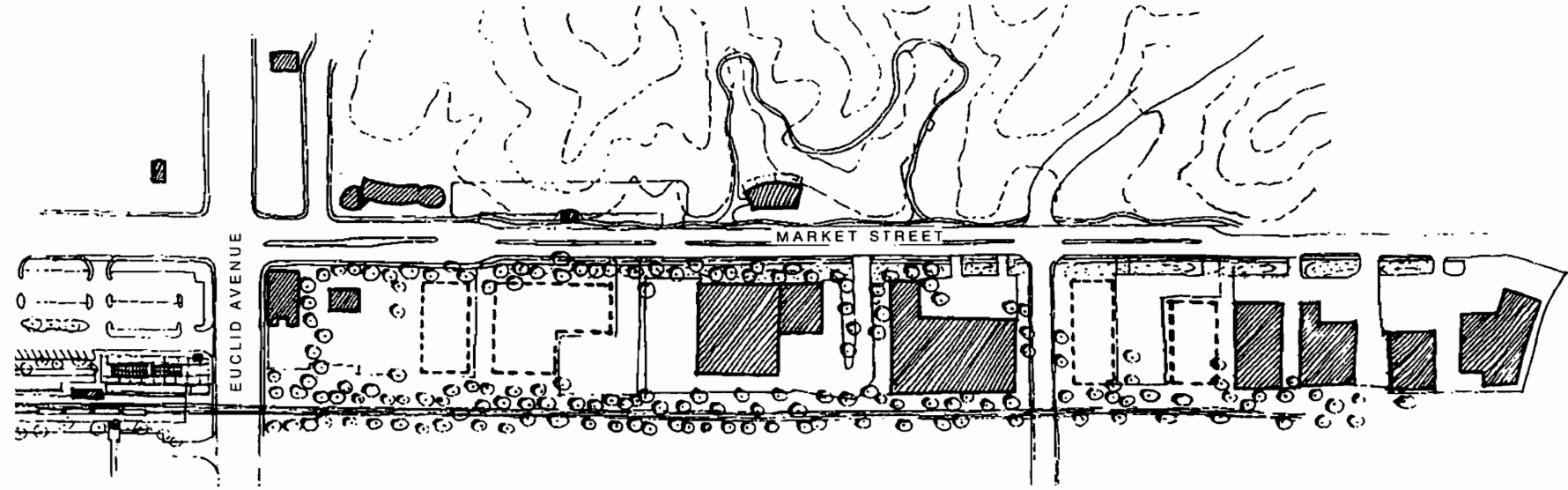

Partial Site Plan

0 100 200 400

Guideline Objectives:

- Retain and enhance rural/open space feeling
- Add street landscape medians and site furnishings

Guideline Objectives:

- Develop safe well-lighted pedestrian and bicycle paths
- Locate utilities underground

Guideline Objectives:

- Provide uniform guidelines for building setbacks, appearance, signage and landscaping

Guideline Objectives:

- Screening from trolley
- Parking
- Rear lot landscaping

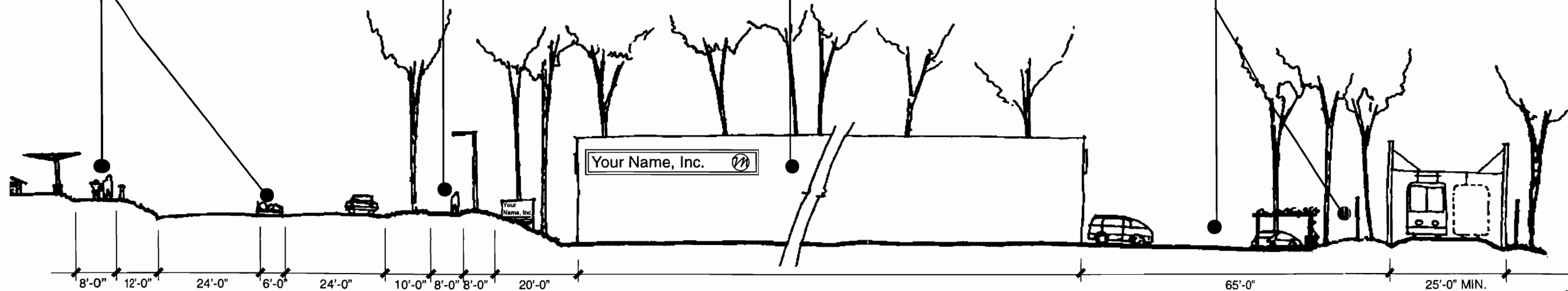

Street Section

0 10 20 40

MARKET STREET COMMERCIAL INDUSTRIAL CORRIDOR

NOT TO SCALE

CONCEPT DESIGN GUIDELINES

2.4
FIGURE

2.6 Encanto Village at Imperial Avenue

2.6.1 Concept

The area known as Encanto Village, which encompasses the Imperial Avenue commercial corridor between 61st and 69th Streets, should focus itself on becoming a unique pedestrian-oriented commercial and residential enclave within the entire avenue corridor.

The unique features that define the “Encanto Village” are its low-scale street-front, and older commercial buildings that feature a “historic” identity. This environment along with the nearby Encanto Trolley Station is conducive to a pedestrian-oriented entertainment theme of restaurants, clubs and shops.

To increase density and promote day and nighttime uses, multifamily or work/live residential development along with safe and ample parking areas should be encouraged as infill projects between the existing buildings.

2.6.2 Concept Objectives

- Strengthen pedestrian crossings from Akins Street.
- Unify building edges along the southern street edge of Imperial Avenue.
- Create safe parking opportunities along Imperial Avenue.
- Develop signage standards.
- Prescribe building setbacks and height limits.
- Promote “Village Entertainment District” destination.
- Allow mixed commercial and residential use.

2.6.3 Concept Guidelines

Open Space and Landscaping

The pedestrian zone along the south side of Imperial Avenue shall be strengthened by enhancing the off-street parking zones that separate the street from the sidewalk.

Setbacks shall be maintained and strengthened with building facades, low walls, and landscaping (See Figure 2.5).

Slow down traffic along corridor and encourage off-street parking by defining parking zones

Provide attractive and safe parking areas (40-60 vehicles) on open space lots.

Trolley Corridor

Establish a "green zone" along the trolley corridor by continuing plant-covered fencing where applicable.

All general design guidelines found in Section 3 regarding building maintenance, trash enclosures, graffiti, and storage shall apply to commercial and private properties along the corridor.

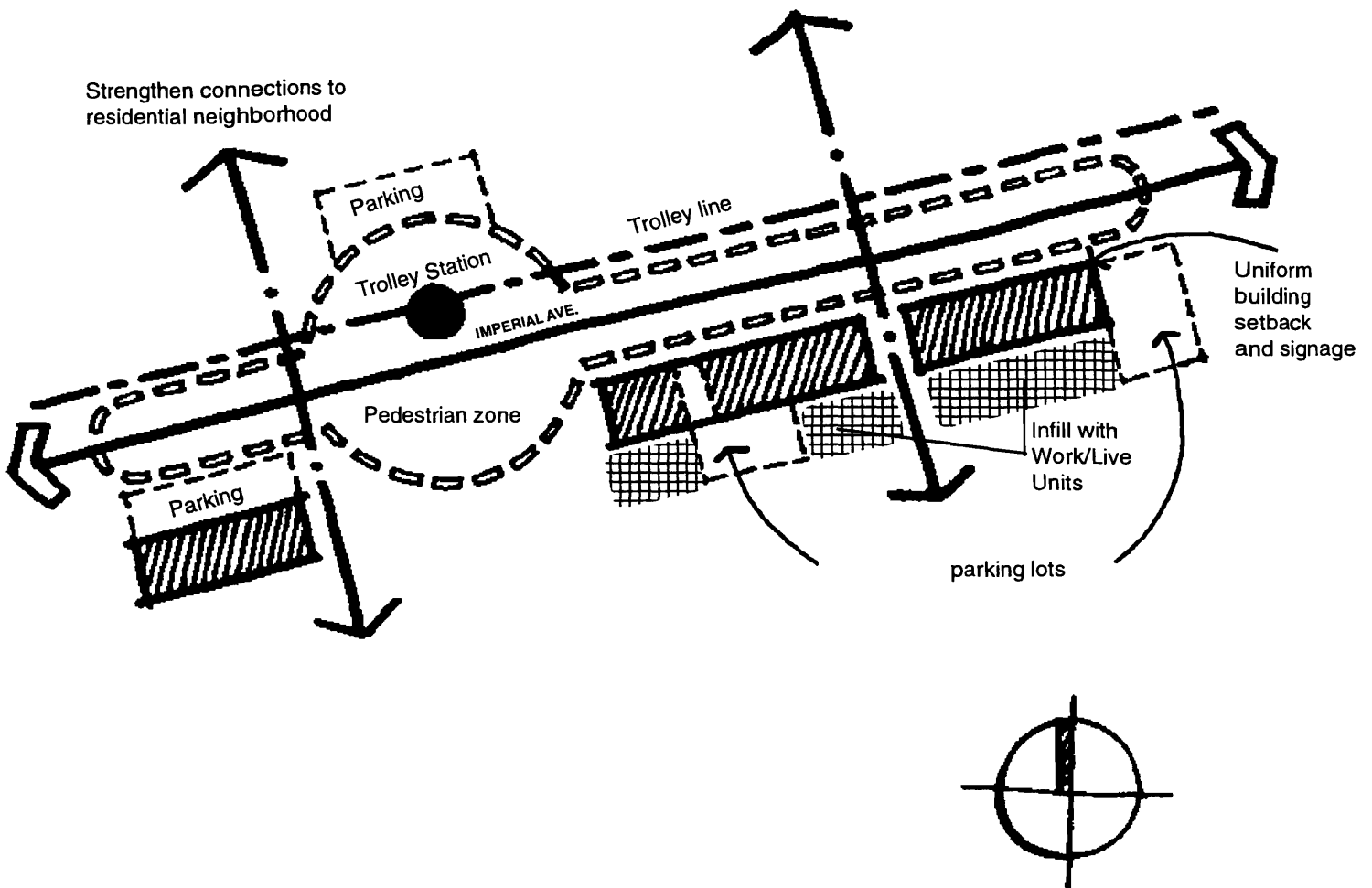

Architectural Character & Signage

Promote in-fill developments that increase density and reinforce a pedestrian-oriented destination “theme” node.

Infill development and renovation of existing buildings shall respect the historic character, setback, building materials, colors, scale and size of existing structures between 61st and 69th Streets.

All new development and redevelopment activities shall be approved by SEDC and reviewed by local community planning groups and the respective project area committee.

Facade enhancements should help establish business identity and incorporate colors and materials that support the overall design concept and be approved by SEDC and reviewed by local community planning groups and the respective project area committee. (See Figure 2.5).

Where feasible, raised planters should be incorporated along the pedestrian zone on storefront or window ledges. (See Figure 2.5).

Commercial signage along the Imperial Avenue Corridor shall comply with the criteria contained within the city-wide sign regulations, Chapter X, Article 1, Division 11 of the Municipal Code. (See Municipal Code).

Commercial signage shall consist of two types: 1) building facade signage viewable from the public right-of-way and trolley corridors and 2) low-scale, pedestrian-oriented signage that supports the open space concept theme. (See Figure 2.5).

Building entries should have adequate exterior lighting and are encouraged to incorporate entry-defining elements such as overhead trellises and awnings.

INTENTIONAL BLANK PAGE

Encanto Village at Imperial Avenue

Guideline Objectives:

- Develop safe well-lighted pedestrian and bicycle paths

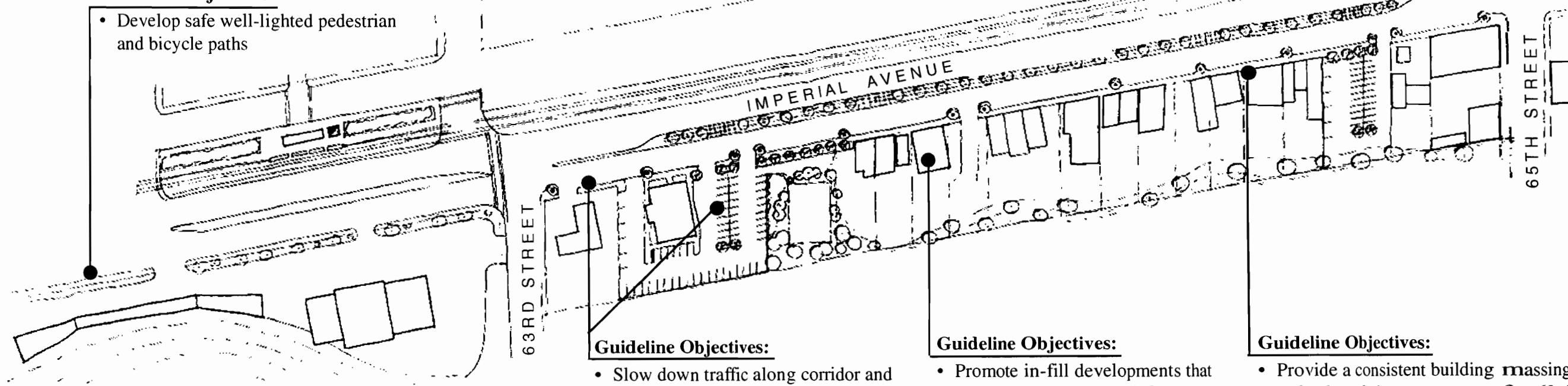

Guideline Objectives:

- Slow down traffic along corridor and encourage off-street parking by defining parking zones
- Provide attractive and safe parking areas/lots (40-60 vehicles)

Guideline Objectives:

- Promote in-fill developments that increase density and reinforce a destination "theme" node

Guideline Objectives:

- Provide a consistent building massing, setback and signage program for 63rd through 69th St.

Imperial Avenue Partial Plan

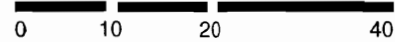

Commercial Rehabilitation Standards:

1. Refinish exterior facades to original condition
2. Optional side porch
3. Add planters along public spaces
4. Sidewalk-oriented signage and lighting
5. Awnings define pedestrian space
6. New storefront

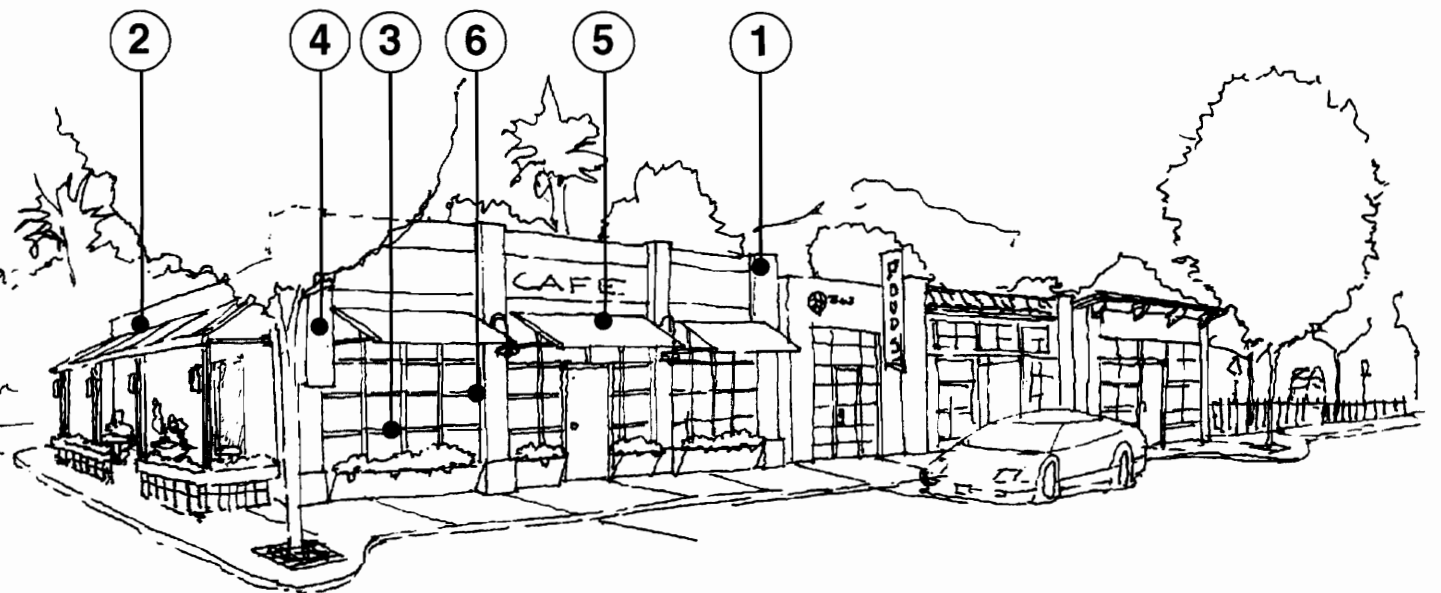

Perspective near 63rd and Imperial

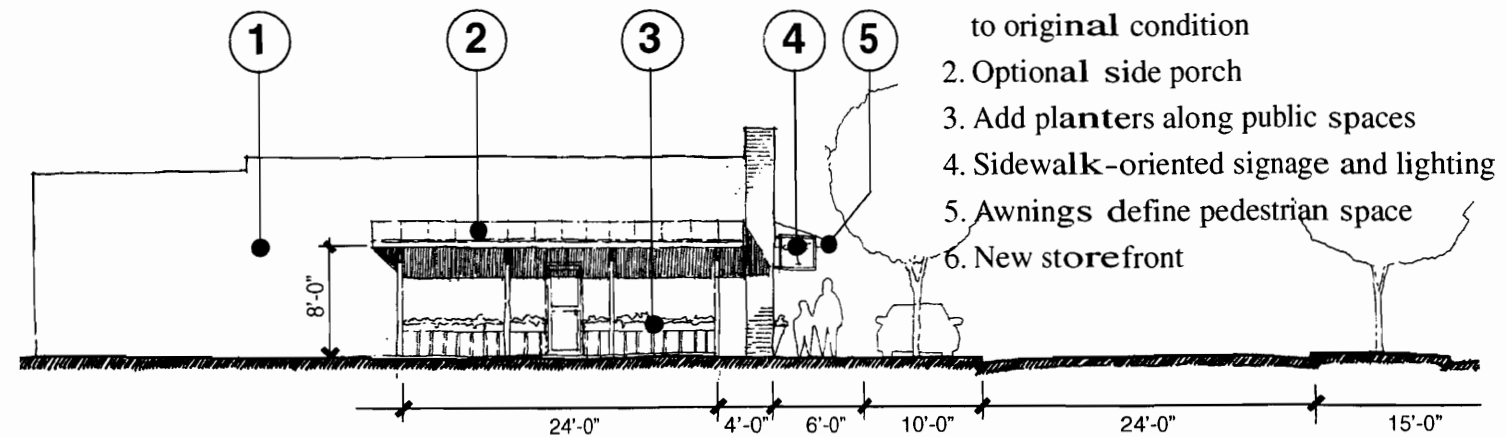

Partial Street Section near 63rd and Imperial

NOT TO SCALE

ENCANTO VILLAGE AT IMPERIAL AVENUE

NOT TO SCALE

CONCEPT DESIGN GUIDELINES

2.5
FIGURE

2.7 Mount Hope Commercial Corridor

2.7.1 Concept

This Market Street corridor bounded by 41st Street and Interstate 805 serves as the eastern commercial gateway into the Mount Hope area. The concept is to build upon the area's existing low-scale commercial theme through creating a traditional "main street" identity. The "main street" identity is partly defined by low-scale commercial buildings along the street corridor with links to the residential neighborhoods directly beyond the buildings.

This identity is enhanced by creating pedestrian-friendly zones along building storefronts, adding safe parking areas in back of commercial businesses, and providing formal landscaped medians with that helps slows automobile traffic along the five block zone. (See sketch on Pg. 2-30).

2.7.2 Concept Objectives

- Create a Market Street "East Gateway" off Interstate 805.
- Create a low-scale, pedestrian-friendly commercial environment.
- Provide uniform guidelines for building set backs and private property landscaping.
- Provide uniform guidelines for building setbacks, appearance, signage and landscaping.
- Enhance facades with new storefronts, awnings and exterior lighting.

2.7.3 Concept Guidelines

Open Space and Landscaping

A "Gateway" median off of I-805 should be enhanced to establish a gateway identity, slow traffic, and create more landscaping surface area.

Slow down traffic along the corridor with the use of landscape medians and encourage off-street parking by defining parking zones.

Reinforce urban street edges with building forms by providing attractive, accessible and safe parking areas at the rear of buildings.

Provide landscape treatments at side streets to enhance connections to residential neighborhoods.

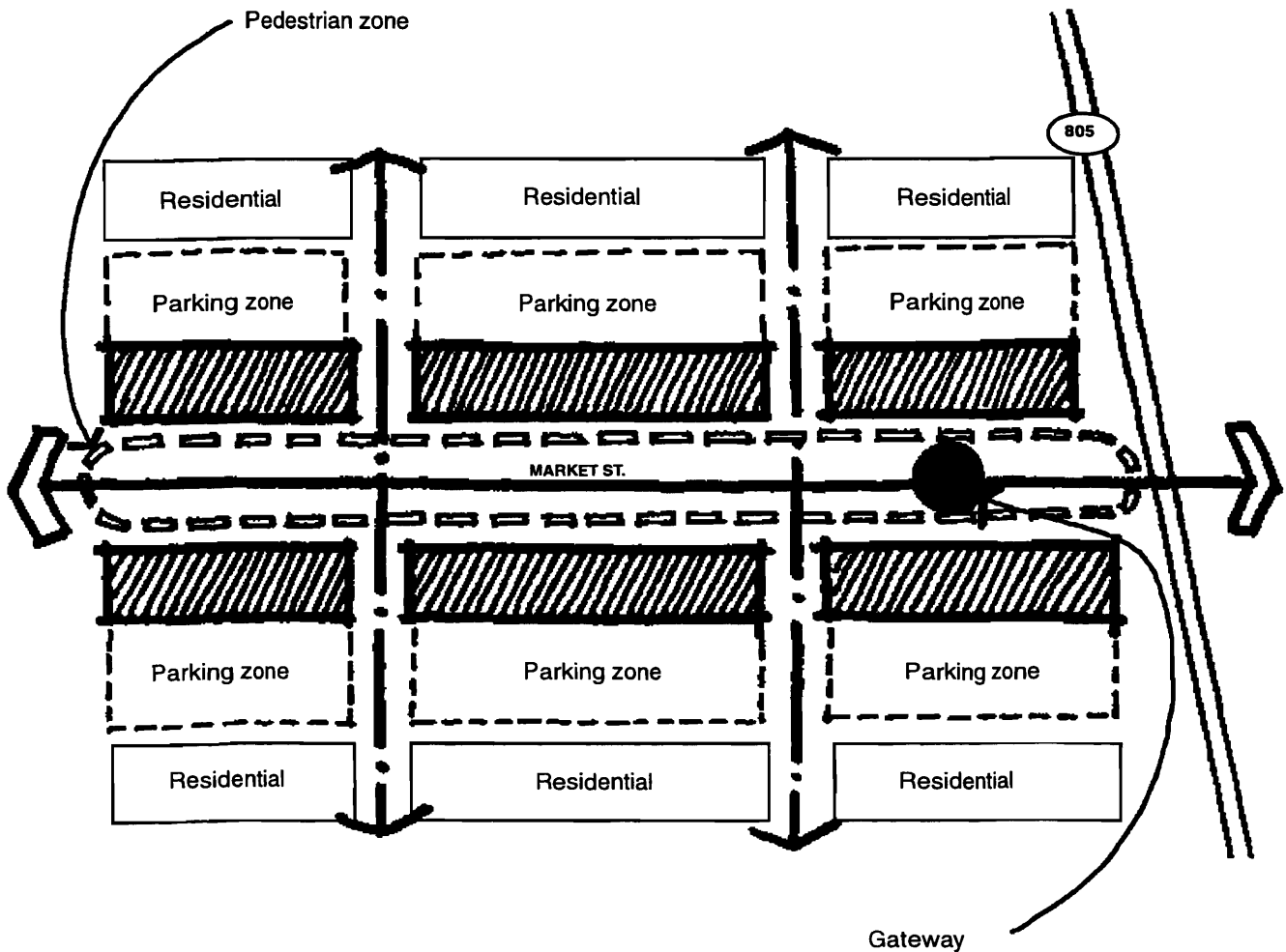

Architectural Character & Signage

Promote in-fill developments that increase density and reinforce a pedestrian-oriented destination "theme".

Setbacks shall be maintained and strengthened with building facades, low walls, and landscaping (See Figure 2.6).

Infill development and renovation of existing buildings shall respect the street character, setback, building materials, colors, scale and size of existing structures between 41st and Interstate 805.

All new development and redevelopment activities must be approved by SEDC and reviewed by local community planning groups and the respective project area committee.

Facade enhancements should help establish business identity and incorporate colors and materials that support the overall design concept and should be approved by SEDC and reviewed by local community planning groups and the respective project area committee. (See Figure 2.6).

Building openings, such as windows, storefronts, and exterior lighting shall be placed along side facades to promote safety and accessibility off side streets where applicable.

Commercial signage along the Mount Hope Commercial Corridor shall comply with the criteria contained within the city-wide sign regulations, Chapter X, Article 1, Division 11 of the Municipal Code. (See Municipal Code).

Commercial signage shall consist of two types: 1) building facade signage viewable from the public right-of-way and 2) low-scale, pedestrian-oriented signage that supports the concept theme. (See Figure 2.6).

INTENTIONAL BLANK PAGE

Mount Hope Commercial Corridor

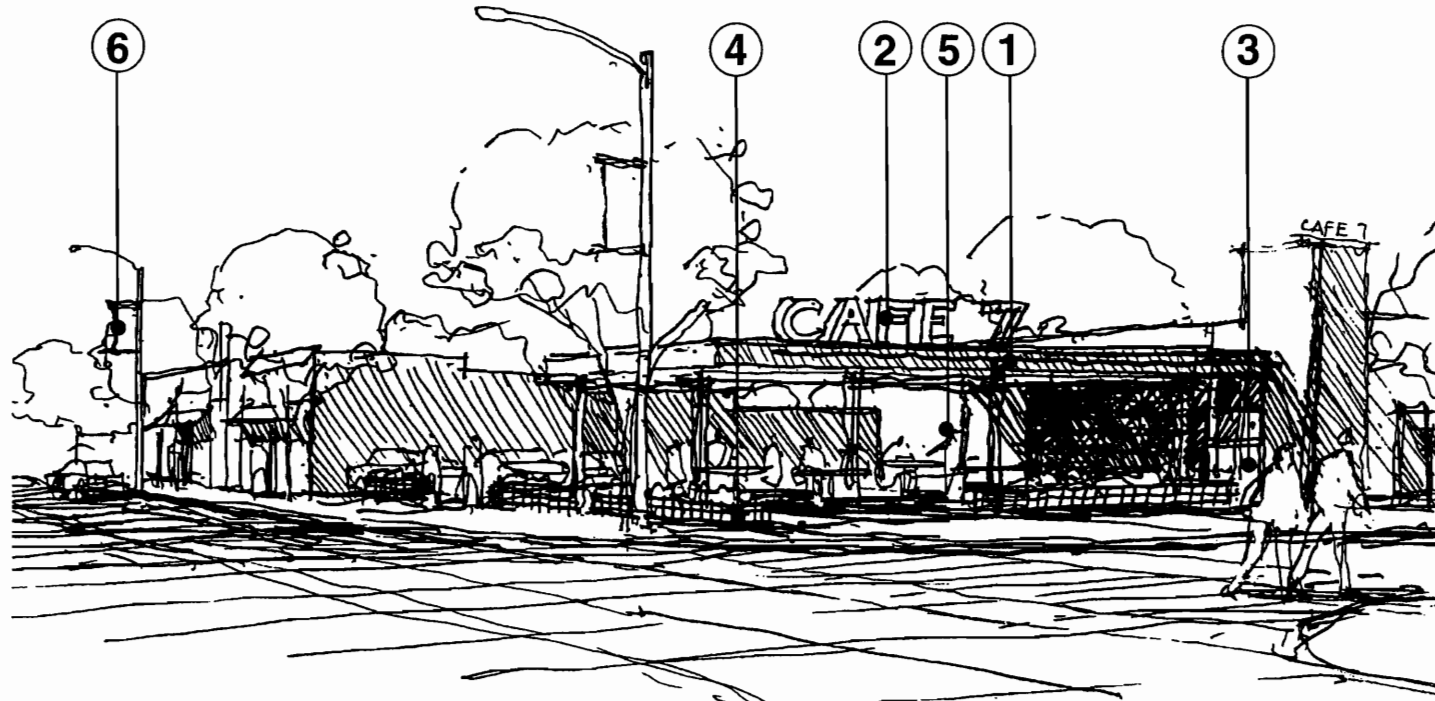

Commercial Rehabilitation Standards:

1. Renovate, add, or repaint shade structures/awnings
2. Update commercial signage and exterior lighting
3. Facade enhancements and new storefront windows
4. Add planter low walls and landscaping to help define sidewalk edges
5. Create uses to promote outdoor commercial activity
6. Encourage the use of banners to promote community identity
7. Screened utility boxes and trash bins from street

Perspective of Toyne & Market

Guideline Objectives:

- Provide side-street building openings and lighting to promote safety
- Provide landscape treatments at side streets to enhance connections to residential neighborhoods

Guideline Objectives:

- Develop safe well-lighted pedestrian paths
- Locate utilities underground
- Create "gateway" median off I-805

Guideline Objectives:

- Provide uniform guidelines for building setbacks, appearance, signage and landscaping
- Enhance facades with new storefronts, awnings and exterior lighting

Guideline Objectives:

- Reinforce urban street edges with building forms by providing attractive, accessible and safe parking areas at rear of buildings

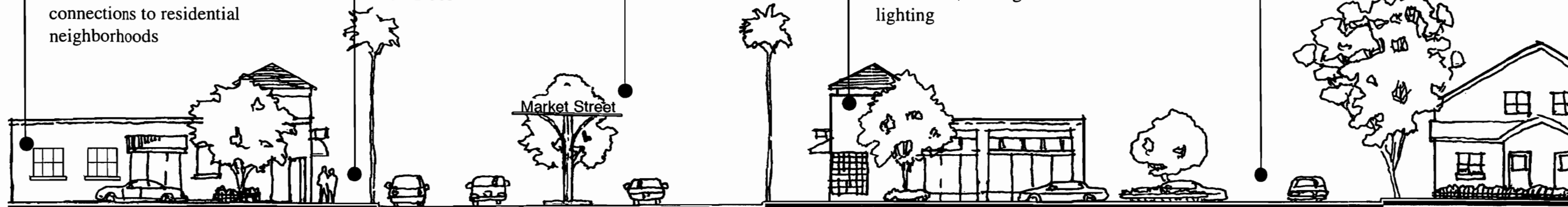

Market Street Section

MOUNT HOPE COMMERCIAL CORRIDOR

NOT TO SCALE

CONCEPT
DESIGN GUIDELINES

2.6
FIGURE



Section 3 Design Criteria and Guidelines

3.0 Purpose and Intent

The Design Criteria and Guidelines provide planning and design standards that ensure commercial redevelopment and improvements conform to a high level of commercial environmental design excellence.

This section presents design criteria and guidelines that are specific in nature. The guidelines provide commercial property and business owners direction and assistance in reaching “design standard goals”.

Design criteria and guidelines are unlike the redevelopment concepts presented in Section 2. Instead, they are applied throughout the redevelopment Project Areas district, unless otherwise noted. The design criteria and guidelines are developed for property and business owners to help them meet design requirements that create vital and active commercial districts.

This section is divided into seven design subsections: Land Use, Architectural Character, Landscaping, Circulation and Parking, Property Maintenance, Signage, Site Furnishings, and Lighting and Utilities.

3.1 Applicable Areas

Applicable areas for the regulatory guidelines are within the SEDC Redevelopment Project Areas and include the three commercial nodes and three commercial corridors outlined below:

Commercial Nodes

- Town Center at Euclid Avenue and Market Street.
- Euclid Avenue and Imperial Avenue Commercial Center.
- Encanto Village at Imperial Avenue (includes corridor from 61st Street to 69th Street).

Commercial Corridors

- Euclid Avenue Commercial Corridor between Martin Luther King, Jr. Freeway 94 and Imperial Avenue.
- Market Street Commercial Industrial Corridor from 47th Street to 54th Street.
- Mount Hope Commercial Corridor along Market Street between Interstate 805 and 41st Street.

3.1.1 Applicable Standards

The following standards and recommendations were applied in developing the design criteria and guidelines and should be consulted for additional information: The City of San Diego Zoning Ordinance, Applicable Zoning Maps supplied by the City of San Diego Planning Department, Southeast San Diego Planned District Ordinance and the Market Street Corridor Urban Design Study (see Section 4 “Resource Guide” for a complete list).

The design criteria and guidelines are intended to be applied to existing commercial businesses, future commercial development and public right-of-way infrastructure. The guidelines are specifically tailored for the individual commercial redevelopment mission of the community and physical settings of Southeastern San Diego.

3.2 Land Use

3.2.1 General Objectives

Uses permitted within the redevelopment districts are governed by the underlying commercial and industrial zone regulations. However, all proposed uses are subject to approval by SEDC and the City of San Diego Planning Department.

The intent of the land use criteria guidelines is to achieve vital commercial districts that:

- Conform to the Land Use Plan described by the City of San Diego.
- Provide maximum employment opportunities for local residents.
- Provide uses that accommodate the redevelopment concepts or themes per area (See Sections 2.1 to 2.7).
- Provide land uses that reduce or minimize energy consumption.
- Provide uses that accommodate the scale and commercial activity proposed per individual commercial area (See Sections 2.1 to 2.7).

3.2.1 Design Criteria & Guidelines

Land use guidelines are provided in graphic format to ensure that accepted redevelopment goals are met through the various uses of commercial property. Figures 3.1 and 3.2 graphically display the land use guidelines.







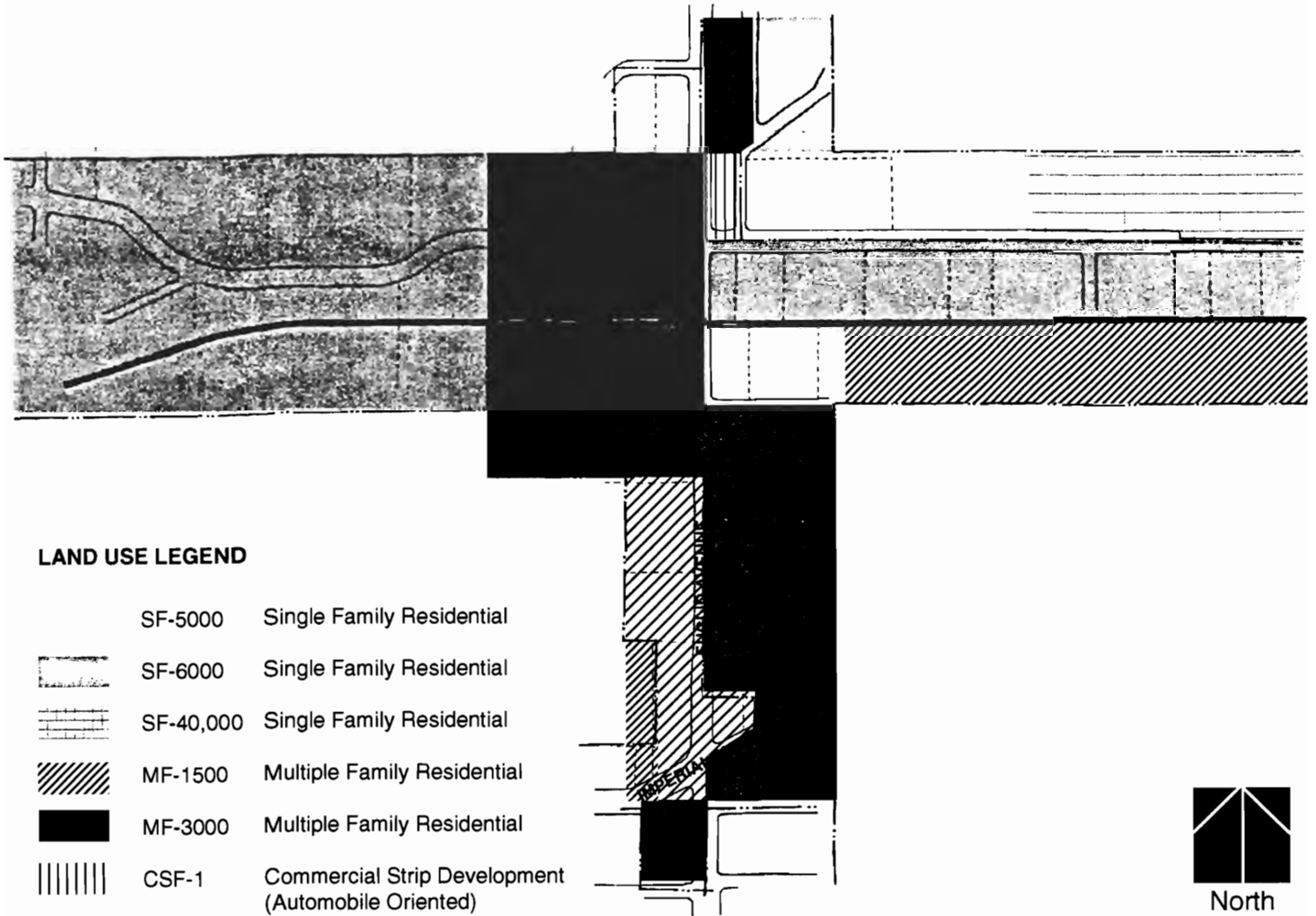





No building or improvement shall be erected, constructed, established, altered or enlarged except where designated.

Residential use is not permitted in the commercial zones except where designated.

Mixed use development of commercial and residential uses shall be permitted except in areas designated I-1 (Light Industrial) and CT-2 (Commercial Center), and OS-P (Open-Space / Park). The residential development must conform with criteria of the referenced residential zone of the planned district and with the scale and character proposed under Section 2 "Concepts".



LAND USE LEGEND

-  SF-5000 Single Family Residential
-  SF-6000 Single Family Residential
-  SF-40,000 Single Family Residential
-  MF-1500 Multiple Family Residential
-  MF-3000 Multiple Family Residential
-  CSF-1 Commercial Strip Development (Automobile Oriented)
-  CSF-2 Commercial Strip Development (Automobile Oriented)
-  CSF-3 Commercial Strip Development (Automobile Oriented)
-  CSR-3 Commercial Strip Development (Pedestrian Oriented)
-  CT-2 Commercial Center
-  I-1 Light Industrial
-  I-2 Office/Industrial Park
-  OS-P Open Space-Park

LAND USE







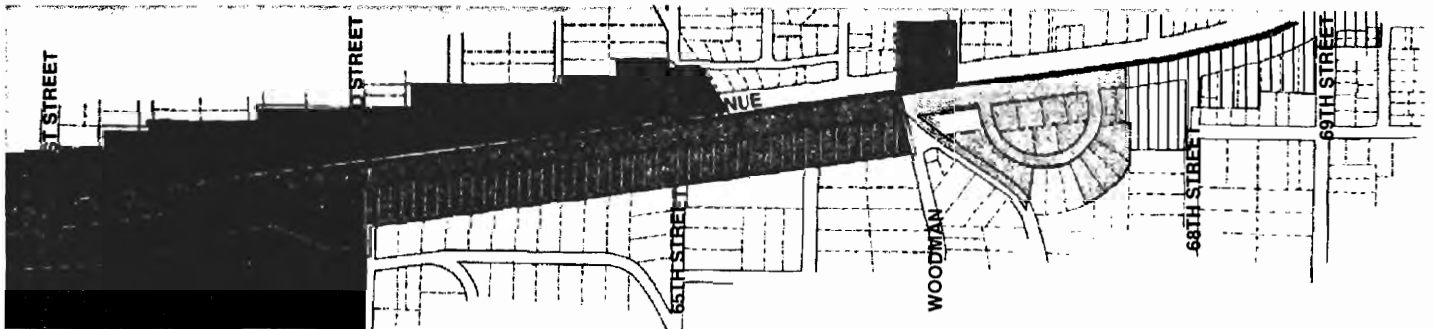





NOT TO SCALE

**EUCLID AVE. &
MARKET STREET
CORRIDORS**

3.1
FIGURE



LAND USE LEGEND

	SF-5000	Single Family Residential
	SF-6000	Single Family Residential
	SF-40,000	Single Family Residential
	MF-1500	Multiple Family Residential
	MF-3000	Multiple Family Residential
	CSF-1	Commercial Strip Development (Automobile Oriented)
	CSF-2	Commercial Strip Development (Automobile Oriented)
	CSF-3	Commercial Strip Development (Automobile Oriented)
	CSR-3	Commercial Strip Development (Pedestrian Oriented)
	CT-2	Commercial Center
	I-1	Light Industrial
	I-2	Office/Industrial Park
	OS-P	Open Space-Park



LAND USE

NOT TO SCALE

**IMPERIAL
AVENUE
CORRIDORS**

3.2
FIGURE

INTENTIONAL BLANK PAGE

3.3 Architectural Character Guidelines

3.3.1 General Objectives

- Create appropriate and consistent architectural responses to site and climate.
- Develop commercial architectural character that is consistent with the area themes and that promotes safe and attractive day and nighttime uses.
- Develop consistent and straight forward detailing that minimizes maintenance.
- Develop a consistent set of guidelines for self-help efforts that coordinate with public improvements.
- Develop a consistent approach to commercial property redevelopment.
- Use exterior materials, colors, and textures that relate to the natural environment as well as minimize the time and cost of maintenance.

3.3.2 Design Criteria & Guidelines

General

- Use building massing to develop a strong and consistent spatial definition of the street as an outdoor space.
- Recognize the importance of spaces between buildings as opportunities to develop places for outdoor activities and to create a sense of transition between indoors and outdoors. Outdoor spaces can be developed by incorporating courtyards, terraces, arcades, colonnades, and low walls, and by using vegetation as a space-defining element.

Building Scale - Euclid Commercial Corridor and Commercial Center at Euclid and Imperial

- Structures containing commercial uses will often require loading platforms. Such vehicular-scaled platforms must be screened from public view, and should not be located between the street and front of any structure. Office facilities, either free standing or related to manufacturing uses, should be designated to address the street frontage at a pedestrian scale.

Building Scale - Market Street Commercial Industrial Corridor

- Buildings along this commercial/industrial corridor should address the street frontage as a pedestrian-scaled environment. Structures containing manufacturing uses will often require loading platforms and/or large vehicular entries into the structures. Such vehicular scaled entries and platforms should be screened from public view, and should not be located between the street and front of any structure.

Building Scale - Encanto Village at Imperial Avenue

- Buildings along the Imperial Avenue corridor between 63rd and 69th Streets should be low-scale, 1 to 2-story structures, built up to the public-right-of-way property line. To increase area density, work/live development should be encouraged.

Exterior Architecture

- Building exteriors and character shall support the design concepts per area outlined in Section 2.
- Building exteriors shall promote day and nighttime commercial uses through ample exterior lighting, adequate public access, and exterior openings where possible. These openings would be glass and aluminum storefronts, windows and public-access entries along public right-of-ways.
- Exterior fixed security bars at windows and building openings, which are visible from the public right-of way, are not permitted and should be replaced with interior security screens or bars with controlled emergency release systems.

Materials & Colors - Buildings & Site Furnishings

- Colors, textures, and materials should be simple in form and able to withstand both weather and physical exposure.
- Exterior finishes should be continuously maintained and be free of excessive peeling paint, debris and graffiti.
- Exterior paint finishes shall conform to the individual area color schedules that are displayed at SEDC and the City of San Diego's Neighborhood Code Compliance Department.
- Materials that contain integral colors and texture, such as stucco, precast concrete, concrete masonry, brick, and split-faced block are encouraged. The buildings should have exterior wall materials in a variety of colors, materials and texture.

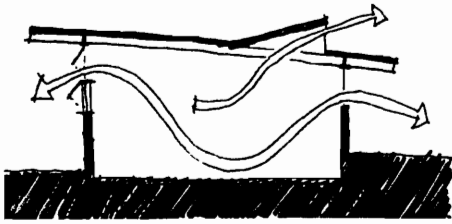

Design to maximize natural ventilation

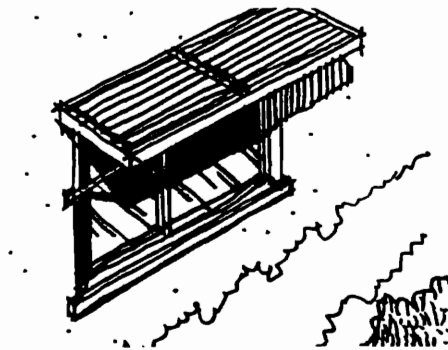

Shade screens minimize building heat gain

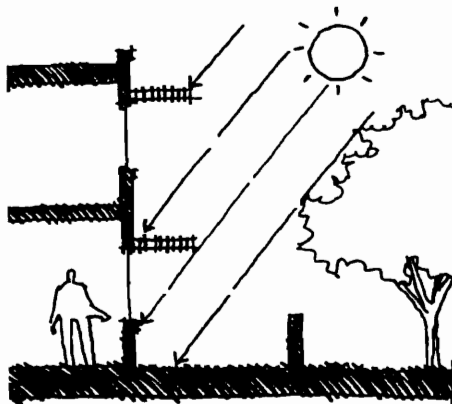

Sun screen overhangs

Climate Consideration

- Natural ventilation is preferable to mechanical systems. Use sun shading devices and recessed openings to reduce heat-gain of interior spaces. (See sketch)
- Natural ventilation should also be achieved by incorporating operable windows that allow natural airflow through interior spaces. (See sketch)
- Natural illumination is preferable to electrical systems. Use of clerestory windows, skylights, and light-fins that reflect light into interior spaces is preferable to using electrical fixtures. (See sketch)
- South-facing windows, a positive source for passive heat gain, should be placed in a manner to allow a deep penetration of sun in the winter and provide complete shade in the summer.
- Calculated overhangs should be used to allow sun into spaces in the winter and provide shade in the summer.

Building Entries

- Entries should be well defined and emphasized with accent colors, awnings, or overhead trellises.
- Entries should be human in scale, well lighted and inviting to pedestrians.
- Building entries shall conform with all City of San Diego Municipal Building Codes, the Americans with Disabilities Act (ADA), Title 24, the Uniform Building Code (UBC), and all other applicable codes and regulations.

Roof-Mounted Equipment

- No commercial signage should be mounted on any roof.
- Roof-mounted equipment should be screened or recessed within the roof structure.
- If screening is not possible, equipment should be treated as a design element. Equipment should be painted per the color schedule.

3.4 Landscaping Guidelines

3.4.1 General Objectives

Landscaping Guidelines are provided to:

- Create appropriate and consistent landscaping responses to site and climate.
- Develop commercial landscape character that is consistent with the area themes and promotes safe and attractive day and nighttime uses.
- Develop a consistent set of guidelines for self-help efforts that coordinate with public improvements.
- Develop a plant palette that creates a seamless connection to adjoining properties.
- Use exterior materials, colors, and textures that relate to the natural environment as well as minimize the time and cost of maintenance.

3.4.2 Design Criteria & Guidelines

Per the Southeastern San Diego Planned District Ordinance, prior to the use and occupancy of any premises, the property shall be landscaped in accordance with the requirements of the City-Wide Landscape Regulations contained in Chapter X, Article 1, Division 7 of the Municipal Code.

Please refer to the approved planting lists in Figures 3.3 and 3.4

Accent Trees

Accent tree plantings highlighting selected intersections and open spaces shall be incorporated to strengthen community identity, provide directional cues for visitors, and define open space for commercial use where applicable. Accent trees shall be selected from the area approved planting lists described in Figures 3.3 and 3.4.

Open Space and Recreation Areas

- Overhead utilities shall be located underground. Peripheral and under-utilized areas shall be planted with drought-tolerant shade trees, mass trees, and some large shrubs. These areas shall be irrigated by automatic drip or bubbler

systems and will be mulched with chipped prunings or commercial materials to conserve water and control weeds.

Screening

- Visual screening of utility boxes and undesirable views shall be accomplished by the use of large shrubs and small trees. See Section 3.9.2 for SDG&E utility box screening restrictions.

Prototypical Commercial Landscaping

Property and commercial business owners may select plants from the approved plant list (see Figures 3.3 through 3.4).

3.4.3 Design Guidelines

Town Center at Euclid Avenue & Market Street

Landscaping at the Market Street and Euclid Avenue Town Center shall conform to the approved plant list (see Figures 3.3 through 3.4) and be arranged to promote the intersection as the community's town center.

Euclid Avenue Commercial Corridor

Landscaping along the Euclid Avenue Commercial Corridor shall strengthen the corridor as the community's primary north-south pedestrian and vehicular commercial link. The landscape guidelines shall conform to the following criteria:

- Establish a major shaded pedestrian pathway along the west side of Euclid Avenue by incorporating a two-row, low scale linear street tree plan (see Figure 2.2).
- Provide visual enhancements as well as vehicular safety by constructing landscape street medians of enhanced-concrete paving with raised planters. Median landscaping shall consist of low-scale shrubs with street trees centered within the median's width that do not block motorist views to oncoming traffic (see Figure 2.2).

Market Street Commercial Industrial Corridor

The landscaping along the Market Street Industrial Corridor shall complement the natural open spaces that define the area as a rural enclave of the community.

- Landscaping along the street edge of Market Street shall not block views to canyon landscape, but shall complement it with

low-scale, drought tolerant, low maintenance, native planting. Site entries are the exception to this guideline and should incorporate taller landscape elements such as Palm Trees and shrubs to identify primary vehicular and pedestrian entrances.

- To create a positive sense of arrival to the Town Center and to promote the area's rural-identity to trolley users, landscape screening devices such as overhead trellis shade structures, trees, and grass berms shall be placed to enhance and screen views to the rear of industrial lots and buildings (See Figure 2.4).

Planting Concepts

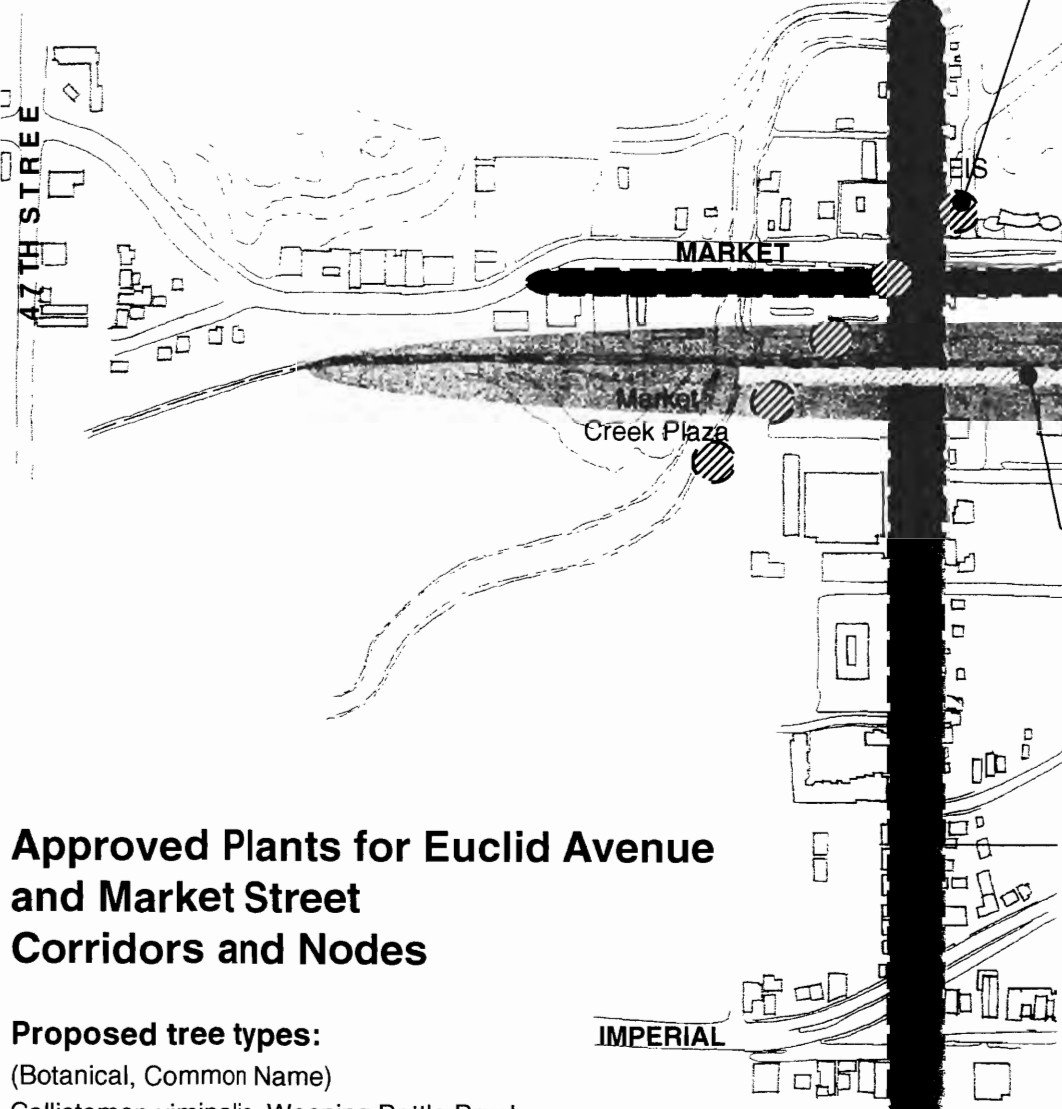

Create landscape plazas that create a visual diagonal link from the Elementary Institute of Science to the future Market Creek Plaza.

Preserve Open Space

Plant accent trees along trolley tracks to create a sense of entry to the Euclid trolley station arrival for trolley riders.

Create a "Green" linear trolley corridor with taller tree planting to announce arrival into the community.

Formal streetscape landscaping is recommended for the Euclid Avenue Corridor. Plan includes a new landscaped median and pedestrian-scaled street trees along street edge (See Euclid Avenue street section).

Approved Plants for Euclid Avenue and Market Street Corridors and Nodes

Proposed tree types:

- (Botanical, Common Name)
- Callistemon viminalis, Weeping Bottle Brush
- Eucalyptus ficifolia, Red Flowering Gum
- Eriobotrya deflexa, Bronze Loquat
- Geijera parviflora, Australian Willow
- Golden Rain Tree
- Gold Medallion Tree
- Jacaranda mimosifolia, Jacaranda
- Koelreuteria bipinnata, Chinese Flame Tree
- Pinus canariensis, Canary Island Pine
- Platanus acerifolia, London Plane Tree
- Podocarpus Gracilior, Fern Pine
- Purple Leaf Flowering Tree
- Queen Palm
- Quercus agrifolia, Live Oak
- Washington robusta, Mexican Fan Palm

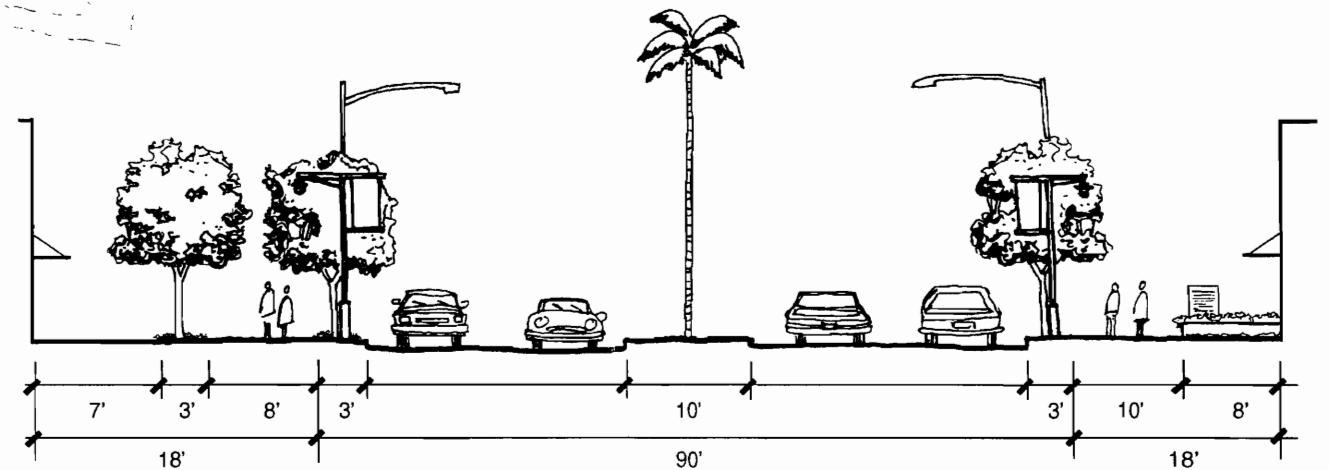

Euclid Avenue Street Section

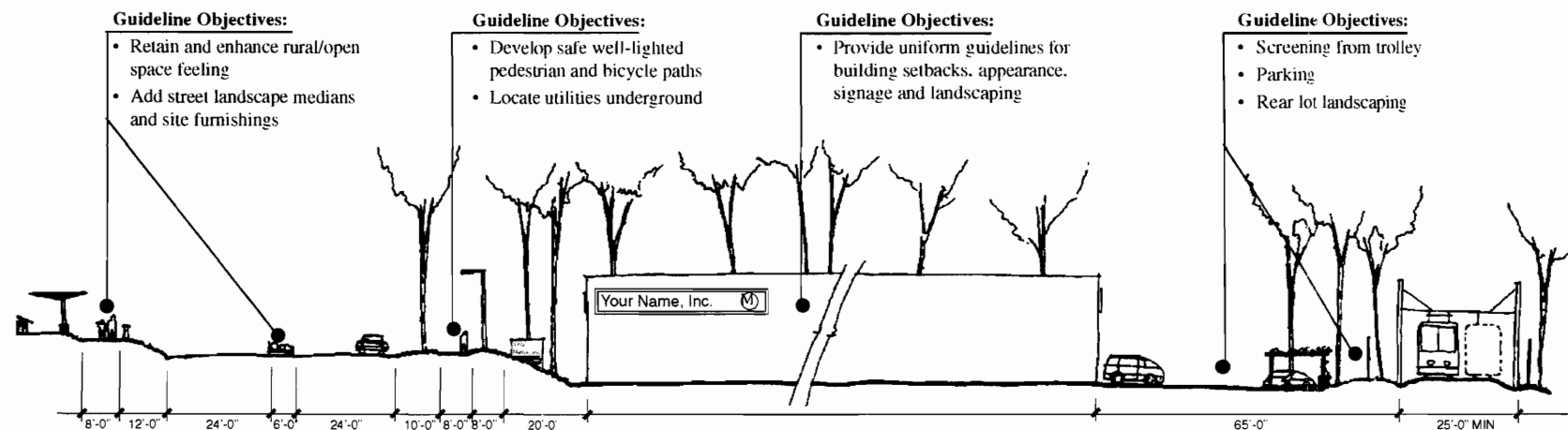

Market Street Partial Street Section

Guideline Objectives:

- Retain and enhance rural/open space feeling
- Add street landscape medians and site furnishings

Guideline Objectives:

- Develop safe well-lighted pedestrian and bicycle paths
- Locate utilities underground

Guideline Objectives:

- Provide uniform guidelines for building setbacks, appearance, signage and landscaping

Guideline Objectives:

- Screening from trolley
- Parking
- Rear lot landscaping

NEIGHBORHOOD PLANTING PLAN

NOT TO SCALE

3.3
FIGURE

EMERALD HILLS

Planting Concepts

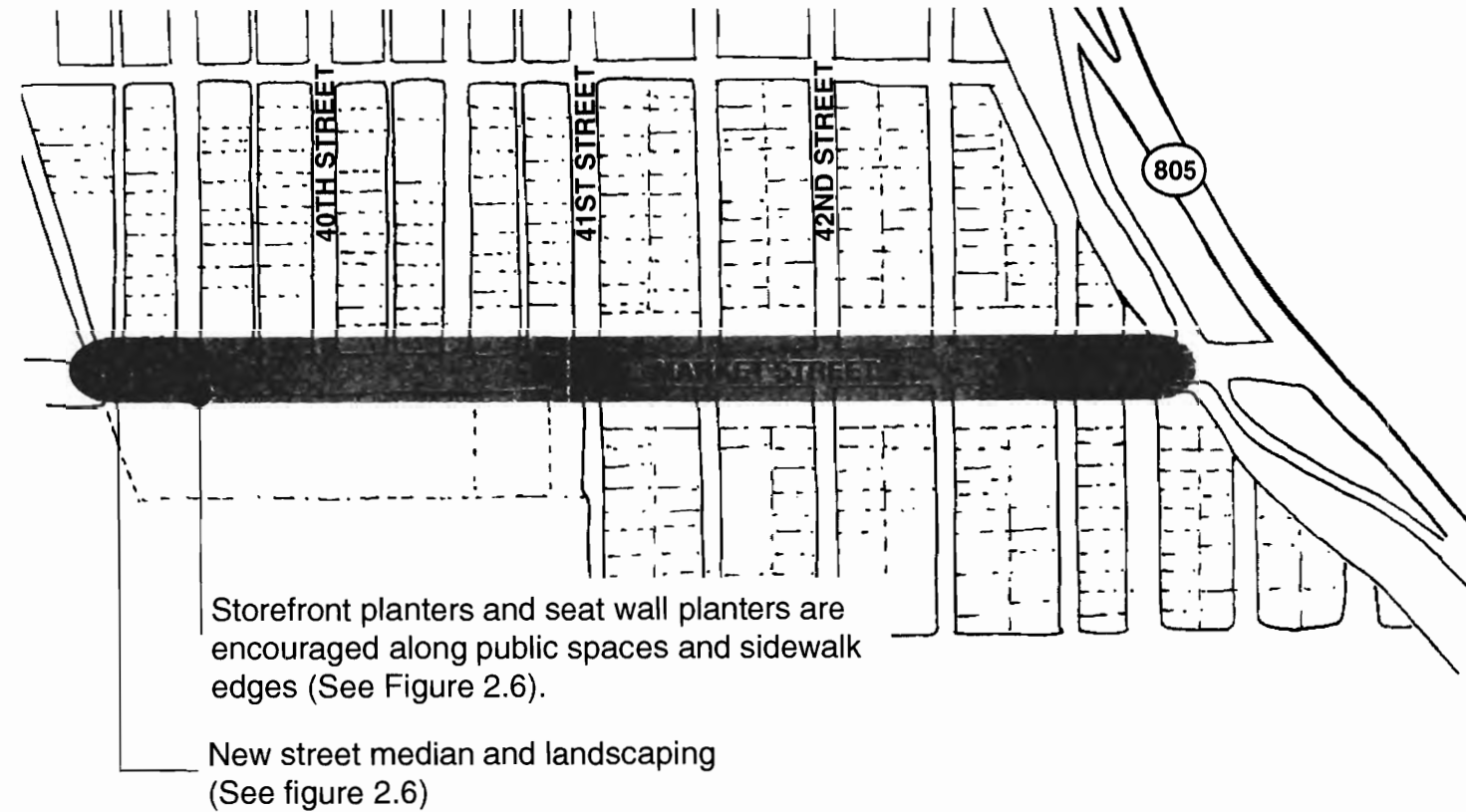

Approved Plants for Mount Hope Commercial Corridor

Tree Types:

(Botanical, Common Name)

- Gold Medallion Tree
- Koelreuteria bipinnata, Chinese Flame Tree
- Mediterranean Fan Palm
- Pinus canariensis, Canary Island Pine
- Podocarpus gracilior, Fern Pine
- Swan Hill, Fruitless Olive
- Tabebuia impetiginosa, Pink Trumpet Tree

Approved Plants for Encanto Village

Tree Types:

(Botanical, Common Name)

- Brahea armata, Mexican Blue Palm
- Eucalyptus ficifolia, Red Flowering Gum
- Geijera parviflora, Australian Willow
- Gold Medallion Tree
- Jacaranda mimosifolia, Jacaranda
- Koelreuteria bipinnata, Chinese Flame Tree
- Quercus agrifolia, Live Oak
- Raywood Ash
- Tipuana tipu, Tipu Tree
- Washington robusta, Mexican Fan Palm

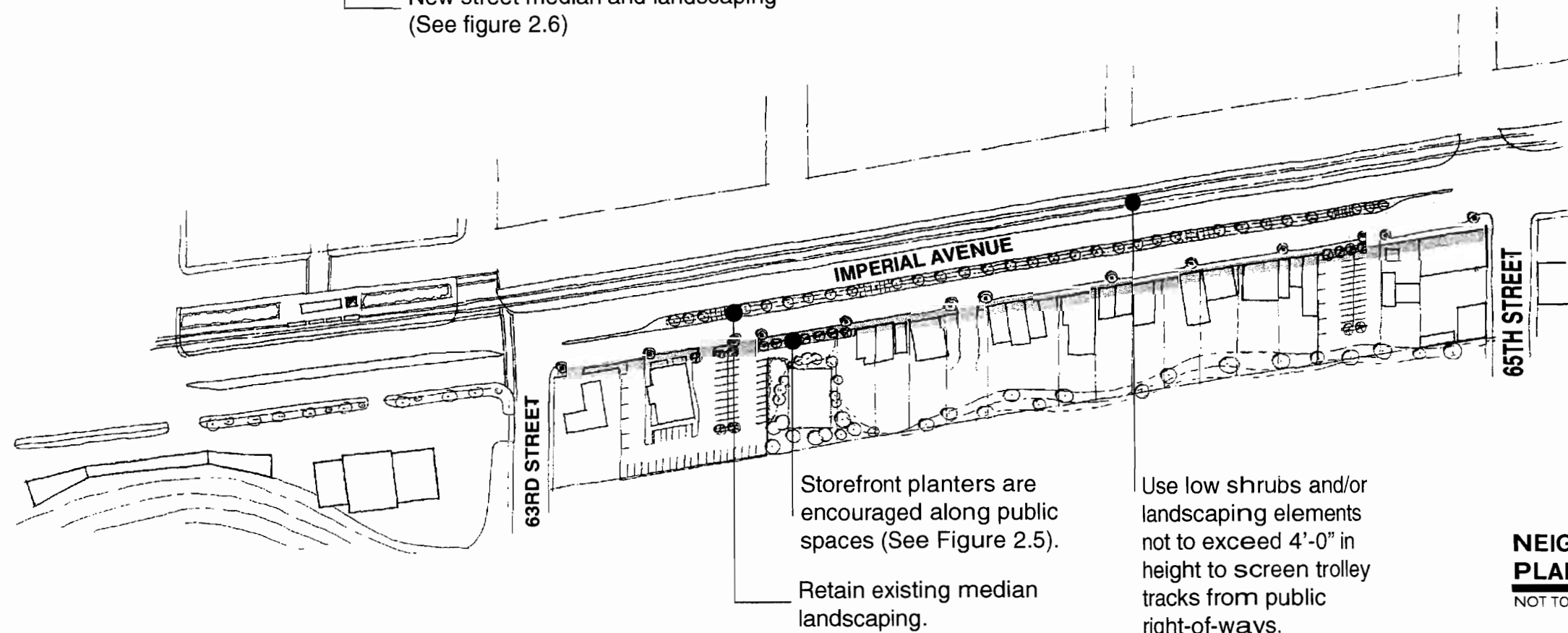

NEIGHBORHOOD PLANTING PLAN

NOT TO SCALE

3.4
FIGURE

MOUNT HOPE AND ENCANTO

3.5 Circulation and Parking Guidelines

3.5.1 Guideline Objectives

- Accommodate primary and secondary vehicles.
- Increase safety and use of parking lots.
- Visually enhance the property and adjacent uses.
- Conform to high design standards found in major commercial developments.
- Reinforce setback edges where parking lots are open to streets.
- Increase the safety of the pedestrians from street traffic by separating the pedestrian and traffic zones with a combination of parkways, street trees, lamps and on-street parking zones.
- Develop off-street parking areas for vehicles that cannot be accommodated on driveways and allow only short-term visitor parking on the street.

3.5.2 Design Criteria & Guidelines

Street Character and Vehicular Circulation

- Design site access points and develop efficient circulation systems that minimize the impact to available open space.
- Establish a circulation system that minimizes pedestrian and vehicular conflicts. Where feasible, separate pedestrian walkways from roadways and service areas.
- All public-right-of-way sidewalks and pedestrian paths shall be concrete construction and shall meet ADA and UBC standards. Bicycle paths shall be integral with streets and shall be delineated by paint striping, painted bicycle path logos, and bicycle lane signage.

Street Crossings

Special enhanced street crossings are required at the intersections of Market Street and Euclid Avenue, and Euclid Avenue and Imperial Avenue. At these crossings, primary pedestrian routes cross primary vehicular routes and should be enhanced to highlight the crosswalks for motorists as well as identify the commercial and cultural centers of the community.



ADA compliant pedestrian ramps

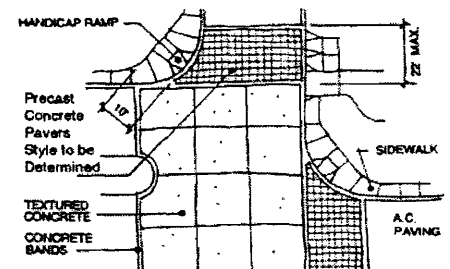

Enhanced paving and crosswalks at major intersections

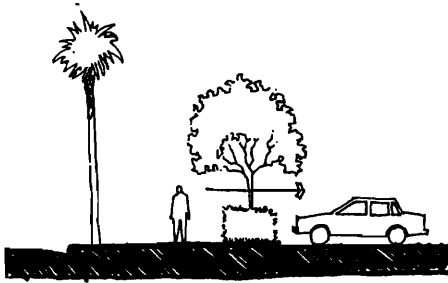

Low walls or shrub landscaping strengthens urban edges along parking lots while maintaining views from sidewalks.

- Crosswalks at these intersections shall be constructed of specialty paving surrounded by concrete bands. Crosswalks at other locations shall not be highlighted. (See sketch)

Parking Areas

All parking areas will be maintained in a weed-free and debris-free condition and will be subject to the following criteria:

- Parking areas shall comply with all applicable current City of San Diego, State of California, and Federal codes.
- All parking lot landscape plantings shall be maintained per the Criteria Guidelines listed in the Property Maintenance found in the next section of this document.
- Increase safety and use of parking lots by adding lighting, landscaping, and pedestrian paths inside the lots where possible (See sketch and Lighting Regulatory Guidelines under Section 3.9).
- All individual parking stalls shall be striped per code and shall incorporate wheel stops (See sketch for dimensions).
- Where possible, designate parking with 90-degree stalls and aisles wide enough for two-way traffic (See sketch on opposite page).
- All parking lots shall be continuously maintained or repaired.
- To provide direct sunlight relief and to reduce glare, provide landscaping throughout parking lots with trees and low shrubs.
- Where bollards are required to protect buildings from vehicular damage, make bollards impact resistant, and night lighted or reflective.
- Make repairs to existing paving, curbs and gutters to conform to the standards of new construction.
- Provide handicapped stalls to meet the State of California and Federal requirements.
- All handicapped parking stalls shall be striped per State and Federal access codes and shall incorporate wheel stops (See sketch for dimensions).

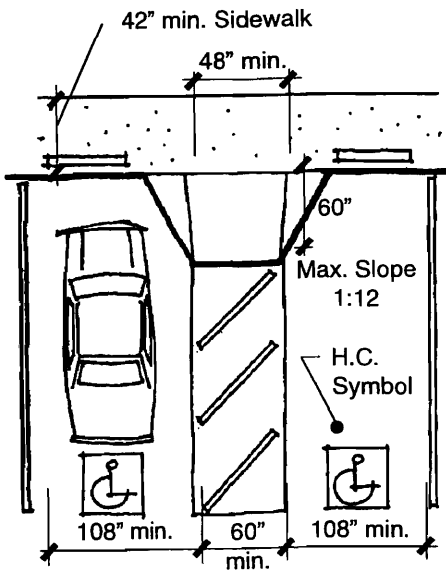

Handicapped parking stall configuration and dimensions

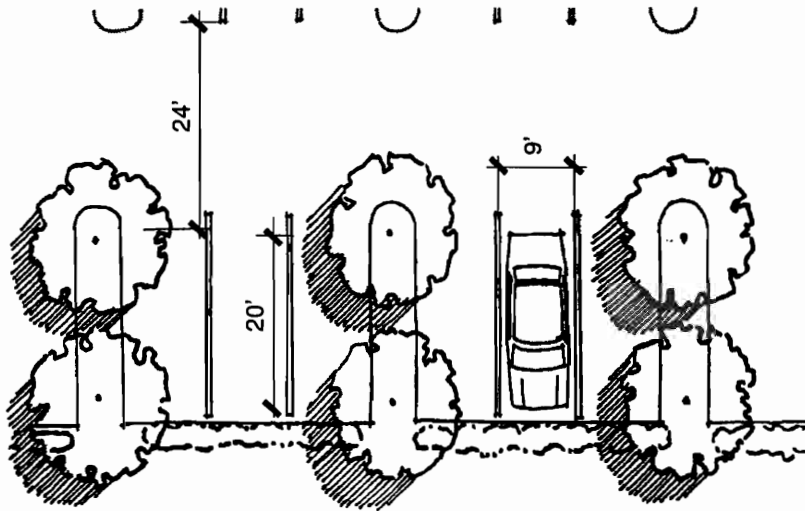

Standard 90 degree parking lot configuration and dimensions

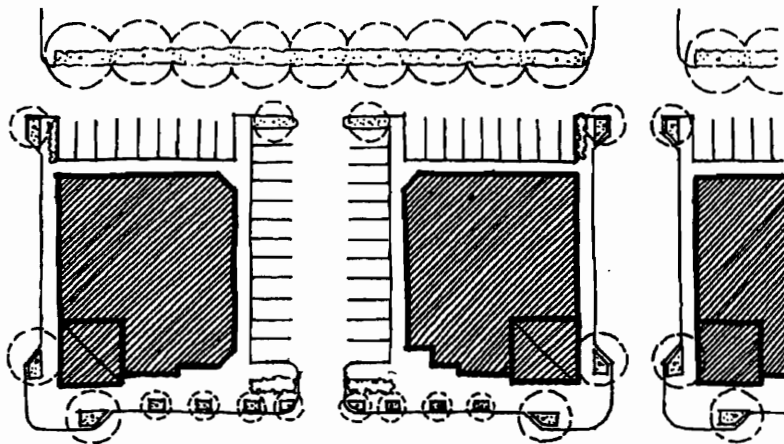

Parking along sides and rear of buildings maintains urban edges

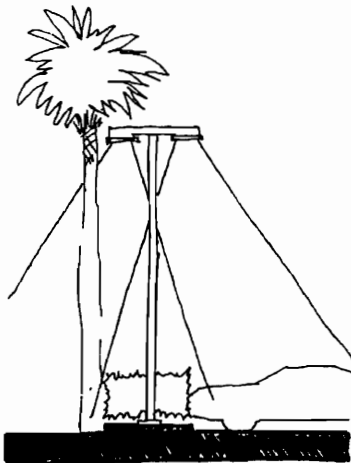

Street and parking lot lighting

3.6 Property Maintenance

3.6.1 General Objectives

Routine building and landscape maintenance of individual lots will be the responsibility of each property owner and shall conform to the criteria guidelines listed below.

If a property owner fails to maintain privately-owned buildings and landscaping in a satisfactory manner, the City of San Diego's Neighborhood Code Compliance Department will notify the owner by site visit and/or certified mail of the conditions requiring correction. Property owners shall be given a reasonable amount of time, determined by the Department, to correct any maintenance deficiencies, unless an agreement to extend the period, for such cause as fire or other disaster, is made by the property owner.

3.6.2 Design Criteria & Guidelines

Landscape Maintenance

All planted areas will be maintained in a weed-free and debris-free condition and will be subject to the following criteria:

- Lawn and ground cover areas will be kept trimmed and/or mowed regularly.
- All plantings will be maintained in a healthy and growing condition by regular watering, fertilization, cultivation, and pruning.
- Damaged or diseased plants will be replaced or repaired within (30) thirty days of notification by the City.
- Irrigation systems will be maintained in proper working condition and checked, cleaned, and adjusted regularly.
- Pruning will be done regularly, at the appropriate times of the year, in order to promote trunk caliper, desired form and health of plants and to prevent excessive wind damage.
- Tree stakes, guys, and ties will be checked and adjusted regularly to avoid trunk girdling and abrasions.
- All unplanted landscape improvements, i.e. benches, planter walls, etc., shall be continuously maintained, repaired or replaced.

- Vehicles parked on landscaping are a citable offense.
- Removal of required landscaping is a citable offense.

Site Maintenance - Fences, Gates and Walls

Walls, fences and gates shall be maintained and shall be free of deterioration in a weed-free and debris-free condition. Walls, fences and gates will be subject to the following criteria:

- All fence and wall materials are subject to approval. As a guideline, all materials should be chosen to be architecturally compatible with the building's exterior. Barbed wire fencing and chain-link fencing are not permitted in any area visible from the public right-of-way.
- Retaining walls over 2 feet in height with a slope backfill or 3 feet high with level backfill and fence exceeding 6 feet in height requires a building permit (Development Services Department).
- Low walls and fencing are allowed and encouraged along the commercial property lines to establish and strengthen an urban edge along commercial retail corridors. Low walls and fencing if applied, shall provided public access and shall not block visual access to buildings beyond.

Building Maintenance

Building conditions and appearance shall be maintained in good condition and will be subject to the following criteria:

- All building additions, improvements, and independent structures shall have a valid building permit for construction issued by the City of San Diego Building Department. Structures or additions without a permit shall not be occupied until a valid permit is issued and inspected by a City of San Diego Building Inspector.
- Exterior building elevations shall be clean and free of graffiti.
- Exterior building damage shall be repaired within (3) three months from notification by the City.
- Structurally damaged buildings shall be repaired within a reasonable amount of time of notification by the City.
- Building signage, including addresses, shall be clear from visual obstructions and debris (See Signage Regulatory Guidelines).

- All exterior building lighting fixtures shall be maintained in proper working order to illuminate a safe, significant portion of the pedestrian entry access and building address. Building lighting is recommended to prevent any “dark” recesses along the public-right-of-way (See Section 3.9 Lighting and Utilities).

Trash

- Trash containers, dumpsters, bins and enclosures shall be located away from public view where feasible. Where trash containers, dumpsters, bins and enclosures are visible from or near the public right-of-way, they shall be screened by a solid wall, fence or landscaped element with a minimum height of one (1) foot higher than any container to be screened.
- Trash receptacles at private property shall not be visible from the public-right-of-way except on days of collection.
- Trash receptacles are required at all significant public open space and recreation areas.
- Trash receptacles in public spaces shall be manufactured precast concrete with integral color and sandblasted finish to match neighborhood wall and signage treatment.
- Receptacles in public spaces shall conform to the City of San Diego’s *Consultants Guide to Park Design, Rights-of-Way and Open Space Landscaping*.

Graffiti

SEDC currently has a zero-tolerance policy against graffiti applications throughout Southeastern San Diego. The policy enforces same-day removal of graffiti on both public right-of-way locations and private property.

- Per the SEDC zero-tolerance policy, graffiti shall be removed through the use of anti-graffiti applications or by reapplying the existing exterior finish over the graffiti. Reapplications of paint color must match the existing building color.

Outdoor Storage

- No material, equipment, supplies, or products shall be stored or permitted to remain on the property outside a permanent structure.
- Outdoor storage of merchandise, material or equipment shall be subject to all municipal codes and planned district ordinances. This provides that:

- The storage area shall be completely screened or enclosed by solid fences, walls or buildings not less than six (6) feet tall.
- There shall be no outdoor storage of merchandise, materials, equipment or other goods of a height greater than that of any enclosed wall, or buildings.
- Outdoor storage shall not be placed on any public right-of way.

Inoperable Vehicles

- A maximum of two inoperable vehicles may be stored on private property if they are fully, legally screened from the public right-of-way in an area not exceeding 400 square feet.

3.7 Commercial Signage

4.3.1 General Objectives

The signage program for the commercial redevelopment area has been designed to:

- Provide appropriate and consistent signage for identity, orientation, and safety.
- Enhance the overall community visual environmental theme.
- Clearly communicate required directional information.
- Provide durable and low-maintenance construction.
- Coordinate with the design of the adjacent architecture.
- Meet the requirements of all applicable City of San Diego signage regulations.

3.7.2 Design Criteria & Guidelines

General Guidelines

- Commercial signage shall comply with the criteria contained within the city-wide sign regulations, Chapter X, Article 1, Division 11 of the Municipal Code.
- Commercial signage shall consist of two types: 1) building facade signage viewable from the public right-of-way and; 2) low-scale pedestrian-oriented signage that supports each area's overall pedestrian and automobile concept theme. One sign per type is allowed at each individual business. Any commercial signage, both permanent and temporary that exceeds this allowance without City/SEDC consent shall be deemed excessive and shall be removed by the business or property owner within (3) working days of the notice.
- All signs, including temporary signs, require a permit and must be approved by SEDC prior to installation. Approval of temporary signs shall include the period of time for which they will be permitted. Unless otherwise approved by SEDC, only one building-mounted sign and one ground-mounted sign identifying the occupant, nature of business and or products or services shall be permitted for each occupant. (See *Other Signs* for exceptions). The only other allowed signs will be directional signs or temporary signs.

- Banners, pennants, flags are only permitted for a grand opening of a new business (maximum 60 days).
- A-Frame signs are not permitted.
- All building signage, including property addresses, shall be visible from the public right-of-way and shall be clear from visual obstructions and debris.
- All signs must be either attached to the building or ground-mounted and adhere to all San Diego Municipal Code, Division 11 regulations for on-premise signs plus the following guidelines:

Building-Mounted Signs

- Shall be installed so as to be parallel to and contiguous with building walls in a manner proportionate to the wall on which they are mounted.
- Letters, symbols, or logos may be painted or integrally colored.
- Letters, symbols, or logos should be securely fastened to the buildings no less than one and one half inches from the building face to provide for sufficient drainage and to prevent staining of the building face, but no further than 6 inches from the building face.
- A maximum 3 foot square logo may be incorporated with the building-mounted sign.

Commercial Center Signs

- Signage within a shopping center shall be coordinated throughout the commercial development. A comprehensive sign program detailing types, sizes, locations and quantities shall be submitted for approval.

Ground Mounted Signs on Industrial Lots along Market Street

- Shall not be closer than 10 feet from any property line and shall not be located within the street right-of-way.
- Shall not be closer than 3 feet from a driveway or parking area.
- Shall not exceed 4 feet in height from the ground surface on which it is mounted.
- Shall be a precast concrete sign with an anti-graffiti application applied to the surface.

Specific Area Signs

Market Street Commercial Industrial Corridor from 47th Street to 54th Street

For the industrial buildings within the Market Street Commercial Industrial Corridor from 47th Street to 54th Street, a secondary building-mounted sign is allowed and encouraged to be placed on the rear building facade - viewable from the trolley corridor. The same regulatory criteria listed above shall apply to the size and location dimensions. The signage shall not exceed the size of the original signage mounted on the front building facade.

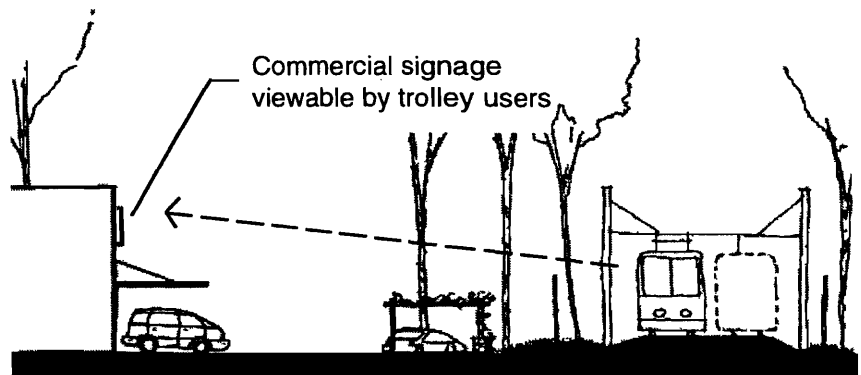

Building signage and view corridors in back of industrial lots along trolley line

Encanto Village at Imperial Avenue between 61st to 69th Streets

For the commercial buildings within the Encanto Village at Imperial Avenue between 61st and 69th Streets a secondary “pedestrian-oriented” building-mounted sign is allowed and the following regulations shall apply:

- Signage shall be installed so as to be parallel to and contiguous with the building wall in a manner proportionate to the wall on which it is mounted (see sketch).
- Signage shall consist of matte finish metal or wood base with painted letters, symbols or logos on the surface.
- Letters, symbols or logos may be painted or integrally colored.
- All letters shall be a minimum of 3 inches in height.
- All letter, symbol or logo color schemes will be subject to approval.

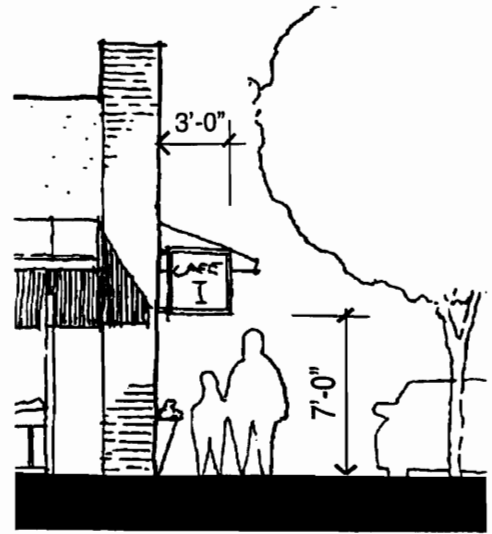

Pedestrian-oriented signage along Encanto Village street-front buildings

The only other allowed signs will be directional signs or temporary signs meeting the following guidelines:

- **Internal Directional Signs:** Directional signs indicating loading or delivery areas, employment office, various building entries, and parking lot signs shall not exceed 378 square inches nor employ lettering larger than 8 inches in height.
- **Temporary Signs:** During the construction phase of the project, one construction or leasing sign with the minimum dimensions of 8 feet by 12 feet mounted on two six inch by six inch posts will be permitted. If a sign is to be supported by unfinished posts, the base of the sign shall be framed out to give a finished appearance.
- No temporary sign is to be constructed more than four feet above ground level, as measured to the base of the sign, unless otherwise approved. The sign shall be removed upon ninety percent occupancy of the building. After the construction phase of a project and ninety percent occupancy of the building, the only temporary sign permitted would be one indicating “For Sale” or “For Lease”, provided that there is space available in that particular building.

3.8 Site Furnishings

3.8.1 General Objectives

One of the goals of the Commercial Corridor Urban Design Guide is to create a uniform appearance along the commercial corridors and nodes as well as provide a comfortable and inviting environment for business patrons and staff. Site furnishings are amenities and features that make the commercial zones more pleasant, safe, and comfortable. There is a need for a consistent site furnishing program to help foster a unified community appearance. All of the site furnishings should be coordinated in the use of materials and colors.

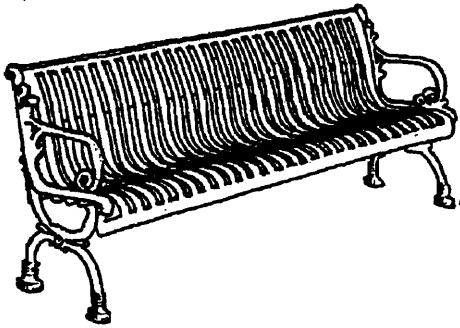

Metal bench at public spaces

3.8.2 Design Criteria & Guidelines

Site furnishings at the public right-of-way commercial zones and open space shall be:

- Consistent with and enhance the overall visual environmental theme.
- Compatible with commercial architecture.
- Durable, vandal-proof and low-maintenance.
- In compliance with the requirements of all applicable standards.

Benches

There are few existing benches found in public spaces within the redevelopment district. Benches give a sense of comfort to public areas and open spaces within the community and create an opportunity to continue a design theme of streetscape elements.

- Benches will be located at open space and commercial areas.
- Benches for high-visibility areas shall consist of durable rolled-metal park benches painted black with seating clearances of no more than 5'-0" wide. (See sketch).

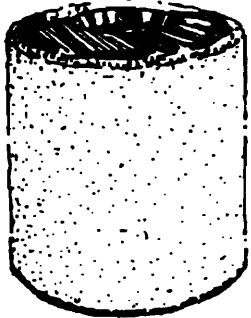

Public space trash receptacles

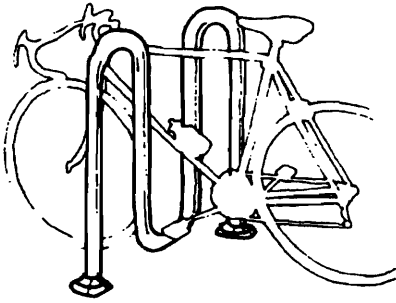

Recommended bicycle rack

Bicycle Racks

Bicycle use should be encouraged within the community to help reach energy efficiency goals in addition to being used for recreational use. It is important to provide convenient bicycle storage (e.g. bicycle racks) at all significant commercial businesses and open space areas.

- Bicycle racks should be simple yet vandal-proof racks that are durable and require no maintenance. See sketch on this page for a recommended bicycle rack selection.

Drinking Fountains

The need for drinking fountains is limited to community open space zones, recreation areas, and at major commercial centers.

- Drinking fountains shall be located on hard services and meet ADA accessibility requirements.
- Drinking fountains shall be supplied with a potable water line and nearby control valves and overflow drain inlets.
- All drinking fountains shall comply with applicable sections of the Uniform Plumbing Code and State and Federal access regulations.
- Drinking fountains in high visibility areas shall be the wall-mounted type and or pedestal-mounted fixtures matching neighborhood visual themes.

Trash Receptacles

See Section 3.6.2, Property Maintenance for trash enclosures and receptacles.

- Trash receptacles in public spaces shall be manufactured precast concrete with integral color and sandblasted finish to match neighborhood wall and signage treatment.
- Receptacles in public spaces shall conform to the City of San Diego's *Consultants Guide to Park Design, Rights-of-Way and Open Space Landscaping*.

INTENTIONAL BLANK PAGE

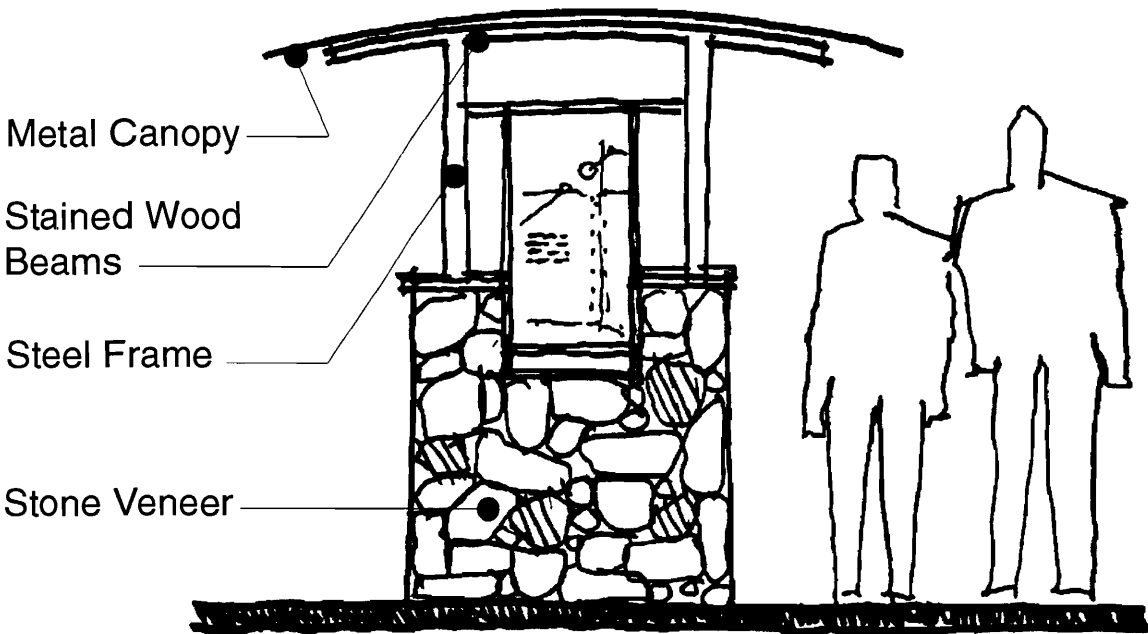

Directional Kiosk

Option 1



Stone Surface



Wood Stain



Color 1



Polished Aluminum Canopy

Option 2



Stone Surface



Wood Stain

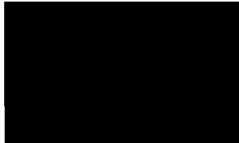

Color 1



Galvanized Metal Canopy

SITE FURNISHINGS: DIRECTIONAL KIOSKS

NOT TO SCALE

3.6
FIGURE

COLOR SCHEDULE

INTENTIONAL BLANK PAGE

3.9 Lighting and Utilities

3.9.1 General Objectives

The general objective of the Lighting and Utilities Regulatory Guidelines is to provide safe, attractive and design-consistent commercial environments.

3.9.2 Design Criteria & Guidelines

Public Right-of-Way Lighting

Lighting shall adhere to the following criteria:

- The major arterial roads shall be illuminated with new light standards, as indicated in sketches in this section. These standards shall be 30 feet high with high pressure sodium lamps and shall have anodized aluminum poles and lamp housings. These new fixtures shall be placed at a maximum interval of 200 feet.
- Pedestrian-oriented street lights shall be 20 feet high with a spacing interval of approximately 150 to 200 feet. Intersections and street corners shall be separately illuminated, with special attention paid to the illumination level for pedestrians. The exact layout of this lighting will be determined in the detailed design phase.
- Lighting for pedestrian paths and walkways along natural paths and open space areas shall be precast concrete fixtures with anodized aluminum housings. These fixtures shall be 24 inches above grade, spaced 25 to 30 feet horizontally.
- The use of energy-conserving fixtures or lighting systems should be given the highest priority.

Commercial Property Lighting

Lighting on private property shall adhere to the following criteria:

- All exterior building lighting fixtures shall be maintained in proper working order and illuminate a safe, significant portion of the pedestrian entry access and building address. Building lighting is recommended to prevent any “dark” recesses along the public-right-of-way.

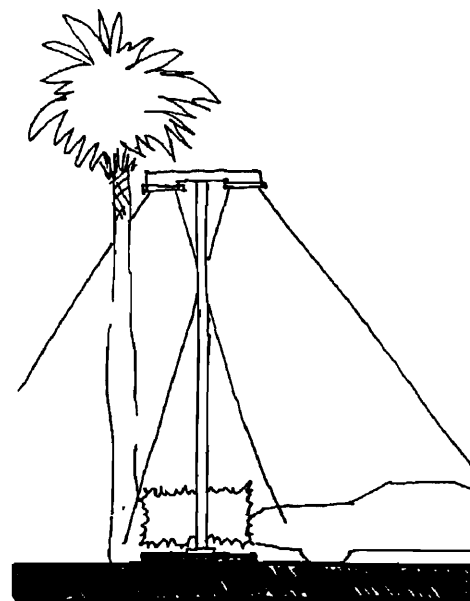

Street and parking lot lighting

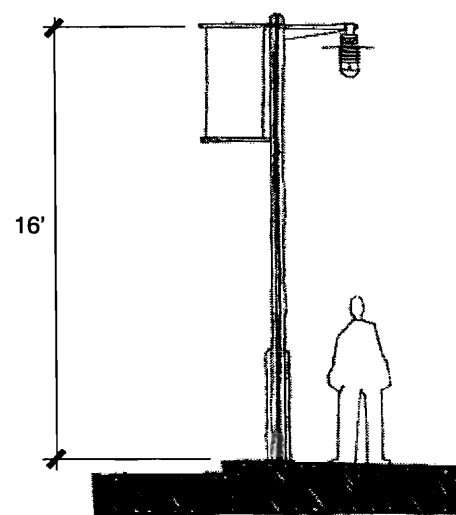

Pedestrian-scaled street lamps with commercial theme banners

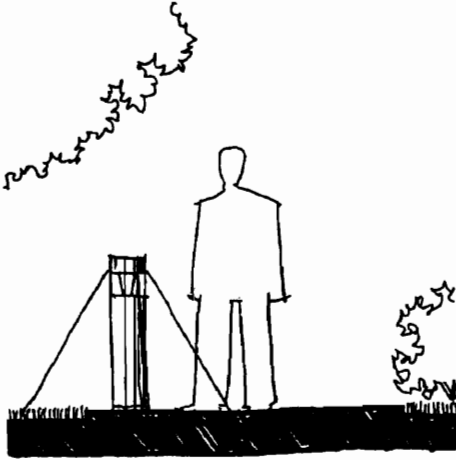

Bollard lighting along pedestrian paths

- The use of energy-conserving fixtures or lighting systems should be considered.
- All site, landscape or building lighting shall be of a configuration, style and finish color that complements the architectural theme and materials established by the building architecture.
- All sign lighting shall comply with the City of San Diego Municipal Code, Division 11. Sign lighting and fixtures shall be compatible in design and finish with the architectural theme established by the buildings.

Bollards

The use of lighted bollards at key pedestrian locations along streets and at public open spaces help slow traffic down and create safer pedestrian zones. Bollards can also close off service drives for maintenance, making them removable for authorized personnel only.

Power, Telephone, and Cable Television Lines

A phasing program for the underground installation of power and communication lines should be implemented. These utilities shall be located in concrete-encased underground duct banks, with manholes for access. Pad-mounted transformers would replace existing pole-mounted transformers. The pad-mounted transformers would be located for easy access and screened from view by landscape elements. Bollards shall be used to protect installations from vehicular traffic.

Utility Boxes

To visually enhance commercial property, utility boxes can be screened with low walls, landscaping and repainting. All site improvements must conform to San Diego Gas and Electric Guidelines and it is advisable to contact a SDG&E representative for design assistance. See Table 3.1 on the following page for required clearances for SDG&E utility boxes.

Table 3.1

Required clearances for SDG&E utility boxes.

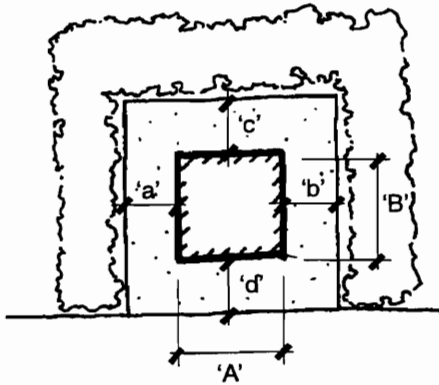

Applicable dimensions diagram for utility box screening (See Table 3.1)

Pad Usage	Const. Std.	Pad or Structure Dimension and Minimum Operating Width		Minimum Clearance Dimensions			
		'A'	'B'	'a'	'b'	'c'	'd'
3 Capacitor	3414	64"	60"	48"	96"	18"	18"
3 Phase Service Restorer (preferred)	3415	60"	64"	18"	18"	18"	96"
3 Phase Service Restorer (alternate)	3415	64"	60"	18"	96"	18"	4"
3 Phase Cable Terminating Cabinet (200 AMP)	3416	80"	30"	18"	18"	18"	96"
3 Phase Cable Terminating Cabinet (600 AMP)	3417	48"	48"	96"	96"	18"	18"
1 Phase Cable Terminator (Future Transformer Installations)	3421	46"	48"	4"	4"	12"	96"
3 Phase Fused Switching Cabinet	3421	46"	48"	96"	96"	4"	4"
1 Phase Fused Sectionalizing Cabinet	3421	48"	46"	96"	96"	4"	4"
1 Phase Cable Terminator	3421	48"	46"	18"	18"	18"	96"
1 Phase Transformer (25-167 KVA)	3421	46"	48"	18"	18"	18"	96"
3 Phase PME 3 Switch (600 AMP)	3422	78"	59"	96"	96"	18"	52"
3 Phase PME 9 Switch (600 AMP)	3423	73"	78"	96"	96"	52"	52"
3 Phase PME 10 Switch (600 AMP)	3423	73"	78"	96"	96"	52"	52"
3 Phase PME 11 Switch (600 AMP)	3423	73"	78"	96"	96"	52"	52"
3 Phase Automatic Transfer Switch (600AMP S & C)	3423	73"	78"	96"	96"	12"	72"
3 Phase Transformer	3425	78"	59"	18"	18"	24"	96"
3 Phase Transformer	3426	78"	75"	18"	18"	24"	96"
3 Phase Livefront Transformer	3427	98"	92"	18"	18"	24"	96"



Section 4 Resource Guide

4.0 Introduction

The *Resource Guide* provides assistance to property and business owners in the Commercial Redevelopment District by highlighting the roles of redevelopment organizations. Organizations presented are available to complement this guide in answering questions about commercial property redevelopment or improvements.

The organizations listed below include Southeastern Economic Development Corporation, 4th District Council Office of George Stevens, Diamond Business Improvement District, Central Imperial Project Area Committee, City of San Diego Planning and Development Review, City of San Diego Neighborhood Code Compliance, City of San Diego Storefront Improvement Program, San Diego Police Department Community Relations Division, Jacobs Foundation which includes the Market Creek Plaza Development, San Diego Gas & Electric and Metropolitan Transit Development Board.

A list summarizing agency contacts, addresses and phone/fax numbers is provided at the end of this section.

4.1 Southeastern Economic Development Corporation

The Southeastern Economic Development Corporation (SEDC) is an independent corporation in charge of all redevelopment activities within a 7-square-mile area adjacent to downtown San Diego.

Established in 1981, SEDC is responsible for an area bound by Highway 94 to the north, Interstate 5 to the south and west, and 69th Street to the east. SEDC's sphere of influence covers 15 neighborhoods and four redevelopment project areas -- Central Imperial, Gateway Center West, Mount Hope and Southcrest.

SEDC has developed a corporate strategy based upon the twin pillars of redevelopment and business development. As a result, it is dedicated to updating the infrastructure throughout its entire geographic sphere of responsibility. At the same time, its commitment to encourage and actively assist both new and existing enterprises is clear and unequivocal.

SEDC objectives include:

- Increase the number of adequate retail facilities that offer quality merchandise.
- Provide sites for new and relocated industries that will provide jobs for Southeastern San Diego residents.
- Maximize the multiplier effect that economic growth, new jobs and the improved environmental aspects of a specific project will have on the entire southeastern community.
- Promote affordable housing opportunities.
- Promote local entrepreneurship by providing incentives for industrial/commercial development by local residents.
- Eliminate blighting influences such as incompatible land uses, obsolete and substandard structures, and underutilized land.

4.2 4th District Council Office of George Stevens

The 4th District Council Office of George Stevens assists the community of the 4th District in reaching positive social, economic, environmental and education goals. Through empowerment and fostering leadership, part of the mission of the Council office is to:

- Act as a role model for restoring neighborhoods as the basic foundation of government.
- Secure community development and enhancement in the Fourth District's infrastructure.
- Provide a positive environment for restoring and maintaining the family.
- Create a sense of empowerment and community pride through economic growth and development, which has made the 4th District Council a great place to live, work, and do business.

4.3 Diamond Business Improvement District

The Diamond Business Improvement District is a California public benefit corporation which strives to:

- Bring about the revitalization of the Diamond area and its surroundings.
- Bring about the investment of private and public capital within the Diamond and its surroundings for public benefit and charitable purposes.
- Bring about increased provision of quality public improvements and educational, cultural, artistic, charitable, and social services.
- Increase the economic well-being of residents, employees, and business.
- Promote business improvement which includes, but is not limited to, those activities set out in the California Parking and Business Improvement Law and its successors: general promotion of business activities; the acquisition, construction or maintenance of parking; decoration of any public places in the area; furnishing of music in any public place in the area.
- Increase the quality of housing, enhance neighborhood character and ownership opportunities.

4.4 Central Imperial Project Area Committee (PAC)

The Central Imperial Project Area Committee (PAC) is an advisory group to the Redevelopment Agency of the City of San Diego and the Southeastern Economic Development Corporation Board of Directors. The PAC reviews and evaluates plans, programs, and policies which affect the lives of those who live, work and own property or businesses in the Central Imperial Project Area. The PAC is made up of property owners, business owners, residents, tenants, and representatives of community organizations.

4.5 City of San Diego Planning and Development Review

The City of San Diego Planning and Development Review Department assists business and property owners with building and site modifications, new construction, planning, and redevelopment questions. The department reviews and approves planning, design and construction plans and documents throughout the City of San Diego including the redevelopment district of Southeastern San Diego. It is advisable to contact the City of San Diego Planning and Development Review Department early in any new construction, planning, or improvement site and/or building project.

4.6 City of San Diego Neighborhood Code Compliance

Neighborhood Code Compliance (NCC) works in partnership with the people of San Diego to promote and maintain a safe and desirable living and working environment. They strive to administer a fair and unbiased enforcement program to correct violations of property conditions and land use requirements. NCC works with Neighborhood Service Centers, the Police Department, the Livable Neighborhood Partnerships, the Housing Commission, community volunteer groups and public agencies. They participate in programs that target specific problems in San Diego communities.

Neighborhood Code Compliance enforces regulations related to the following:

- Conditions of an existing structure that constitute a clear and present danger to the public.
- Building Code violations (building, plumbing, electrical, mechanical, disabled access, etc.), including construction or change of occupancy without permits.
- California State Housing law (minimum standards for safe and sanitary housing).
- Zoning requirements for structures (use, location, configuration and size) and land use requirements.
- Grading, earth moving and retaining walls.
- Encroachments into the public right-of way and public property.

- Noise (other than airports).
- Swimming pool fences.
- Sign requirements including signs in the public right-of-way, failure to have required permits, signs in disrepair, illegal inflatable displays, balloons and pennants.

4.7 City of San Diego Storefront Improvement Program

The City of San Diego Storefront Program is part of a comprehensive approach to neighborhood revitalization. Buildings on major commercial streets located in the existing and proposed commercial Business Improvement Districts, Revitalization Areas or Livable Neighborhood Areas are eligible for assistance.

4.8 San Diego Police Department Community Relations

The purpose of the San Diego Police Department Community Relations Offices is to provide the citizens and businesses within their command area direct police outreach. They provide services such as:

- Crime prevention surveys, awareness and education.
- Neighborhood/Business Watch assistance.
- Community-Oriented Policing (COP) and Problem-Solving techniques (POP).
- Public education, interaction with local schools and Park & Recreation, etc.

The SDPD Community Relations Offices work closely with the City of San Diego's 4th District Council. One of their most important jobs is acting as a direct liaison between the community and Southeastern Division. Their goal is to create a better quality of life for those they serve.

4.9 Market Creek Plaza/Jacobs Foundation

The Jacobs Center for Nonprofit Innovation is the developer of the future Market Creek Plaza and works in partnership with community residents, nonprofit organizations, and businesses to explore new ways to invest in and strengthen neighborhoods.

The Jacobs Center is committed to assisting under-invested communities gain access to opportunities for learning, quality technical assistance and planning, as well as philanthropic support. It is also committed to reducing the time wasted in the nonprofit world on writing and screening inappropriate proposals. In keeping with these values, it seeks long-term relationships allowing the discovery of appropriate roles for investment and involvement.

4.10 San Diego Gas & Electric

San Diego Gas & Electric (SDG&E) provides assistance to local business and property owners who may have questions regarding site and building electrical utilities. Questions regarding the modification or work near underground and above ground electrical utility lines, site utility boxes, building metering, and related issues can be answered through SDG&E's community representative provided in Section 4.12.

4.11 Metropolitan Transit Development Board

The Metropolitan Transit Development Board (MTDB) oversees and operates the San Diego Trolley and related public services. The Board can be contacted through its Community and Economic Development Department for questions about community issues and services.

4.12 Sources of Assistance

Southeastern Economic Development Corporation
Paula Scribner, Business Development Manager
995 Gateway Center Way, Suite 300
San Diego, CA 92102
(619) 527-7345, fax (619) 263-6912

4th District Council Office of George Stevens
Charles Lewis, Chief of Staff
5106 Federal Blvd., #207
San Diego, CA 92105
(619) 236-6644, fax (619) 236-6529

Diamond Business Improvement District
Bill Lyons, Executive Director
Matt Brown, President and Chair
5106 Federal Blvd., #207
San Diego, CA 92105
(619) 527-0710

City of San Diego Planning and Development Review
Coleen A. Frost, Senior Planner
Community and Economic Development
202 C Street, 4th Floor
San Diego, CA 92101
(619) 235-5216

Neighborhood Code Compliance
Billie Church, Senior Zoning Investigator
4690 Market Street, Suite D-20
San Diego, CA 92102
(619) 527-5440, fax (619) 527-3469

City of San Diego Storefront Improvement Program
Alicia Martinez Higgs, Manager
1250 Sixth Avenue, 10th Floor
San Diego, CA 92101
(619) 685-1390, fax (619) 685-1391

San Diego Police Department Community Relations Offices

Officer Terri Davis-Cole (CRO)
City of San Diego Neighborhood Service Center
4690 Market Street, Suite #D90
San Diego, CA 92113
(619) 527-3487

Nancy Johnson, Community Service Officer
Southcrest Police Satellite
1410 S. 43rd Street, #F
San Diego, CA 92116
(619) 527-5490

Market Creek Plaza / Jacobs Foundation

Roque Barros, Team Member / Community Development
P.O. Box 740650
San Diego, CA 92174-0650
(619) 527-6161, 800-500-6856, fax (619) 527-6162

San Diego Gas & Electric

Jany Staley, Governmental Liaison Planner
Project Management - Metro
701-A 33rd Street
San Diego, CA 92101-3341
(619) 230-7845, fax (619) 230-7886

Metropolitan Transit Development Board

Coleen A. Frost, Senior Planner
Community and Economic Development
202 C Street, 4th Floor
San Diego, CA 92101
(619) 235-5216