

City of San Diego Public Utilities

Lake Hodges Reservoir Water Quality Assessment Study **Final Conceptual Planning Report**

June 30, 2014

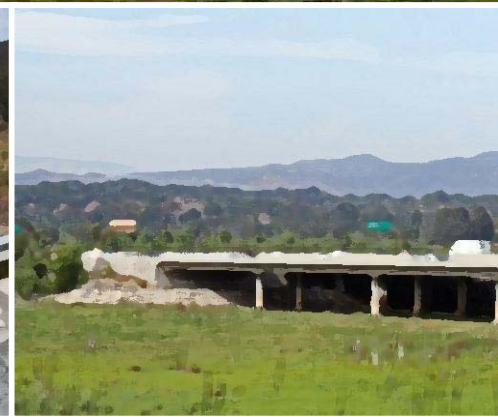

Lake Hodges Reservoir Water Quality Assessment Study

Conceptual Planning Report

Prepared for
City of San Diego
San Diego, California
July 2014



9665 Chesapeake Drive, Suite 201
San Diego, CA 92123

Acknowledgements

Brown and Caldwell acknowledges the valuable contributions made by the project Stakeholder Committee in conducting the Lake Hodges Reservoir Water Quality Improvement Project Concept Report

Specifically, the project team recognizes the following personnel for their efforts:

- City of San Diego
 - Amer Barhoumi
 - Craig Boyd
 - Rosalva Morales
 - Reynaldo Novencido
 - Jeffery Pasek
 - Surraya Rashid
 - Michael Williams
- San Diego County Water Authority
 - Jim Fisher
 - Lisa Prus
 - Toby Roy
- Santa Fe Irrigation District
 - Tim Bailey
 - Cor Shaeffer

The project team members included:

- Oliver Galang, PE, Project Manager, Brown and Caldwell
- William Faisst, PhD, PE, Technical Lead, Brown and Caldwell
- Jim Rasmus, PE, Technical Lead, Black and Veatch
- Alex Horne, PhD, Technical Lead
- Imad Hannoun, PhD, Technical Lead, Water Quality Solutions
- Andrew Cohen, Technical Lead, Aquatic Bioinvasions
- Jaime Sayre, PhD, PE, Deputy Project Manager, Brown and Caldwell



Table of Contents

List of Figures	v
List of Tables.....	vi
List of Abbreviations	vii
Executive Summary	viii
Project Overview	viii
Preliminary Cost Estimate	x
Preliminary Implementation Schedule	xi
1. Introduction	1-1
1.1 Site Description	1-1
1.2 Background.....	1-1
1.3 Summary of Challenges and Drivers.....	1-2
1.4 Project Objectives.....	1-2
1.5 Stakeholder Priorities.....	1-3
1.6 Overview of Report	1-3
2. Lake Hodges Reservoir Description.....	2-1
2.1 Site Characteristics	2-1
2.2 Current Facilities	2-3
2.3 Current Operations.....	2-5
3. Preliminary Lake Management Methods and Evaluation Workshop.....	3-1
3.1 Methods/Technologies	3-1
3.2 Evaluation Approach	3-3
3.3 Evaluation Results.....	3-3
3.4 Preliminary Alternative	3-3
3.5 Water Quality Modeling.....	3-9
3.6 Summary.....	3-11
4. Recommended Alternative	4-1
4.1 Facility Siting for Lake Management Alternative.....	4-1
4.2 Lake Hodges Reservoir Project Concept.....	4-4
4.3 Estimated Effectiveness of Recommended Alternative.....	4-8
5. Quagga Mussel Control Issues.....	5-1
5.1 Environmental Requirements and Projected Changes.....	5-1
5.2 Status of Quagga Mussels in Lake Hodges and Potential for Introduction.....	5-1
5.3 State of Quagga Mussels in Lake Hodges	5-2
5.4 Recommended Control Program for Lake Hodges Reservoir.....	5-3

6. Implementation	6-1
6.1 Planning and Permitting	6-1
6.2 Preliminary Cost Estimate.....	6-2
6.3 Preliminary Implementation Schedule.....	6-3
7. Potential Additional Studies	7-1
8. Limitations.....	8-1
9. References	9-1
Appendix A: Project Design Concept Details.....	A-1
Appendix B: Preliminary Construction Cost Estimate.....	B-1
Appendix C: Quagga Mussel Assessment	C-1
Appendix D: San Diego County Water Authority Dresissenid Mussel Response and Control Plan	D-1
Appendix E: Water Quality Model Assessment Study.....	E-1
Appendix F: Project Implementation Schedule.....	F-1
Appendix G: Stakeholder Coordination	G-1
Appendix H: Lake Hodges Natural Treatment System Options	H-1
Dudek; November 6, 2013	H-1
Appendix I: Evaluation of Lake for Phycocyanin, Technical Report.....	I-1
Blue Water Satellite; October 2, 2013	I-1



List of Figures

Figure ES-1. Preliminary Implementation Schedule.....	xi
Figure 2-1. Excessive Algal Productivity in Lake Hodges Reservoir	2-2
Figure 2-2. Overview of the Lake Hodges Reservoir and Olivenhain Reservoir System	2-5
Figure 3-1. Schematic Diagram of Speece Cone System	3-5
Figure 3-3. Lake Hodges Reservoir showing the Pump Station and the Water Quality Monitoring Stations	3-10
Figure 4-1. Location Map of Site Visit (July 2, 2013).....	4-1
Figure 4-2. Lake Hodges Dam Area, Site 1.....	4-2
Figure 4-3. Former Reservoir Operator Residence and Storage Facility Area, Site 2	4-2
Figure 4-4. Former PSP Staging Area, Site 3	4-2
Figure 4-5. Emergency Pump Storage Area, Site 4	4-3
Figure 4-6. Lake Hodges Pedestrian Bridge, Site 6	4-3
Figure 4-7. Overview of Recommended Lake Management Alternatives.....	4-3
Figure 4-8. Speece Cone for in-lake installation and diffusers	4-5
Figure 4-9. Conceptual Layout of Proposed Mid-Lake VEM System Near Boating Area.....	4-6
Figure 4-10. Conceptual Design Layout of Wetlands.....	4-7
Figure 6-1. Preliminary Implementation Schedule.....	6-3

List of Tables

Table ES-1. Estimated Order-of-Magnitude Capital Costs for Lake Hodges Reservoir Algae Control Alternatives	X
Table 3-1. Seven Identified Problems for Lake Hodges and Preliminary Assessment of Likely Causes.....	3-1
Table 3-2. Seventeen Methods for Lake/Reservoir Water Quality Management	3-2
Table 3-3. Methods Selected from Table 3-2 for More Detailed Development and Evaluation	3-3
Table 3-4. Details for the Five Selected Combined Methods	3-4
Table 4-1. Lake Hodges Siting Summary.....	4-2
Table 4-2. List of Simulations	4-8
Table 6-1. Estimated Order-of-Magnitude Capital Costs for Lake Hodges Reservoir Algae Control Alternatives	6-2
Table 6-2. Estimated Annual Operating and Maintenance Costs	6-2



List of Abbreviations

AF	acre-feet	RWQCB	Regional Water Quality Control Board, San Diego Region
AF/yr	acre-feet per year	SAV	submerged aquatic vegetation
AGR	Agricultural Supply	SCADA	supervisory control and data acquisition
BC	Brown and Caldwell	SDCWA	San Diego County Water Authority
BGA	blue-green algae	SDWD	San Dieguito Water District
CEQA	California Environmental Quality Act	SOD	sediment oxygen demand
cfm	cubic feet per minute	SVR	San Vicente Reservoir
Cu	Copper	SWAMP	Surface Water Ambient Monitoring Program
CWA	Clean Water Act	TBD	to be determined
cfs	cubic feet per second	tpd	tons per day
City	City of San Diego	UPW	Unit Process Wetland
DO	dissolved oxygen	USFWS	United States Fish and Wildlife Service
DSOD	California Department of Water Resources Division of Safety of Dams	VEM	vigorous epilimnetic mixing
DYRESM-WQ	Dynamic Reservoir Simulation Model – Water Quality	WARM	Warm Freshwater Habitat
EBMUD	East Bay Municipal Water District	WSEL	water surface elevation
ESP	Emergency Storage Project	WTP	water treatment plant
g/cm-d	grams per cubic meter per day	WWTP	wastewater treatment plant
g/sm-d	grams per square meter per day		
HA	Hydrologic Area		
HOS	hypolimnetic oxygenation system		
IND	Industrial Service Supply		
Lake Hodges	Lake Hodges Reservoir		
MeHg	methylmercury		
m	meters		
mgd	million gallons per day		
MS4	Municipal Separate Storm Sewer System		
msl	mean sea level		
MUN	Municipal and Domestic Supply		
NEMA	National Electrical Manufacturers Association		
OMWD	Olivenhain Municipal Water District		
PROC	Industrial Process Supply		
PSP	Lake Hodges Pumped Storage Project		
RARE	Rare, Threatened or Endangered Species		
REC-1	Contact Water Recreation		
REC-2	Non-Contact Water Recreation		

Executive Summary

Project Overview

Owned and operated by the City of San Diego (City) Public Utilities Department, Lake Hodges Reservoir (Lake Hodges or reservoir) is located in the San Dieguito Hydrologic Unit in San Diego County, California, and has a maximum capacity of 30,251 acre-feet with 303 square miles of upstream catchment area. It is an important part of the San Diego County Water Authority (SDCWA) Emergency Storage Projects and is needed to increase the ability to deliver water within San Diego County during significant water supply shortage. Currently, the dominant and overarching beneficial use of Lake Hodges is as a source of drinking water supply to the San Dieguito Water District/Santa Fe Irrigation District. Construction of the Hodges Pump Station and Lake Hodges-to-Olivenhain pipeline will allow Lake Hodges to be used for storage and supply to the regional water supply system operated by the SDCWA and, thus, additional usable resource of local water for the City to deliver to its water treatment plants.

Lake Hodges has several water quality challenges addressed in this report. Major water quality issues include algal productivity and eutrophication. Water quality impairments include exceedances in pH, manganese, turbidity, nitrogen and phosphorous, as well as elevated mercury and methylmercury in reservoir fish.

Objectives

The project has two main objectives:

1. Develop in-lake management actions to manage and control excessive algal productivity; and
2. Perform actions to address the 303(d) listings of water quality impairments.

Description of Water Quality Issues

Algal Production and Eutrophication

The fundamental water quality issue that needs to be addressed at the Lake Hodges Reservoir is excessive algal production or eutrophication. High algal productivity impairs the reservoir's usability as a drinking water source because of taste and odor events, high levels of disinfection by-product precursors, filter clogging, high turbidity, and contribution to anoxic conditions in the reservoir's deeper water. Thus, managing odor and taste producing algal is key to restoring and sustaining Lake Hodges' dominant and overarching beneficial use as a source of drinking water supply. Excessive loading of nutrients (in forms of nitrogen and phosphorous) and organic carbon—both external nutrient loading from the catchment and internal nutrient cycling within the reservoir—fuel high algal productivity.

Water Quality Impairments

The Regional Water Quality Control Board, San Diego Region (RWQCB) 2008 Clean Water Act Sections 305(b) and 303(d) Integrated Report states that Lake Hodges Reservoir currently does not meet water quality objectives for the following five parameters: pH, manganese, turbidity, nitrogen and phosphorous. This assessment means that current Lake Hodges conditions no longer fully support one or more of its beneficial uses. In addition, in the *Statewide 2010 Integrated Report (Clean Water Act Section 303(d) List)*, the State Water Resources Control Board (SWRCB) included mercury to the list of pollutants causing impairment in Lake Hodges. The mercury listing is based on findings in the 2009 Surface Water Ambient Monitoring Program report entitled *Contaminants in Fish from the California Lakes and Reservoirs*.

Reservoir Site and Lake Management Objectives

The Lake Hodges Reservoir Water Quality Assessment Project is limited to identifying potential in-reservoir improvements and seeks to accomplish the following objectives:

1. Evaluate existing data and records of algal (taste and odor producers) productivity, nutrients, organic carbon and contaminants in Lake Hodges. In addition, determine if trends exist and how any trends will affect the future use of Lake Hodges water in the local and regional water supply systems.
2. Review ongoing/proposed studies and determine possible impacts they may have on the Lake Hodges Reservoir Water Quality Assessment Study.
3. Evaluate methods to improve Lake Hodges water quality using the Dynamic Reservoir Simulation Model–Water Quality (DYRESM-WQ) model.
4. Produce a plan to reduce levels of pollutants in Lake Hodges that contributes to its 303(d) listed water body status.
5. Evaluate how water quality changes in Lake Hodges will impact the growth or death of Quagga Mussels. If proposed remediation methods to improve water quality stimulate Quagga growth, Consultant shall develop methods to eliminate Quagga mussels generated as a result of proposed remediation methods.

Recommended Plan

Working closely with agency staff, the Brown and Caldwell (BC) team identified and evaluated several potential alternatives to improve Lake Hodges water by decreasing algae production while addressing non-attainment issues. Section 4 and Appendix A provide details of the recommended alternatives .

BC combined the alternatives into an overall plan with several key components, presented in order of implementation priority:

1. **Speece Cone hypolimnetic oxygenation system (HOS).** A Speece Cone HOS is proposed at a site near the main dam area. The HOS would add dissolved oxygen to the reservoir’s bottom water, to prevent anaerobic conditions from occurring. Anaerobic conditions occur because algae grown near the surface eventually die and sink where bacteria breakdown the algae and similar detritus and use up available oxygen. Ending anaerobic conditions stops internal nutrient cycling. It also greatly decreases or ends methylmercury generation. The HOS would consist of a Speece Cone oxygenation system in the reservoir’s deepest water near Hodges Dam. Shoreline equipment would generate about 1 to 3 tons per day (tpd) of higher purity oxygen gas (about 93 percent oxygen by volume) for transfer into the submerged Speece Cone and submerged pump system for dissolution and discharge horizontally across the bottom.
2. **Mid-Lake Vigorous epilimnetic mixing (VEM).** A VEM is proposed at the middle section of the reservoir. The VEM would mix shallow reservoir areas to discourage the growth of potentially toxic blue green algae. VEM would use three shallow water diffuser lines each about 3,000 feet long, supplied by an air compressor system installed near the wastewater lift station. Furthermore, VEM concentrates the algae so that it could be pumped off to a wetland for removal. VEM would add oxygen to the reservoir’s shallower water.
3. **Upper Wetland filtering.** A constructed wetlands is proposed at the upper section of the reservoir. A floating pump station located along the south shoreline would pump water skimmed from the reservoir’s top half meter through a pipeline laid on the reservoir bottom, to the eastern, upstream end of a constructed wetland. A constructed wetland of about 25 surface acres located just west of the Interstate 15 bridge would receive water skimmed from the reservoir surface. Wetland depth would be about 2 feet; it would provide about two days of residence time. The wetland plants, likely bulrushes, would filter out the algae. Smaller organisms living together with the plants would decompose the algae and filtered

water would discharge back into the reservoir. Other beneficial processes such as nitrogen, phosphorus and trace constituent removal could occur in the wetland.

4. **Biomanipulation.** For Lake Hodges, biomanipulation would focus on harvesting carp that stir up the bottom sediments and hence recycle nutrients and netting out small fish that feed on zooplankton (good organisms that feed on algae).
5. **Algaecides/Molluscicides.** If Quagga mussels (or other deleterious organisms) establish themselves in Lake Hodges, the City could apply molluscicides for control.

The agencies should note that they could implement biomanipulation through fish removal in parallel with HOS. That approach could show rapid implementation if required to encourage the public about overall progress while helping to achieve overall project objectives.

Preliminary Cost Estimate

Table ES-1 summarizes the estimated order-of-magnitude capital costs for implementing the Reservoir HOS, Mid-Lake VEM, and Upper Wetland filters. These costs are current to the San Diego Area Winter 2014 and include a contingency allowance of 40 percent and an allowance of 20 percent for engineering, legal, and administrative costs. Appendix B provides details of the preliminary cost estimate.

Alternative		Engineering and Administrative Cost	Environmental Planning and Permitting Cost	Construction Cost	Total Project Cost	Comments
Number	Description					
1	Reservoir Hypolimnetic Oxygenation System	\$532,000	\$50,000	\$2,315,000	\$2,897,000	Based on a system production rate of 3 tpd. Larger systems would affect the capital cost of this alternative, e.g., a 6-tpd system would add about \$0.6 Million.
2	Mid-Lake Vigorous Epilimnetic Mixing	\$233,000	\$50,000	\$1,111,000	\$1,394,000	The VEM system is being implemented to enhance surface mixing and considered a demonstration system.
3	Upper Wetlands Filtering	\$1,885,000	\$377,000	\$7,538,000	\$9,800,000	Upper Wetlands for algae filtering is based on an estimated 30-acre site with a net 25-acre area for water treatment.



Preliminary Implementation Schedule

It is recommended that the proposed projects are implemented in phases, starting with the Reservoir HOS, Mid-Lake VEM, and then the Upper Wetlands.

Schedule Assumptions

Figure ES-1 below presents the projected schedule for design, permitting, and construction. The following assumptions were used to develop the schedule below.

- The City will conduct an Environmental Assessment to determine the appropriate documentation required under California Environmental Quality Act. In addition, the City will identify the regulatory permits, which may include the California Department of Fish and Wildlife, Regional Water Quality Control Board, and US Army Corps of Engineers.
- The implementation approach for these project alternatives will follow the traditional design, bid, build method of delivery. The City may consider an alternative method, such as design-build, to expedite the delivery schedule.
- We estimate the overall implementation schedule for the Reservoir HOS and the Mid-Lake VEM to each require 9 to 12 months for design and permitting, 3 months for bidding and award, and 9 to 12 months for fabrication and installation.
- For the Upper Wetlands, it is estimated that the process may require 18 months for design and permitting, 3 months for bidding and award, and 12 months for construction.

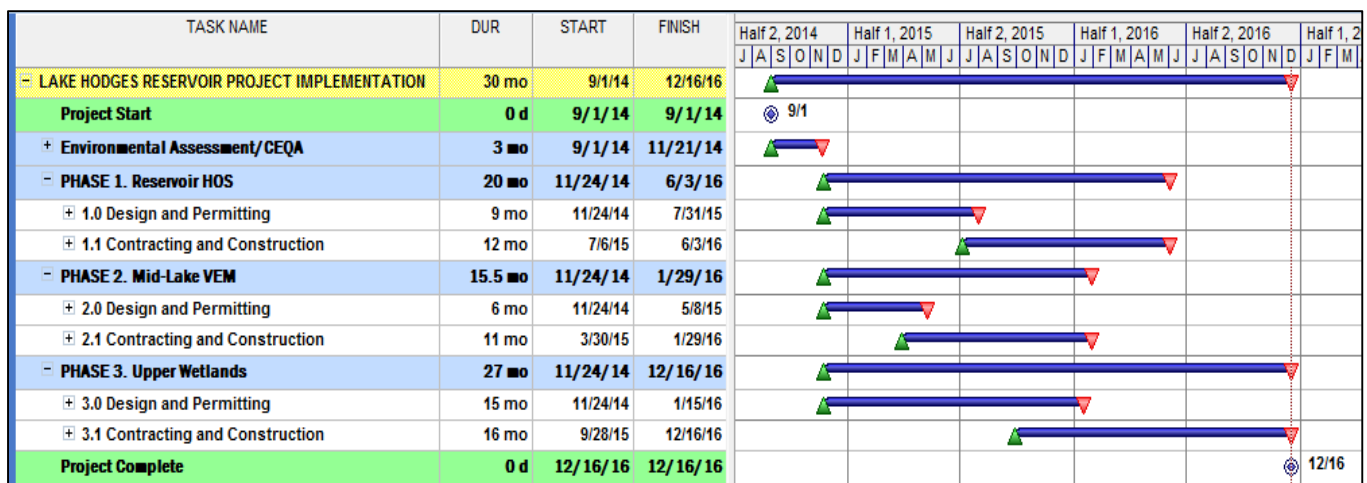

Figure ES-1. Preliminary Implementation Schedule



Section 1

Introduction

1.1 Site Description

Owned and operated by the City of San Diego (City) Public Utilities Department, Lake Hodges Reservoir (Lake Hodges or reservoir) is in the San Dieguito Hydrologic Unit in San Diego County, California, and has a maximum capacity of 30,251 acre-feet (AF) with 303 square miles of upstream catchment area. It is an important part of the San Diego County Water Authority (SDCWA) Emergency Storage Projects and is needed to increase the ability to deliver water within San Diego County during significant water supply shortage. Currently, the dominant and overarching beneficial use of Lake Hodges is as a source of drinking water supply to the San Dieguito Water District (SDWD)/Santa Fe Irrigation District (SFID). Construction of the Hodges Pump Station and Lake Hodges-to-Olivenhain pipeline allows Lake Hodges to be used for storage and supply to the regional water supply system operated by the SDCWA and, thus, additional usable local water resource for the City. The City is a member agency of the SDCWA.

Lake Hodges and the San Pasqual Valley are located within the San Dieguito River Valley. The headwaters of the San Dieguito River watershed (Santa Ysabel Creek) originate on Volcan Mountain, approximately 30 miles from the Lake Hodges dam. Santa Ysabel Creek flows through the San Pasqual Valley and, at the confluence with Santa Maria Creek, becomes the San Dieguito River. The Lake Hodges/San Pasqual Valley open space has gently sloping topography along the valley floor and steep, rugged topography in the adjacent hills. Elevations range from 180 feet mean sea level (msl) in the river channel below the Lake Hodges spillway to approximately 1,800 feet msl on the slopes at the open space eastern end. The Lake Hodges spillway is at an elevation of 315 feet msl. Several tributary canyons across the open space, including Sycamore Canyon, Cloverdale Canyon, Rockwood Canyon, Bandy Canyon, Schoolhouse Canyon and Clevenger Canyon, contribute flow within the watershed. Several notable mountain peaks surround the study area: Bernardo Mountain (1,150 feet) on the north shore of Lake Hodges, Battle Mountain (803 feet) south of the lake, Cranes Peak (1,054 feet) at the east end of San Pasqual Valley, and Starvation Mountain (2,140 feet) south of San Pasqual Valley and Highland Valley (LAG_SanDiego PDF).

1.2 Background

The Water Quality Control Plan for the San Diego Region (9), commonly known as the Basin Plan, lists ten beneficial uses for Lake Hodges: Municipal and Domestic Supply (MUN); Agricultural Supply (AGR); Industrial Service Supply (IND); Industrial Process Supply (PROC); Contact Water Recreation (REC-1) (fishing from shore or boat permitted, but other forms of water contact recreational uses are prohibited); Non-contact Water Recreation (REC-2); Warm Freshwater Habitat (WARM); Cold Freshwater Habitat (COLD); Wildlife Habitat (WILD); and Rare, Threatened or Endangered species (RARE). The highest priority beneficial use of Lake Hodges is drinking source water supply, which the Basin Plan catalogs as MUN.

The Regional Water Quality Control Board, San Diego Region (RWQCB), 2008 Clean Water Act Sections 305(b) and 303(d) Integrated Report states that Lake Hodges currently does not meet water quality objectives for the following five parameters: pH, manganese, turbidity, nitrogen and phosphorous. This assessment means that one or more of the lake's beneficial uses are no longer fully supported. In addition, the State Water Resources Control Board (SWRCB) has listed Lake Hodges reservoir in the "Statewide Mercury Control Program for Reservoirs," as discussed further in Section 2.1.2.

While these impairment listings of Lake Hodges are significant and need to be addressed, they are not the most important water quality issue to be remedied. The key, fundamental water quality matter that needs to be “fixed” at Lake Hodges is excessive algal productivity or eutrophication. High algal productivity impairs the reservoir’s usability as a drinking water source because of taste and odor events, high levels of disinfection by-product precursors, filter clogging, high turbidity, and anoxic conditions in the reservoir’s deep water. Thus, managing odor and taste producing algal is key to restoring and sustaining Lake Hodges’ dominant and overarching beneficial use as a source of drinking water supply. High algal productivity in the reservoir is fueled by excessive loading of nutrients (forms of nitrogen and phosphorous) and organic carbon—both external—loading of nutrients from the catchment and internal cycling of nutrients within the reservoir.

1.3 Summary of Challenges and Drivers

Lake Hodges has several water quality challenges addressed in this report. Major water quality issues include algal productivity and eutrophication. Water quality impairments include exceedances in pH, manganese, turbidity, nitrogen and phosphorous. Furthermore, the State Water Resources Control Board (SWRCB) has added mercury and methylmercury to the listed impairments since fish from Lake Hodges have elevated mercury levels. Another challenge further discussed is how changes to water quality will affect the Quagga mussel populations or the possibility of Quagga mussel establishment in Lake Hodges.

1.4 Project Objectives

The project has two main objectives:

1. Develop in-lake management actions to manage and control excessive algal productivity; and
2. Perform actions to address the 303(d) listings of water quality impairments.

1.4.1 Reservoir Site and Lake Management Objectives

The Lake Hodges Water Quality Project is limited to identifying potential in-reservoir improvements and seeks to accomplish the following objectives:

1. Evaluate existing data and records of algal (taste and odor producers) productivity, nutrients, organic carbon and contaminants in Lake Hodges. In addition, determine if trends exist and how any trends will affect the future use of Lake Hodges water in the local and regional water supply systems.
2. Review ongoing/proposed studies and determine possible impacts they may have on the Lake Hodges Water Quality Assessment.
3. Evaluate methods to improve Lake Hodges water quality using the Dynamic Reservoir Simulation Model-Water Quality (DYRESM-WQ) model.
4. Produce a plan to reduce levels of pollutants in Lake Hodges that contributes to its 303(d) listed water body status.
5. Evaluate how water quality changes in Lake Hodges will impact the growth or death of Quagga mussels. If proposed remediation methods to improve water quality stimulate Quagga growth, Consultant shall develop methods to eliminate Quagga mussels generated as a result of proposed remediation methods.

1.4.2 Regulatory Objectives

For Lake Hodges Reservoir, the City has identified two key regulatory objectives:

- Meet water quality objectives for the following five parameters: pH, manganese, turbidity, nitrogen and phosphorous.
- Prepare to meet potential future limitations for mercury and methylmercury.

This report will discuss and evaluate methods to increase the water quality in Lake Hodges and to meet these water quality objectives.

1.5 Stakeholder Priorities

The following governmental agencies regulate the Lake Hodges Reservoir Projects:

- California Department of Fish and Wildlife
- California Department of Industrial Relations
- California Department of Water Resources - Division of Safety of Dams (DSOD)
- California Independent System Operator
- California Office of Emergency Services
- California Department of Public Health
- California Regional Water Quality Control Board (RWQCB), San Diego Region
- City of San Diego
- County of San Diego
- U.S. Army Corps of Engineers
- United States Fish and Wildlife Service (USFWS)

1.6 Overview of Report

This Water Quality Conceptual Planning Report is comprised of seven sections:

- Section 1: Introduction
- Section 2: Lake Hodges Description
- Section 3: Preliminary Lake Management Methods and Evaluation Workshop
- Section 4: Recommended Alternative
- Section 5: Quagga Mussel Control Issues
- Section 6: Implementation
- Section 7: Potential Additional Studies

Section 2

Lake Hodges Reservoir Description

2.1 Site Characteristics

2.1.1 General Description

Lake Hodges Dam and Reservoir is located in Southern California, about 30 miles north of San Diego and just south of Escondido, California. Lake Hodges Reservoir was created with the construction of Hodges Dam along the San Dieguito Creek in 1918. Owned and operated by the City Public Utilities Department since 1925, the reservoir currently serves the San Dieguito Water District and the Santa Fe Irrigation District, as well as the City. When full, the reservoir at the spillway elevation of 315 feet, has a surface area of 1,234 acres, a maximum water depth of 115 feet and 27 miles of shoreline.

2.1.2 Physical

2.1.2.1 Climate

The year-round climate of southwestern California and San Diego County is typically very mild and is moderated by the proximity of the ocean. The climate in the Lake Hodges Reservoir area (near the City of Escondido) and San Pasqual Valley region is characterized by warm, generally dry summers and cool, wet winters, with substantial year-to-year variations in temperature and precipitation.

The annual average temperature in the Hodges Reservoir/Escondido area is 62.0°F. The warmest months on average, are July and August with an average temperature of 73.0°F. Monthly average minimum temperatures vary from 38.3°F in December to 59.6°F in August. Monthly average highest temperatures vary from 74.4°F in January to 94.3°F in July and September (Source: www.weatherbase.com).

The average annual precipitation in the City of San Diego, as officially measured at San Diego-Lindbergh Field, is about 10 inches, with average monthly precipitation being highest in January at 2 inches and lowest in July at 0.1 inch. Average annual precipitation within the San Dieguito Hydrologic Unit ranges from about 13 inches at Oceanside to 17 inches at Escondido, to almost 40 inches at Cuyamaca near the eastern end of the San Dieguito Hydrologic Unit (Ogden, 1996). The average annual precipitation at Lake Hodges is about 14 inches as observed by the City (Lake Hodges Projects Reservoir Regulation Manual, 2008).

2.1.2.2 Watershed

The Lake Hodges Reservoir/San Pasqual Valley open space lies within the middle of the San Dieguito watershed (San Dieguito Hydrologic Unit). Drainage from the Santa Ysabel Hydrologic Area (HA), Santa Maria HA, San Pasqual HA, and the Hodges HA (RWQCB 1994) feed the open space. These HAs collectively drain an area of 192,585 acres (about 301 square miles); the flow enters Lake Hodges Reservoir. Lake Sutherland, constructed in the 1950s, controls the watershed's upper end, an area of 34,968 acres. Water from Lake Sutherland is transported to the community of Ramona and out of the watershed to San Vicente Reservoir. Stream flow in the main stem San Dieguito River and Santa Ysabel Creek is intermittent. With the exception of very high rainfall years, the creek has no flow during later summer and fall months. During the 1944 to 2000 period, the average annual mean daily flow at the Santa Ysabel stream gage (at the eastern end of the open space) was 11.76 cubic feet per second (cfs). Discharge in Santa Ysabel Creek is variable. The average annual maximum daily discharge was 486.15 cfs, the average annual median daily discharge

was 1.96 cfs, and on January 27, 1916, a maximum daily discharge of 14,100 cfs was recorded. Several significant tributary drainages flow into the Lake Hodges/San Pasqual Valley open space: Guejito Creek, Santa Maria Creek, Sycamore Creek, Cloverdale Creek, Green Valley Creek and Kit Carson Creek. The Santa Maria Creek is the only tributary in the open space with a stream gage. Over the period 1947-2000, the average annual daily discharge in Santa Maria Creek was 6.58 cfs, the average annual maximum daily discharge was 339.69 cfs, and the average annual median flow was 0.17 cfs. The maximum observed average daily discharge of 4,960 cfs was also recorded on January 27, 1916 (LAG_SanDiego PDF).

2.1.3 Water Quality

Section 1.2 summarizes water quality regulations and challenges for Lake Hodges Reservoir.

The Regional Water Quality Control Board, San Diego Region (RWQCB), 2008 Clean Water Act Sections 305(b) and 303(d) Integrated Report states that Lake Hodges currently does not meet water quality objectives for the following five parameters: pH, manganese, turbidity, nitrogen and phosphorous. This assessment means that one or more of the lake's beneficial uses are no longer fully supported.

The impairments identified under the 303(d) list are primarily a result of eutrophic conditions due to the nutrient loading. Algae production from nutrient loading is the primary concern, especially since algae decomposition in the reservoir's deeper water causes nutrient cycling and can reduce and release iron and manganese and produce methylmercury. Figure 2-1 illustrates the excessive algal productivity present in Lake Hodges Reservoir. The only effective way to address the impairments is through lake management and watershed controls.



Figure 2-1. Excessive Algal Productivity in Lake Hodges Reservoir

Methylmercury

The SWRCB has listed Lake Hodges Reservoir in the "Statewide Mercury Control Program for Reservoirs." The principal SWRCB concern is methylmercury (MeHg) formation and its bioaccumulation in the food chain. Based on scientific research and water industry experience across the United States, the best control for mercury is prevention of MeHg formation. Research has shown that sulfate reducing organisms produce MeHg as a byproduct of sulfate reduction to sulfide, a reaction that occurs under anaerobic conditions. If the City can prevent sulfate reduction, it effectively will stop MeHg formation. Mercury methylation mainly occurs in the sediments but also might occur in the water column if anaerobic conditions persist there. For sulfate reduction to occur, not only must the reservoir waters or sediment become anaerobic (no oxygen present) but the electrochemical potential must decrease well below zero, perhaps to readings on the order of -300 millivolts. Even maintaining a low level of dissolved oxygen (DO) on the order of 0.5 mg/L would be sufficient to prevent sulfate reduction and hence, MeHg formation. The proposed oxygen addition, particularly through the Speece Cone hypolimnetic oxygenation system (HOS) but also including the vigorous epilimnetic mixing (VEM), would maintain an oxic cap on the sediment while keeping the water column DO positive. The reader should note that the City needs to maintain aerobic conditions (sediment water column interface and water column) continuously. While operation of the HOS and VEM should stop mercury methylation very rapidly, the decrease in food chain MeHg will occur gradually—likely over a period of years. This phenomena would occur because of methylmercury already in the food chain.

2.1.4 Biological

Lake Hodges Reservoir has the potential to support an infestation by Quagga mussels; however, the current environmental variables may be a factor in preventing this. Sampling has detected larval stage Quagga mussels on several occasions, but sampling thus far has detected no adult Quagga mussels. Olivenhain Reservoir receives water from the Colorado River which may contain active adult Quagga mussels. Any inputs from Olivenhain Reservoir or the imported water supply can potentially increase the risk of Quaggas in Lake Hodges Reservoir. In addition, boating and other recreation activities in Lake Hodges, if not properly monitored or detected, also can pose a risk. Poor water quality in Lake Hodges now may be impeding the Quagga growth. Water quality improvements have the potential to encourage Quagga growth and infestation, and therefore should be a consideration.

2.2 Current Facilities

The following subsections summarize characteristics for existing facilities.

2.2.1 Hodges Dam

In 1918, the San Dieguito Mutual Water Company constructed Hodges Dam on the San Dieguito River. The dam is located approximately 30 miles north of San Diego. In 1925, the City purchased Hodges Dam and its associated facilities. Water was released from the reservoir through a 36-inch-diameter steel pipe to the 4.5-mile-long Hodges Flume, which conveyed water by gravity to San Dieguito Reservoir. Constructed in 1917, the concrete flume had a capacity of about 21 cfs (13.5 million gallons per day [mgd]). Supported by trestles through steep terrain, portions of the flume were highly susceptible to damage resulting from earthquake movement. In addition, the flume received considerable sediment inflow and was subject to recurrent vandalism. The City replaced the flume with a pipeline in 2003 that has a capacity of about 34 cfs (22 mgd).

The City water surface gage at Lake Hodges Reservoir has a datum of 200 feet msl located near the streambed elevation at the dam. The deepest point in the lake is and an elevation of about 225 feet (gage 25 feet), but there are only about 50 acres and fewer than 400 AF at 250 feet elevation (gage 50 feet). The dam top is at 330 feet elevation (gage 130 feet). The spillway elevation is at 315 feet (gage 115 feet). The original storage capacity was about 33,550 AF. The maximum capacity is now (1995 hydrographic survey) estimated to be about 30,250 AF.

Hodges Dam is a multiple-arch, reinforced-concrete structure with a 342-foot-long uncontrolled overflow spillway and crest elevation of 315 feet msl. The spillway crest consists of a 202-foot-long ogee weir section and 140-foot-long broad-crested weir section. The spillway design capacity is 67,440 cfs, with a water surface of 325 feet (i.e., flow depth of 10 feet over weir). The dam crest has a length of about 730 feet (including the 342-foot spillway section) and rises roughly 130 feet above the streambed. The reservoir has a 1,234-acre surface area at a spillway crest of 315 feet msl. The reservoir is open to the public for recreational uses such as fishing, power boating, hiking, biking, picnicking, and boardsailing as well as equestrian use (trails).

The Hodges Dam outlets consist of five horizontal box openings on the upstream face of the dam. The elevations from which water could be drafted from the reservoir are 254, 264, 275, 284, and 294 feet msl. The box openings are about 5 feet high and are protected with bar screens. The downspouts are 20-inch-diameter cast iron pipes with concrete embedded gate valves. The two lowest 20-inch-diameter outlets discharge directly into a 36-inch-diameter steel pipe that discharges to the pipeline that replaced the Hodges Flume. However, the lowest outlet at elevation 255 feet has silted over and is no longer useable. The dam was equipped with four 24-inch sluicing outlets in the central arches for draining of the reservoir at elevation 206 feet, with a combined discharge of about 180 cfs. However, these river outlets also are covered with

sediments and no longer useable. Water released from Lake Hodges Reservoir flows by pipeline to the Badger Filter Plant or to San Dieguito Reservoir (capacity of about 400 AF). The pipeline has a capacity of about 34 cfs (22 mgd). The Badger Filter Plant, jointly owned and operated by the SFID and SDWD, treats water transferred from Lake Hodges Reservoir directly or from San Dieguito Reservoir. The Badger Filtration Plant also treats water from the SDCWA Second Aqueduct. About 20 percent (4,500 AF per year [AF/yr]) of the total treated water supply of 21,000 AF/yr has come from Lake Hodges in recent years.

2.2.2 Lake Hodges Pumped Storage Project

The Lake Hodges Pumped Storage Project (PSP) is a significant element of the SDCWA's Emergency Storage Project (ESP) and enables water to be pumped between Lake Hodges and the Olivenhain Reservoir for emergency water supply storage. PSP operations at Lake Hodges would maintain a minimum storage of about 10,400 AF at a water elevation of 290 feet from the end of November until the end of February. In the spring (i.e., March and April), Lake Hodges storage would be increased to about 14,500 AF at a water elevation of 297 feet, with imported water used if local runoff was not sufficient to increase storage in Lake Hodges. The Lake Hodges drawdown in the fall (i.e., October and November) would allow Lake Hodges to capture and store about 20,000 AF of local runoff in Lake Hodges during the late fall and winter rainfall season if sufficient runoff occurs. This strategy will maintain relatively constant water levels in Lake Hodges through the year while allowing for maximum PSP operation.

The pumping plant connecting Lake Hodges and Olivenhain Reservoir has a capacity of about 590 cfs (1,200 AF per day). Therefore, in addition to the 20,000 AF of storage space in Lake Hodges, an additional 1,200 AF per day can be captured by pumping to Olivenhain Reservoir (6,000 AF of seasonal storage space) and then releasing some (i.e., 168 cfs or 333 AF/day) to the aqueduct during periods of runoff. When this water is released from Olivenhain Reservoir to the aqueduct (Pipeline 5), the fraction of aqueduct water from Olivenhain Reservoir could be relatively high, depending on the winter flow in Pipeline 5. This fraction of untreated aqueduct (Pipeline 5) water released from Olivenhain Reservoir would be based on established water quality thresholds and estimated on a monthly basis. This information can be used together with the simulated water quality released from Olivenhain Reservoir to estimate the effects on water treatment plants that use Pipeline 5 water.

PSP operations are limited to a maximum daily exchange between Olivenhain Reservoir and Lake Hodges of about 600 AF/day. The PS operations would pump 600 cfs for 12 hours and then release 600 cfs for 12 hours. On a daily average basis, this operation is equivalent to an exchange flow of 300 cfs pumped from Lake Hodges into Olivenhain Reservoir and 300 cfs released from Olivenhain Reservoir into Lake Hodges. An exchange flow of 500 AF/day was assumed as a monthly average, allowing for some weekly variation in the PSP flows. The actual operation of the PSP facility is likely to be considerably less, because it will be used primarily as a peak standby unit (similar to a gas turbine).

Lake Hodges water delivery to the Badger Filtration Plant has fluctuated somewhat in recent years, depending upon water availability in Lake Hodges. Water rights agreements between the City and the SFID, and SDWD may limit future delivery of Lake Hodges water. Pipeline capacity of about 34 cfs (22 mgd) would limit seasonal maximum delivery, producing a maximum likely diversion pattern totaling 8,000 AF, with a maximum diversion flow of 18 cfs in the summer (1,080 AF/month). This delivery is about 40 percent of the combined annual delivery for SFID and SDWD (21,000 AF). This volume also is close to the expected annual water yield of Lake Hodges under the ESP operations, where 20,000 AF will be available for storage of local runoff each winter. The assumed Lake Hodges water delivery to the Badger Filter Plant is important because this delivery allows a greater seasonal Lake Hodges emergency storage drawdown without pumping Lake Hodges water back into Olivenhain Reservoir and the aqueduct. Lake Hodges water delivery reduces delivery to the Badger Filter Plant from the aqueduct.

2.2.3 Olivenhain Reservoir

The CWA owns and operates the Olivenhain Dam and Reservoir. In 2003 the CWA and the Olivenhain Municipal Water District (OMWD) constructed the dam as part of the ESP with the primary purpose for municipal water supply. Olivenhain Reservoir is filled with imported water from the Second Aqueduct. Olivenhain MWD no longer controls storage in Olivenhain Reservoir. Olivenhain Reservoir may be filled with Second Aqueduct water throughout year to maintain storage level targets for ESP and PS operations.

The reservoir has a maximum depth of about 280 feet, with a bottom elevation of 800 feet and a spillway crest elevation of 1,080 feet. The maximum reservoir volume is about 24,000 AF, with a surface area of about 200 acres.

The OMWD water treatment plant, constructed at the Olivenhain Dam base, has a capacity of about 62 cfs (40 mgd).

2.3 Current Operations

2.3.1 Water Rights and Contracts

The City owns and operates the existing Lake Hodges Dam and Reservoir, located within the San Dieguito River drainage. The City has contractual obligations to supply water from Lake Hodges Reservoir to SFID and San Dieguito Water District under the terms and conditions of the March 16, 1998 City Agreement with the Districts (City Document No. 00-18474, March 1998).

The City may request the SDCWA to draw water from Lake Hodges during high runoff years, provided that water quality parameters are met. The year to year lake level is mostly driven by SDCWA's need to operate the pump station.

2.3.2 Water Supply Operations

Normal operating conditions consist of water supply operations and pumped storage operations. Water supply operations typically require large fluctuations of Lake Hodges storage over the course of a year, and are monitored on a month-to-month, or seasonal basis. The pumped storage operations for electricity generation using the PS facilities consist of day-to-day exchanges of Lake Hodges water and Olivenhain Reservoir water, with no net weekly change in the storage amounts in either reservoir. The changes in the reservoir level is primarily controlled by the pumped storage operations.

The minimum storage level has been about 275 feet and the minimum storage volume about 5,000 AF. The spillway crest at elevation of 315 feet corresponded to a maximum storage of about 30,250 AF. This new (i.e., reduced) storage estimate was used for the City's hydrology record during the filling in 2005.



Figure 2-2. Overview of the Lake Hodges Reservoir and Olivenhain Reservoir System

The SFID and SDWD have attempted to obtain as much water supply as possible from Lake Hodges, limited only by flume (or pipeline) capacity in wet years with high Lake Hodges storage. They have used much more than the 2,000 AF/yr that is mandated in the agreement with the City. The remainder of their water supply is purchased from the CWA Second Aqueduct (untreated).



Section 3

Preliminary Lake Management Methods and Evaluation Workshop

3.1 Methods/Technologies

Working with Dr. Alex Horne and agency representatives, the BC team developed an array of potential management methods for Lake Hodges. The agencies held a workshop on June 17, 2013, to develop and screen potential lake management methods into one or more alternative(s). These 17 methods are based upon study and research carried out by Dr. Horne over the past 40 plus years. While the City's major concern is algae and algae-related problems, and the City must meet water quality objectives; water quality is too broad a category for the 17-method analysis. Therefore, several of the 17 methods come together into an overall approach. The City also has expressed a concern that successful algae management could inadvertently cause a new problem, by making the water more hospitable for Quagga mussel growth. Section 5 describes and addresses Quagga issues.

Table 3-1 presents a problem summary for Lake Hodges and an initial assessment of likely causes.

Table 3-1. Seven Identified Problems for Lake Hodges and Preliminary Assessment of Likely Causes

Problem to be addressed	Probable cause	Other possible causes
Excess algae	High nutrients, warm temperatures, low grazing of algae by zooplankton on phytoplankton (free –floating algae). High ratios of watershed area:reservoir area (greater than 100:1 for Lake Hodges Reservoir)	Shallow lake areas give habitat for attached algae
Taste and odor (T and O) (organic)	Planktonic BGA, likely geosmin	Benthic BGA, likely 2-Methylisoborneol
Taste & odor (hydrogen sulfide)	Eutrophication (low bottom DO)	Elevated sulfate in local runoff
Iron and Manganese	Reducing conditions at top of deep water sediment	
Meet water quality objectives	Excess algae	Reservoir shape (extensive shallow areas and flashy, turbid runoff)
Quagga mussels	Inflows from contaminated sources; algae control and possible deeper aerobic layer extends potential mussel habitat	
Maintain cold water habitat	Loss of stratification owing to vertical mixing	
Mercury/methylmercury	Sulfate reduction to sulfide when sediment surface becomes anoxic	

BGA = blue green algae

Table 3-2 describes 17 identified methods for managing water quality within a lake or reservoir and presents an initial screening of its possible applicability for Lake Hodges. Note that some methods will overlap and will then collapse into single management strategies.

Table 3-2. Seventeen Methods for Lake/Reservoir Water Quality Management

Method		Applicability for Lake Hodges	Use
1	Dredging	Not applicable except in limited areas. Has high cost and likely results in limited benefit (?) – may be benefit with new water source	No
2	Water level fluctuation	Occurs already. Lake Hodges shows no edge weed problems.	No
3	Mixing and/or destratification	High applicability for VEM in shallower, mid-reservoir regions, de-stratification near dam not advisable (see Item 11)	Yes
4	Macrophyte harvesting	None present, weeds not a current problem	No
5	Wetland filters (off-line)	High applicability, locate above reservoir's upper end of reservoir; can also be used for treatment of summer and some winter urban contaminated runoff.	Yes
6	Algae harvesting	Possible for blue-green algae scums, but only in conjunction with Method 5 in algae corralling device. Attached green algae in shallow areas could be harvested but do not appear to present a future problem.	Yes
7	Selective withdrawal of hypolimnion	Occurs already via deep drinking water outlets. Deep water quality will improve considerably with HOS installation and operation.	Yes
8	Dilution/flushing	Will occur with new pump storage but is not factored in eutrophication concepts. Volumes exchanged from deeper water probably not large enough to cause large algal reduction	TBD
9	Sediment sealing (fabrics)	Not applicable, no rooted weed growths around docks or beaches	No
10	Algaecides/herbicides or molluscicides	Emergency use only; high cost and regulatory problems downstream after WWTP (e.g., aquatic biota sensitive to copper [Cu]). Molluscides might be appropriate if future conditions warrant their consideration. Improved products apparently are becoming commercially viable.	Rare
11	Oxygenation/aeration	Oxygenation in lower stratified reservoir (added using the HOS) would reduce internal nutrient loading & eliminate much taste and odor	Yes
12	Shading/dyes	Not applicable; reservoir too large so cost high and benefits would have limited duration, only for month or two	No
13	Sediment sealing (chemical, alum, etc.)	Possible application but large storm water P-loads and exchange with upper P-rich shallow waters make cost of regular applications high. Not needed if other methods work	No
14	Pathogens/diseases of algae	Not recommended; method still in research, immunity buildup in BGA and cost high for larger reservoirs	No
15	Grazers (on algae or macrophytes)	Not needed since Lake Hodges has no macrophyte problem. Algae grazing by zooplankton will be enhanced using Method 11 and Method 17	No
16	Nutrient harvesting from fish/weeds	Not recommended as standalone; only few percent annually can be removed at best but some removal will occur as part of Method 17	No
17	Biomanipulation	Recommended: remove carp and excess tiny fish that eat large zooplankton (Method 11) and consider a new design floating or static wetland refuges for zooplankton to compensate for the lack of shoreline submerged plants.	Yes

TBD = To Be Determined when modeling results are available; WWTP = wastewater treatment plant

3.2 Evaluation Approach

The project team carried out a preliminary evaluation of the 17 methods to determine the applicability and suitability for implementation in Lake Hodges. Factors considered included the characteristics of water quality challenges and the reservoir’s physical characteristics.

3.3 Evaluation Results

Table 3-3 lists the methods judged to have more applicability and suitability for Lake Hodges, given the characteristics of the water quality challenges and reservoir’s physical characteristics.

Table 3-3. Methods Selected from Table 3-2 for More Detailed Development and Evaluation			
Method		Applicability for Lake Hodges	Use
3	Mixing & destratification	High applicability for VEM in shallower mid-reservoir regions	Yes
5	Wetland filters (off-line)	High applicability, locate above upper end of reservoir; can also be used for summer & some winter urban contaminated runoff. May need Unit Process Wetland design.	Yes
6	Algae harvesting	For blue-green algae scums, can be combined with #5 in algae corralling device	Yes
7	Selective withdrawal of hypolimnion	Occurs already via deep drinking water outlets	Yes
8	Dilution/flushing	Will occur with new pump storage but is not factored in eutrophication concepts. Volumes exchanged from deeper water probably not large enough to make large algal reduction	TBD
10	Algaecides/herbicides or molluscicides	Emergency use only; high cost and regulatory problems downstream after WTP (e.g., aquatic biota sensitive to Cu).	Rare
11	Oxygenation/aeration	Oxygenation in lower stratified reservoir (operate HOS) would reduce internal nutrient loading and eliminate much taste and odor.	Yes
17	Bio-manipulation	Recommended to remove carp. To increase zooplankton (Method 11), carry out annual or biannual small fish netting in early summer. Use a new design of floating wetland refuges for large zooplankton.	Yes

WTP = water treatment plant

3.4 Preliminary Alternative

Review and further screening of information presented above led to the five classes of in-lake treatment selected for Lake Hodges to the final combined methods listed in Table 3-4. In order of priority, based on direct impact of water quality, they are:

- Speece Cone HOS
- VEM vigorous epilimnetic mixing with algae scum corralling
- Wetland filters for algae and other pollutants
- Bio-manipulation
- Algaecides/molluscicides

Table 3-4. Details for the Five Selected Combined Methods

Modified Method		Applicability for Lake Hodges
A	HOS using a Speece Cone in the deeper, thermally stratified lower reservoir	Method maximizes oxygen additions to the sediment-water interface to reduce internal nutrient loading; inhibited nutrient cycling lowers algae concentrations and taste and inorganic taste and odor formation
B	VEM combined with algae coralling	Reduces scumming blue-green algae in shallower mid and possibly upper reservoir regions, directs scums to collection points from where new equipment would skim and pump to wetlands for filtration and removal
C	Wetland filters (off-line) will include Algae coralling prior to harvesting (removal in wetland)	High applicability, locate above upper end of reservoir; can also be used for summer & some winter urban contaminated runoff For blue-green algae scums, can be combined with #5 in algae coralling device
D	Bio-manipulation	Remove as many carp as is feasible to reduce nutrient recycling in shallow waters. To increase large algae-eating zooplankton and consider a new design floating wetland refuges for zooplankton from fish predation.
E	Algaecides/herbicides/molluscicides (and other Quagga treatments)	Emergency use only; high cost and regulatory problems downstream after WTP (aquatic biota sensitive to Cu, PAC20 cost high, other molluscicides).

More detailed descriptions appear in the following subsections.

3.4.1 Hypolimnetic Oxygenation Systems

Both aeration and oxygenation systems were assessed during alternatives development. Since one beneficial use of Lake Hodges Reservoir is a cold water fishery, any system for adding oxygen needs to maintain density stratification. Aeration does not maintain stratification and hence was eliminated. The options for hypolimnetic oxygenation include a pressurized oxygenation vessel (e.g., a Speece cone) approach and fine bubble addition with soaker hoses. A key objective for hypolimnetic oxygenation is adding oxygen at the top of the water-sediment interface on the lake's bottom. This oxygen addition prevents the sediment surface from becoming anaerobic and stops nutrient cycling. Experience with operating systems has shown that the Speece cone systems, which discharge an oxygenated plume horizontally, are far more effective in placing oxygenated water directly on bottom sediments. In contrast, the bubble plume systems transfer oxygen into a rising plume but do not focus oxygen directly on the important critical sediments.

The technique of adding pure oxygen gas to deep anoxic water is well established based on the success of early tests in the 1980s leading to the flagship installation and study and implementation of HOS in Camanche Reservoir (425,000 AF), California by East Bay Municipal Utility District (EBMUD) in 1993. The EBMUD system has operated continuously from spring through fall for 20 years. Resulting water quality improvements include large reductions in taste, odor, algae and nutrients. The downstream fishery in the Mokelumne River has improved as has the quality of water released to the Mokelumne River Fish hatchery that draws water from the reservoir release. In general, a HOS adds oxygen to the hypolimnion of deeper lakes and reservoirs to make up for that lost by bacterial decay of algae that have sunk down from surface waters.

In the United States, the water industry generally uses two basic HOS systems now commercially available—those using free bubbles and those where the bubbles are pre-dissolved under pressure prior to release to the lake. BC estimates that in the United States about 50 Speece-Cone-type HOS systems are installed and operating in lakes, reservoirs, rivers and harbors. Other HOSs includes a widely applied Mobley-TVA rising bubble system and a closed, onshore pressurized device (Blue-in-Green) that has had little use so far in lakes. If the HOS purpose is water quality improvement (in particular decreasing bottom water nutrient releases), preventing iron and manganese reduction, and decreasing overall BGA production, then a bubble-

free plume directed horizontally across the sediments is most effective. EBMUD constructed such a system at Camanche Reservoir. Regular monitoring showed an algae reduction of 90 percent and elimination of bottom water hydrogen sulfide. Two commercial manufacturers provide HOSs; one from ECO Oxygen Technologies, LLC using a Speece Cone (named after Dr. Richard Speece, Professor Emeritus of Civil Engineering at Vanderbilt University, Tennessee). Some agencies have contracted out fabrication of Speece Cones or fabricated systems themselves. The Speece Cone system sites the cone in the deep lake water and uses the resultant hydrostatic pressure to increase oxygen solubility and, hence, oxygen transfer into water pumped through the system. The other is Blue-in-Green, which uses surface pressure tanks. Both require a pump to move lake water through a cone or container with the oxygen flowing in the opposite direction to ensure high transfer efficiency. All bubble-free HOS are relatively small. The Blue-in-Green system would require more space on the shoreline compared to a Speece Cone system but removes the possible need for installing a submerged pump. However, so far the Blue-in-Green system, though finding applications in wastewater treatment, has not overcome bottom water heating as it passes through the shore-based system. In contrast, the Speece Cone system is all located in the deepest water and causes no temperature increase. The low temperature ensures that the oxygenated plume “hugs” the bottom sediments where oxygenation is most needed.

If the HOS purpose is a general improvement in fish habitat and some improvement in water quality, then a pure-oxygen bubble plume is often appropriate. Long reaches of pipe with hose with small holes provides the bubble plumes. Bubble plumes move upwards and, with reducing density (oxygen transfers out of bubble as it is absorbed in surrounding water), the bubbles’ diameter decreases and they rise much more slowly, tending to hover somewhat above the bottom. Although oxygen does reach the bottom, the system efficiency could be enhanced with a horizontal plume where the oxygen has dissolved. Commercial firms who offer such HOS bubble plumes (as installed in several San Francisco Area East Bay reservoirs) include Mobley Engineering.

For Lake Hodges, where water quality and reducing anoxia on the reservoir bed are paramount, a horizontal, highly oxygenated plume is most desirable. Therefore, a HOS using a Speece Cone or similar device is preferable. It should be located in the reservoir’s deepest part near the dam and be designed to produce a horizontal, highly oxygenated plume with a small manifold or larger jet pipes that would discharge close to the bottom. The plume height and its original depth should take into account the reservoirs bathymetry so that the plume minimizes low oxygen areas. See Figure 3-1 for a schematic diagram of the Speece Cone system.

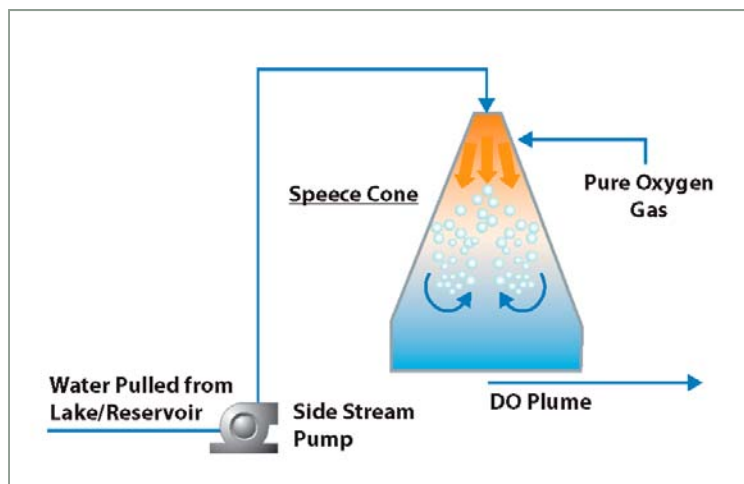

Figure 3-1. Schematic Diagram of Speece Cone System

3.4.2 VEM with Algae Scum Corraling

The VEM has been applied to address water quality issues for many years. Originally designed to reduce scums of BGA in shallow ornamental lakes in cities, including the royal lakes in Buckingham Palace, London, the concept was expanded in 2009 to the 850-acre Cherry Creek Reservoir near Denver, Colorado. The method is suitable to reduce the nuisance scums of BGA but may not reduce algae overall or even the percent of non-scumming (single filament) BGA. However, from the recreationist or lake user viewpoint, the

difference is large and desirable. In addition, the toxicity risk to people or dogs from BGA by ingesting scums is reduced.

Although described as vigorous, that is only from the algae's viewpoint; lake users would barely perceive a difference. BGA are very successful in warm stratified lakes since they can regulate their buoyancy daily and thus move from high to optimum light levels and even migrate down to deeper water at night where nutrients are more abundant. Buoyancy regulation for BGA, whose largest colonies are the size of a small pea, is ineffective when the water is mixing vertically faster than they can rise or sink, about 0.1 centimeters per second at best. Heavy diatoms dominate cool windy waters and can grow faster than blue-greens. Only when the water is warm and calm (diatoms sink out), do blue-greens prosper. Thus, artificial mixing of the upper waters (epilimnion layer) tips the balance away from scumming BGA.

For Lake Hodges, an array of VEM diffusers located near the lake bed in the shallow, un-stratified areas of the reservoir would reduce scumming blue-greens. The most important of these areas would be near recreational areas and the new mixing area where the pump storage water is exchanged.

3.4.3 Algae Corraling

It is proposed to remove nuisance scum algae directly via filtration through a Unit Process Wetland (UPW) constructed near the reservoir's upper reaches. As discussed in Section 2, historical remote sensing data has determined the sites where the nuisance BGA have formed surface scums in the past. A surface skimmer pump station will then suck up the algae and pass them to the wetland in a low headloss pipe. The integration of VEM and algae removal has not been attempted previously, though various systems have shown the method's validity. When the VEM is operating, a ring of algae will form around the edge of the rising bubble plume. It is expected that the VEM can be designed to move some of the surface scums towards historical areas of accumulation (corrals) where the algae skimmers can be located.

Removing unconcentrated phytoplankton in lakes and reservoirs normally is a difficult proposition since, even in eutrophic lakes, they are present at very dilute concentrations (<0.05 percent wet solids) relative to typical floating material found in wastewater treatment plants or mining (>6.0 percent or higher). However, some algae, especially BGA, float naturally and thus concentrate 1,000 or more times making removal efficiency higher for scums. If the natural historic scumming is combined with VEM direction (possibly with floating booms), then the new system could remove a substantial part of the nuisance. Remote sensing has shown variations in the spatial concentration of BGA in Lake Hodges but no special regular loci. However, the few monthly records available for past years are not frequent enough to determine if such loci exist as daily events as is common in many eutrophic lakes. Floating booms in these shallow upper areas would be a flexible and inexpensive way to corral the already 1,000 times concentrated surface BGA to the skimmers.

3.4.4 Wetlands Filters for Algae and Other Pollutants

Just as a few methods of in-lake management such as HOS, alum applications and dredging have proven to be good ideas, the use of constructed treatment wetlands is probably the best idea for watershed water quality improvement since detention ponds. Wetlands have long been used for pollution removal; more recently UPW have proven more efficient and reliable. For Lake Hodges, algae are the most pressing problem. It is possible to design a short water residence time wetland that will remove almost all algae from water passed through the wetland. The concept has long been known but was pioneered in the modern era by Florida where large-scale wetlands of over 4,000 acres are used to remove particulate-P from the outflow of Lake Apopka. This wetland also removes algae particles too since almost all macrophyte-dominated wetlands remove algae even if not specifically designed for that purpose.

For Lake Hodges, a new skimming and pumping system collect a stream of naturally concentrated and VEM-concentrated blue-green scums from the lake surface (see above) and passed to the wetland via low head

pumps and pipes. It is estimated that a wetland with only a 2-day hydraulic residence time would remove most algae. The BGA will be physically trapped in the thickets of emergent plant stems and sink out or be filtered by the mass of microorganisms present as the biofilm on the stems of the wetland plants. Although few lake organisms eat BGA, attached species of rotifers are so abundant in some wetlands that they may play an important role in filtration. Prior to the removal of many shoreline wetlands, filtration through natural wetlands was probably the main mechanism that kept eutrophic lakes relatively free of algae scums.

The choice of plants is important; therefore, the City would consult appropriate specialists during design to provide a robust mix of hearty plants. Native plants shall be emphasized to the extent practical, but they would need to grow to about 6 feet high. However, for other pollutants, additional species would be desirable as discussed further below.

3.4.5 Removal of Other Pollutants in Summer Urban Runoff and Winter Storms Flows

An increasing number of watershed best management practices in urban areas use some form of wetlands in association with detention ponds. For Lake Hodges, it should be straightforward, using the UPW technology, to remove nitrates, heavy metals and even exotic organic compounds (for example, pesticides or the polycyclic aromatic hydrocarbons that are found in urban runoff due to drips of car crankcase oil). The final design will depend on the volumes and pollution loads. Orange County and Irvine Ranch Water Districts have pioneered some of the better UPW over the last 20 years but other areas now use the methods. At Lake Hodges, the proposed algae filtering wetlands (see above) could be adapted for removal of other pollutants by increasing the water residence time to about a week or two and adding a different plant mix. A mix of mainly cattails (*Typha*) which provide the best energy source for the desired microbial pollution transformation, some bulrush and some shallow water periphyton wetlands is a likely choice for the multiple needs of Lake Hodges and surrounding urban areas.

3.4.6 Lake Hodges Natural Treatment Systems Study

While managing or treating incoming sources of pollutant loadings to Lake Hodges is not this study's objective, other plans for water quality improvements in this area were reviewed to assess the potential for coordinating or integrating projects planned on the east side of the lake. Two studies prepared by Dudek & Associates were reviewed. These studies, available in Appendix H, include the "BMP Comparison Memorandum" (September 2013) and "Nutrient Loading and Natural Treatment System Location Memorandum" (November 2013). These memoranda assess nutrient loading into Lake Hodges and develop initial options for a series of detention basins and constructed wetlands.

The proposed wetlands filter for algae and other pollutants (Section 3.4.4) should be evaluated for its potential to include diverting urban runoff from adjacent storm drain systems into the wetlands. The wetlands system will provide for treatment to remove nutrients and metals. Another component to consider for the wetlands includes the passive recreational opportunities and habitat benefits. Section 7 of this report provides a recommended study to integrate the wetlands to also treat the dry weather urban runoff and the nutrients that are conveyed to the Lake Hodges reservoir.

3.4.7 Biomanipulation

Humans have used this concept, manipulating the ecosystem to prefer some organisms over others, since the origin of cultivation 10,000 years ago. As applied to the reduction of nuisance algae lakes, the concept was first used in the 1950s in Hungary. Over time the technique has been refined and now has three main components:

1. The biomass of large Daphnia zooplankton is enhanced since these animals graze larger amounts of algae than almost any other group. To avoid fish, which are sight predators, Daphnia graze at night but must find a refuge in deep oxygenated water or among vegetation.
2. Small fish are reduced since they preferentially eat large Daphnia. This removal is usually accomplished either by adding larger fish to eat the small ones or by netting out excess small ones after the spring hatching period.
3. Submerged aquatic vegetation (SAV), especially leafy aquatic plants, are encouraged since they provide hiding places for large Daphnia during the day when fish can see and eat them. In addition, periphyton that grow on SAV compete successfully with nuisance phytoplankton, including BGA. Also SAV roots stabilize the shallow water sediments reducing turbidity and nutrient recycling caused by wave action. Removal of large bottom-grubbing fish such as carp decreases nutrient recycling.

Although biomanipulation seems too good to be true, at least 16 examples exist where long-term (10 years) of biomanipulation has resulted in large increases in water quality and reduction of nuisance algae. Much of the benefit has been found for shallow lakes ($Z \sim 1$ to 4 meters [m]); however, there are large areas of Lake Hodges within this range. In addition, the fishery is usually improved since management practices encourage larger fish more prized by anglers.

Enhancement of large Daphnia may occur, since large Daphnia will find a dark, oxygenated refuge from fish predation below the thermocline during the day and then surface at night to feed on algae. Most fish are sight feeders and cannot find Daphnia in the dark. Adding additional Daphnia to the reservoir is not a recommended manipulation since small fish would find and eat the added Daphnia. The City could add floating wetlands on an experimental basis to test both technical feasibility and potential biological benefits.

The large water level fluctuations and low water clarity in Lake Hodges preclude the development of rooted emergent of SAV. However, a new kind of floating wetland that would be moored offshore may provide a good method to introduce leafy pondweeds such a submerged Potamogetons. Anchored 5 feet down the SAV would provide a good site for Daphnia to hide and periphyton to grow. In terms of impact, it may be good to pair the submerged floating wetlands with emergent wetlands that have some value in providing visual beauty in the recreational areas. The dense root system of emergent floating wetlands also provides habitat and refuges for large Daphnia.

However, it should be noted that floating wetlands have not been shown to reduce nutrients or pollution in realistic tests. They do provide habitat for birds and look nice in reservoirs that have a fluctuating water level but do not provide any (or very little) pollution or nutrient removal. It is possible, but not shown, that large floating wetlands that are harvested regularly could remove some nutrients but the amount would be small since plants have only about 1 percent N and 0.1 percent P in their wet biomass, thus, mass balance is not favorable. In addition, harvesting from floating wetlands is difficult and has not been attempted on a workable scale.

3.4.8 Algaecides/Molluscides

Algaecides. The State of California Water Resources Control Boards adopted the Statewide General National Pollutant Discharge Elimination System (NPDES) Permit for Residual Aquatic Pesticide Discharges to Waters of the United States from Algae and Aquatic Weed Control Applications, Water Quality Order 2013-0002-DWQ, which became effective on December 1, 2013.

This General Permit covers only discharges of algaecides, and aquatic herbicides that are currently registered for use in California, or that become registered for use and contain the active ingredients and ingredients represented by the surrogate of nonylphenol. These products, primarily short-lived peroxides or similar compounds such as PAC27, work but are expensive. It is recommended for Lake Hodges reservoir that the City reserve algaecide use for emergencies when in-lake and in-water treatment plant methods (granular activated carbon, ozonation and permanganate) are overwhelmed.

Molluscides and other Quagga Treatments. Section 5 and Exhibit C provide a discussion of issues and potential control measures for Quagga mussels.

3.5 Water Quality Modeling

To evaluate the performance of the proposed alternatives, a water quality model was developed. The need for modeling arises from the unique and complex characteristics of Hodges, manifested by severe anoxia and episodes of low DO in the entire water column, significant nutrient recycling, pump back operation, and high levels of algae.

A one-dimensional water quality model, DYRESM-WQ, was used for this effort. This model provides the necessary level of accuracy and detail to develop a practical simulation tool that can be used to test alternative operational scenarios.

The water quality modeling results were used as desktop confirmation (see Appendix E for details).

3.5.1 Data Analysis

The team gathered various inflow, outflow and in-reservoir water quality data from the City and other entities for the period January 2008 to October 2013. The City collects near-weekly profiles of various water quality parameters at Station B, located near the Pump Storage Project (PSP). The City also collects runoff water quality data. The Santa Fe Irrigation District (SFID) operates an automated water quality profiler located near the dam (SFID Profiler). Figure 3-2 shows the water quality stations, Station B and the SFID Profiler.

Lake Hodges stratifies similar to many other relatively-deep reservoirs in southern California. The thermocline is established at an approximate depth of 5 to 10 m in the summer. In the late fall, the thermocline deepens rapidly until turnover is achieved. From the spring to fall, the epilimnion features near-saturation levels of DO while the hypolimnion shows DO levels near zero. After turnover, and for a few weeks thereafter, DO levels within the entire water column are observed to be well under full saturation. In some instances, data show total DO depletion in the entire water column at Station B. This phenomenon is not observed in most water supply reservoirs operated by the City. Chlorophyll a concentrations in the 50 to 100 micrograms per liter range are observed. Secchi depth values are typically less than 1 m for the majority of the time.

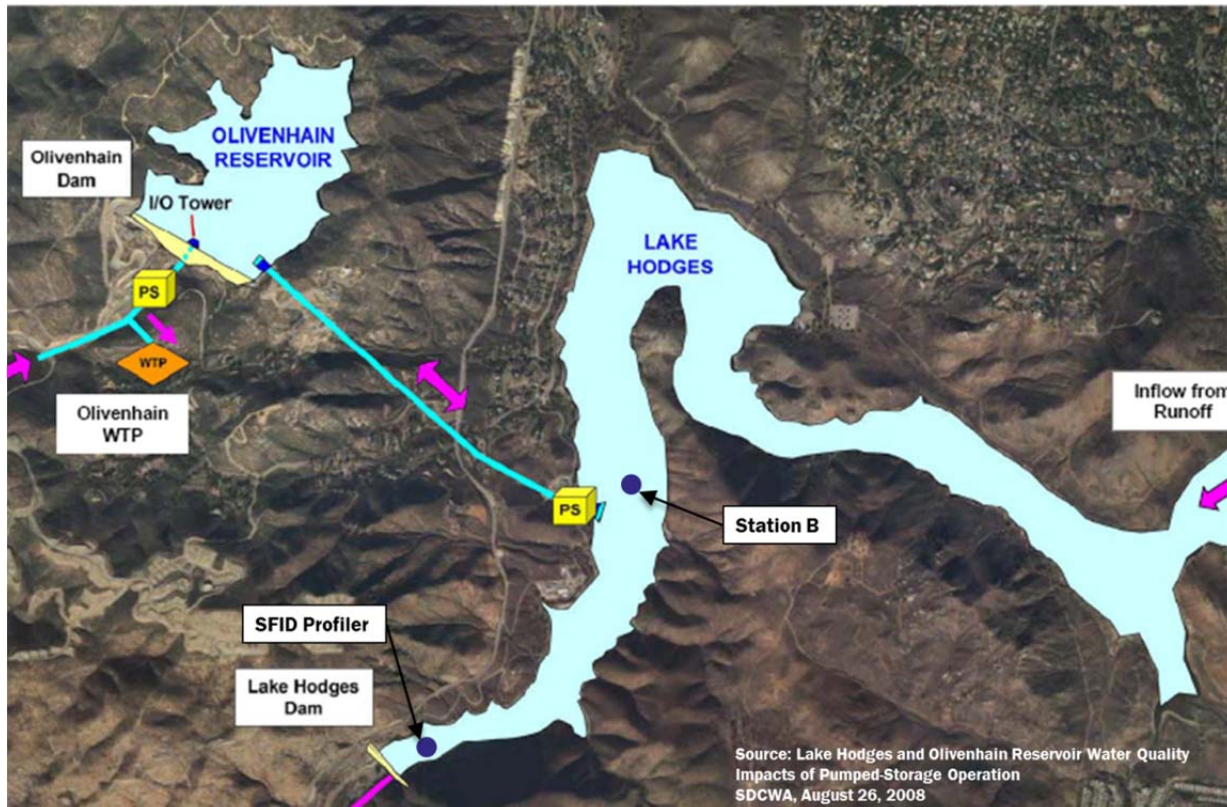

Figure 3-3. Lake Hodges Reservoir showing the Pump Station and the Water Quality Monitoring Stations

3.5.2 Model Description and Calibration

The one-dimensional water quality model DYRESM/CAEDYM was used to analyze the reservoir. DYRESM/CAEDYM assumes that the reservoir is horizontally homogeneous and computes the vertical variations in temperature, salinity, and other water quality variables. Description of the algorithms and methodologies for DYRESM/CAEDYM can be found at <http://www.cwr.uwa.edu.au/software1/models1.php?mdid=2>. The model calibration period extended from January 1, 2012, to October 20, 2013.

Simulated temperature and DO contours compare well with observed data. In the calibration, the sediment oxygen demand (SOD) rates that produce the closest agreement to the observed data in the overturn period are in the range of 3 to 6 grams per square meter per day (g/sm-d). It is also noted that since DO levels in the hypolimnion rarely rise above zero, it is not possible to calculate the SOD rate accurately. Since oxygen demand, which is strongly influenced by SOD rate, is important for sizing an HOS system, it is strongly recommended that sediment core DO demand investigations be conducted such as those done for the San Vicente Reservoir (SVR) in 2001 by Dr. Mark Beutel. The 2001 investigations determined SOD rates of 0.1 to 1.7 g/sm-d. It is noted that the SVR is significantly less productive than Lake Hodges.

3.6 Summary

This section has presented, developed and evaluated available, commonly applied approaches and technologies for improving reservoir water quality, especially for algae control. Through the initial workshop and subsequent analyses, the BC team developed a combination of approaches that the agencies could implement in phases, both to manage available funding and to assess the effectiveness of successive phases as presented (in order of priority) as follows:

1. HOS using a Speece Cone
2. VEM
3. Wetland filters for Algae corralling
4. Biomanipulation
5. Algaecides/herbicides/molluscicides (and other Quagga mussel controls)

Section 4

Recommended Alternative

This section provides more detail about the recommended alternative initially described in Section 3.

4.1 Facility Siting for Lake Management Alternative

4.1.1 Criteria for Facility Siting

On July 2, 2013, the project team visited potential sites around Lake Hodges to select the best area for each alternative component. Key consideration included site access for both construction and ongoing operation and maintenance, proximity to the in-lake location for facilities, and availability of power service for equipment operation. Figure 4-1, below provides a location map of locates those sites. Table 4-1 presents key site considerations.

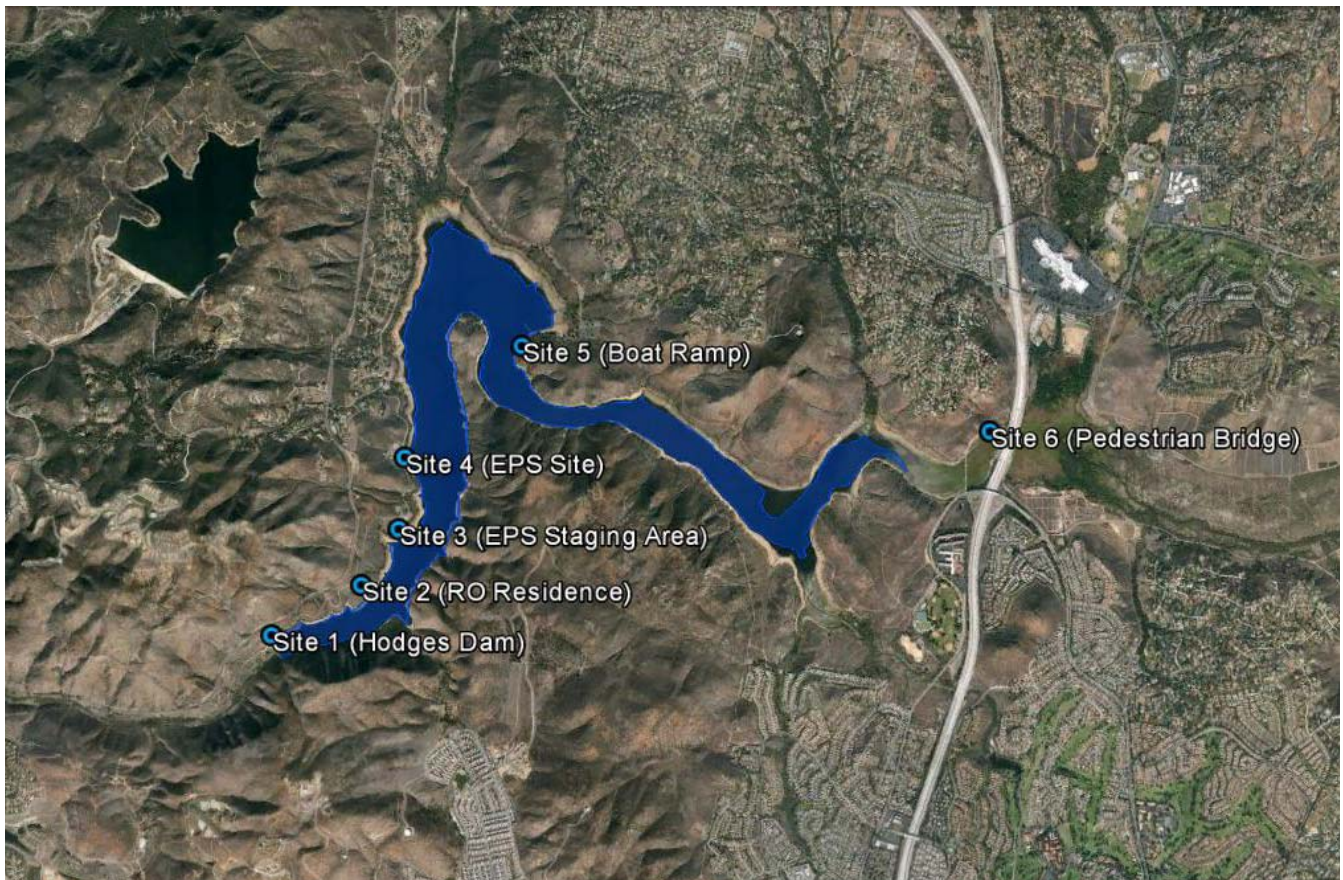

Figure 4-1. Location Map of Site Visit (July 2, 2013)

Table 4-1. Lake Hodges Siting Summary

Site	Location	Description	Access	Power
1	Hodges Dam	Northside near spillway and access road	Accessible with narrow unpaved access road. Existing gauging station structure above spillway level	3-Phase Power
2	Former Reservoir Operator Residence	Operator Residence structure and storage facility	Accessible with graded access road, gate, and existing house and storage structure	Single Phase Power
3	PSP Construction Staging Area	Graded area used for staging materials for the PSP construction project	Accessible with access road and turnouts	No Power Supply
4	Emergency Pump Storage Site	Available areas near the PSP Facility	Accessible with paved road	3-Phase Power
5	Boat Ramp Area	Recreation area and boat ramp	Accessible with paved road and boat ramps	Single Phase Power
6	Pedestrian Bridge	Pedestrian Bridge over the Lake Hodges area west of the I-15 bridge	Accessible with access roads and pedestrian bridge across the lake	Single Phase Power

4.1.2 Site Visit Location Summary

The following is a description of the sites visited for lake management components. Table 4-1 provides a summary of the sites visited by the project team.

Site 1 (Lake Hodge Dam).- Site 1 is very near to Hodges Dam where the City could install the HOS in a site protected from boat access by a boom and exclusion zone. High-voltage three-phase power is immediately available as is a partially graded site close to the water's edge where the City previously operated an air compressor facility. Therefore, Site 1 was considered for further evaluation (see Figure 4-2).

Site 2 (Reservoir Operator Residence). Although the site is spacious and has relatively easy access, Site 2 (Figure 4-3), located at the former reservoir operator's residence, is well removed from the dam and only has single-phase power currently available. Installing the HOS at Site 2 would require installing over 2,000 feet of electrical cable and 2,000 feet of oxygen pipeline. Therefore, Site 2 was not considered for further development.

Site 3 (PSP Staging Area). Site 3 is located at the construction staging area used for the Emergency Pump Storage Project (Figure 4-4). This site also is referred to as the wind-surfer's site. It has good access but no existing power service. Owing to distance from the dam and lack of power, Site 3 was not considered for further development.

Site 4 (PSP Site). Site 4 is located at the Emergency Pump Storage Facility has good access to deliver materials and install equipment (Figure 4-5). While this site has sufficient space and three-phase power service, it is well over a mile from deeper water near the dam. Therefore, Site 4 was not considered for further development.



Figure 4-2. Lake Hodges Dam Area, Site 1



Figure 4-3. Former Reservoir Operator Residence and Storage Facility Area, Site 2



Figure 4-4. Former PSP Staging Area, Site 3

Site 5 (Boat Ramp Area). Site 5, located mid-lake at the Boat Ramp area, has good access for boating and potential for lake treatment facilities. Single-phase power is also available near this area. This site is located away from the dam, near the recreation area. Therefore, Site 5 was not considered for an HOS facility but will be considered for supplemental Lake Management alternatives.

Site 6, Pedestrian Bridge. Site 6 is located west of Interstate 15 and has a graded access road on the north side and street access to the south side (Figure 4-6). Single-phase power is also available to the south side and could be made available to the north side of the bridge.

Refer back to Table 4-1 for a summary of the access and availability of power for each site visited.

4.1.3 Requirements for System Components

The project team developed a recommended strategy for lake management, with potential implementation areas shown in Figure 4-7 below. The following discusses the siting requirements of these components within the Lake Hodges Reservoir area.



Figure 4-5. Emergency Pump Storage Area, Site 4



Figure 4-6. Lake Hodges Pedestrian Bridge, Site 6

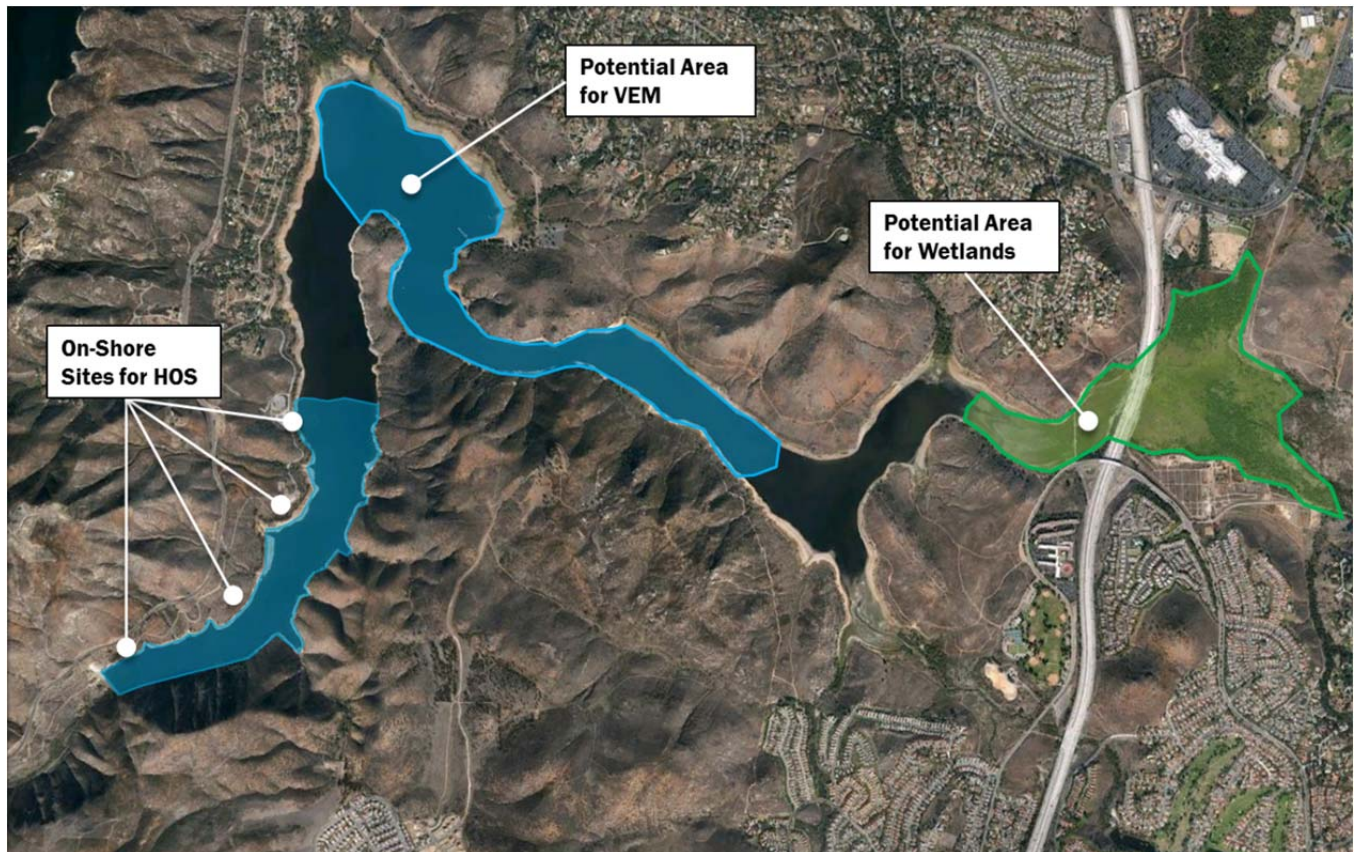

Figure 4-7. Overview of Recommended Lake Management Alternatives

HOS. For the HOS to work most effectively, the Speece Cone must be located at or near to the reservoir's deepest water. The team explored Sites 1, 2, 3 and 4 to determine which location would be best for the HOS. Review of all potential sites, as well as a review of adjacent roadways and neighborhoods, showed that truck delivery of liquid oxygen would be neither feasible nor acceptable to neighbors. Therefore, we discarded liquid oxygen delivery and adopted on-site oxygen generation as part of any alternative. The team determined that Site 1 at the dam area provides adequate power supply and vicinity to the lowest elevation of the reservoir. Road access is suitable for both construction and ongoing maintenance. The site is partially graded but would require additional grading for a new building to house the oxygen production and associated electrical and control equipment.

VEM. The VEM would help prevent BGA scumming in the reservoirs shallower water. It would produce the most benefit located along the north shoreline, especially near the recreation area boat ramp. The facility would require an onshore building with power service for the air compressor equipment. Dr. Horne recommended locating the offshore area for the test VEM system in the area shown in Figure 4-7. The team identified Site 5 as a good location for the onshore equipment because of easy site access and electric power availability. During subsequent review with agencies representatives, the City suggested that the sewage lift station located northwest from the boat launch area would be a better location.

Algae Corraling and Wetlands. Based on a preliminary review of data presented in the Blue Water Satellite Technical Report (Appendix I), it appears that a good location for a surface skimming intake would be at the mouth of the large cove west and slightly north of the tennis courts located west of West Bernardo Drive (see Site 6 on Figure 4-6). Road access would be over trails that split off from West Bernardo Drive. The power supply for the skimming pumps would come along the same route through buried high voltage conduit. The most attractive wetland site would be in shallow water along the north shoreline, west of the Interstate 15 bridge.

4.2 Lake Hodges Reservoir Project Concept

Working closely with agency staff, the BC team identified and evaluated several potential alternatives to improve Lake Hodges water by decreasing algae production while addressing non-attainment issues. BC has combined the alternatives into an overall plan with several key components, as follows.

4.2.1 Reservoir HOS

The HOS adds pure or nearly pure oxygen gas into deep hypolimnion of lakes and reservoirs. To estimate potential oxygen demands, the project team reviewed and used oxygen profile data. Such estimates are difficult now for Lake Hodges since its operational regime will change as the pump-storage facilities is brought to full capacity and regular operation. For data covering a 2-year period ending in the fall of 2013, the only profile data that showed marked hypolimnion oxygen decrease was for a period from mid-February through mid-March 2013. The water surface elevation over that period was at about elevation 294, with the hypolimnion starting about 26 feet below the surface and a hypolimnion volume of about 2,500 AF. The calculated hypolimnion water column demand was about 0.2 grams per cubic meter per day (g/cm-d). This value is a relatively high value for reservoir water and probably reflects high algae productivity during a relatively warm winter with little rainfall or cloud cover. BC did not carry out any sediment oxygen demand (SOD) measurements since these require extensive laboratory work that was beyond this preliminary evaluation. Based on literature information, the SOD was set at 0.2 g/sm-d, a conservatively high value.

The oxygen demand for two conditions was then projected; lake surface at elevation 290 (typical operation with pump-storage facility operating) and elevation 315 (reservoir full every 5 to 10 years, with short duration for full operation). For the former case, a HOS of 0.2 g/cm-d was used with an SOD of 0.2 g/sm-d,

arriving at a daily demand of about 1.0 tons per day (tpd). For the later case, a HOS of 0.12 g/cm-d and a SOD of 0.2 g/sm-d was used, arriving at a daily demand of about 3.1 tpd.

The lower HOS was used since the condition would occur infrequent and would have a short duration. This approach avoids installing a larger system that would be used infrequently if at all at its full capacity, while still providing considerable oxygen supply.

A single speece cone is recommended to meet the daily oxygen demand of 1.0 tpd. Also, if the daily oxygen demand is increased, the single speece cone could be increased in size. The location of the speece cone should be placed for maximum operational depth and greatest efficiency. The optimal location in the reservoir for this component is near the dam.

For Lake Hodges, major HOS components would include (see Figure 4-8):

- Concrete masonry unit onshore building (see Appendix A for preliminary floor plan) with fire resistant roof.
- A 600-ampere main electrical service with components and capacity to support all HOS equipment (see Appendix A for preliminary panel front layout).
- Three ESA oxygen generation units with a capacity of about 1 tpd each.
- Programmable logic controller connected to the City's supervisory control and data acquisition (SCADA) system.
- Skid-mounted Speece Cone (See Figure 4-8) with approximate dimensions as shown in Appendix A.
- Intake screen, connecting piping, and discharge manifold/diffuser mounted on the Speece Cone skid.
- Submersible pump (75-horsepower name plate).
- Power cable and oxygen pipeline connecting the shoreline facilities to the Speece Cone and pump as shown in Appendix A.



Figure 4-8. Speece Cone for in-lake installation and diffusers

4.2.2 Mid-Lake VEM

The VEM system is designed to reduce scums of BGA in shallow water. VEM provides sufficient surface dispersion and reduction of the nuisance scums of BGA. Based on criteria provide by Dr. Alex Horne, it would include three rows of circular membrane diffusers located at water depths of 8, 16 and 24 feet below a reservoir water surface elevation of 290. The air flow per diffuser should be about 2.5 cubic feet per minute (cfm). Dr. Horne recommends spacing the diffusers horizontally at about 10 time water depth. Appendix A provides a VEM schematic.

Major VEM components include (See Figure 4-9):

- Concrete masonry unit onshore building ((see Appendix A for preliminary floor plan)) with fire resistant roof.
- A 600-ampere main electrical service with components and capacity to support all VEM equipment (see Appendix A for preliminary panel front layout).
- Two low pressure compressors, each capable of producing about 180 cfm.
- Air receivers to cool compressed air and prevent surging.
- An air manifold in the compressor building including flow metering, pressure regulators and valving.
- Programmable logic controller connected to the City's SCADA system.

- Three submerged manifolds with membrane diffuser (total of 76).
- Each diffuser row would be about 3,000 feet long. A new fire-resistant building near the existing sewage lift station would house the onshore equipment.

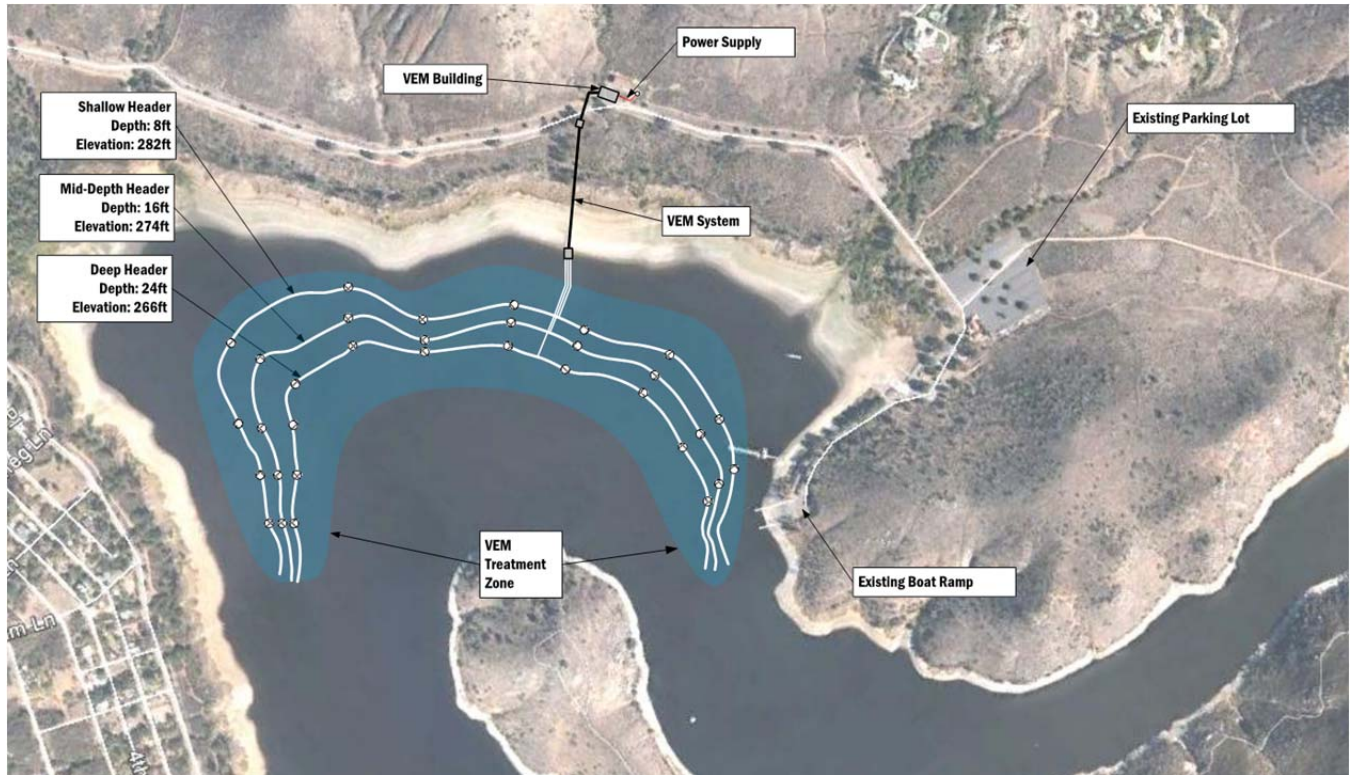

Figure 4-9. Conceptual Layout of Proposed Mid-Lake VEM System Near Boating Area

4.2.3 Upper Wetlands - Algae Corraling and Wetlands Filters

As discussed in Section 3, constructed treatment wetlands are useful for improving reservoir water quality, by filtering out algae.

The proposed constructed wetland (See Figure 4-10) would include:

- Floating pump station with algae-skimming intake, two vertical turbine pumps, and associated piping, with capacity to pump about 8 mgd.
- Onshore electrical and SCADA equipment to support the floating intake and pump station (see Appendix A for preliminary panel front layout). A walk-in NEMA 3R cabinet would house the electrical equipment.
- Submerged, bottom-laid, 24-inch-internal-diameter discharge pipeline, connecting the intake at Site 7 to the upstream wetland end.
- About 25 acres of wetlands constructed in a 30-acre site, in the reservoir's shallower water along the north shoreline west of the Interstate 15 bridge. The wetlands would be divided into about 36 cells, each about 300 feet long by 100 feet wide. The upstream end of each cell would have an open water area to ensure even water distribution across the cell. Planting would be bulrush for best filtering capacity. A return pipeline would convey water from the downstream cell to the reservoir. Gravel roadways would surround the cells, to allow access for cleaning and maintenance.



Figure 4-10. Conceptual Design Layout of Wetlands

4.2.4 Coordination with the Lake Hodges Natural Treatment Systems Study

As currently planned, the Lake Hodges Natural Treatment System Options for detention basins and constructed wetlands would not conflict directly with any of the proposed algae filtering wetlands recommended in this report (Appendix H).

However, this study’s proposed Upper Wetlands could be integrated with the Lake Hodges Natural Treatment System (detention basin or constructed wetlands) into a multi-purpose and multi-benefit wetland area along the east part of the lake to include summer algae scum filtration, dry-weather urban runoff (from storm drains). The addition passive recreational opportunities, native landscaping, and educational signage should be included into the wetland design.

Benefits of Integrated Facilities. This approach would offer the following potential benefits:

- Integration with lake-specific treatment systems with Municipal Separate Storm Sewer System (MS4) needs may provide improved economy of scale through a larger regional project.
- The MS4 planning (through the Water Quality Improvement Planning Process) is currently very active; therefore, timing would be appropriate.
- Multi-purpose, multi-benefit, regional facilities have proven to be appealing targets for grant funding and have typically gained broader stakeholder support.

Challenges of Integrated Facilities. Potential challenges with this approach include:

- Broader agency support and endorsements would be required.
- Additional permitting and regulatory needs would be likely.
- Additional stakeholder support may be required.

4.3 Estimated Effectiveness of Recommended Alternative

4.3.1 Water Quality Model Analysis - Dynamic Reservoir Simulation Model

To evaluate the performance of the proposed alternatives, a water quality model was developed. Appendix E provides the Water Quality Model Analysis.

The need for modeling arises from the unique and complex characteristics of Lake Hodges, manifested by severe anoxia and episodes of low DO in the entire water column, significant nutrient recycling, pump back operation, and high levels of algae.

A one-dimensional water quality model, DYRESM-WQ, was used for this study. This model provides the necessary level of accuracy and detail to develop a practical simulation tool that can be used to test alternative operational scenarios. The model was used to help determine the appropriate DO loading rate from aeration devices (HOS and VEM).

4.3.2 Model Results

After the calibration was completed, 10 “what-if” simulations were performed to assess lake water quality under various hypothetical scenarios. Table 4-2 shows the 10 simulations. The simulations included model runs at different water surface elevations (WSEL), different SOD rates, different HOS injection rates, as well as different depths for oxygen injection. Some model runs were performed to simulate VEM.

The following text presents highlights of the results of specific model runs. It is noted that the results of the model runs are highly dependent on various assumptions about SOD and future lake operations, including WSEL and PS operations.

Table 4-2. List of Simulations

Run #	WSEL (ft)	SOD g/sm-d	HOS Input lbs O ₂ /day	Oxygen Injection Level #levels/ft above bottom	VEM Input lbs O ₂ /day
1	2012/2013	3.0	661	1 level (10 ft above bottom)	No VEM
2	2012/2013	3.0	1,323	1 level (10 ft above bottom)	No VEM
3	2012/2013	3.0	6,834	3 levels (10 ft, 25 ft, & 40 ft above bottom)	No VEM
4	2012/2013	3.0	13,889	3 levels (10 ft, 25 ft, & 40 ft above bottom)	No VEM
5	2012/2013	3.0	6,834	5 levels (10 ft, 25 ft, & 40 ft above bottom)	No VEM
6	2012/2013	6.0	6,834	5 levels (10 ft, 25 ft, & 40 ft above bottom)	No VEM
7	Fixed @ 315 ft	3.0	9,800	2 levels (6.6 ft, & 20 ft above bottom)	3,300
8	Fixed @ 315 ft	1.5	9,800	2 levels (6.6 ft, & 20 ft above bottom)	3,300
9	Fixed @ 290 ft	3.0	7,600	2 levels (6.6 ft, & 20 ft above bottom)	2,200
10	Fixed @ 290 ft	1.5	7,600	2 levels (6.6 ft, & 20 ft above bottom)	2,200

4.3.3 Recommendations

The modeling results are largely dependent on the sediment oxygen demand rate, ranging from 1.5 to 6 (in g/sm-d). For example, for model run 7, the hypolimnion is well oxygenated but near-zero DO values are observed. For model run 8 (SOD = 1.5), the DO levels increase substantially, indicating a well oxygenated reservoir.

As a result of this uncertainty, the project team recommends sediment core characterization is conducted to measure the SOD rate. The SOD rate will be a controlling criteria in the design of the HOS system.

Section 5

Quagga Mussel Control Issues

This section presents a review of Quagga mussels, the environmental conditions required for their growth, and the potential consequences of improving water quality in Lake Hodges Reservoir as it might affect Quagga mussels establishment and long-term survival. We also discuss some potential control mechanisms should Quagga mussels become established. The issues discussed and the recommendations provided in this section are addressed in more detail in Appendix C.

5.1 Environmental Requirements and Projected Changes

For two important parameters, water temperature and calcium concentration, Lake Hodges appears to be fully suitable for Quagga mussels. However, other parameters—low DO and pH and high nutrient and algal concentrations—could be limiting during part of the year at certain depths. Some of these conditions are expected to improve as a result of the recommended lake management projects, so that Lake Hodges would become more vulnerable to colonization by Quagga mussels.

Quagga mussels are believed to need at least 2-4 milligram per liter of DO (Cohen 2007, 2008a). When the lake is stratified, DO can be at or near zero in the hypolimnion, though epilimnetic values remain suitable for Quagga mussels (Jones & Stokes 2007; RNT 2011). The proposed HOS should improve conditions for Quagga mussels in the reservoir's deeper water.

Quagga mussels are believed to require a pH of at least 7.3 or 7.4 (Cohen 2007, 2008a). The pH levels in Lake Hodges' hypolimnion are usually between around 7.1 and 7.9 (Jones & Stokes 2007) and at times could be limiting for Quagga mussels.

Various studies have shown that zebra mussels do poorly in lakes with high concentrations of nutrients or algae (Cohen 2005). Quagga mussels are believed to have a similar response, and high algal concentrations in the surface waters of Lake Hodges could be limiting during some seasons (RNT 2011). Several of the recommended lake management projects are intended to reduce algal concentrations, including Vigorous Epilimnetic Mixing and the Filtering Wetland and, thereby, could improve conditions for Quagga mussels.

The proposal to harvest carp and smaller food fishes could have either a positive or negative effect on Quagga mussels, depending on how the removal of these fish affected the populations of other fish or birds in the lake, and on the Quagga mussel-consuming habits of the different fish and bird species. It would be challenging to quantify the net impact, but it seems unlikely that it would be large.

5.2 Status of Quagga Mussels in Lake Hodges and Potential for Introduction

No adult Quagga mussels have been found in Lake Hodges, and although two positive tests for Quagga mussels in plankton samples have been reported, in our view we see no significant evidence that Quagga mussels are established in the lake (see discussion in Appendix C). We have identified two main mechanisms by which Quagga mussels could arrive: either carried as larvae through the Olivenhain-Hodges Pipeline, or transported overland on trailered boats. The history of zebra and Quagga mussel spread shows that transport through waterways is a much more effective dispersal mechanism than overland transport, as

one would expect. If larvae are carried alive through the pipeline from Lake Olivenhain, then this condition likely poses the greater risk to Lake Hodges.

Several studies have shown that bivalve larvae, including zebra mussels, can be killed by turbulence. SCDWA had engineering calculations done that concluded that all Quagga mussel larvae would be killed by the turbulence generated during passage through the turbines in the pump/generation facility (SDCWA 2010). Our limited review suggests that this conclusion should be viewed with caution (see Appendix C).

The SDCWA Dreissenid Mussel Response and Control Plan, dated December 2010, was reviewed with the California Department of Fish and Game. Based on their review of this plan, it was determined that the SDCWA had incorporated sufficient control mechanisms in the system to contain the mussels (See Appendix D).

Regarding overland transport, the City currently inspects boats for Quagga mussels before they are launched on Lake Hodges (RNT 2011; City of San Diego). Nevertheless, boats remain a viable mechanism for transporting Quaggas into the reservoirs.

5.3 State of Quagga Mussels in Lake Hodges

BC has identified several possible approaches for reducing or possibly removing a population of Quagga mussels if one became established in Lake Hodges, depending on the size and distribution of the population.

A small population with a restricted distribution could be treated by physical removal (used on zebra mussels in Lake George, New York, though under conditions that made it impossible to determine it was successful), covering with tarps (99 percent of zebra mussels killed in an experiment in Lake Saratoga, New York), or covering and treating with a biocide (used successfully on a non-native seaweed in southern California). If an invading population of Quagga mussels had a known and very limited distribution within Lake Hodges, eradication might be possible using these methods.

A population present only in shallow water might be eradicated (and would at least be greatly reduced) by drawing down the water level to expose the mussels to the air and allow them to desiccate. Laboratory and local climate data suggest that Quagga mussels could survive less than four to seven days of aerial exposure at Lake Hodges (see Appendix C). SDCWA has used this approach to control Quagga mussels in Lake Olivenhain.

A population present only in deeper water might be eradicated (and would at least be greatly reduced) by suspending hypolimnetic oxygenation temporarily (and probably also VEM) and allowing hypolimnetic oxygen to decline. Quagga mussels could probably survive anoxia in the hypolimnion for no more than a week or ten days, even during colder months (see Appendix C).

The City could reduce a widespread population by a combination of drawdown and hypolimnetic oxygen reduction. Metropolitan Water District of Southern California has used this combination in a reservoir for one month each summer to control Quagga mussels (SDCWA 2010). A widespread population also could be reduced or possibly eradicated by whole-lake treatment with a biocide. Potash (potassium chloride) treatment eradicated zebra mussels from a Virginia quarry pond (USFWS 2005; Aquatic Sciences 2006); copper sulfate treatment eradicated a related marine mussel from boat basins in Australia and greatly reduced zebra mussels in a Nebraska lake (Cohen 2008b). Other approaches include treatment with Zequanox®, a bacteria-derived biocide that is highly specific for Quagga and zebra mussels (Malloy 2005); and delivery of a biocide encased in an edible pellet, which narrowly targets delivery to the mussels and reduces risks to non-target organisms (Aldridge et al. 2006; Cohen 2008b).

In November 2013, the State of California has issued a Certificate of Pesticide Registration for Zequanox® to control invasive zebra and Quagga mussels (*Dreissena* species) in pipe systems and infrastructure. Under this registration, Zequanox can be used as an effective, environmentally responsible alternative to toxic, broad-spectrum chemicals (such as chlorine) to treat irrigation lines and water conveyance structures, as well as cooling and process water systems of industrial and power generation facilities.

A feasibility study of eradicating zebra mussels from San Justo Reservoir in California selected potash treatment as the preferred alternative (Cohen 2008b). Since the active ingredient remains in suspension for weeks, long exposure at a low dose is possible, which provides flexibility, certainty and low impacts. Water at full treatment strength would meet state and federal ambient and drinking water quality requirements, and have no harmful effect on other organisms except for bivalves (Cohen 2008b). The only other bivalve likely to be present in Lake Hodges is another non-native pest species. Whole-lake treatment is likely to be expensive, however. If drawn down to a surface elevation of 290 feet, direct scaling from the cost of the Virginia quarry pond treatment produces a rough estimate of \$4 million to treat Lake Hodges.

Although it would be theoretically possible to reduce a Quagga mussel population by increasing the populations of Quagga mussel-consuming fish or birds, such an approach never has been implemented and aside from the practical challenges involved, it is unclear how large a difference it would make. Recent testing conducted on use of mussel consuming birds or fish have not demonstrated the ability to change the mussel population.

5.4 Recommended Control Program for Lake Hodges Reservoir

As discussed above, the lake management projects will raise hypolimnetic oxygen levels, which are currently too low to support Quagga mussels. Because the outlet from the Olivenhain-Hodges Pipeline is in the hypolimnion, if larvae are carried alive through the pipeline, then low hypolimnetic oxygen may be the barrier that has prevented Lake Hodges from being colonized. If that is the case, then there is an urgent need for a more thorough assessment of actions that might prevent transport of mussels through the pipeline or that would respond to an invasion when one occurs. Such an approach would ensure that adequate monitoring, decision and response systems are in place before hypolimnetic oxygen concentrations are increased. If, on the other hand, mussels cannot reach Lake Hodges through the pipeline, then the City should focus more on managing the other main mechanism by which they could arrive, via trailered boats.

- **Recommendation 1.** First, review the calculations that found that no Quagga mussels will be transported alive through the pipeline (see Appendix C for details).
- **Recommendation 2.** If that conclusion appears valid, it should be tested by targeted sampling of the water flows through the tunnel (see Appendix C for details).
- **Recommendation 3.** If the calculations and sampling show that mussels can be transported alive through the pipeline, the City should assess possible actions to prevent such transport (see Appendix C for details).
- **Recommendation 4.** If mussel transport through the pipeline is possible and cannot be prevented, then the City should assess eradication/control thoroughly, and develop and implement monitoring, decision and response systems needed to ensure the timely implementation of appropriate responses. A possible response action may include temporarily terminating water transfers between Lake Hodges Reservoir and Olivenhain Reservoir in concert with eradication/control measures.
- **Recommendation 5.** If mussel transport through the pipeline is not possible, or if actions are taken to prevent it, then the City should test and assess the inspection program currently used to prevent introduction via trailered boats, and consider approaches to provide a more complete barrier (see Appendix C for details).

Section 6

Implementation

BC recommends that the implementation approach for Lake Hodges Reservoir may be phased into three major components.

- **Phase 1: Hodges Reservoir HOS.** The HOS system should be designed and constructed for the reservoir near the dam. An expedited approach for this phase of the project may consider a design-build scenario that may include performance provisions from the contractor and manufacturer.
- **Phase 2: Mid-Lake VEM.** The VEM system can be implemented either as the traditional design, bid and build approach or the expedited design-build method for construction.
- **Phase 3: Upper Wetlands.** Construction of 25 to 30 acres of wetlands will require coordination with the regulatory agencies. Community benefits include enhanced water quality and securing the water supply in the reservoir. Implementation of this component would include significant grading within the reservoir and adjacent slopes. Also, due to the proximity of the wetlands to the pedestrian bridge and bike path, there is an opportunity to incorporate multiple recreational benefits from this alternative that may result in grant funding. Implementation of this phase would include detailed design, environmental permitting, bidding, and construction.

6.1 Planning and Permitting

6.1.1 Community Coordination

Public Outreach/Community Meeting should be included as part of the pre-construction process for the City. This outreach would present a forum for informing the community of the project objectives and the potential construction effects.

Aesthetic impacts and potential for odors will be considered as part of the implementation of the HOS in Lake Hodges. Odors have not been a major issue in other areas where an HOS or VEM has been implemented. The best time to start the HOS would be before the shallow water (>5 m deep) gets hot and stratifies, between March-April. The system can be shut down when water cools in October.

6.1.2 Environmental Assessment and Regulatory Permits

An environmental assessment should be conducted for each phase of the proposed project to determine the appropriate documentation required under California Environmental Quality Act (CEQA). In addition, the regulatory permits will also be identified, which may include the California Department of Fish and Wildlife, Regional Water Quality Control Board, and US Army Corps of Engineers.

6.1.3 California Department of Water Resources, State Division of Safety of Dams

The proposed improvements are will not directly affect the Hodges Dam. It is not anticipated that this project would require approval from the DSOD.

6.1.4 Electrical Service

The proposed improvements require electrical service connection from the San Diego Gas and Electric for the HOS pumps, VEM pumps, and the Upper Wetlands intake pumps.

6.2 Preliminary Cost Estimate

6.2.1 Preliminary Project Development Cost

The total project cost was estimated and provided in Table 6-1 below. Appendix B provides details for the order-of-magnitude for the capital construction cost estimates. Engineering and project administration costs are estimated at 20 percent of the capital cost. Environmental planning and permitting costs are also estimated below.

Table 6-1. Estimated Order-of-Magnitude Capital Costs for Lake Hodges Reservoir Algae Control Alternatives						
Alternative	Description	Engineering and Administration Cost ¹	Environmental Planning and Permitting ²	Construction Cost	Total Project Cost	Comments
1	Reservoir Hypolimnetic Oxygenation System	\$532,000	\$50,000	\$2,315,000	\$2,897,000	Based on a system production rate of 3 tpd. Larger systems would affect the capital cost of this alternative; e.g., a 6-tpd system would add about \$0.6 million.
2	Mid-Lake Vigorous Epilimnetic Mixing	\$233,000	\$50,000	\$1,111,000	\$1,394,000	The VEM system is being implemented to enhance surface mixing and considered a demonstration system.
3	Upper Wetlands Filtering	\$1,885,000	\$377,000	\$7,538,000	\$9,800,000	Upper Wetlands for algae filtering is based on an estimated 30-acre site with a net 25-acre area for water treatment.

¹ Assumes Engineering and Administration costs are estimated at 20% of the Capital Cost

² Estimated Environmental Planning and Permitting Cost

6.2.2 Preliminary Operation and Maintenance Cost

The annual operation and maintenance costs were estimated for the each of the alternatives below. The operation of the VEM and the HOS were estimated at 10 percent of construction costs. The wetlands will require initial establishment time for the planting and replanting for the first few years. The wetlands may also require reconstruction after a large storm event that results in flows on the spillway (elevation 315). As a result, the annual operation and maintenance cost for the wetlands were estimated at 12.5 percent of the capital construction cost.

Table 6-2. Estimated Annual Operating and Maintenance Costs		
Alternative	Description	Operation and Maintenance Cost
1	Hypolimnetic Oxygenation System	\$232,000
2	Vigorous Epilimnetic Mixing	\$111,000
3	Wetlands Filtering	\$942,000

6.3 Preliminary Implementation Schedule

6.3.1 Schedule Assumptions

Figure 6-1 below presents the projected schedule for design, permitting, and construction. The following assumptions were used to develop the schedule below. Appendix F provides the project schedule proposed in Figure 6-1 below.

- The City will conduct an Environmental Assessment to determine the appropriate documentation required under CEQA. In addition, the regulatory permits will also be identified, which may include the California Department of Fish and Wildlife, Regional Water Quality Control Board, and US Army Corps of Engineers.
- The implementation approach for these project alternatives will follow the traditional design, bid, build method of delivery. An alternative method, such as design-build, may be considered by the City to expedite the delivery schedule.
- We estimate the overall implementation schedule for the Reservoir HOS and the Mid-Lake VEM to each require 9 to 12 months for design and permitting, 3 months for bidding and award, and 9 to 12 months for fabrication and installation.
- For the Upper Wetlands, it is estimated that the process may require 18 months for design and permitting, 3 months for bidding and award, and 12 months for construction.

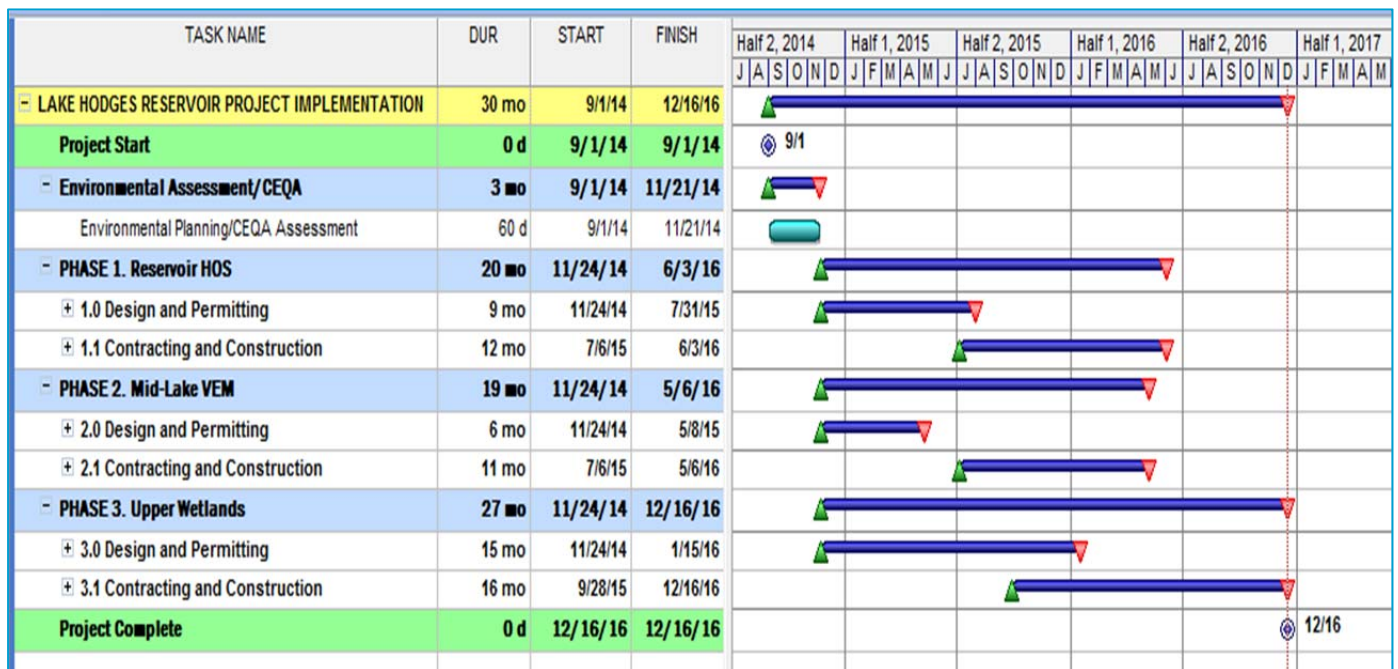

Figure 6-1. Preliminary Implementation Schedule

Section 7

Potential Additional Studies

Based on the work conducted for this report and agency reviews, the following studies may be considered for the Lake Hodges Reservoir.

1. **Algae Toxins and Taste-Odor Study.** An additional study may be conducted by the City of San Diego and its partner agencies to sample for Algae toxins and Taste-Odor. The effort may consist of sample collections spread over the algae growth season. The study also will quantify the algae types present in the reservoir.
2. **Sediment Oxygen Demand Testing.** Since modeling results from Water Quality Solutions point to considerable uncertainty in the sediment and hypolimnion oxygen demands, BC recommends that the City undertake sediment oxygen demand testing using sediment cores and bench-top reaction chambers from five to ten locations around the reservoir. Such testing will help quantify oxygen demand more definitely.
3. **Urban Wetland Development.** The proposed wetland should be evaluated to consider the overall improvements with the ongoing Proposition 50 and Proposition 84 studies for Natural Treatment Wetlands. Using a watershed approach for the Upper Algae harvesting wetlands, opportunities exist to integrate dry weather urban runoff treatment with the Upper Algae harvesting wetlands.
4. **Lake Hodges Reservoir Coordinated Water Quality Monitoring Program Study.** Ongoing monitoring of water quality will be useful for the determination of the project effectiveness and baseline conditions. This study would include an evaluation of the existing water quality monitoring programs and identify areas for a coordinated monitoring approach, and consolidate or focus monitoring efforts for the sole purpose of measuring the project effectiveness.
5. **Quagga Mussel Studies**
 - a. **Quagga Mussel Transport Study.** A Study could be conducted that includes additional sampling of the pump and turbine system to evaluate what percentage of viable Quaggas pass through this system into Lake Hodges Reservoir from Olivenhain Reservoir.
 - b. **Quagga Mussel Density Study.** A Study could be conducted to further evaluate the Quagga mussel densities through the water distribution system. This effort may consist of first an assessment of additional data that might provide insight into what may have reduced Quagga mussel densities in Olivenhain Reservoir, and then mapping an approach to evaluate the mussel density between Lake Hodges Reservoir to Olivenhain Reservoir. Additionally, this study should include the predicted outcomes of water quality/downstream impacts if Lake Hodges reservoir becomes infested with Quaggas.

Section 8

Limitations

This document was prepared solely for the City of San Diego Public Utilities Department in accordance with professional standards at the time the services were performed and in accordance with the contract between City of San Diego Public Utilities Department and Brown and Caldwell. This document is governed by the specific scope of work authorized by City of San Diego Public Utilities Department; it is not intended to be relied upon by any other party except for regulatory authorities contemplated by the scope of work. We have relied on information or instructions provided by City of San Diego Public Utilities Department and other parties and, unless otherwise expressly indicated, have made no independent investigation as to the validity, completeness, or accuracy of such information.

This document sets forth the results of certain services performed by Brown and Caldwell with respect to the property or facilities described therein (the Property). The City of San Diego recognizes and acknowledges that these services were designed and performed within various limitations, including budget and time constraints. These services were not designed or intended to determine the existence and nature of all possible environmental risks (which term shall include the presence or suspected or potential presence of any hazardous waste or hazardous substance, as defined under any applicable law or regulation, or any other actual or potential environmental problems or liabilities) affecting the Property. The nature of environmental risks is such that no amount of additional inspection and testing could determine as a matter of certainty that all environmental risks affecting the Property had been identified. Accordingly, **THIS DOCUMENT DOES NOT PURPORT TO DESCRIBE ALL ENVIRONMENTAL RISKS AFFECTING THE PROPERTY, NOR WILL ANY ADDITIONAL TESTING OR INSPECTION RECOMMENDED OR OTHERWISE REFERRED TO IN THIS DOCUMENT NECESSARILY IDENTIFY ALL ENVIRONMENTAL RISKS AFFECTING THE PROPERTY.**

Further, Brown and Caldwell makes no warranties, express or implied, with respect to this document, except for those, if any, contained in the agreement pursuant to which the document was prepared. All data, drawings, documents, or information contained this report have been prepared exclusively for the person or entity to whom it was addressed and may not be relied upon by any other person or entity without the prior written consent of Brown and Caldwell unless otherwise provided by the Agreement pursuant to which these services were provided.

Section 9

References

- Aldridge, D.C., P. Elliott and G.D. Moggridge. 2006. Microencapsulated BioBullets for the control of biofouling zebra mussels. *Environmental Science and Technology* 40: 975-979.
- Aquatic Sciences. 2006. 2006 Zebra Mussel Eradication Program, Millbrook Quarry, Haymarket, Virginia. Final Report. ASI Project M200650P, submitted to the Virginia Department of Game and Inland Fisheries, Richmond, VA. Aquatic Sciences L.P., Orchard Park, NY.
- City of San Diego, Public Utilities Department. Policies & Procedures for Vessel Inspections for Quagga Mussels. Hodges Reservoir.
- City of San Diego, Public Utilities Department. Agreement between the City and San Dieguito Water District and Santa Fe Irrigation District [regarding use of the Lake Hodges Dam and Reservoir]. City Document No. 00-18474. March 1998.
- City of Escondido and EDAW, Inc. Jurisdictional Urban Runoff Management Plan, submitted to the Regional Water Quality Control Board. March, 2008.
- Cohen, A.N. 2005. A Review of Zebra Mussels' Environmental Requirements. A report for the California Department of Water Resources, Sacramento CA. San Francisco Estuary Institute, Oakland, CA.
- Cohen, A.N. 2007. Potential Distribution of Zebra Mussels (*Dreissena polymorpha*) and Quagga Mussels (*Dreissena bugensis*) in California. Phase 1 Report for the California Department of Fish and Game. San Francisco Estuary Institute, Oakland, CA.
- Cohen, A.N. 2008a. Literature Review of the Exotic Mussels *Dreissena polymorpha*, *Dreissena bugensis*, *Limnoperna fortunei* and *Mytilopsis leucophaeata*. A report for the East Bay Municipal Utility District, the San Francisco Public Utilities Commission, and the Santa Clara Valley Water District. San Francisco Estuary Institute, Oakland, CA.
- Cohen, A.N. 2008b. Draft Action Plan to Address the Zebra Mussel Infestation at San Justo Reservoir, San Benito County, California. Prepared for the California Department of Fish and Game, San Benito County Water District and United States Bureau of Reclamation. San Francisco Estuary Institute, Oakland, CA.
- Dudek. 2013. Lake Hodges Natural Treatment System Options. A report for the San Dieguito River Valley Conservancy.
- GEI Consultants, Inc. 2008. Manual 2008-1 Lake Hodges Projects Reservoir Regulation Manual, April 2008 Final Report. Prepared for the San Diego County Water Authority, San Diego, CA.
- Jones & Stokes. 2007. Final Lake Hodges and Olivenhain Reservoir Limnology Study. Prepared for the San Diego County Water Authority.
- Lauria, J. 2009. Building a filter defense against zebra and Quagga mussels. *Water Conditioning & Purification* April 2009.
- Malloy, D.P. 2005. Biological Control of Zebra Mussels with *Pseudomonas fluorescens*: An Overview.
- Marrone Bio Innovations. California Approves Marrone Bio Innovations' Zequanox® for Invasive Mussel Control. <http://www.marronebioinnovations.com/2013/11/california-approves-marrone-bio-innovations-zequanox-for-invasive-mussel-control/> (June 2014)
- RNT Consulting, Inc. 2011. Vulnerability Assessment to Quagga Mussel Infestation for Olivenhain, Hodges and San Dieguito Reservoirs and Associated Facilities, Including a List of Viable Control Strategies. Assessment report prepared for the San Diego County Water Authority.
- San Diego County Water Authority. December 2010. Dreissenid Mussel Response and Control Plan.

State Water Resources Control Board. National Pollutant Discharge Elimination System (NPDES) - Pesticide Permits. http://www.waterboards.ca.gov/water_issues/programs/npdes/pesticides/weed_control.shtml. (June 2014)

United States Fish and Wildlife Service. 2005. Final Environmental Assessment, Millbrook Quarry Zebra Mussel and Quagga Mussel Eradication. Prepared by the Virginia Department of Game and Inland Fisheries, Wildlife Diversity Division, Richmond, VA.

Appendix A: Project Design Concept Details



CONCEPTUAL PLANS FOR LAKE HODGES RESERVOIR WATER QUALITY STUDY CITY OF SAN DIEGO PUBLIC UTILITIES MARCH 2014



VICINITY MAP
NOT TO SCALE

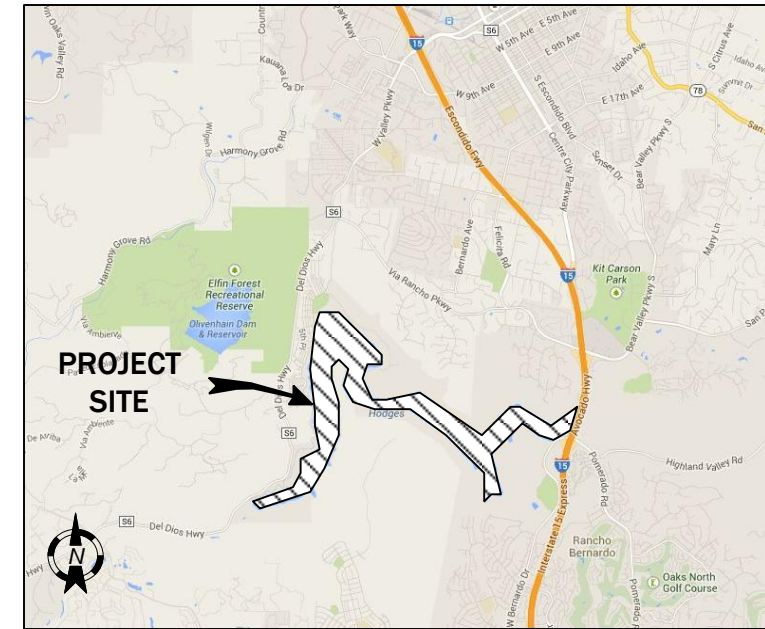

LOCATION MAP
NOT TO SCALE

INDEX TO PROJECT DRAWINGS

<u>SHEET NO</u>	<u>DESCRIPTION</u>
1	TITLE SHEET
2	GENERAL PLAN
3	RESERVOIR HYPOLIMNETIC OXYGENATION SYSTEM
4	MID-LAKE VIGOROUS EPILIMNETIC MIXING SYSTEM
5	UPPER ALGAE FILTERING WETLANDS
6	DETAILS OF HOS SPEECE CONE
7	HOS BUILDING LAYOUT
8	VEM BUILDING LAYOUT
9	VEM SCHEMATIC DIAGRAM





GENERAL PLAN

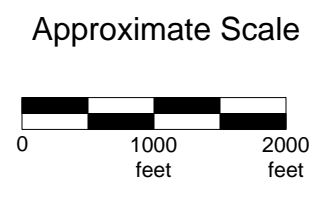

CITY OF SAN DIEGO
PUBLIC UTILITIES PROJECT, WATER BRANCH

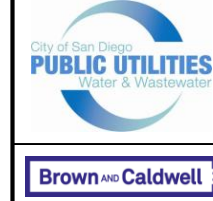

City of San Diego Public Utilities Department
Lake Hodges Reservoir Water Quality Study
GENERAL PLAN
 SHEET 2 OF 9

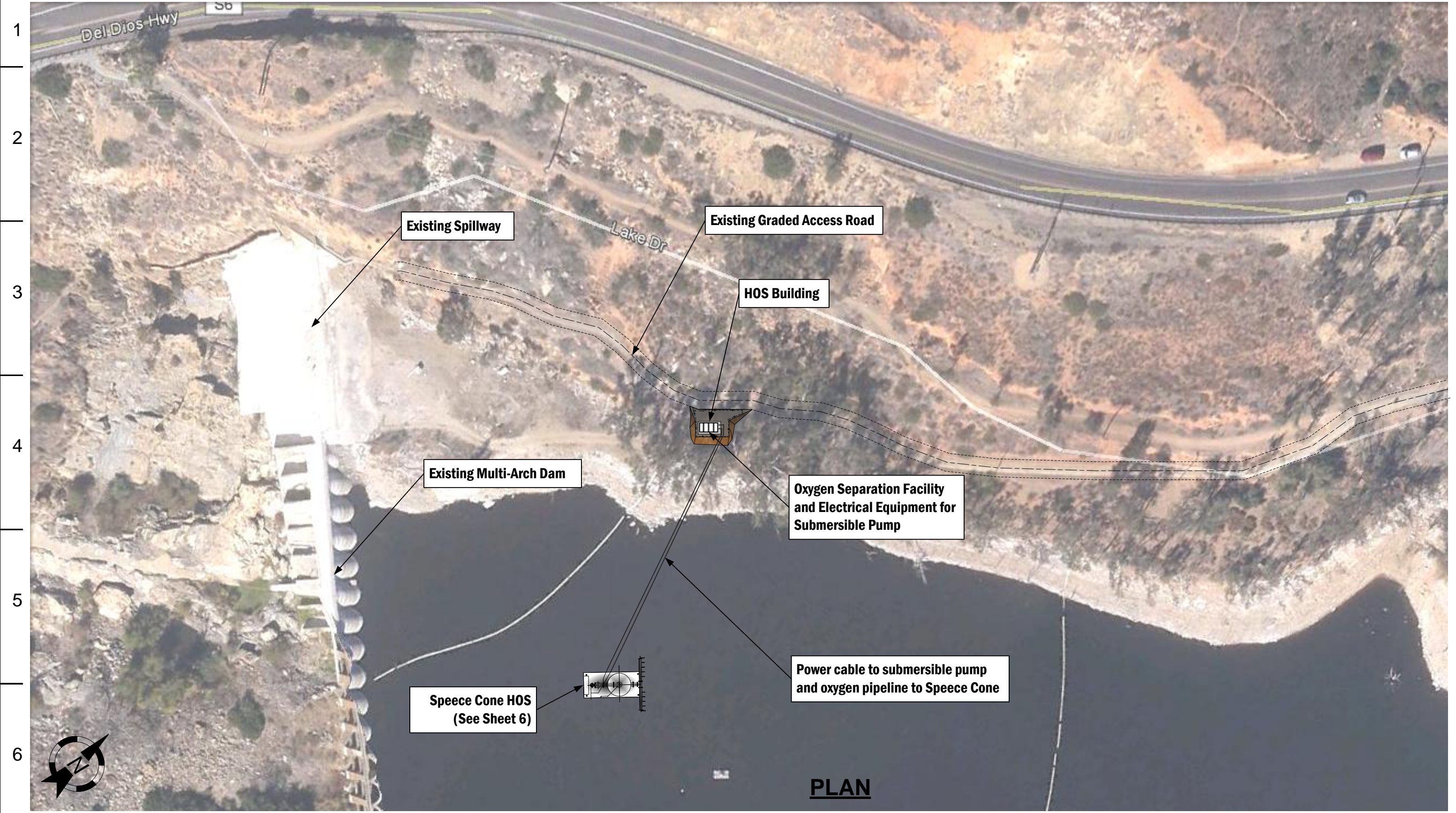

1
2
3
4
5
6
7

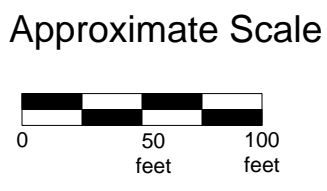

CITY OF SAN DIEGO
PUBLIC UTILITIES PROJECT, WATER BRANCH



City of San Diego Public Utilities Department
Lake Hodges Reservoir Water Quality Study
RESERVOIR HYPOLIMNETIC OXYGENATION SYSTEM
 SHEET 3 OF 9

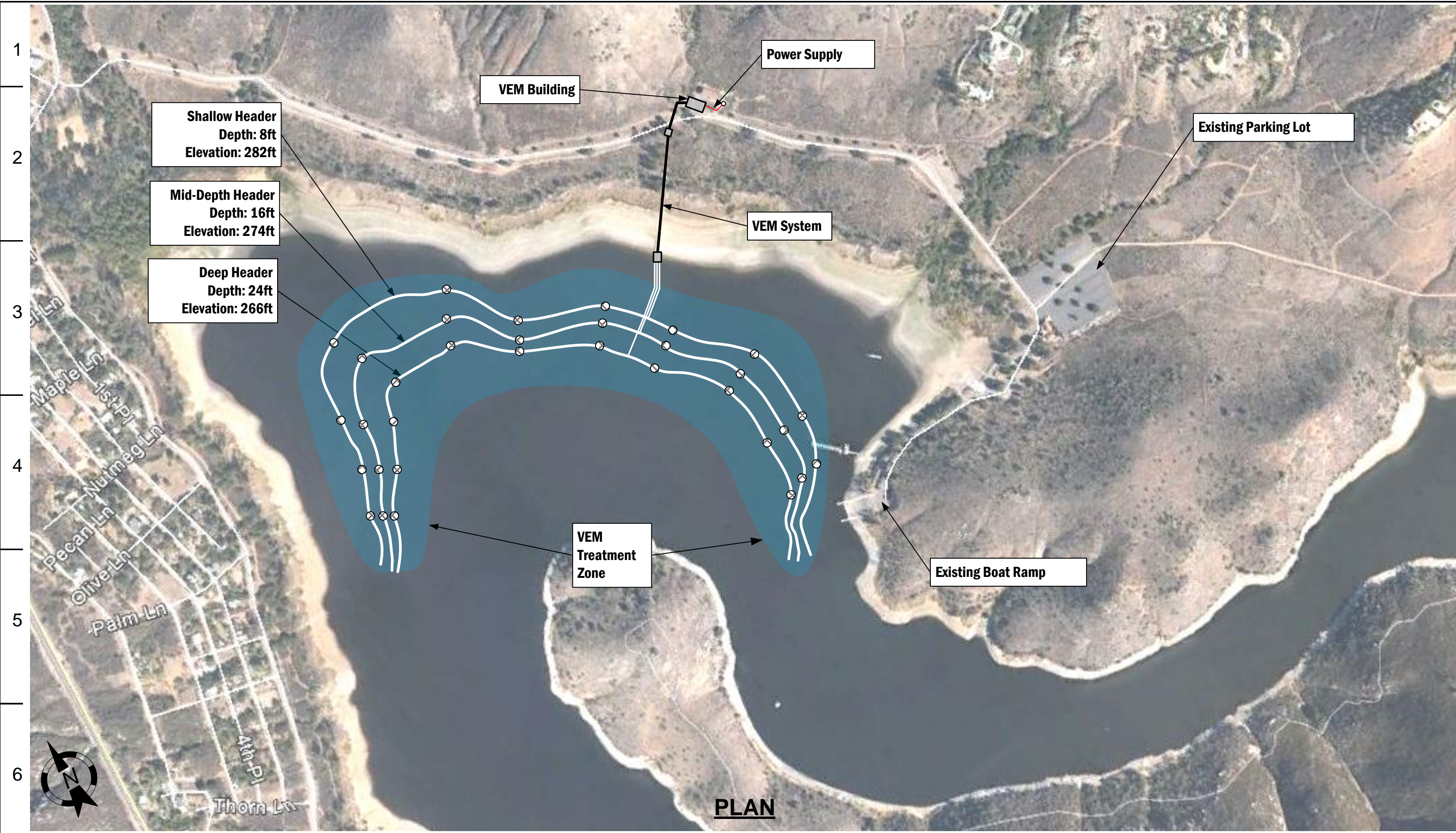

PLAN

Approximate Scale

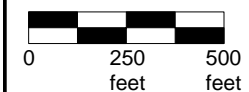

CITY OF SAN DIEGO
PUBLIC UTILITIES PROJECT, WATER BRANCH



City of San Diego Public Utilities Department
Lake Hodges Reservoir Water Quality Study
MID-LAKE VIGOROUS EPILIMNETIC MIXING SYSTEM
SHEET 4 OF 9



PLAN

CHANNEL NOTES:
 HIGH FLOW CHANNEL:
 240 FT WIDE AT BOTTOM
 SIDE SLOPE 3:1
 0.05 % SLOPE
 FREEBOARD OF APPROXIMATELY 2 FT

WETLAND NOTES:
 POTENTIAL WETLANDS AND BYPASS CHANNEL
 TOTAL AVAILABLE AREA, 207 ACRES
 NET WETLAND AVAILABLE AREA, 175 ACRES
 FOR ALGAE FILTER WETLANDS AREA - 30 ACRES
 NET ALGAE FILTER WETLANDS = 25 ACRES

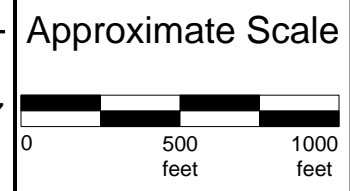

CITY OF SAN DIEGO
PUBLIC UTILITIES PROJECT, WATER BRANCH



Brown and Caldwell

City of San Diego Public Utilities Department
 Lake Hodges Reservoir Water Quality Study
 UPPER WETLANDS - ALGAE FILTRATION
 SHEET 5 OF 9

1

2

3

4

5

6

7

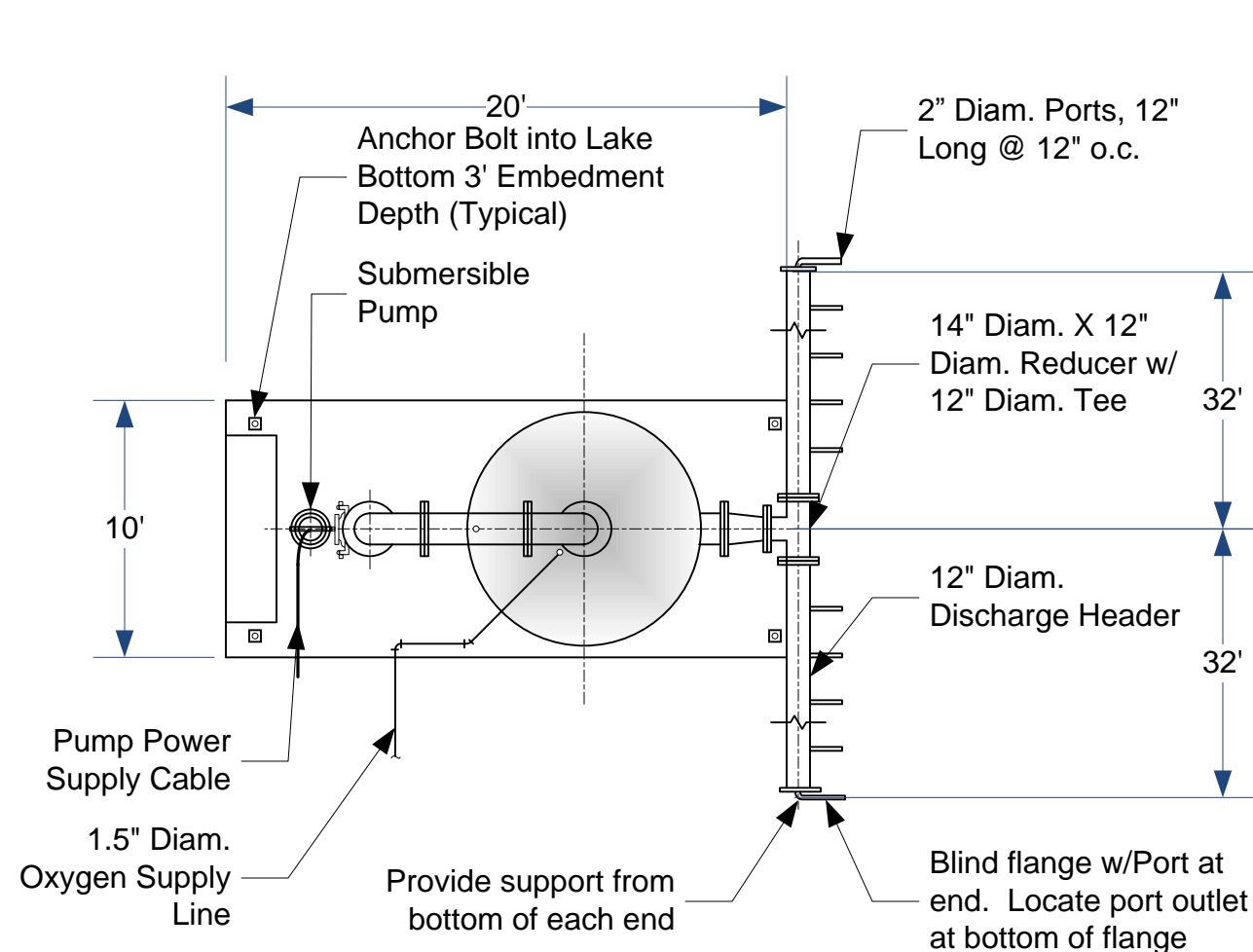

PLAN
NOT TO SCALE

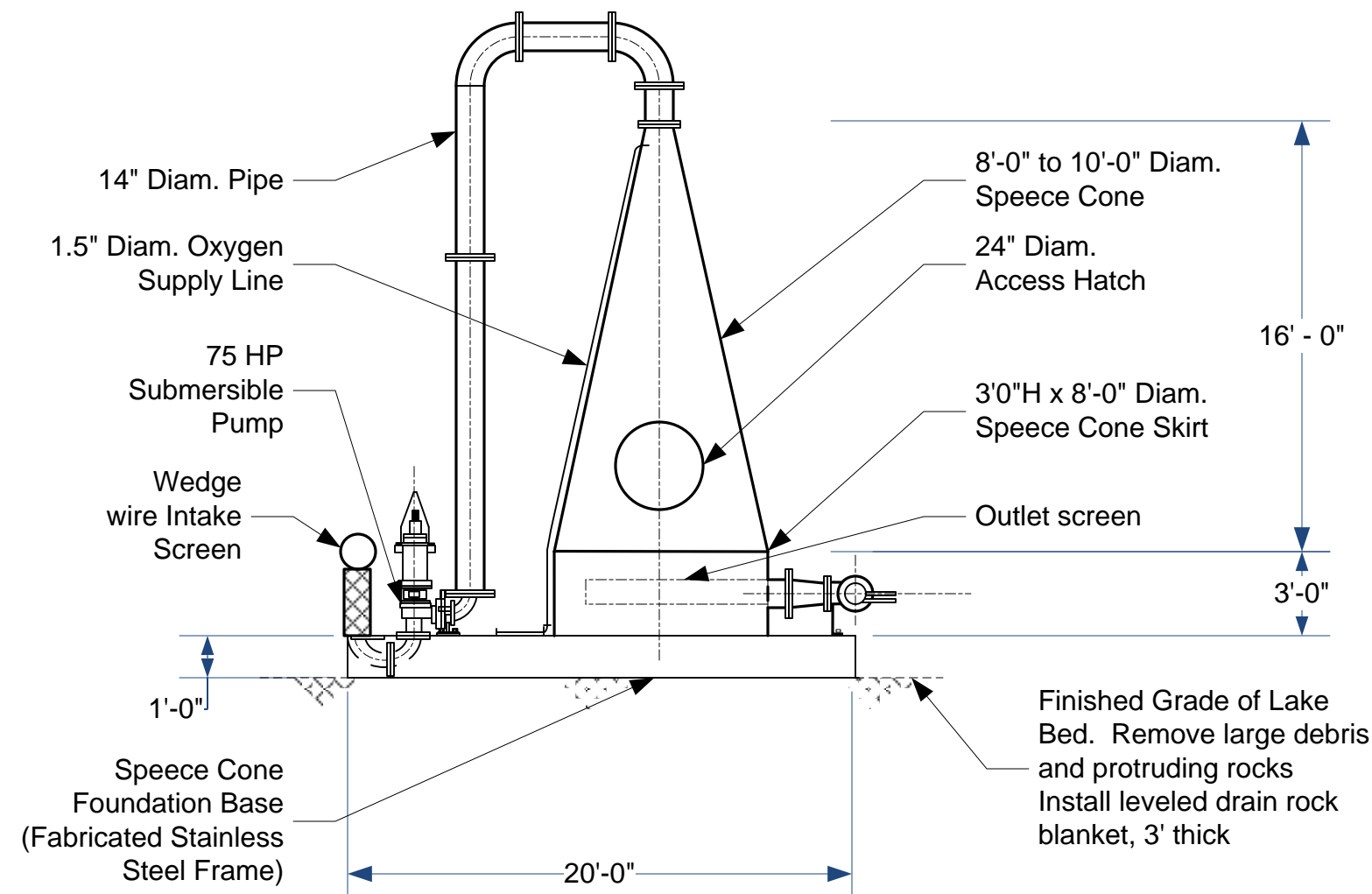

ELEVATION
NOT TO SCALE

Speece Cone Concept
DETAIL "A"
NOT TO SCALE

Approximate Scale:
NOT TO SCALE

CITY OF SAN DIEGO
PUBLIC UTILITIES PROJECT, WATER BRANCH



City of San Diego Public Utilities Department

Lake Hodges Reservoir Water Quality Study
SPEECE CONE DETAILS

SHEET 6 OF 9

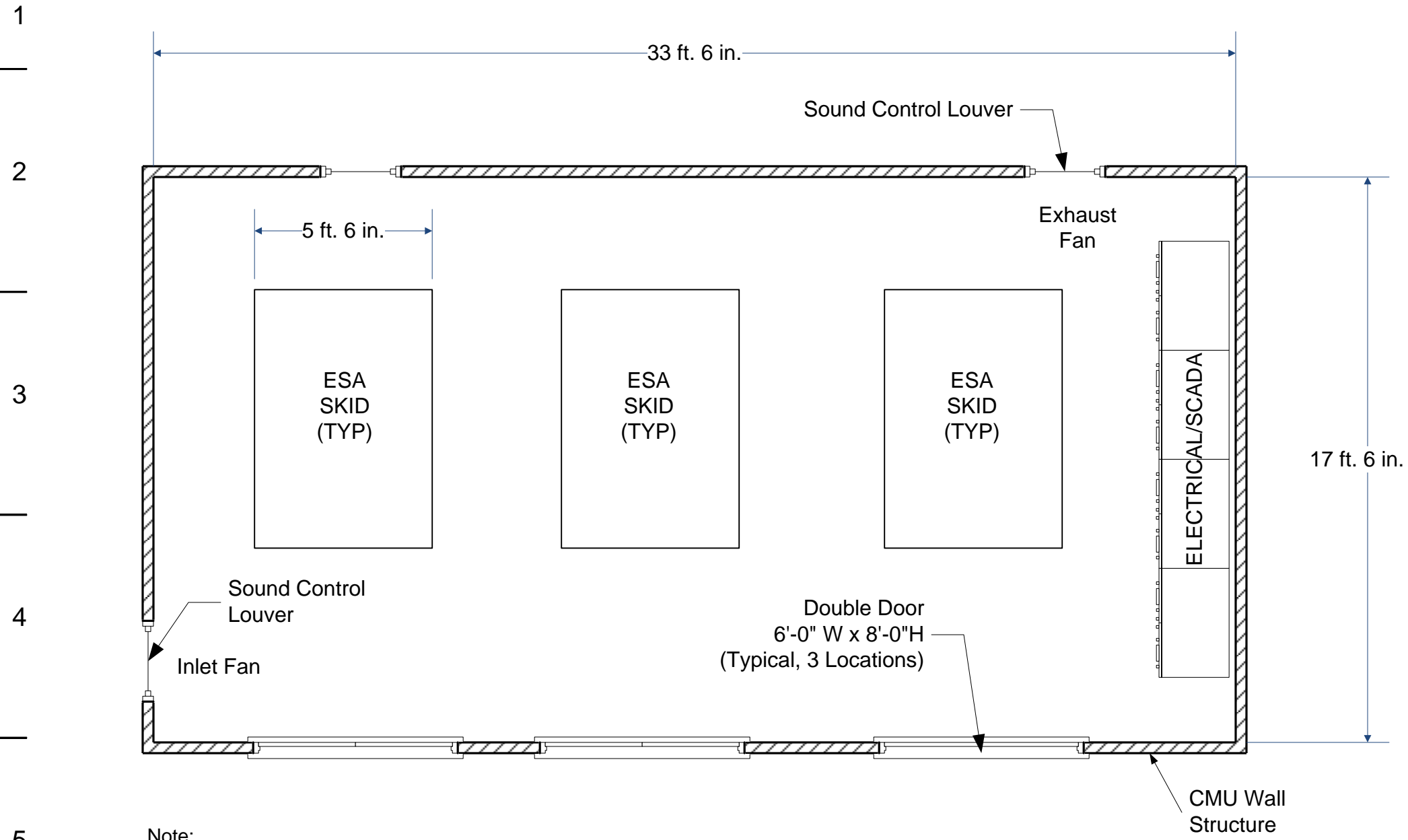

Note:
Interior Ceiling Height of 9'-0"

**HOS BUILDING LAYOUT
PLAN
SCALE: 1/4" = 1'-0"**

1
2
3
4
5
6
7

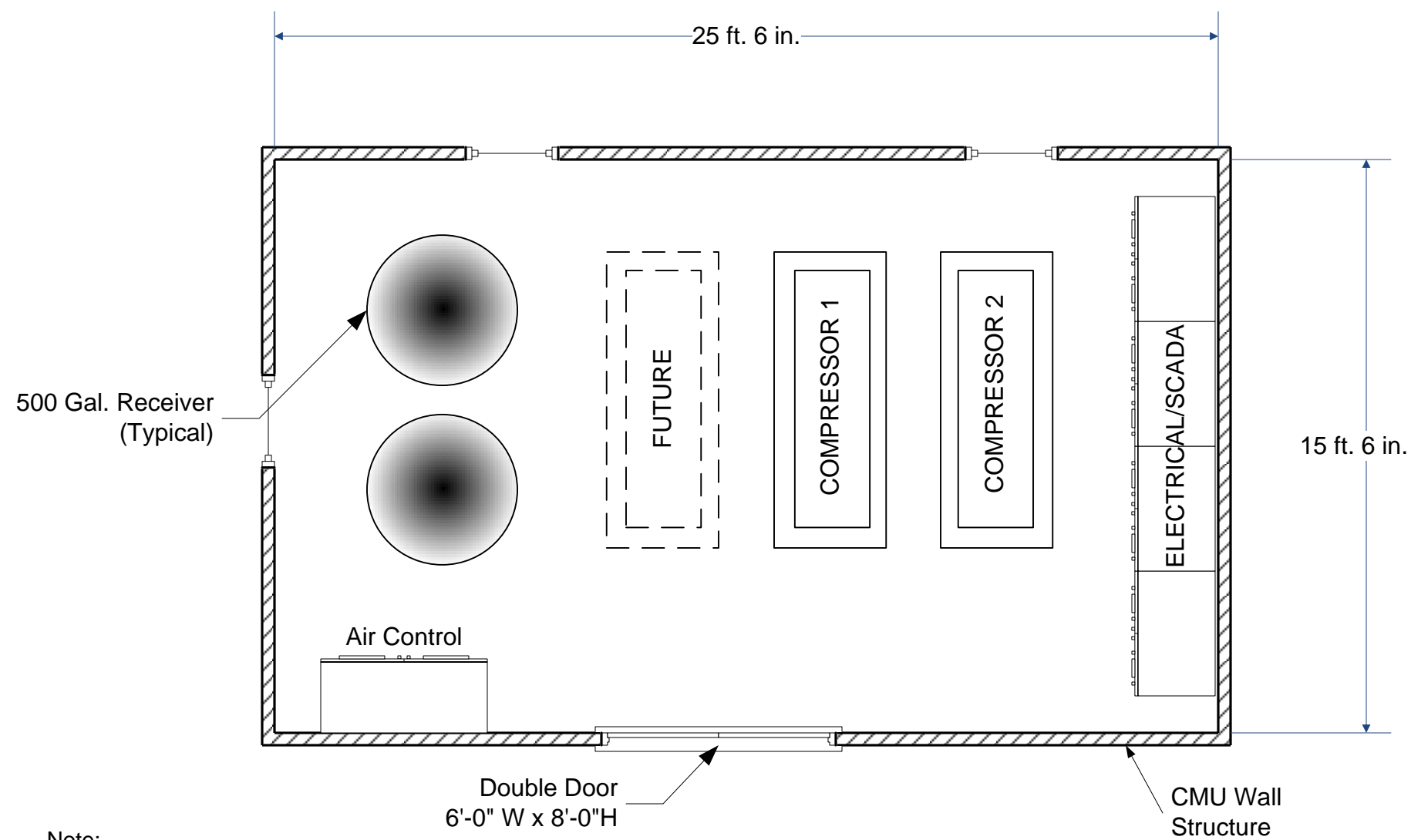

Note:
Interior Ceiling Height of 9'-0"

**VEM BUILDING LAYOUT
PLAN
SCALE: 1/4" = 1'-0"**

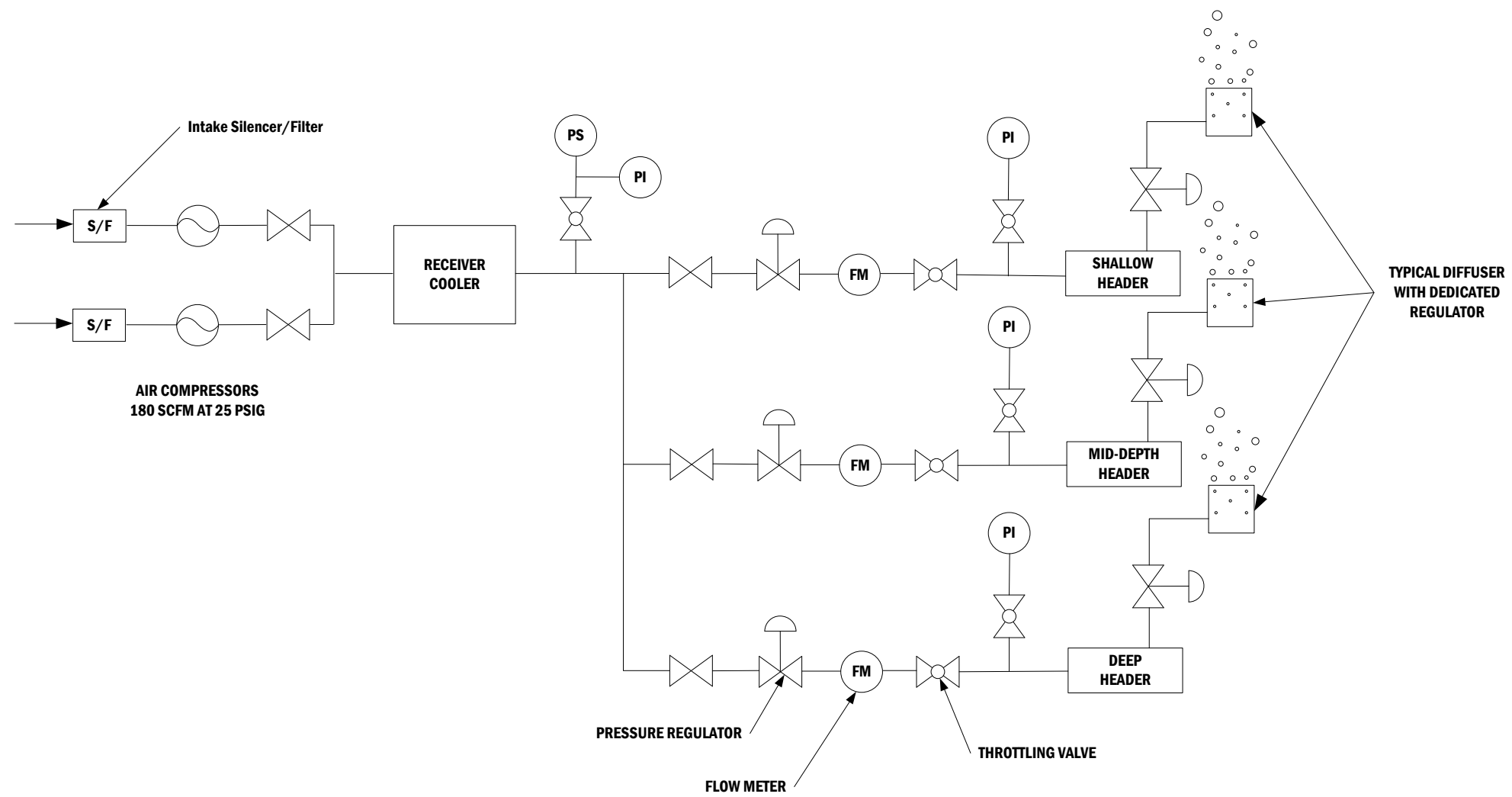

Schematic for VEM Air and Diffuser System

VEM DIFFUSER SYSTEM

Depth (ft)	Number of Diffusers	Diffuser Size (in)	Header Length (ft)
8	42	12	3200
16	21	9	3200
24	13	9	2800

Assume reservoir surface at 290 feet.

Approximate Scale
AS SHOWN

CITY OF SAN DIEGO
PUBLIC UTILITIES PROJECT, WATER BRANCH



City of San Diego Public Utilities Department
Lake Hodges Reservoir Water Quality Study
VEM SYSTEM SCHEMATIC DIAGRAM
SHEET 9 OF 9

Appendix B: Preliminary Construction Cost Estimate

Alternative		Engineering and Administrative Cost ¹	Environmental Planning and Permitting ²	Engineering, Admin, and Permits	Capital Cost (\$ Million)	Total Project Cost
Number	Description					
1	Reservoir Hypolimnetic Oxygenation System	\$ 532,000	\$ 50,000	\$ 582,000	\$ 2,315,000	\$ 2,897,000
2	Mid-Lake Vigorous Epilimnetic Mixing	\$ 233,000	\$ 50,000	\$ 283,000	\$ 1,111,000	\$ 1,394,000
3	Upper Wetlands Filtering	\$ 1,885,000	\$ 377,000	\$ 2,262,000	\$ 7,538,000	\$ 9,800,000

Notes:

1. Assumes Engineering and Administration costs are estimated at 20% of the Capital Cost
2. Estimated Environmental Planning and Permitting Cost

Alternative		Annual Operation and Maintenance Cost ³
Number	Description	
1	Reservoir Hypolimnetic Oxygenation System	\$ 232,000
2	Mid-Lake Vigorous Epilimnetic Mixing	\$ 111,000
3	Upper Wetlands Filtering	\$ 942,000

Notes:

3. Operation and Maintenance Costs are assumed at 10% for Alternative 1 , 2.
An O&M cost estimate of 12.5% is estimated for Alternative 3

Table 1. Opinion of Probable Construction Cost for HOS

Item	Units	Unit	Cost, dollars		Comments
			Cost per unit	Cost	
Site Work					
Site grading, civil improvements for building	lsum	1	5,000	5,000	
Subaqueous gravel pad	cy	30	250	7,500	Diver installed; 10 ft by 20 ft by 3 ft deep with side slopes away from skid
Building	sq ft	590	200	118,000	33.5 ft by 17.5 ft
Site Work Subtotal				130,500	
Mechanical					
ESA	each	3	120,000	360,000	Per vendor quote for skid-mounted system from Riverside CA
ESA installation	each	3	5,000	15,000	
Pump	each	1	50,000	50,000	Vendor quote
Pump installation	each	1	25,000	25,000	Includes power/monitoring cable; diver installed
Vent fans	each	2	2,500	5,000	5 hp with sound control louvers
Offshore oxygen piping	lf	300	15	4,500	1 1/2" diameter HDPE DR 13.5
Onshore oxygen piping	lf	100	45	4,500	1 1/2" diameter Sch 40 Type 316 SST, trenched with 3 ft of cover, native backfill
Speece cone	each	1	250,000	250,000	Vendor quote
Speece cone base	LB	2,000	7	14,000	Type 316 SST frame -- fabricated structural steel
Speece cone installation	each	1	180,000	180,000	Diver Installed
Mechanical Subtotal				908,000	
Electrical					
Electrical Service	each	1		0	600 amps, interior
Electrical Equipment	each	1		0	
Wiring	each	1		0	
EIC - Allowance	lsum	1	175,000	225,000	*This includes all items above and SCADA/I&C
SCADA	each	1		0	PLC
Electrical Subtotal				225,000	
Construction Subtotal				1,263,500	
Contractor's Mobilization/Overhead	percent	10	---	126,350	
Subtotal				1,389,850	
Contractor's Mark Ups	percent	10	---	138,985	
Subtotal				1,528,835	
Contingency	percent	40	---	611,534	
Subtotal				2,140,369	
Contractor's Bonding and Insurance	percent	5	---	107,018	
Subtotal				2,247,387	
Escalation to Construction Midpoint	percent	3		67,422	
Total Construction				2,314,809	
Total Project Cost				2,314,809	

Table 2. Opinion of Probable Construction Cost for VEM

Item	Units	Unit	Cost, dollars		Comments
			Cost per unit	Cost	
Site Work					
Site Grading	lsum	1	5,000	5,000	
Building	sq ft	400	200	80,000	25.5 ft by 15.5 ft
Buried piping	lf	300	60	18,000	2-inch ID, Type 316 SST schedule 40; backfill with native
VEM manifolds	lf	9,300	25	232,500	1 1/2-inch weighted pipe, 2 x 2" HDPE, weights at 20' c-c
VEM 9-inch diameter diffusers	each	42	200	8,400	EDI Flexible Membrane plus dedicated pressure regulator for each diffuser; cost includes diver installation
VEM 12-inch diameter diffusers	each	34	220	7,480	EDI Flexible Membrane plus dedicated pressure regulator for each diffuser; cost includes diver installation
Subtotal				351,380	
Mechanical					
Compressor	each	2	16,390	32,780	180 scfm each; 30 hp
Compressor installation	each	2	2,000	4,000	
Receiver	each	2	4,000	8,000	Two 500-gal galv steel tanks, incl. welds, straps, crane rent
Ventilation Fans	each	2	2,500	5,000	Same as HOS option
Air manifold	each	1	30,000	30,000	Includes pressure regulators, isolation valves, and thermal mass flow meters
Mechanical Subtotal				79,780	
Electrical					
Electrical Service	each	1		0	600 amps, interior
Electrical Equipment	each	1		0	
Wiring	each	1		0	
EIC - Allowance	lsum	1	175,000	175,000	This includes all items above and SCADA/I&C
SCADA	each	1		0	
Electrical Subtotal				175,000	
Construction Subtotal				606,160	
Contractor's Mobilization/Overhead	percent	10	---	60,616	
Subtotal				666,776	
Contractor's Mark Ups	percent	10	---	66,678	
Subtotal				733,454	
Contingency	percent	40	---	293,381	
Subtotal				1,026,835	
Contractor's Bonding and Insurance	percent	5	---	51,342	
Subtotal				1,078,177	
Escalation to Construction Midpoint	percent	3		32,345	
Total Construction				1,110,522	
Total Project Cost				1,110,522	

Table 3. Opinion of Probable Construction Cost for Wetlands

Item	Units	Unit	Cost, dollars		Comments
			Cost per unit	Cost	
Site Work					
Site Grading	Isum	1	5,000	5,000	Onshore electrical
Electrical Equipment - Concrete Pad	sf	100	12	1,200	10' X 10' X 12"
Grading for wetland	cy	500,000	3	1,500,000	Recontouring existing bottom
Wetlands	ac	25	50,000	1,250,000	Cost per Ron Crites for control structures, channels, minor grading and planting
Discharge pipe	lf	6,000	125	750,000	24" ID pipe HDPE DR 17 26" OD, floated into place and laid on reservoir bottom with concrete weights
			Subtotal	3,506,200	
Mechanical					
Floating Intake Structure	each	1	75,000	75,000	
Pumps	each	2	75,000	150,000	Vertical turbine, 75-hp; install costs incl in floating intake
Piping (Discharge Manifold)	Isum	1	20,000	20,000	Schedule 20 Type 316 SST, fittings, flanges, misc.
Check valves	each	2	6,500	13,000	12-inch swing check
Isolation valves	each	2	2,500	5,000	12-inch-gate valves
			Mechanical Subtotal	263,000	
Electrical					
Electrical Service	each	1		0	600 amps in walk-in outside enclosure
Electrical cabinet with chiller	each	1		0	Walk-in NEMA 3R enclosure
Electrical Equipment	each	1		0	
Wiring	each	1		0	
EIC - Allowance	Isum	1	150,000	150,000	This includes all items above and SCADA/I&C
SCADA	each	1		0	
Intake Pump Power Conduit - Onshore	lf	100	20	2,000	4" HDPE DR21- duct only
Intake Pump Power Conduit - Offshore	lf	300	15	4,500	4" HDPE DR21, weighted - duct only
SDG&E Service Conduit	lf	12,600	15	189,000	3 3" diameter conduits at 4200 ft each, sized for #1 AWG conductor with one conductor per phase; wire supplied and installed by SDG&E, not included in estimate
			Electrical Subtotal	345,500	
			Construction Subtotal	4,114,700	
Contractor's Mobilization/Overhead	percent	10	---	411,470	
			Subtotal	4,526,170	
Contractor's Mark Ups	percent	10	---	452,617	
			Subtotal	4,978,787	
Contingency	percent	40	---	1,991,515	
			Subtotal	6,970,302	
Contractor's Bonding and Insurance	percent	5	---	348,515	
			Subtotal	7,318,817	
Escalation to Construction Midpoint	percent	3		219,565	
			Total Construction	7,538,381	
			Total Project Cost	7,538,381	

ECO₂ Design Lake Hodges



Prepared By:



Eco Oxygen Technologies, LLC
3939 Priority Way South Drive,
Suite 400
Indianapolis, IN 46240
Phone: (317) 706-6484
www.eco2tech.com

Prepared For:



Bill Faisst, PE
Brown and Caldwell
Walnut Creek, CA

October 4, 2013



ECO₂ Background

ECO₂ SuperOxygenation systems (aka Speece Cone) for water and wastewater treatment are designed and produced by ECO Oxygen Technologies, LLC (ECO₂), an independent company headquartered in Indianapolis, Indiana. The technology is the pioneering effort of Dr. Richard Speece, Centennial Professor Emeritus of Civil and Environmental Engineering at Vanderbilt University, who invented the “Speece Cone”. ECO₂ has teamed with Dr. Speece to develop the next generation of oxygen dissolving technology. ECO₂ is the end supplier of these systems and is wholly responsible for the design, fabrication, installation oversight, and startup and training. ECO₂ Speece Cone systems have been developed using specific engineering know-how, trade secrets and project experience and operating history.

Engineering Know How and Trade Secrets

ECO₂ working in partnership with Dr. Speece has spent over a decade developing, perfecting and implementing Speece Cones throughout the United States and internationally.

Teaming with Dr. Speece, ECO₂ has gained invaluable firsthand experience and engineering know how to understand and master the interworking nuances required to be able to successfully design, fabricate and implement Speece Cone systems.

While the end product is a stainless steel Speece Cone, the design work, forethought, and engineering know how, all play a significant role in the Speece Cone’s ability to function as designed and meet the design objectives of the application.

In addition to being proficient in Speece Cone design, ECO₂ has gained significant experience and knowledge in ancillary equipment necessary for a fully functional Speece Cone system. This includes expertise in correctly specifying and sizing the side stream pump, oxygen supply, piping arrangements, civil and electrical works. ECO₂ knows how to operate and service the Speece Cone in multiple applications and system configurations.

Project Experience

Nothing takes the place of first hand project experience when it comes to successfully designing and implementing Speece Cone technology. Throughout the past decade, ECO₂ has supplied Speece Cones for a number of different applications and in different geographical locations throughout the United States and internationally. This vast project experience has made ECO₂ a recognized leader in supplying pure oxygen dissolution technologies for water quality and wastewater applications. This history and experience has given ECO₂ confidence in knowing that a Speece Cone designed for a particular application will perform as intended to meet the design objectives and goals of the project.

ECO₂ is committed to and continues to develop new and exciting product improvements and new applications which further broaden its offering.

See Attachment for an installation list highlighting select ECO₂ Speece Cone Installations.



Lake Hodges – Hypolimnetic Oxygenation

Basis of Design

Lake Hodges	
Oxygen Demand (lbs/day)	5,400
Lake Depth (ft) *Assumed depth of cone installation	85
Water Temperature (oC)	15

ECO₂ Speece Cone Design

ECO ₂ Speece Cone	
Diameter (ft)	8
Height (ft)	20
Inlet and Outlet Piping Size (in)	12
Sidestream flow rate (gpm)	4,200
Sidestream Pump Electrical Draw (hp)	23

The ECO₂ System consists of a hollow, stainless steel cone with no internal mixers, baffles or moving parts. The influent and effluent pipes are a minimum of 12” diameter, capable of passing water with debris without clogging. The dish-shaped bottom with the discharge pipe at the low point provides for a self-cleaning device with no need for maintenance.

Thank you for your consideration. We look forward to working with you on this project.

David Clidence, PE

President

Eco Oxygen Technologies, LLC

Appendix C: Quagga Mussel Assessment

Appendix C

Lake Hodges Reservoir Water Quality Study Quagga Mussel Control Issues



Andrew N. Cohen
Director, Center for Research on Aquatic Bioinvasions (CRAB)
5994 McBryde Ave, Richmond CA 94805-1164
Email: acohen@bioinvasions.com
Phone: (510) 778-9201

C.1 Introduction

This Appendix presents a detailed review of quagga mussels, the environmental conditions required for their growth, and the potential consequences of improving water quality in Lake Hodges Reservoir as it might affect Quagga mussel establishment and long-term survival.

The Center for Research on Aquatic Bioinvasions (CRAB) conducted extensive reviews of the quagga/zebra mussel literature regarding the environmental requirements of those mussels for studies done for other agencies in 1998, 2005, 2007 and 2009, and relied on those reviews in drafting the discussion in this report. The report notes where zebra mussel data is relied on in the absence of quagga mussel-specific data.

C.2 Environmental Requirements and Projected Changes

Current environmental conditions during some seasons or at some depths in Lake Hodges—including high nutrient and algal concentrations and low dissolved oxygen concentrations and pH—could be limiting for quagga mussels. Several of these conditions are expected to improve as a result of the recommended lake management projects, so that Lake Hodges would become a more suitable environment for quagga mussels to become established in and abundant.

Quagga mussels are broadcast spawners with fertilization occurring in the water column; the embryos then develop through a series of planktonic larval stages—initially shell-less worm-shaped larvae 57-121 μm long called trochophore larvae, growing into shelled larvae 70-500 μm long called veligers (sizes based on reported sizes for zebra mussels (Ackerman et al. 1994); quagga mussels are assumed to be similar)—before settling to the bottom and metamorphosing into the juvenile and adult form. In most aspects of their life cycle and environmental requirements quagga mussels resemble, or where data are absent or few are assumed to resemble, the better studied and more widely distributed zebra mussel. The most significant differences are that compared to zebra mussels, quagga mussels appear to be more capable of settling and growing on soft sediments; can spawn at lower temperatures; may be adapted to waters where food availability and/or predation pressure is lower; tend to colonize more readily and grow more abundantly in deep water; are less able to grow on vegetation; and appear to be slightly less capable of surviving aerial exposure.

For two important parameters, water temperature and calcium concentrations, Lake Hodges appears to be fully suitable for quagga mussels (Cohen 2007, 2008a; Jones & Stokes 2007; RNT 2011), though assessments of quagga mussels' calcium requirements are largely based on zebra mussel data.

Zebra mussels require at least 2-4 ppm of dissolved oxygen, depending on the temperature, and quagga mussels' requirements are assumed to be similar (Cohen 2007, 2008a). During the periods of stratification in 2003-2005 (from February or March to August/September in 2004 and through December in 2005), dissolved oxygen was near zero in the hypolimnion in Lake Hodges, while epilimnetic values ranged from above 5 ppm to above 14 ppm in different months (Jones & Stokes 2007, Figures 9 & 10). In 2010 dissolved oxygen was near zero at 6 m depth from April through October and near zero at 12 m depth for nearly the entire year (RNT 2011, Figure 5). Dissolved oxygen at the surface was above 8 ppm for most of the year and above 3 ppm for nearly the entire year (RNT 2011, Figure 5). Although RNT (2011) suggested that operation of the pump/generation facility could change these conditions so that low dissolved oxygen would no longer be a limiting factor for quagga mussels in the hypolimnion, simulations by Jones & Stokes (2007, Figures 23, 27, 32 & 37) showed hypolimnetic anoxia continuing during stratification periods even with operation of the pump/generation facility to support either emergency storage alone, or storage plus power generation. The proposed Hypolimnetic Oxygenation System should reduce, or perhaps eliminate, periods of low dissolved oxygen in the hypolimnion and improve conditions for quagga mussels in the lower part of the reservoir.

Zebra mussels require a pH of at least 7.3 or 7.4 based on distribution data and a laboratory study of veliger development (Cohen 2007, 2008a). Data are not available for quagga mussels, but their pH response is assumed to be similar. The pH levels in Lake Hodges' hypolimnion during the 2004-2005 stratification periods were usually between around 7.1 and 7.9, and thus could be limiting for quagga mussels at some times, but were generally above 8.0 in the epilimnion (Jones & Stokes 2007, Figures 9 & 10). In 2010 pH was below 7.3 for nearly the entire year at 12 m depth, but above 7.3 for most of the year at 6 m depth (RNT 2011, Figure 4). RNT (2011) suggested that operation of the pump/generation facility could raise pH so that it is no longer a limiting factor in the hypolimnion.

European studies have reported zebra mussels to be absent from hypereutrophic lakes, and absent or present only at low densities in lakes with high concentrations of nutrients or algae, and to decline or disappear in lakes as they became more eutrophic (Cohen 2005). One study found that zebra mussel density was negatively correlated with phosphate and nitrate concentrations, and that the mussels were absent where phosphate levels were above 18 mg/L; and developed a model predicting zebra mussel establishment and abundance based in part on these nutrient concentrations (Ramcharan et al. 1992). Quagga mussels' response to high concentrations of algae and nutrients is assumed to be similar. The mussels' negative response could be due to algae clogging their gills (Ramcharan et al. 1992) or to dense algae trapping veligers or making it difficult for them to swim (RNT 2011). RNT (2011) stated that at times during the year the surface concentration of chlorophyll a in Lake Hodges exceeded the upper threshold concentration for a sustainable population of quagga mussels (which they reported to be 25 µg/L), and is likely to limit the size of quagga mussel populations in the lake. RNT (2011) suggested that operation of the pump/generation facility could reduce the concentration of chlorophyll so that it would no longer be a limiting factor, but simulations by Jones & Stokes (2007) showed no substantial change in algal concentrations with operation of the pump/generation facility for either emergency storage alone, or storage plus power generation (compare Figures 24, 28, 33 and 38 to Figures 16). Several of the recommended lake management projects are intended to reduce algal concentrations, including Vigorous Epilimnetic Mixing on the

north side of the lake and the Filtering Wetland at the east end of the lake, and could thereby improve conditions for quagga mussels.

One proposed management action (harvesting carp and smaller food fishes) could have either a positive or negative effect on a quagga mussel population in the lake, depending on how the removal of these fish affected the populations of other fish or birds in the lake, and on the quagga mussel-consuming habits of the different fish and bird species. It would be challenging to quantify the ultimate impact of the proposed harvesting on a quagga mussel population, but it seems unlikely that it would be large.

C.3 Status of Quagga Mussels in Lake Hodges and Potential for Introduction

No adult quagga mussels have been found in Lake Hodges, and although two positive tests for quagga mussels in plankton samples have been reported (see below), in our view there is no significant evidence that quagga mussels are established in the lake. There are two main mechanisms by which quagga mussels could arrive in the lake: either transported as larvae through the Olivenhain-Hodges Pipeline from Lake Olivenhain where they had become established by January 2008 (SDCWA 2010), or transported overland on trailered boats. In both Europe and North America, quagga and zebra mussels have spread via contiguous waterways and water systems much more rapidly than they have spread overland—for a local example, by 2010 eleven of the 13 San Diego County reservoirs that received untreated water from the Colorado River had become infested with quagga mussels (the exceptions being Lake Hodges, which had yet received little water through the Olivenhain-Hodges Pipeline, and San Dieguito Reservoir, which receives water from Lake Hodges), while none of the 12 reservoirs that did not receive Colorado River water had become infested (SDCWA 2010, Tables 1 and A-1). If larvae are in fact transported alive through the pipeline from Lake Olivenhain, then this likely poses the greater risk to Lake Hodges.

Several studies have shown that bivalve veligers, including zebra mussels, can be killed by turbulence. According, SCDWA had engineering calculations done to estimate the expected mortality due to turbulence of quagga mussel larvae as they are transported from Lake Olivenhain to Lake Hodges through the pipeline and pump/generation facility (SDCWA 2010). These calculations were based on the dimensionless unit d^* , which is the ratio between the size of the organism and a quantity (the "Kolmogorov scale") that is related to the size of the eddies produced by the turbulence. Essentially, more intense turbulence produces smaller eddies; if an organism is small compared to the size of the eddy (that is, if d^* is small) then the eddy just moves the organism around, but if the organism is large compared to the eddy, then the eddy can tear the organism open or otherwise damage it (SDCWA 2010). Thus, for a given intensity of turbulence, small organisms are more likely to survive than large organisms (San Diego Regional Dreissena Mussel Response and Control Plan, December 2010). This plan was approved by the Department of Fish and Game on January 3, 2011 (See Appendix D).

The conclusion from these calculations was that all quagga mussel larvae of any size would be killed by the turbulence generated during passage through the turbines, and that the turbulence in the pipeline alone would kill all larger ($\geq 200 \mu\text{m}$) larvae (SDCWA 2010; see Table 4 and accompanying text on page 21, and the table and text on page A-7). Though a full review of these calculations is beyond the scope of this work, our review of the summary of the calculations in SDCWA (2010) and some of the source materials (Rehmann et al. 2003; the abstract from Jessopp 2007; AMEC 2009; Horvath & Crane 2010, which is the published version of Crane & Horvath 2007) suggest that this conclusion should be viewed with caution. We list here some concerns and questions:

- The estimated mortality rates for a given value of d^* are taken from a graph developed in AMEC (2009) (reproduced on Page A-6 in SDCWA 2010). This significant part of this graph is just a line drawn between 2 data points. The first data point (96% survival from 1 hour exposure to turbulence at a d^* of 0.9) is derived from a study that found 52% survival of zebra mussel veligers in a 16-hour passage down 18 km of Cristiana Creek in Michigan (Horvath & Lamberti 1999 cited in AMEC 2009), with the d^* value calculated by Rehmann et al. (2003). The size of the veligers was not reported and had to be guessed at. The second data point (0.02% survival from 1 hour exposure to turbulence at a d^* of 2.5) is derived from a study of the survival rate of larvae carried over a tidal rapids, for a variety of marine organisms (Jessopp 2007 cited in AMEC 2009), with the data point based on 54% survival of *Mytilus* veligers, a marine mussel that is unrelated to quagga mussels but whose adult form generally resembles them. Neither the size of the veligers nor the travel time through the rapids (and thus the period of exposure to turbulence) were reported, but were assumed or estimated by AMEC (2009). The critical data point for the Olivenhain-Hodges calculations is the second one, from which it was estimated that 1 hour exposure to turbulence at a d^* greater than 2.5 would result in 100% mortality. Several aspects of this data point—that veliger size and exposure time were not reported but had to be estimated, that it's based on a bivalve that is not closely related to quagga mussels, and that the mortality estimate involved a large extrapolation (extrapolating from 54% survival with an apparently very short exposure time (AMEC (2009) estimated the rapids were 100 m long, which even at a travel velocity of only 1-2 meters per second would result in an exposure of less than 1-2 minutes) to near zero survival with a 1 hour exposure time)—suggest that one should view the results cautiously.
- As noted, AMEC (2009) estimated zero survival from a 1 hour exposure to turbulence at a d^* greater than 2.5. However, Appendix A in SDCWA (2010), describing the Olivenhain-Hodges calculations, reports this as zero survival at 1 hour after exposure to turbulence. The language suggests that the Olivenhain-Hodges calculations assumed that an instantaneous exposure to turbulence at a d^* greater than 2.5 would produce 100% mortality, while AMEC (2009) had actually estimated that a one-hour exposure to turbulence at a d^* greater than 2.5 would produce 100% mortality (this is consistent with the source data in Jessopp (2007), in which exposure on the order of a minute or two killed 46% of the larvae). We emphasize that we have not reviewed the actual Olivenhain-Hodges calculations, only the summary and results, and it's possible that we are incorrect in our understanding that the calculations assumed 100% mortality from instantaneous exposure.
- Jessopp (2007), the source of data for AMEC's estimate that 1 hour exposure to turbulence at a d^* greater than 2.5 would kill all mussel veligers, reported that only the shelled veliger larvae of mollusks exhibited "significantly increased mortality" from passing through the tidal rapids, while other types of larvae, including the shell-less trochophore larvae of polychaetes (which, in general form, resemble the early-stage, shell-less trochophore larvae of quagga mussels) "showed no effect of turbulent tidal transport." This distinction, between impacts on shelled and shell-less larvae, is consistent with Horvath and Lamberti's (1999) observation of zebra mussel veligers that appeared to be pulled open during transport down a creek, with many empty but unbroken veliger shells observed, suggesting that the effect of turbulence may be to force open shells or to separate organism from their shells. If the mortality observed by Jessopp (2007) and used by AMEC (2009) in its model applies only to shelled veligers, with no mortality in unshelled larvae subjected to the same turbulence, then the application of the AMEC (2009) model to quagga mussel trochophore larvae in the Olivenhain-Hodges calculations is incorrect, and the conclusion that they would all be killed is unwarranted. Rather, the observations in Jessopp (2007) suggest that the trochophore larvae would all survive.

- The smallest larvae considered in the Olivenhain-Hodges calculations are 57- μm trochophore larvae, for which a d^* of 3.8 was calculated and 100% mortality was estimated since d^* was above the critical value of 2.5 (SDCWA 2010, table on p. A-7). However, quagga mussels are broadcast spawners, and fertilized eggs or eggs and sperm traveling separately could also be transported through the pipeline. Quagga mussel eggs can be as small as 40 μm in diameter (Ackerman et al. 1994). Since d^* is directly proportional to organism size for a given intensity of turbulence (Rehmann et al. 2003, Equation 1), the d^* for a 40- μm egg passing through the turbines, based on the Olivenhain-Hodges calculations, would be around 2.67 (linear extrapolation from the values in the table on p. A-7 in SDCWA (2010)). This is very close to the assumed critical d^* value for 100% mortality of 2.5. Thus even if the Olivenhain-Hodges calculations are entirely correct, it's not very certain that no eggs would get through. We note that observations of quagga mussels settled on the trash racks at the intake to the Olivenhain-Hodges Pipeline (RNT 2011, which predicted that the density of mussels on these trash racks could be expected to increase to the point of restricting flows) suggest that the mussels are well positioned to release eggs into the pipeline.
- Even if the Olivenhain-Hodges calculations are entirely correct, they calculated d^* for "turbine at maximum flow, which is the normal operating condition" (footnote to the table on p. A-7 in SDCWA (2010)). This raises the question of whether the turbines are ever operated at less than maximum flow, and what the corresponding d^* values and mortality rates would be. (They would presumably be lower.) Another question is whether any water ever bypasses the turbines when flowing through the pipeline to Hodges, for example during maintenance activities.

These considerations suggest that the conclusion that no live quagga mussel propagules will be transported through the pipeline into Lake Hodges cannot be entirely relied on, and so we should consider whether sampling data can confirm or refute this conclusion. Plankton sampling for quagga mussel veligers in Lake Hodges has been conducted either monthly over the entire year or monthly during the non-winter months, when quagga mussel veligers are most likely to be present in the water column (L. Prus, pers. comm. 2013). A single sample in April 2008 tested positive (SDCWA 2010, Table 1), possibly based on DNA testing. Another sample reported as positive, in October 2012, was based on microscopy (L. Prus, pers. comm. 2013). The latter record, though it reported "positive" for quagga mussels also reported the number present as zero, so if present they could not have been common. Since false positives have been reported fairly frequently for both microscopic identification and DNA-based identification of quagga and zebra mussels in plankton samples, we do not place great weight on single positive plankton samples in waters where adult mussels have not been observed.

The plankton samples collected by SDCWA and the City of San Diego for quagga mussel monitoring in Olivenhain Reservoir and Lake Hodges are taken from near-surface waters in the epilimnion (SDCWA 2010, page 22 and Appendix C; L. Prus, pers. comm. 2013). Since the Olivenhain-Hodges Pipeline releases water into the hypolimnion, the current method of sampling plankton in the epilimnion cannot be used to demonstrate that passage through the turbines does kill all the quagga mussel larvae. In addition, the pump/generation facility only began commercial operation in the summer of 2012, while substantial numbers of quagga mussel veligers were detected in Olivenhain Reservoir only in May/June 2009 and May 2010 (SDCWA 2010 Figure A-2; L. Prus, pers. comm. 2013); and because the hypolimnion in Lake Hodges is typically depleted of oxygen during the spring and summer, even if any larvae did get past the turbines they would probably have been quickly killed by low oxygen in Lake Hodges. Thus, appropriate conditions for testing whether the turbines kill any larvae that pass through them have not yet occurred.

Regarding overland transport, the City of San Diego inspects boats for quagga mussels before they are launched on Lake Hodges (RNT 2011; City of San Diego).

C.4 Possible Population Eradication/Control Approaches

There are several possible approaches for reducing or possibly removing a population of quagga mussels established in Lake Hodges, depending on the size and distribution of the population.

A small population with a restricted distribution could be treated by physical removal, covering, or covering and treatment with biocide. In Lake George in New York, divers removed 20,000 zebra mussels by hand, eliminating most of a population that, however, may have been dying out anyway due to low calcium concentrations (S. Nierzwicki-Bauer, pers. comm. 2009). In experiments in Lake Saratoga in New York, covering with plastic tarps for 9 weeks killed 99% of zebra mussels, possibly through reduced oxygen or lack of food (S. Nierzwicki-Bauer, pers. comm. 2009). In southern California, the non-native seaweed *Caulerpa taxifolia* was successfully eradicated using a combination of (a) removal by hand and (b) covering with tarps weighted around their edges and injecting liquid chlorine or placing chlorine tablets underneath the tarps. If an invading population of quagga mussels had a known and very limited distribution within Lake Hodges, it might be possible to eradicate it using these methods.

A population that was widespread but only in shallow water around the lake might be eradicated (and would at least be greatly reduced) by drawing down the water level for a period of time to expose the mussels to the air and allow them to desiccate. Laboratory and local climate data suggest that quagga mussels would survive less than 4-7 days of aerial exposure at Lake Hodges, depending on the season (Tables 1 & 2). This approach would require the draining of any puddles or pockets of water containing mussels to ensue eradication, which in turn would require a certain rainless period: even during the winter, in most winters several weeks would probably be a sufficient time to achieve this. SDCWA has used this approach to control quagga mussels in Lake Olivenhain, typically exposing about the upper 33 feet of the reservoir by drawing down to a surface elevation of around 1,045 feet (SDCWA 2010, pp. 20-21, A-4). SDCWA (2010) has noted that the likeliest opportunities to conduct drawdown and desiccation in Lake Hodges would occur in late summer or early fall.

**Table 1: Quagga Mussels' Maximum Survival Times (in days)
for Aerial Exposure in Laboratory Experiments. from Cohen (2008a).**

Relative Humidity	Temperature		
	10°C	15°C	20°C
<5%	-	5 ^a	-
10%	-	-	1-3 ^b
33%	-	5 ^a	-
50-53%	-	6 ^a	1-3 ^b
75%	-	7 ^a	-
≥95%	<10 ^b ; 10-15 ^c	13 ^a	3-5 ^b

^a Time to 100% sample mortality in 14-30 mm long mussels from Lake Erie (Ussery & McMahon 1994, 1995).

^b 12-18 mm long mussels from the St. Lawrence River (Ricciardi et al. 1995).

^c 21-24 mm long mussels from the St. Lawrence River (Ricciardi et al. 1995).

	Average Temperature ^a (°C)	Average Relative Humidity ^a (%)	Estimated Survival Time (days)
Jan	13	64	6-7
Feb	13	68	6-7
Mar	14	72	6-7
Apr	16	69	3-5
May	18	69	3-5
Jun	19	68	3-5
Jul	22	68	2-4
Aug	22	69	2-4
Sep	22	69	2-4
Oct	19	67	3-5
Nov	16	64	6-7
Dec	13	65	6-7

^a Based on climate data for the City of Escondido (<http://www.myforecast.com/bin/climate.m?city=11722>, accessed on 2/17/14).

A population that was present only in deeper water might be eradicated (and would at least be greatly reduced) by reducing oxygen levels in the deeper water. This could be achieved by temporarily halting operation of the Hypolimnetic Oxygenation System during the period of stratification and allowing the concentration of dissolved oxygen in the hypolimnion to decline. Vigorous Epilimnetic Mixing should probably also be temporarily suspended. Zebra mussels are reported to survive anoxic conditions for up to 6 days at 17-18°C and up to 3 days at 23-24°C; no comparable data are available for quagga mussels (Cohen 2005, 2008a). Assuming their response is similar, and considering the hypolimnetic temperatures in Lake Hodges (Table 3), quagga mussels would probably survive anoxia in the hypolimnion for no more than a week or ten days, even during the colder months. As noted earlier, low pH levels (below around 7.3-7.4) have sometimes been recorded in the Lake Hodges hypolimnion, and these could enhance the killing effect. SDCWA (2010, p. 21) estimated that there would be a total kill of quagga mussels in anoxic zones after 4 weeks, and total kill in zones with pH levels under 7.2 after 6 weeks.

	2004	2005
Jan	no data	12
Feb	no data	12-13
Mar	12-13	12-13
Apr	13-16	12-14
May	14-16	13-15
Jun	14-23	13-19
Jul	16-24	13-23
Aug	16-24	13-25
Sep	oxygen not stratified	13-22
Oct	22	13-22
Nov	18	13-18
Dec	12-13	13-15

A population of quagga mussels that ranged from shallow to deep waters in Lake Hodges could be reduced by partial drawdown and desiccation, by hypolimnetic oxygen reduction or (most effectively) by a combination of the two. With luck, the latter might even eradicate such a population, though one could not predict that with any assurance. MWD has used this combination of approaches on at least one reservoir for one summer month each year to control the quagga mussel population (SDCWA 2010, pp. 20, A-4).

A widespread, multi-depth population of quagga mussels could be reduced or possibly eradicated by whole-lake treatment with a biocide. A population of zebra mussels in a Virginia quarry pond was successfully eradicated by treatment with potash (also called muriate of potash; a mined fertilizer consisting of potassium chloride) (USFWS 2005; Aquatic Sciences 2006); a related marine mussel (*Mytilopsis sallei*) was successfully eradicated from lock-enclosed boat basins in northern Australia by treatment with copper sulfate (Cohen 2008b, pp. 31-32); and an attempt to eradicate zebra mussels from a lake in Nebraska by treatment with copper sulfate greatly reduced but did not eradicate the population. Additional biocide approaches worth considering are treatment with Zequanox®, a biocide derived from *Pseudomonas fluorescens* bacteria that is highly specific for quagga and zebra mussels, and which could reduce but is unlikely to eradicate a quagga mussel population (Malloy 2005); and delivery of a selected biocide via BioBullets, which would encase the selected biocide in an edible pellet of the size typically ingested by quagga mussels, and which thereby narrowly targets the delivery of the biocide to the mussels and reduces the risk of impacts to non-target organisms (Aldridge et al. 2006; Cohen 2008b, pp. 33-34).

The potential use of potash to eradicate a large zebra mussel population was studied at San Justo Reservoir in San Benito County, California (Cohen 2008b). The active ingredient in potash is potassium, which persists in suspension in the water column, enabling weeks-long exposure of quagga mussels in an enclosed water body at low dose, providing flexibility (exposure time is easily extended if tests show that not all mussels have been killed) and certainty of results. At the full treatment strength of 100 mg/liter of potassium, potash appears to have no harmful effects on other organisms except for other bivalves; while the only other bivalve likely to be present in Lake Hodges is *Corbicula fluminea*, a non-native clam that is also considered a pest species. Nor would there be any risk of harm to public health: water at full treatment strength would meet all state and federal ambient water quality and drinking water quality requirements (Cohen 2008b). In fact, a liter of water at full treatment strength would provide only a fraction of minimum daily intake of potassium and chloride recommended by the National Academy of Sciences (NAS 2005; Cohen 2008b).

Whole-lake treatment of Lake Hodges with a biocide is likely to be expensive, however. If drawn down to a surface elevation of 278 feet (the elevation of the Olivenhain-Hodges Pipeline outlet and also the surface elevation of the lake during much of 2002-2004), there would be 4,337 acre-feet of water to treat (Jones & Stokes 2007). Depending on the reservoir water level, water may enter either the epilimnion or the hypolimnion. Directly scaling up from the cost of treating of the 614-acre-foot Virginia quarry pond (which does not take into account inflation or potentially higher costs in California, which would increase the total, or economies of scale, which would decrease the total, or changes in the raw cost of potash, which fluctuates year-to-year and might either increase or decrease the total), a rough estimate for the cost of treating Lake Hodges would be around \$4 million. Costs for treatment with copper sulfate could be less, though eradication would be less certain; while costs for delivering a biocide via BioBullets could be considerably more (Cohen 2008b).

Since stratification of Lake Hodges persists through most of the year (Jones & Stokes 2007), any whole-lake treatment that wasn't implemented during the narrow period when the lake is mixed would need to take measures to ensure that the biocide was mixed throughout both the epilimnion and the hypolimnion. For biocides that tend to remain in suspension and persist for long periods, such as potash, that is fairly straightforward; for biocides that tend to sink to the bottom and/or

breakdown quickly, such as BioBullets and copper sulfate, it could be a challenge (Cohen 2008b). On the other hand, if the quagga mussel population to be eradicated was restricted to either the epilimnion or hypolimnion, lake stratification would allow targeting of that part of the lake with a biocide, reducing treatment costs and non-target impacts.

Finally, it would be theoretically possible to reduce a quagga mussel population in Lake Hodges by increasing or encouraging populations of quagga mussel-consuming fish or birds. While such an approach has sometimes been discussed in the literature, it has never been implemented, and aside from the practical challenges involved, it's unclear how large a difference it would make.

C.5 Recommended Lake Hodges Control Program

As discussed above, the recommended lake management projects are likely to raise the oxygen concentrations in the hypolimnion, which are currently too low to support quagga mussels for much of the year. Because the outlet from the Olivenhain-Hodges Pipeline is in the hypolimnion of Lake Hodges, and because quagga mussel eggs and larvae are most likely to be present in the water column in Olivenhain Reservoir and available for transport into Lake Hodges during the spring and summer months when Lake Hodges is stratified and the hypolimnion is anoxic, it may be that the low oxygen level in the hypolimnion is the main obstacle that has prevented Lake Hodges from being colonized by quagga mussels. (Additionally, in recent years, plankton sampling has shown only low concentrations of quagga mussel veligers in Olivenhain Reservoir, possibly due to less suitable water conditions for quagga mussels, in turn due to smaller inflows into Olivenhain from the aqueduct during this period (L. Prus, pers. comm. 2013). This will likely change at some not-too-distant point in the future.)

However, engineering calculations done for SDCWA concluded that no live quagga mussel larvae will enter Lake Hodges from Olivenhain Reservoir through the Olivenhain-Hodges Pipeline, because of turbulence caused by the turbines in the pump/generation facility. What SDCWA's priorities should be for actions regarding quagga mussels depends to a large extent on whether that conclusion is correct. For example, if quagga mussels cannot reach Lake Hodges through the pipeline, then there should be a greater focus on managing the other main mechanism by which they might arrive, via trailered boats; but if, on the other hand, quagga mussels can make it through the pipeline, then a more thorough assessment should be made of whether there are actions that could prevent that. Also, if quagga mussels can make it through the pipeline, then there is an urgent need for a more thorough assessment of whether anything could be done to respond to an invasion, and to ensure that adequate monitoring, decision and response systems are in place. This urgency arises from the fact that if quagga mussels are coming through the pipeline, then Lake Hodges will likely be invaded soon after the lake management projects raise the concentration of hypolimnetic oxygen. RNT (2011, p. 44) estimated that with larvae moving through the pipeline, mussels would become a significant nuisance in Lake Hodges within 2 to 4 months of water quality being improved. We do not have a prediction that is that time-specific, but concur that it could happen quickly, and likely within a couple of years.

Accordingly, we order our recommended actions as follows:

- **Recommendation 1.** First, the engineering calculations and the background studies for those calculations should be reviewed to determine whether the conclusion that no quagga mussel propagules will be transported through the pipeline can be relied on. This review should consider the issues and questions discussed in Section C.3 above.
- **Recommendation 2.** If the conclusion appears to be reliable, it should be tested by appropriate sampling of the water flows through the tunnel. This test sampling should be initiated when the plankton sampling conducted for general quagga mussel monitoring in Olivenhain Reservoir

shows a substantial concentration of quagga mussel larvae in the water column. Ideally this general monitoring would include samples taken near the location and at the depth of the intake to the pipeline; it would thus be helpful to make that adjustment to the monitoring sampling protocols. The test sampling would examine the plankton in water samples collected at the entrance to or in the upper part of the Olivenhain-Hodges pipeline and at the exit from or in the lower part of the pipeline, at a time when water was moving through the pipeline for electrical generation. A test that found substantial numbers of live quagga mussel larvae or eggs at the upper site and substantial numbers of dead larvae or eggs and no live larvae or eggs at the lower site would support the conclusion that larvae and eggs cannot be transported through the pipeline alive. Since the usual quagga mussel monitoring protocols only identify and count the shelled veliger stages in plankton samples, additional protocols for identifying and counting trochophore larvae and eggs should be employed. Methods for distinguishing live from dead larvae should also be employed: determinations based on integrity and motility can be used for veligers and trochophores, and live stains such as Neutral Red can be used for trochophores and eggs.

- **Recommendation 3.** If the assessment and/or testing of Recommendations 1 and 2 find that quagga mussel larvae can be transported alive through the pipeline, possible actions to prevent such transport should be assessed. This is especially important since if quagga mussels can be prevented from invading Lake Hodges Reservoir, they will also almost certainly be prevented from invading San Dieguito Reservoir, as the reservoir is closed to the public and Lake Hodges Reservoir is its only source of imported water; and there will be fewer impacts on facilities such as the Badger Treatment Plant that receives part of its water from Hodges and San Dieguito (RNT 2011). If transport of larvae through the Olivenhain-Hodges Pipeline is restricted to specific circumstances (*i.e.* only in some water that bypasses the turbines, or only when turbines are operated at less than maximum flow), mechanical or operational fixes to address those circumstances should be assessed. If, however, the problem is more general, then approaches that filter or treat the entire flow should be considered. While no system has yet been utilized to filter zebra or quagga mussels from the intake water for a hydropower plant, 25 μm filters have been used in at least two installations to filter zebra and quagga mussel larvae from water for a fish hatchery and an irrigation district (Lauria 2009), and 20-50 μm filters are used in various ballast water treatment systems to efficiently filter out zooplankton. Although filter systems large enough to handle the maximum flow through the Olivenhain-Hodges Pipeline will likely be expensive, they should be costed out and assessed.
- **Recommendation 4.** If quagga mussel larvae can be transported alive through the pipeline, and filtration or treatment systems that would eliminate such transport aren't feasible, then eradication or control responses such as those discussed in Section C.4 should be thoroughly assessed, and the monitoring, decision and response systems needed to ensure the timely initiation and implementation of appropriate eradication or control responses should be developed and put in place. A possible response action may include temporarily terminating water transfers between Lake Hodges Reservoir and Olivenhain Reservoir in concert with eradication/control measures.
- **Recommendation 5.** If the assessment and/or testing of Recommendations 1 and 2 shows that quagga mussel larvae cannot be transported alive through the pipeline, or if the assessments of Recommendation 3 lead to the installation of equipment or the implementation of approaches that will prevent that transport, then trailered boats would remain as the most likely mechanism by which quagga (or zebra) mussels could be introduced into Lake Hodges. In that case, a thorough assessment of the potential for such introductions should be conducted, and approaches that would provide a more complete barrier to such introductions should be considered and potentially pursued in collaboration with the City of San Diego. Currently, boats must be inspected before launching on Lake Hodges and the inspection criteria (City of San Diego) appear to be

fairly rigorous. However, boat inspection procedures have not, as far as we're aware, ever been tested, and boat inspections are unlikely to serve as a complete barrier. Additional approaches used at other sites to prevent the transport of quagga or zebra mussels, which could be considered, include restricting the types or sizes of boats that can be launched, barring some boats based on their history (*i.e.* where they are from or where they've been launched previously), requiring hot water washes of boats and trailers before launching, restricting boating to boats rented on-site, or barring boating on the lake. Alternately, the effectiveness of the current program of boat inspections could be tested, and improvements in inspection protocols or training made accordingly.

References for Appendix C

- Ackerman, J.D., B. Sim, S.J. Nichols and R. Claudi. 1994. A review of the early life history of zebra mussels (*Dreissena polymorpha*): Comparisons with marine bivalves. *Canadian Journal of Zoology* 72: 1169-1179.
- Aldridge, D.C., P. Elliott and G.D. Moggridge. 2006. Microencapsulated BioBullets for the control of biofouling zebra mussels. *Environmental Science and Technology* 40: 975-979.
- AMEC Earth and Environmental. 2009. Zebra/Quagga Mussel Veliger Transport Model, Tarryall to Cheesman Reservoir. Final Report to Denver Water.
- Aquatic Sciences. 2006. 2006 Zebra Mussel Eradication Program, Millbrook Quarry, Haymarket, Virginia. Final Report. ASI Project M200650P, submitted to the Virginia Department of Game and Inland Fisheries, Richmond, VA. Aquatic Sciences L.P., Orchard Park, NY.
- City of San Diego, Public Utilities Department. Policies & Procedures for Vessel Inspections for Quagga Mussels. Hodges Reservoir.
- Cohen, A.N. 2005. A Review of Zebra Mussels' Environmental Requirements. A report for the California Department of Water Resources, Sacramento CA. San Francisco Estuary Institute, Oakland, CA.
- Cohen, A.N. 2007. Potential Distribution of Zebra Mussels (*Dreissena polymorpha*) and Quagga Mussels (*Dreissena bugensis*) in California. Phase 1 Report for the California Department of Fish and Game. San Francisco Estuary Institute, Oakland, CA.
- Cohen, A.N. 2008a. *Literature Review of the Exotic Mussels Dreissena polymorpha, Dreissena bugensis, Limnoperla fortunei and Mytilopsis leucophaeata*. A report for the East Bay Municipal Utility District, the San Francisco Public Utilities Commission, and the Santa Clara Valley Water District. San Francisco Estuary Institute, Oakland, CA.
- Cohen, A.N. 2008b. Draft Action Plan to Address the Zebra Mussel Infestation at San Justo Reservoir, San Benito County, California. Prepared for the California Department of Fish and Game, San Benito County Water District and United States Bureau of Reclamation. San Francisco Estuary Institute, Oakland, CA.
- Horvath, T.G. and L. Crane. 2010. Hydrodynamic forces affect larval zebra mussel (*Dreissena polymorpha*) mortality in a laboratory setting. *Aquatic Invasions* 5(4): 379-385.
- Horvath, T.G. and T.A. Lamberti. 1999. Mortality of zebra mussel, *Dreissena polymorpha* veligers during downstream transport. *Freshwater Biology* 42: 69-76.
- Jessopp, M.J. 2007. The quick and the dead: larval mortality due to turbulent tidal transport. *Journal of the Marine Biological Association of the UK* 87: 675-680.
- Jones & Stokes. 2007. Final Lake Hodges and Olivenhain Reservoir Limnology Study. Prepared for the San Diego County Water Authority.
- Lauria, J. 2009. Building a filter defense against zebra and quagga mussels. *Water Conditioning & Purification* April 2009.
- Malloy, D.P. 2005. Biological Control of Zebra Mussels with *Pseudomonas fluorescens*: An Overview.

- National Academy of Sciences. 2005. Dietary Reference Intakes for Water, Potassium, Sodium, Chloride, and Sulfate. Panel on Dietary Reference Intakes for Electrolytes and Water, Standing Committee on the Scientific Evaluation of Dietary Reference Intakes, Food and Nutrition Board, Institute of Medicine of the National Academies. National Academies Press, Washington, DC.
- Ramcharan, C.W., D.K. Padilla and S.I. Dodson. 1992. Models to predict potential occurrence and density of the zebra mussel, *Dreissena polymorpha*. *Canadian Journal of Fisheries and Aquatic Sciences* 49(12): 2611-2620.
- Rehmann, C.R., Stoeckel J.A. and Schneider, D.W. 2003. Effect of turbulence on the mortality of zebra mussel veligers. *Canadian Journal of Zoology* 81: 1063-1069.
- Ricciardi, A., R. Serrouya and F.G. Whoriskey. 1995. Aerial exposure tolerance of zebra and quagga mussels (*Bivalvia: Dreissenidae*): implications for overland dispersal. *Canadian Journal of Fisheries and Aquatic Sciences* 52: 470-477.
- RNT Consulting, Inc. 2011. Vulnerability Assessment to Quagga Mussel Infestation for Olivenhain, Hodges and San Dieguito Reservoirs and Associated Facilities, Including a List of Viable Control Strategies. Assessment report prepared for the San Diego County Water Authority.
- San Diego County Water Authority. 2010. Dreissenid Mussel Response and Control Plan.
- United States Fish and Wildlife Service. 2005. Final Environmental Assessment, Millbrook Quarry Zebra Mussel and Quagga Mussel Eradication. Prepared by the Virginia Department of Game and Inland Fisheries, Wildlife Diversity Division, Richmond, VA.
- Ussery, T.A. and McMahon, R.F. 1994. Comparative study of the desiccation resistance of zebra mussels (*Dreissena polymorpha*) and quagga mussels (*Dreissena bugensis*). Pages 351-369 in: *Proceedings of the Fourth International Zebra Mussel Conference*, March 7-10, 1994, Madison, WI.
- Ussery, T.A. and McMahon, R.F. 1995. Comparative study of the desiccation resistance of zebra mussels (*Dreissena polymorpha*) and Quagga mussels (*Dreissena bugensis*). Technical Report EL-95-6, U.S. Army Corps of Engineers, Waterways Experiment Station, Vicksburg, MS.

Appendix D: San Diego County Water Authority Dresissenid Mussel Response and Control Plan

California Department of Fish and Game Letter dated January 3, 2011, approving the SDCWA's amended December 2010 Plan



State of California - The Natural Resources Agency
DEPARTMENT OF FISH AND GAME
4949 Viewridge Avenue
San Diego, CA 92123
<http://www.dfg.ca.gov>

ARNOLD SCHWARZENEGGER, Governor
JOHN McCAMMAN, Director



January 3, 2011

Maureen A. Stapleton
General Manager
San Diego County Water Authority
4677 Overland Avenue
San Diego, CA 92123-7233

**Subject: San Diego County Water Authority Dreissenid Mussel Response
and Control Plan**

Dear Ms. Stapleton:

Thank you for responding quickly to our December 30, 2010 letter regarding the San Diego County Water Authority's (Authority) Dreissenid Mussel Response and Control Plan (Plan). The Department of Fish and Game (Department) has received and reviewed the revised Plan, dated December 2010.

Our review of the October 2010 Plan found that the Plan lacked adequate measures to control the quagga mussel infestation within your system. The Department communicated that to the Authority in a letter dated November 17, 2010.

Since that time, DFG and Authority staff worked diligently together in an effort to identify possible control options not considered in your October 2010 Plan, and that if implemented, could enable the Department to approve an amended Plan. A recent collaboration between your engineers and engineers from RNT Consulting Inc. has concluded that turbulence generated in the water transport/hydroelectric facility between Olivenhain Reservoir and Lake Hodges will result in 100% mortality of all sizes and life-stages of dreissenid mussels that pass through this system. In a letter dated December 30, 2010 the Department requested the Authority incorporate this new information into an amended Plan. In addition, the Department requested additional information be included regarding monitoring and coordination with the City of San Diego to develop and support a boat inspection program for boats leaving Lake Hodges.

Our review of the amended December 2010 Plan has determined that the Authority has incorporated sufficient control mechanisms in the system to contain mussels. In particular, turbulence in the system, specifically in the turbines, is anticipated to result in 100% mortality of mussels, thus preventing the introduction of mussels into Lake Hodges, thereby meeting the requirements under Fish and Game Code (FGC) section 2301(d). Therefore, the Department hereby approves the Authority's amended December 2010 Plan.

Maureen Stapleton
January 3, 2011
Page 2 of 2

The Department appreciates the Authority's commitment to controlling quagga mussels in their water delivery/supply system, and their expedient amendment of their Plan to meet the requirements of FGC section 2301(d). The Department will continue to work with the Authority to update the Plan as needed and coordinate activities required under the Plan and the Fish and Game Code.

If you have any questions please contact me at 858.467.2702 or epert@dfg.ca.gov

Sincerely,



Edmund Pert
Regional Manager
South Coast Region

cc: John McCamman, DFG Director
Tom Gibson, DFG Office of the General Council
Nathan Goedde, DFG Office of the General Council
Susan Ellis, DFG Habitat Conservation and Planning Branch
Martha Volkoff, DFG Habitat Conservation and Planning Branch

Appendix E: Water Quality Model Assessment Study

Water Quality Solutions

1726 Three Springs Rd., McGaheysville, VA 22840

(540) 421-4638



Summary of Technical Memorandum

To: Oliver Galang and Bill Faisst, Brown and Caldwell
From: Imad Hannoun and Ira Rackley
Date: March 18, 2014
Subject: Lake Hodges Data Analysis and Modeling

To assess the potential long-term response of the reservoir to operation in conjunction with the emergency pumping system and proposed algae control systems, Brown and Caldwell engaged Water Quality Solutions (WQS) to perform a water quality modeling study of Lake Hodges. WQS performed one dimensional hydrodynamic and water quality modeling for proposed projects that may be implemented by the City of San Diego (City). This summary briefly reviews reservoir data analysis and modeling results. It presents key findings and recommendations from WQS. Details of the data analysis, calibration, and hypothetical model runs are included in a Technical Memorandum from WQS to Brown and Caldwell dated March 18, 2014.

1.0 DATA ANALYSIS AND SOURCES

WQS gathered various inflow, outflow and in-reservoir water quality data from the City and other entities for the period January 2008 to October 2013. The City collects near-weekly profiles of various water quality parameters at Station B, located near the Pump Storage (PS) structure. The City also collects runoff water quality data. The Santa Fe Irrigation District (SFID) operates an automated water quality profiler located near the dam. Meteorological data for model input were obtained from the California Irrigation Management Information System (CIMIS) station in Escondido. Volumes, temperature and dissolved oxygen (DO) of the PS water originating from Olivenhain reservoir, and return PS water volumes were obtained from the San Diego County Water Authority (SDCWA).

Lake Hodges has historically been fed by local area runoff, and outflow has been withdrawn through the dam for irrigation and water supply. As a result, the lake historically exhibited large volume fluctuations. In 2011, a PS system linking Lake Hodges with Olivenhain reservoir was established. The PS inflow causes significant entrainment and mixing in the vicinity of the inlet structure. Lake Hodges runoff inflows generally exhibit relatively high nutrient values for nitrogen and phosphorus as a result of influences by human activities in the watershed.

Lake Hodges stratifies similar to many other relatively-deep reservoirs in southern California. The thermocline is established at an approximate depth of 5 to 10 meters (m) in the summer. In the late fall, the thermocline deepens rapidly until turnover is achieved. From the spring to fall, the epilimnion features near-saturation levels of DO while the hypolimnion shows DO levels near zero. After turnover, and for a few weeks thereafter, DO levels within the entire water column are observed to be well under full saturation, and in some instances, there is total DO depletion in the entire water column at Station B. This phenomenon is not observed in most water supply reservoirs operated by the City. Chlorophyll *a* concentrations in the 50 to 100 $\mu\text{g/L}$ range are observed. Secchi depth values are typically less than 1 m for the majority of the time.

2.0 MODEL DESCRIPTION AND CALIBRATION

The one-dimensional water quality model DYRESM/CAEDYM, developed at the Centre for Water Resources at the University of Western Australia was used in this investigation. DYRESM/CAEDYM assumes that the lake is horizontally homogeneous and computes the vertical variations in temperature, salinity, and other water quality variables. Description of the algorithms and methodologies for DYRESM/CAEDYM can be found at <http://www.cwr.uwa.edu.au/software1/models1.php?mdid=2>.

The model calibration period extended from January 1, 2012 to October 20, 2013. Simulated temperature and DO contours compare well with observed data. In the calibration, the Sediment Oxygen Demand (SOD) rates that produce the closest agreement to the observed data in the overturn period are in the range of 3 to 6 $\text{g/m}^2/\text{day}$. It is also noted that since DO levels in the hypolimnion rarely rise above zero, it is not possible to accurately calculate the SOD rate. Since oxygen demand, which is strongly influenced by SOD rate, is important for sizing an HOS system, it is strongly recommended that sediment core DO demand investigations be conducted such as those done for San Vicente Reservoir (SVR) in 2001 by Mark Beutel, which determined SOD rates of 0.1 to 1.7 $\text{g/m}^2/\text{day}$. It is noted that SVR is significantly less productive than Lake Hodges.

3.0 MODEL RESULTS

After the calibration was completed, 10 “what-if” simulations were performed to assess lake water quality under various hypothetical scenarios. The simulations included model runs at different WSEL, different SOD rates, different hypolimnetic oxygen system (HOS) injection rates, as well as different depths for oxygen injection. Some model runs were performed to simulate Vigorous Epilimnetic Mixing (VEM).

The following text presents highlights of the results of specific model runs. It is noted that the results of the model runs are highly dependent on various assumptions about SOD and future lake operations, including WSEL and PS operations.

Figure 3-2.1 depicts results for Run #7, with 2 oxygen injection levels at an injection rate of 9,800 lbs O₂/day, SOD rate of 3 g/m²/day, VEM, and a WSEL of 315 ft. As shown, DO levels in the hypolimnion are typically at or above saturation. However, there exists an approximately 5 m thick vertical layer in the metalimnion that consistently features near-zero DO. If the SOD rate is at the high end of the expected calibration value of 6 g/m²/day, the thickness of the anaerobic metalimnion layer is expected to increase. If the SOD rate is decreased to 1.5 g/m²/day, the metalimnetic DO levels increase substantially compared to Run #7 (Run #8, **Figure 3-2.2**).

Figure 3-2.3 depicts results for Run #9, with 2 oxygen injection levels at an oxygen injection rate of 7,600 lbs/day, SOD rate of 3.0 g/m²/day, VEM, and a WSEL of 290 ft. As shown, DO levels in the hypolimnion are typically at or above saturation. There exists an approximately 2 m thick vertical layer in the metalimnion that intermittently features low DO. The reduction in size of the low DO metalimnion layer between Runs #7 and #9 is attributable to the reduced reservoir volume in Run #9.

Figure 3-2.4 depicts the results for chlorophyll *a* for Runs #7 and #9. As shown for Run #9 (WSEL = 290 ft), hypolimnetic oxygenation results in reductions in chlorophyll *a* level in the hypolimnion compared to an equivalent simulation with no oxygenation. These reductions are mostly noticeable in the summer and late fall as the thermocline deepens, with little or no reduction in the winter. For Run #7 (WSEL = 315 ft), the reductions in chlorophyll *a* are smaller than those for Run #9, likely a result of the larger hypolimnion and the near-zero DO zone in the metalimnion.

4.0 CONCLUSIONS AND RECOMMENDATIONS

Data Analysis (2008 to 2013)

- Episodes of low or zero DO routinely occur during the overturn period.
- Reservoir water oxygen demand is high and DO levels can drop from high values to zero in a matter of days.
- SOD rate cannot be accurately determined from existing information as DO levels near the bottom rarely exceed zero.
- Pump storage likely increases the vertical mixing above its inlet elevation.
- Sediment nutrient recycling occurs at a rapid pace in the anaerobic zone.
- Station B is likely affected by the localized impact of pump storage. It is recommended that City sampling be concentrated at Station A near the dam.

Calibration Results

- Increasing the simulation SOD rate results in dramatically higher in-lake DO demand and limited increases in chlorophyll *a*.

- An SOD rate between 3 and 6 g/m²/day produces the best agreement between model results and field data for DO and chlorophyll *a* in the fall and during the unstratified winter period.

Model Results

- For Run #7 at an SOD rate of 3 g/m²/day, a WSEL of 315 ft (full reservoir), 9,800 lbs O₂/day, and VEM, the hypolimnion is well oxygenated but near-zero DO values are observed in a 5 m thick band in the metalimnion for a significant portion of the year. If the SOD rate is increased to the high end of the expected calibration value of 6 g/m²/day, the thickness of this anaerobic metalimnion layer is expected to increase.
- For Run #8, which is identical to Run #7 but with an SOD rate of 1.5 g/m²/day, the metalimnetic DO levels increase substantially compared to Run #7.
- The size of anaerobic metalimnion layer decreases with lower reservoir volume.
- When the hypolimnion and metalimnion are well oxygenated, chlorophyll *a* decreases significantly in summer and fall but is virtually unchanged in winter.

Recommendations

- Increased vertical mixing and distribution of the HOS system discharge is recommended to oxygenate the entire hypolimnion and metalimnion.
- Sediment core characterization to measure the SOD rate is essential to the sizing of an HOS system.

Run #7: Temperature and Dissolved Oxygen

SOD rate = 3.0 g/m²/day, Oxygen Injection Rate = 9800 lbs/day

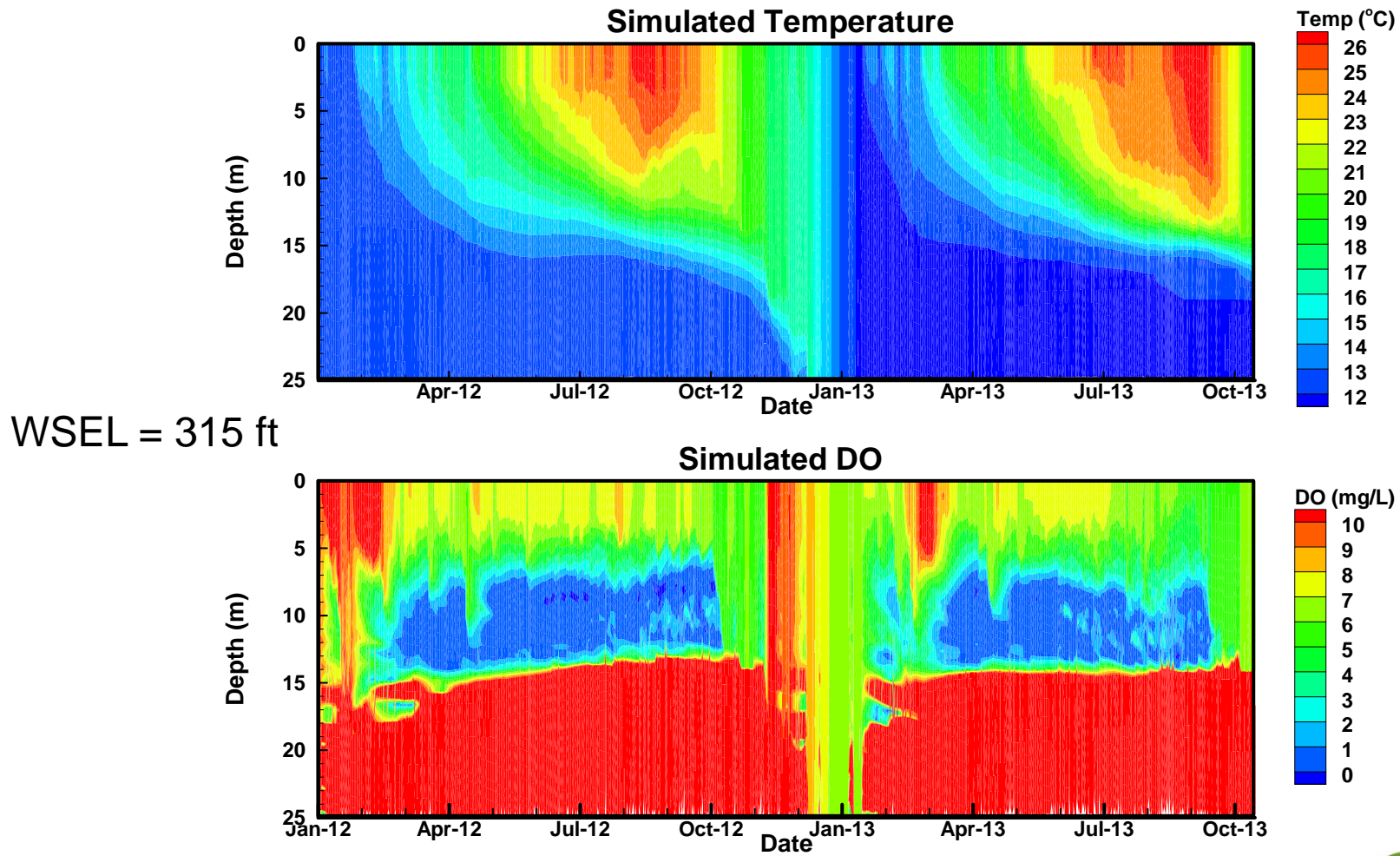
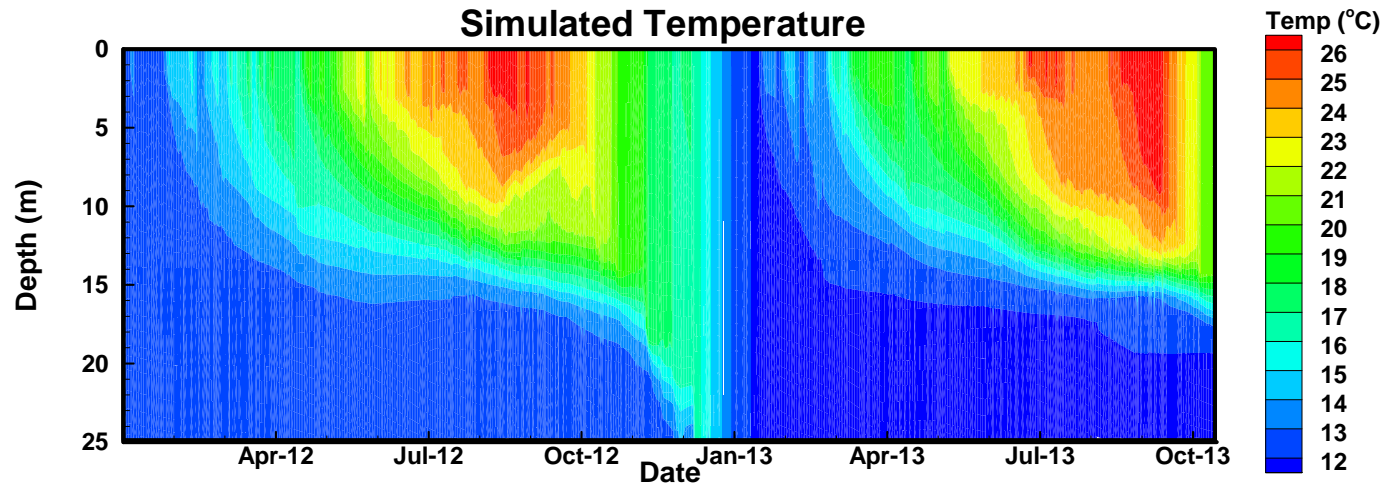

Figure 3-2.1



Run #8: Temperature and Dissolved Oxygen

SOD rate = 1.5 g/m²/day, Oxygen Injection Rate = 9800 lbs/day



WSEL = 315 ft

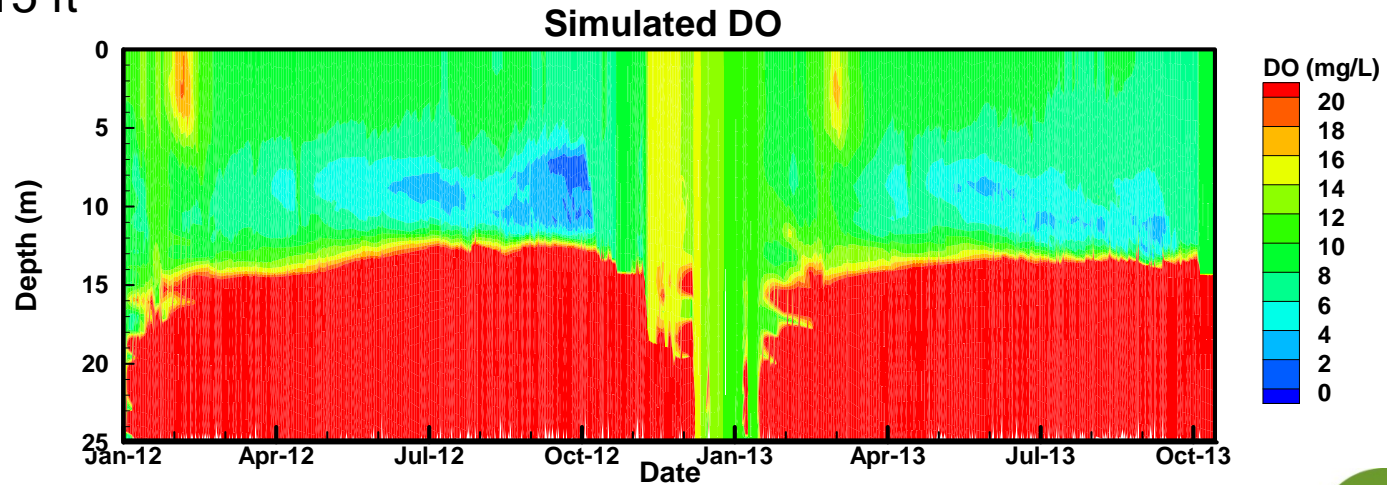

Figure 3-2.2



Run #9: Temperature and Dissolved Oxygen

SOD rate = 3.0 g/m²/day, Oxygen Injection Rate = 7600 lbs/day

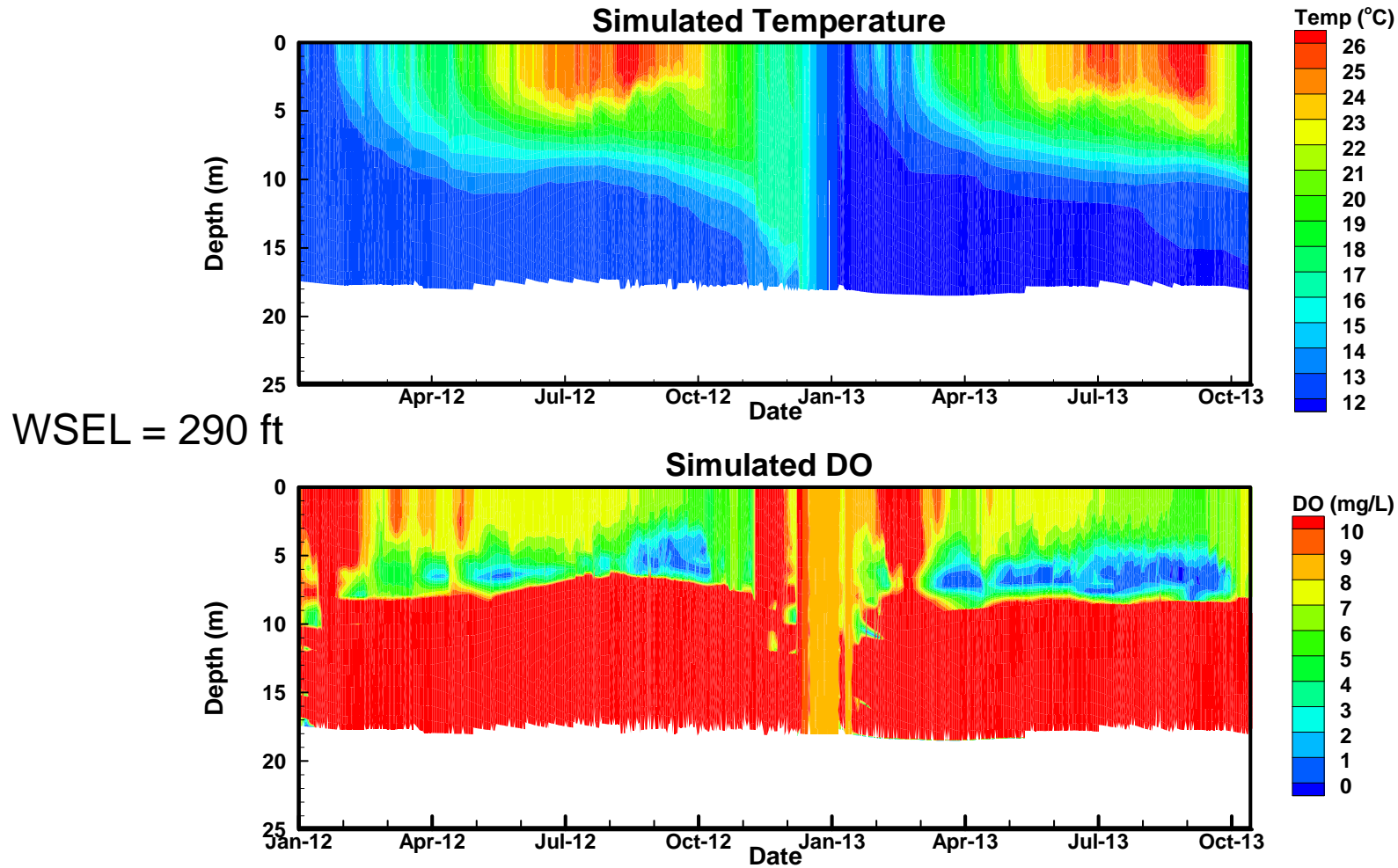
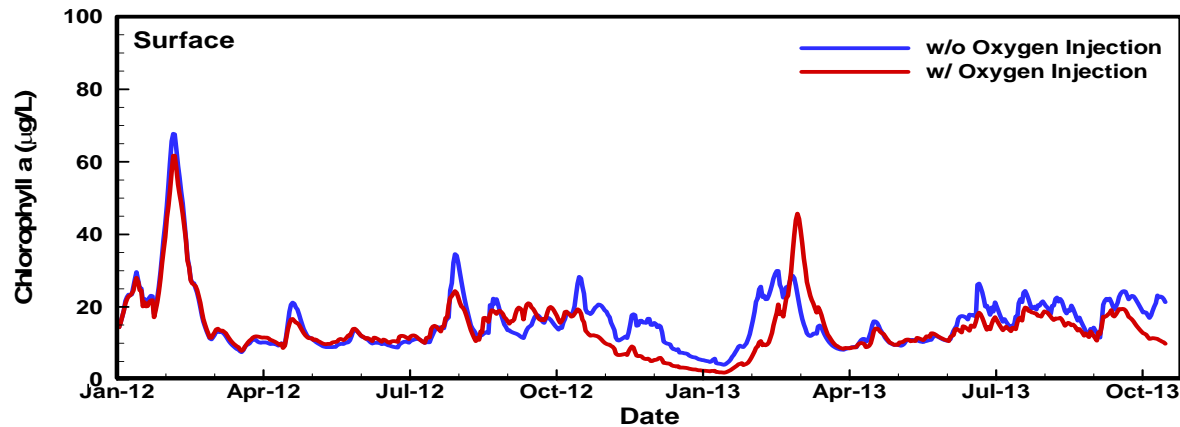

Figure 3-2.3

Run #7: Chlorophyll a

SOD rate = 3.0 g/m²/day, Oxygen Injection Rate = 9800 lbs/day



WSEL = 315 ft

Run #9: Chlorophyll a

SOD rate = 3.0 g/m²/day, Oxygen Injection Rate = 7600 lbs/day

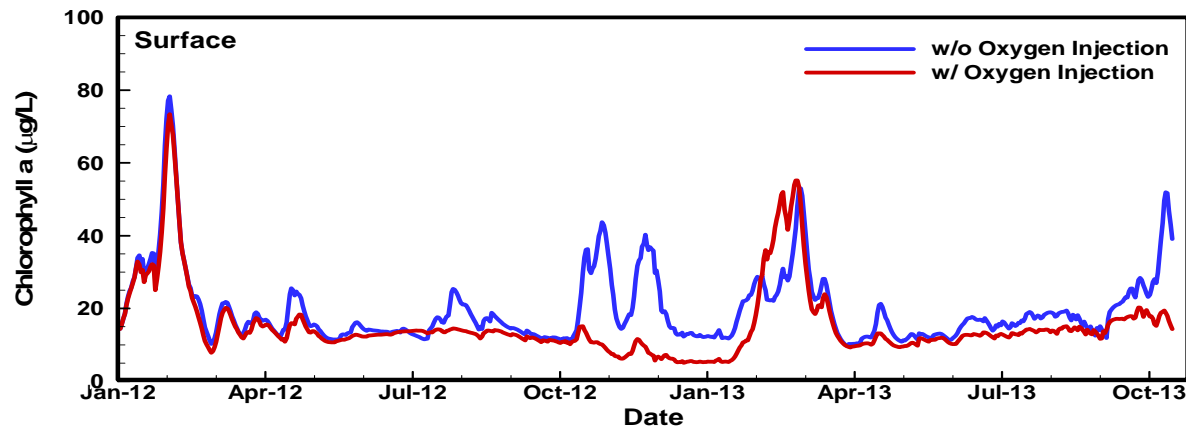

WSEL = 290 ft

Figure 3-2.4



Appendix F: Project Implementation Schedule

City of San Diego
LAKE HODGES RESERVOIR WATER QUALITY PROJECT
PROJECT IMPLEMENTATION SCHEDULE



TASK NAME	DUR	START	FINISH	Half 2, 2014					Half 1, 2015					Half 2, 2015					Half 1, 2016					Half 2, 2016					Half 1,						
				J	J	A	S	O	N	D	J	F	M	A	M	J	J	A	S	O	N	D	J	F	M	A	M	J	J	J	A	S	O	N	D
LAKE HODGES RESERVOIR PROJECT IMPLEMENTATION	30 mo	9/1/14	12/16/16																																
Project Start	0 d	9/1/14	9/1/14																																
Environmental Assessment/CEQA	3 mo	9/1/14	11/21/14																																
Environmental Planning/CEQA Assessment	60 d	9/1/14	11/21/14																																
PHASE 1. Reservoir HOS	20 mo	11/24/14	6/3/16																																
1.0 Design and Permitting	9 mo	11/24/14	7/31/15																																
1.01 Design	6 mo	11/24/14	5/8/15																																
Preliminary Design	4 mo	11/24/14	3/13/15																																
Final Design	2 mo	3/16/15	5/8/15																																
1.02 Regulatory Permitting	4 mo	3/16/15	7/3/15																																
1.03 Electrical Service Permits	3 mo	5/11/15	7/31/15																																
1.1 Contracting and Construction	12 mo	7/6/15	6/3/16																																
1.11 Contract Bid and Award	60 d	7/6/15	9/25/15																																
1.12 Construction	9 mo	9/28/15	6/3/16																																
PHASE 2. Mid-Lake VEM	15.5 mo	11/24/14	1/29/16																																
2.0 Design and Permitting	6 mo	11/24/14	5/8/15																																
2.01 Design	120 d	11/24/14	5/8/15																																
2.02 Permitting	90 d	11/24/14	3/27/15																																
2.1 Contracting and Construction	11 mo	3/30/15	1/29/16																																
2.11 Contract Bid and Award	60 d	3/30/15	6/19/15																																
2.12 Construction	160 d	6/22/15	1/29/16																																
PHASE 3. Upper Wetlands	27 mo	11/24/14	12/16/16																																
3.0 Design and Permitting	15 mo	11/24/14	1/15/16																																
3.01 Design	220 d	11/24/14	9/25/15																																
3.02 Environmental Permitting	120 d	12/22/14	6/5/15																																
3.03 Permits	80 d	9/28/15	1/15/16																																
3.1 Contracting and Construction	16 mo	9/28/15	12/16/16																																
3.11 Contract Bid and Award	80 d	9/28/15	1/15/16																																
3.12 Construction	240 d	1/18/16	12/16/16																																
Project Complete	0 d	12/16/16	12/16/16																																

Project: LAKE HODGES WATER QUALITY IMPROVEMENT PROJECT
Date: 6/17/14

Task		Project Summary	
Split		External Tasks	
Progress		External Milestone	
Milestone		Deadline	
Summary			

Appendix G: Stakeholder Coordination



Meeting Summary

9665 Chesapeake Drive, Suite 201
San Diego, California, 92123

Prepared for: City of San Diego, Public Utilities

Project Title: Lake Hodges Water Quality Assessment Study

Purpose of Meeting: Stakeholder Meeting and Project Status Update **Date:** September 17, 2013

Meeting Location: City of San Diego, MOC 2, Conference Room 2E
9192 Topaz Way, San Diego, CA

Time: 1:30 p.m.

Prepared by: Oliver Galang, PE, Project Manager

Summary

1. Introductions

The meeting began with general introductions from the Stakeholder's Group. In attendance included the following:

Amer Barhoumi, City of San Diego Project Manager

Rey Novencido, City of San Diego

Jeffery Pasek, City of San Diego

Surraya Rashid, City of San Diego

Rosalva Morales, City of San Diego

Craig Boyd, City of San Diego

Michael Williams, City of San Diego

Lisa Prus, City of San Diego

Tim Bailey, Santa Fe Irrigation District

Cor Shaffer, Santa Fe Irrigation District

Bill Faisst, Brown and Caldwell

Oliver Galang, Brown and Caldwell

2. Meeting Objective

The Objective of the meeting was to provide a status of the project to date and to discuss the approach chosen for the preliminary lake management options.

3. Recap of July 2, 2013 Site Visit

Oliver provided an overview of the site visit conducted at the Lake Hodges Reservoir on July 2, 2013. Bill Faisst provided key considerations about each of the site locations regarding available space, access conditions, and power supply. The following is a summary of the preliminary assessment.

Table 1. Site Evaluation Table

Site	Location	Area	Access	Power
1	Hodges Dam	North side near spillway	Accessible with narrow access road	3-Phase Power
2	RO Residence	Within RO Residence area plateau	Accessible with access road with Gate	Single Phase Power
3	EPS Staging Area	Graded area near the former staging area for the EPS construction	Accessible with access road	No Power Supply
4	EPS Site	Available area near the EPS Facility	Accessible with improved access road	3-Phase Power
5	Boat Ramp	Near recreation area and boat ramp	Accessible with improved access road	Single Phase Power

Comments received

1. *For the use of Site 2 (RO Residence): The location of the 3-phase power supply for submerged pump and for oxygenation system could come from two different sources. One from the dam and the other from the RO site.*
2. *The change in depth for the reservoir bottom between the dam and the area by the RO site is less than 5 feet, so the depth advantage should be evaluated.*
3. *The dam undergoes a spillway condition once every five years; therefore, any system proposed should consider the high water level during this condition.*

4. Potential Alternatives for Lake Management

Bill Faisst presented on the assessment that he and Alex Horne conducted on the lake management alternatives for Lake Hodges Reservoir. The main issues for the Lake Hodges Reservoir that need to be addressed are as follows:

- Excess algae
- Taste and Odor (organic)
- Taste and Odor (metals)
- Meet Water Quality Objectives
- Quagga Mussel Controls
- Maintain Water Habitat

The 17 methods of in-lake management were evaluated for application at Lake Hodges Reservoir, with the applicable methods selected. The following 5 combined methods were selected for application at Lake Hodges Reservoir, and listed in order of priority.

Table 2. Five Combined Methods for Lake Hodges Reservoir

No	Modified Method	Applicability for Lake Hodges
A	Hypolimnetic Oxygenation using a Speece Cone in the deeper thermally stratified lower reservoir	Method maximizes oxygen additions to the sediment-water interface to reduce internal nutrient loading; lower algae and T and O
B	VEM (Vigorous Epilimnion Mixing) combined with algae corraling	Reduces scumming blue-green algae in shallower mid (& upper?) reservoir regions, directs scums to collection points for wetlands filtration-removal
C	Wetland filters (off-line) will include Algae corraling prior to harvesting (removal in wetland)	High applicability, locate above upper end of reservoir; can also be used for summer & some winter urban contaminated runoff For blue-green algae scums, can be combined with #5 in algae corraling device
D	Biomanipulation	Recommended to remove carp, increase zooplankton and consider a new design floating wetland refuges
E	Algaecides/herbicides/molluscicides (& other Quagga treatments)	Emergency use only; high cost and regulatory problems downstream after WTP (aquatic biota sensitive to Cu, PAC20 cost high)

Comments received

1. *The Quagga Mussel Assessment should also address response actions to address evidence of Quagga Mussel population growth.*
2. *The Lake Hodges Reservoir issues also include bromides and manganese that should be considered in this report, if possible.*

5. Next Steps

- Water Quality Model Development – Oliver stated that Water Quality Solutions (WQS) requested for guidance regarding the model calibration period for Lake Hodges Reservoir. The Stakeholders agreed that 2012 and 2013 operation period would be best for this project, since the Emergency Pump Storage System was in operation beginning on September 2012. Oliver will convey the decision to Imad Hannoun of WQS.
- Quagga Mussel Assessment – Andrew Cohen will prepare an assessment of the proposed alternative with recommendations regarding monitoring of the Quagga mussels.

6. Project Schedule Update

Oliver provided an update on the progress of the project. The next stakeholder meeting, in approximately 2-months, will include the Quagga Mussel assessment by WQS and Andrew Cohen.

Brown AND Caldwell

City of San Diego Public Utilities

Lake Hodges Reservoir Water Quality, Stakeholder Meeting
September Update Meeting

September 17, 2013

City of San Diego
PUBLIC UTILITIES
Water & Wastewater







The collage consists of three photographs. The largest photo on the left shows a group of five people standing on a concrete ledge overlooking a large reservoir with a winding path in the water. The top-right photo is a close-up of a dam's spillway structure. The bottom-right photo is an aerial view of the reservoir surrounded by hills.



Introductions

Oliver Galang, PE

Brown AND Caldwell **BLACK & VEATCH**



• AGENDA

1. Introductions
2. Project Objectives
3. Project Team Site Visit (7/2/13)
4. Potential Alternatives for Lake Management
5. Next Steps
6. Questions and Comments

Brown and Caldwell 3

Project Objectives

- Develop In-Lake Management Actions to manage and control excessive algal productivity
- Actions to address the 303 (d) listings of water quality impairments





Project Team Site Visit

July 2, 2013



Lake Hodges Reservoir

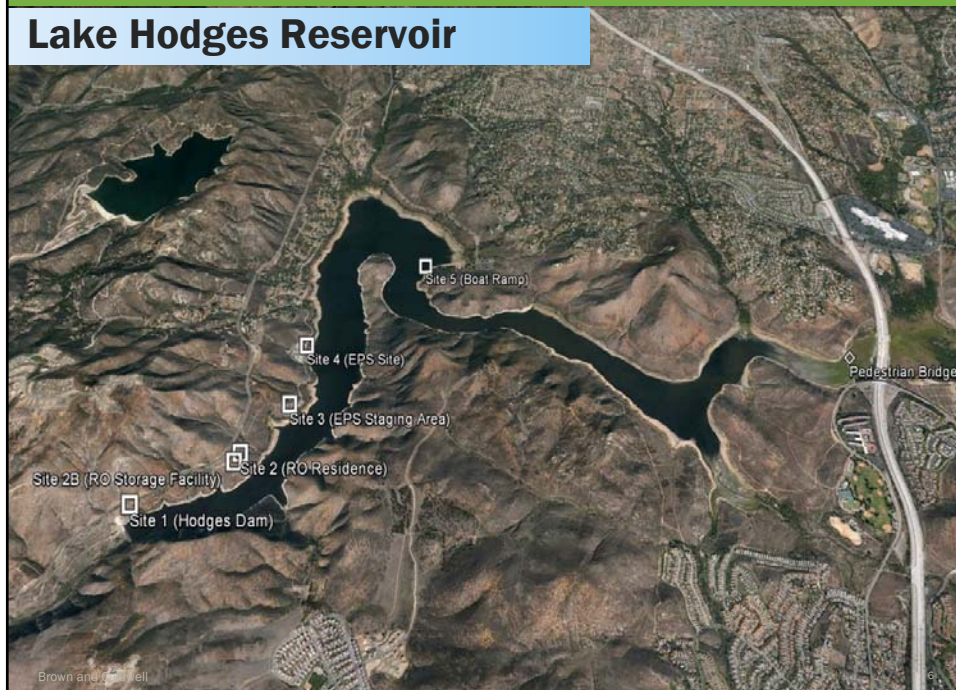

Site 1 – Hodges Dam Area



Site 1 – Hodges Dam

Main spillway area

- Power supply available (3-phase)
- Limited space for Equipment
- Steep terrain and difficult access conditions

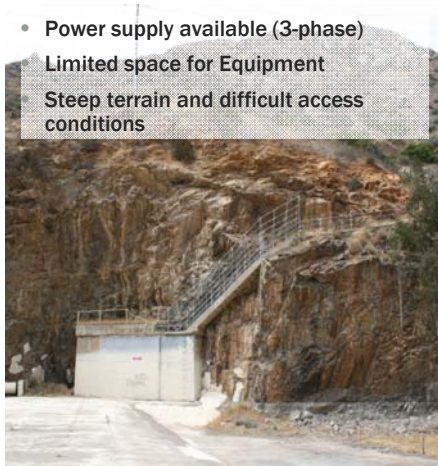

Existing Enclosure



Brown and Caldwell

8

Site 2 – Former Operator’s Residence

Resident Operator Facility



Storage Structure



Brown and Caldwell

9

Site 3 – EPS Construction Staging Area

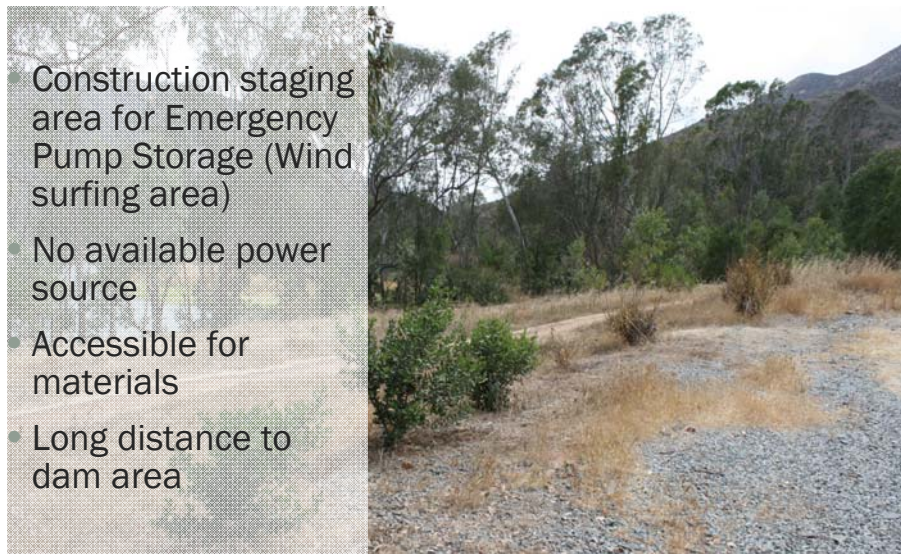

Brown and Caldwell

10

Site 4 - Emergency Pump Storage Facility

- Available Power Supply
- Space for equipment and material delivery
- Long distance to dam



Brown and Caldwell

11

Lake Hodges Bicycle/Pedestrian Bridge Area

- Potential area for siting natural treatment wetlands
- Reduce nutrient contributions to the reservoir
- Potential Approach
Evaluate the City of Escondido's plans for wetland treatment options



Brown and Caldwell



Potential Alternatives for Lake Management

Bill Faisst and Alex Horne



Aerial Location Map



Brown and Caldwell

14

Water Quality, August 2012 Data

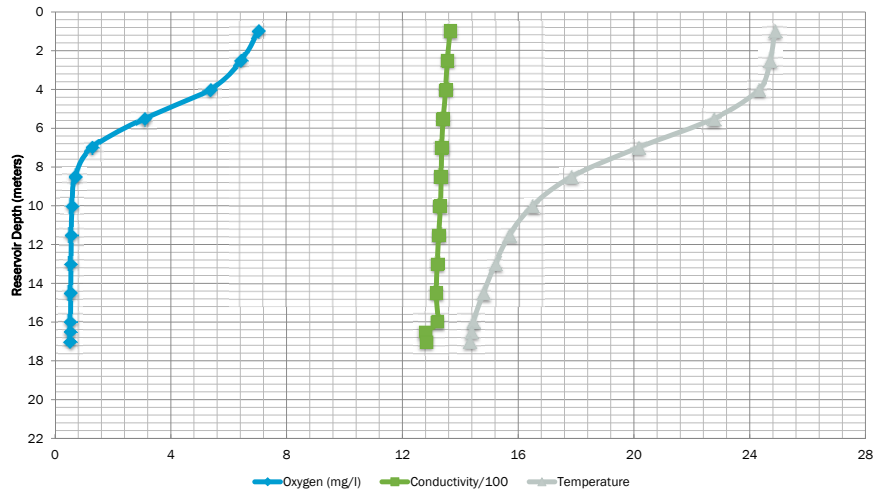

Brown and Caldwell

15

Lake Management Issues

Problem to be addressed	Probable Cause	Other possible causes
Excess algae	High nutrients, warm temperatures, low grazing of algae	Shallow lake areas
Taste & odor (organic)	Planktonic blue-green algae (BGA)	Benthic BGA
Taste & odor (metals)	Eutrophication (low bottom DO)	
Meet WQ objectives	Excess algae	
Control Quagga mussels	Inflows from contaminated sources	

Brown and Caldwell

16

The 17 In-Lake and Lake Bed Methods

Physical controls

- Change lake bathymetry, water/nutrient residence times, sediment chemistry, or light regime. Harvest weeds, algae, trash & fish.

Chemical controls

- Poison the undesirables or restrict anoxia, light or nutrient recycling.

Biological controls

- Eat or harvest the undesirables

Bio-manipulation

- Change the food web and trophic pyramid

Physical Methods

No.	Method	Applicability for Lake Hodges	Use
1	Dredging	Not applicable except in limited areas. High cost limited benefit (?) – may be benefit with new water source	?
2	Water level fluctuation	Occurs already, no edge weed problems	No
3	Mixing &/or destratification	High applicability for VEM in shallower mid-reservoir regions, destratification near dam not advisable (see # 11)	Yes
4	Macrophyte harvesting	None present, weeds not a current problem	No
5	Wetland filters (off-line)	High applicability, locate above upper end of reservoir; can also be used for treatment of summer & some winter urban contaminated runoff. May need Unit Process Wetland design	Yes
6	Algae harvesting	Possible for blue-green algae scums, but only in conjunction with #5 in algae corraling device	Yes
7	Selective withdrawal of hypolimnion	Occurs already via deep drinking water outlets	Yes
8	Dilution/flushing	Will occur with new pump storage but is not factored in eutrophication concepts. Volumes exchanged from deeper water probably not large enough to make large algal reduction	?
9	Sediment sealing (fabrics)	Not applicable, no weed growths round docks or beaches	No

Chemical Methods

No.	Method	Applicability for Lake Hodges	Use
10	Algaecides/herbicides or molluscides	Emergency use only; high cost and regulatory problems downstream after WWTP (aquatic biota sensitive to Cu)	Rare
11	Oxygenation/aeration	Oxygenation in lower stratified reservoir would reduce internal nutrient loading & eliminate much T&O	Yes
12	Shading/dyes	Not applicable; reservoir too large so cost high & benefits only for month or two	No
13	Sediment sealing (chemical, alum etc)	Possible application but large storm water P-loads and exchange with upper P-rich reservoir make cost of regular applications high. Not needed if other methods work	No?

Brown and Caldwell

19

Biological Methods

No.	Method	Applicability for Lake Hodges	Use
14	Pathogens/diseases of algae	Not recommended; method still in research, immunity buildup and cost high for larger reservoirs	No
15	Grazers (on algae or macrophytes)	Not needed, no macrophyte problem. Algae grazing will be enhanced using #11 & # 17	No
16	Nutrient harvesting from fish/weeds	Not recommended as stand alone; only few % annually can be removed but some removal will occur as part of #17	No
17	Bio-manipulation	Recommended: remove carp & excess tiny fish, increase zooplankton (#11) & consider a new design floating or static wetland refuges for zooplankton	Yes

Brown and Caldwell

20

Combined Methods Evaluated for Lake Hodges Reservoir

- A** Hypolimnetic Oxygenation using a Speece Cone in the deeper thermally stratified lower reservoir
- B** VEM (Vigorous Epilimnion Mixing) combined with algae corraling
- C** Biomanipulation
- D** Algaecides/herbicides/molluscicides (& other Quagga treatments)

Brown and Caldwell

21

Assessment of Alternatives

No	Modified Method	Applicability for Lake Hodges
A	Hypolimnetic Oxygenation using a Speece Cone in the deeper thermally stratified lower reservoir	Method maximizes oxygen additions to the sediment-water interface to reduce internal nutrient loading; lower algae & T&O
B	VEM (Vigorous Epilimnion Mixing) combined with algae corraling	Reduces scumming blue-green algae in shallower mid (& upper) reservoir regions, directs scums to collection points for wetlands filtration-removal
C	Wetland filters (off-line) will include Algae corraling prior to harvesting (removal in wetland)	High applicability, locate above upper end of reservoir; can also be used for summer & some winter urban contaminated runoff For blue-green algae scums, can be combined with #5 in algae corraling device
D	Biomanipulation	Recommended to remove carp, increase zooplankton and consider a new design floating wetland refuges
E	Algaecides/herbicides/molluscicides (& other Quagga treatments)	Emergency use only; high cost and regulatory problems downstream after WWTP (aquatic biota sensitive to Cu, PAC20 cost high)

Brown and Caldwell

22

Preliminary Approach

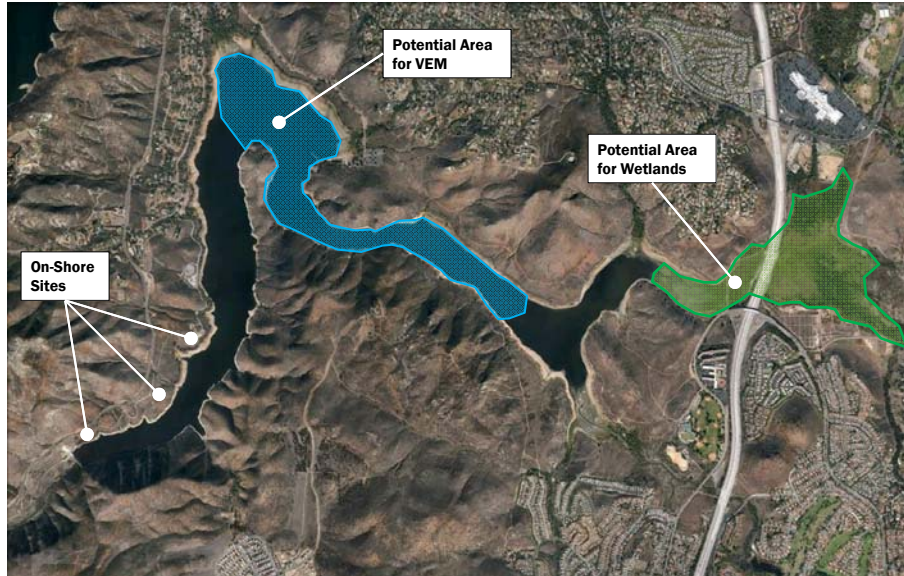

Next Steps

Oliver Galang, PE



Next Steps

Water Quality Model Development (Water Quality Solutions)

- Model Calibration
- Alternative Assessment

Quagga Mussel Assessment , Andrew Cohen

- Evaluation of Quagga Mussel potential

Brown and Caldwell

25

Project Schedule

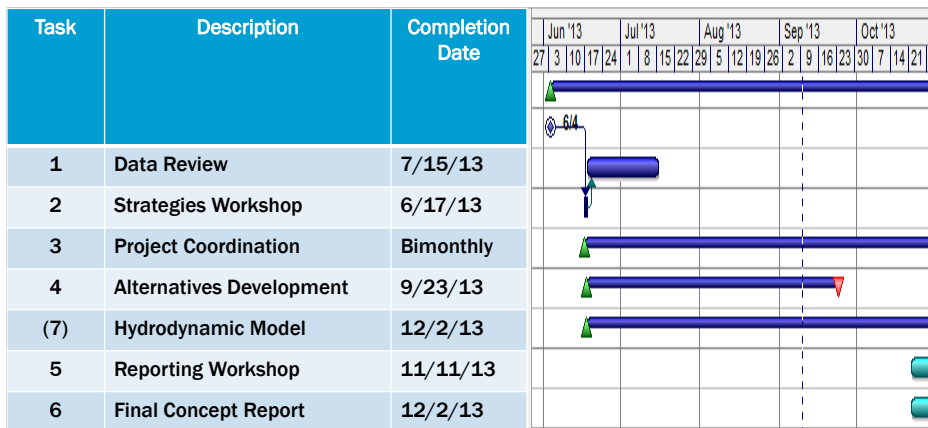



Questions and Comments



Appendix H: Lake Hodges Natural Treatment System Options

Dudek

November 6, 2013

DRAFT MEMORANDUM

To: Trish Boaz, San Dieguito River Valley Conservancy
From: Trey Driscoll, Jonathan Martin and Saurabh Thapar
Subject: Lake Hodges Natural Treatment System Options
Date: November 6, 2013
cc: Helen Davis, Vipul Joshi, Niki McGinnis, Jeff Pasek, Cor Schaffer, Jeff Warner
att: Figure 1

1. Introduction

This memorandum presents a preliminary analysis of nutrient loading to Lake Hodges and discusses two conceptual level options for the natural treatment system (NTS) for Lake Hodges. The two conceptual level options for the NTS include type and location of best management practices (BMPs) that were selected in accordance with the quantity and distribution of nutrient loading (total phosphorus and total nitrogen) to Lake Hodges, as well as the location of public (City) property.

The following sections describe the methodologies adopted for data review, nutrient loading estimation, and selection of two conceptual level options for the NTS.

2. Water Quality and Stream Flow Data Review

Dudek reviewed available water quality data and stream flow measurements recorded by the City of San Diego between 2000 and 2013 to determine seasonal and annual trends in nutrient concentrations (total nitrogen and total phosphorus) and stream flow. Additionally, Dudek reviewed the continuous stream flow data collected at 15 minute intervals by Weston Solutions, Inc. (WESTON). WESTON collected 15 minute interval stream flow data from Green Valley Creek between 2010 and 2013, Kit Carson Creek between 2012 and 2013, and Santa Ysabel Creek upstream of Lake Hodges between 2010 and 2011.

A. Stream Flow Data:

- **Santa Ysabel Creek** – Streamflow data from Santa Ysabel Creek was reviewed for the 2010-2011 water year, a water year with above average rainfall. During the 2010-2011 water year, 12.0 inches of rain fell at the center of the Lake Hodges watershed.

In contrast, the estimated average annual rainfall at the centroid of the Lake Hodges watershed is 9 inches based on the 13-year rainfall record from 2000 to 2012 at the Escondido California Irrigation Management Information System (CIMIS) station #153. The review of the streamflow data indicates that runoff does not occur in Santa Ysabel Creek until rainfall satisfies the soil moisture deficit of the watershed. Thus, during below average rainfall water years, stream flow may not occur in Santa Ysabel Creek upstream of Lake Hodges.

- **Base flow from Urban Watersheds** – Streamflow data from the Green Valley (2010-2013) and Kit Carson (2012-2013) urban watersheds were reviewed for the 2012-2013 water years. The 2012-2013 water year was a below average precipitation year, with the Lake Hodges watershed receiving 5.5 inches of precipitation. The stream gauges in the urban watersheds register perennial base-flow during this below average water year.

The stream gauge data were used to estimate nutrient loading from Green Valley, Kit Carson and Santa Ysabel Creeks. The nutrient loading was estimated for the water years 2010-2011 (above average rainfall) and 2012-2013 (below average rainfall) using the following formula.

$$\text{Nutrient Loading} = \text{Volume of Discharge} * \text{Nutrient Concentration}$$

Where:

Volume of Discharge was recorded by WESTON, and

Nutrient Concentration was recorded by the City of San Diego

Although nutrient loading was calculated for both nitrogen and phosphorous, this memo focuses on the results of the phosphorous loading calculations because it is the primary nutrient of concern in Lake Hodges.

3. Nutrient Loading 2010-2011 Water Year: Above Average Rainfall

The nutrient loading to Lake Hodges for the 2010-2011 water year was estimated separately for Santa Ysabel Creek and the urban watersheds comprising Green Valley, Kit Carson, and Felicita Creeks (Table 1). Gaps in WESTON's runoff data were corrected assuming a linear relationship between stream flow measurements taken upstream of the WESTON gauges by the City of San Diego.

Nutrient Loading from Santa Ysabel Creek during the 2010-2011 Water Year

- Approximately 18,300 pounds (lbs) of total phosphorus entered Lake Hodges from Santa Ysabel Creek during the 2010-2011 water year (Table 1).

Nutrient Loading from Urban Watersheds during the 2010-2011 Water Year

- Approximately 1,180 lbs of total phosphorus entered Lake Hodges from Green Valley Creek during the 2010-2011 water year. The stream flow record from Kit Carson Creek only covers the time period 10/8/2012 through 2/27/2013, during a below average water year. During this time period, Kit Carson Creek contributed approximately 175 pounds of total phosphorous to Lake Hodges, which is similar to the approximately 220 pounds of total phosphorous contributed by Green Valley Creek over the same time period. Based on the similar contributions during the 2012-2013 water year, Kit Carson Creek is assumed to have contributed a similar total phosphorous load to Lake Hodges as Green Valley Creek during the 2010-2011 water year.
- There are no continuous stream flow measurements from the Felecita Creek watershed. Therefore, a total phosphorous loading cannot be calculated for this watershed. However, for the purposes of this analysis, the total phosphorous loading from Felecita Creek was assumed to equal that of the Kit Carson, or Green Valley Creeks. The Felecita Creek watershed shares many characteristics with the Kit Carson and Green Valley watersheds, although it is smaller than either of the other urban watersheds in the study. Therefore, by assuming that the total phosphorous load contributed by Felecita Creek equals that of Kit Carson and Green Valley Creeks, we have assumed a conservative loading potential for this creek.
- Under the assumptions discussed above, the three urban watersheds draining directly to Lake Hodges collectively contributed approximately 3,500 pounds of total phosphorus during the 2010-2011 water year (Table 1). The total phosphorous load is approximately 5 times higher in Santa Ysabel Creek than in the other three urban watersheds combined, indicating that the undeveloped portion of the watershed contributes a majority of the total phosphorus load to Lake Hodges.

Table 1. Nutrient Loading during 2010-2011 Water Year

Tributary	Total Discharge (acre-feet)	Nutrient Loading	
		Nitrogen (lb/wet year)	Phosphorus (lb/wet year)
Santa Ysabel Creek	20,060	60,210	18,330
Urban Watersheds (Green Valley, Kit Carson, and Felicita)	7,100	16,390	3,530

4. Nutrient Loading 2012-2013 Water Year: Below Average Rainfall

Nutrient loading was calculated during the 2012-2013 water year, which only received approximately 60% of the average annual rainfall (compared to a 13-year average of 9.0 inches).

Nutrient Loading from Santa Ysabel Creek during the 2012-2013 Water Year

- As the soil moisture deficit of the watershed was not satisfied, there was no observed discharge in Santa Ysabel Creek during the 2012-2013 water year. Therefore, no nutrient loading from surface flow was estimated from Santa Ysabel Creek during this year (Table 2).

Nutrient Loading from Urban Watersheds during the 2012-2013 Water Year

- Approximately 600 lbs of total phosphorus entered Lake Hodges from Green Valley, Kit Carson, and Felicita urban watersheds between October 2012 and March 2013. Extrapolating this nutrient loading rate would result in an annual total phosphorous loading of approximately 1,620 lbs during the 2012-2013 water year (Table 2).

Table 2. Nutrient Loading during 2012-2013 Water Year

Tributary	Total Discharge (acre-feet)	Nutrient Loading	
		Nitrogen (lb/dry year)	Phosphorus (lb/dry year)
Santa Ysabel Creek ¹	0	0	0
Urban Watersheds (Green Valley, Kit Carson, and Felicita)	3,260	7,520	1,620

1. 'Zero-discharge' is assumed based on observations made by the City of San Diego; WESTON's gage was not in operation during this period.

5. Natural Treatment System Options

The majority of the nutrient loading into Lake Hodges occurred during the above average water year (2010-2011) from Santa Ysabel Creek. During this water year, Santa Ysabel Creek is estimated to have contributed approximately 18,330 pounds of total phosphorous to Lake Hodges, and the urban watersheds are estimated to have contributed approximately 3,530 pounds of total phosphorous.

During the 2012-2013 water year, the total phosphorous loading to Lake Hodges is approximately 13 times smaller than the loading during the 2010-2011 water year. Base flow in the urban watersheds was the predominant source of nutrient loading during the 2012-2013 water year, as discharge was not observed from Santa Ysabel Creek during this year.

Based on the aforementioned observations, the following two conceptual level options for the NTS are recommended. These NTS options include type and location of BMPs that were selected in accordance with the quantity and distribution of nutrient loading to Lake Hodges. Figure 1 depicts the areas available to the two NTS options based on the boundaries of publicly owned (City) land.

- **Option 1 - NTS-A** – The first option for NTS consists of a large wetland located upstream of Lake Hodges and a series of detention basins located along the main stem of Santa Ysabel Creek. The large wetland located upstream of Lake Hodges would be designed to capture and treat discharge from Santa Ysabel Creek before it enters Lake Hodges and would be sustained year round by water pumped from Lake Hodges. Farther upstream, the series of detention basins would be located in the agricultural fields near the confluence of Santa Maria Creek and Santa Ysabel Creek. These detention basins would be designed to capture and treat discharge and would also result in a reduction of the peak flow in Santa Ysabel Creek. Sizing of the wetland and detention basin will depend on the water quality volume (WQV) selected for this option.
- **Option 2 - NTS-B** – The second option for NTS consists of a series of smaller wetlands and detention basins located at the confluences of the three tributaries draining the urban watersheds directly into Lake Hodges. These include the urban watersheds of Kit Carson, Green Valley, and Felicita. This NTS option would be designed to capture and treat the urban base flow and smaller storm events discharging from the Kit Carson, Green Valley, and Felicita urban watersheds. Two other locations for detention basins have been highlighted for this option in Figure 1: a) At the confluences of Cloverdale Creek and Santa Ysabel Creek, and b) At the confluence of Santa Maria Creek with Santa Ysabel

Memorandum

Subject: Lake Hodges Natural Treatment System Options

Creek. With the additions of these detention basins, this NTS option could help reduce nutrient loading during small rainfall/runoff events.

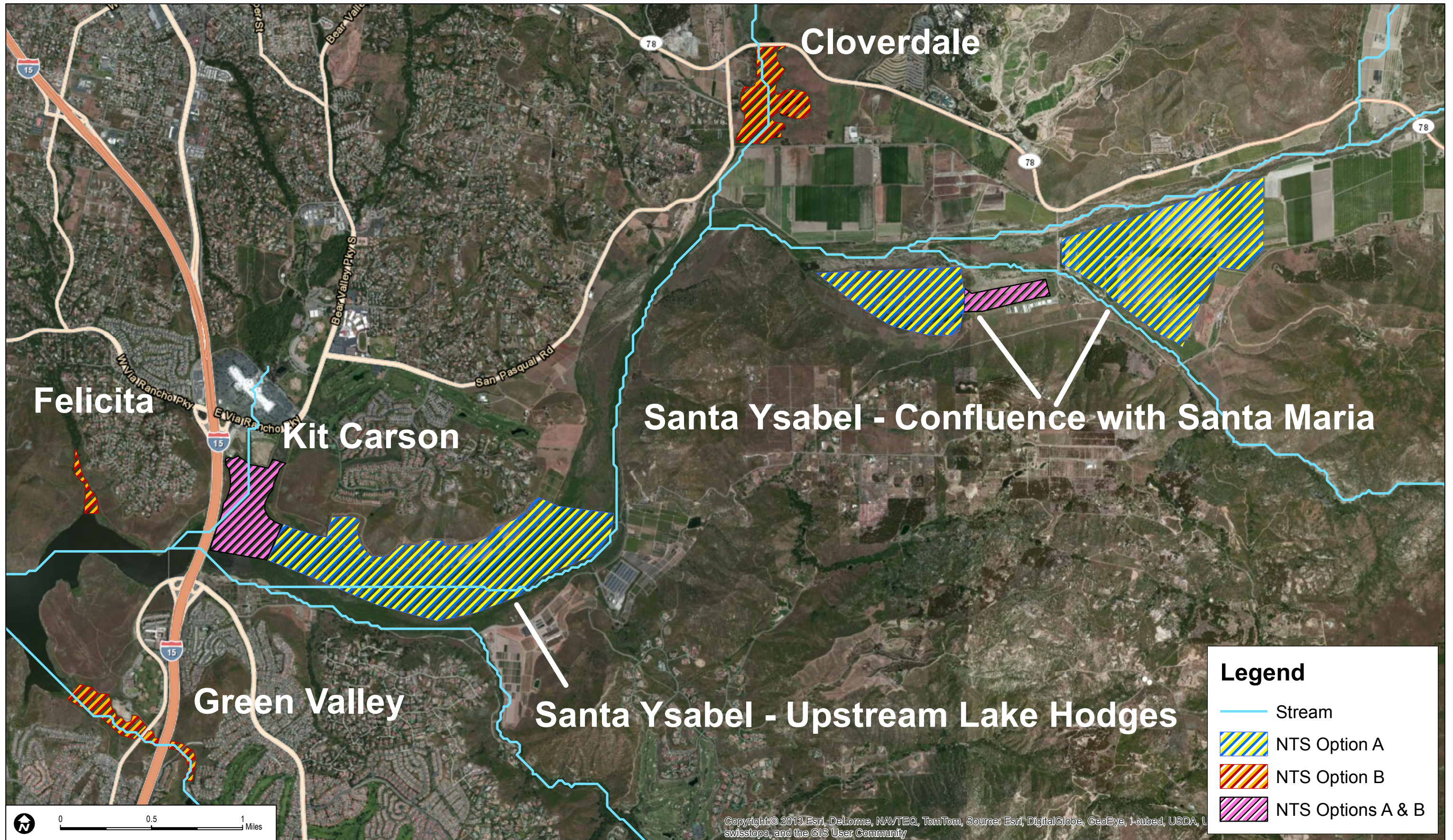

Appendix I: Evaluation of Lake for Phycocyanin, Technical Report

Blue Water Satellite

October 2, 2013

Blue Water Satellite Technical Report

Client	Brown and Caldwell
Client Contact	William Faisst
Project Location	Lake Hodges, South of Escondido, San Diego County, California
Project Scope	Evaluation of Lake for Phycocyanin
Satellite Overpass Dates	7-30-2012, 8-31-2012, 7-17-2013, 8-18-2013
Report Date	October 2, 2013
Details of Project	Blue Water Satellite provided scans of Lake Hodges, South of Escondido, San Diego County, California, for Phycocyanin for four dates in 2012 and 2013.
BWS Project Facilitator	Linda Orłowski
BWS Image Processor	Allan Adams
Reporting Period	October 2013



440 E. Poe Road Suite 201
Bowling Green, OH 43402
(419) 728-0060
www.BlueWaterSatellite.com

History of Project

Blue Water Satellite, Inc. received an order through Brown and Caldwell to produce sets of one scan/dataset per month for July and August of 2012 and 2013 for evaluation of Phycocyanin in Lake Hodges, South of Escondido, San Diego County, California.

Scope of Project

1. Natural Color Satellite scan for Lake Hodges, California. Client requested that data be produced for one date during the month of July 2012.
2. Satellite scan and analysis for Phycocyanin in Lake Hodges, California. Client requested that data be produced for one date during the month of July 2012.
3. Natural Color Satellite scan for Lake Hodges, California. Client requested that data be produced for one date during the month of August 2012.
4. Satellite scan and analysis for Phycocyanin in Lake Hodges, California. Client requested that data be produced for one date during the month of August 2012.
5. Natural Color Satellite scan for Lake Hodges, California. Client requested that data be produced for one date during the month of July 2013.
6. Satellite scan and analysis for Phycocyanin in Lake Hodges, California. Client requested that data be produced for one date during the month of July 2013.
7. Natural Color Satellite scan for Lake Hodges, California. Client requested that data be produced for one date during the month of August 2013.
8. Satellite scan and analysis for Phycocyanin in Lake Hodges, California. Client requested that data be produced for one date during the month of August 2013.

Methodology

Blue Water Satellite, Inc. (BWSI) acquires raw data from satellites Landsat 7 and Landsat 8, operated by the United States Geological Survey (USGS). The raw data is processed using BWSI's patented and proprietary algorithms. BWSI detects the locations and concentrations of Cyanobacteria, Total Phosphorous, Surface Water Temperature, and Chlorophyll-a in rivers, lakes, reservoirs, streams, ponds, and other bodies of water around the world. For the detection and measurement of Cyanobacteria, BWSI detects and measures Phycocyanin, the pigment unique to Cyanobacteria. Our patented and proprietary technology allows us to measure these constituents in parts per billion (PPB). Each individual sample measures 30-meter by 30-meter pixel resolution.

All data is delivered via an ftp website link located at www.bluewatersatellite.com. Please contact your project facilitator for your login information. Data is delivered in .TIF, .JPEG and .txt formats.

As of April 1, 2013, the USGS has initiated new corrections to Landsat 7 TM imagery. The corrections are being analyzed by BWSI scientists to ensure the integrity of BWSI proprietary algorithms. If corrections made by the USGS have caused deviations in BWSI algorithms, the client will be notified and the subsequent imagery will be reprocessed and delivered to the client at no cost.

Project Outputs

Natural Color Image¹, July 30, 2012 – Landsat 7
Lake Hodges, CA

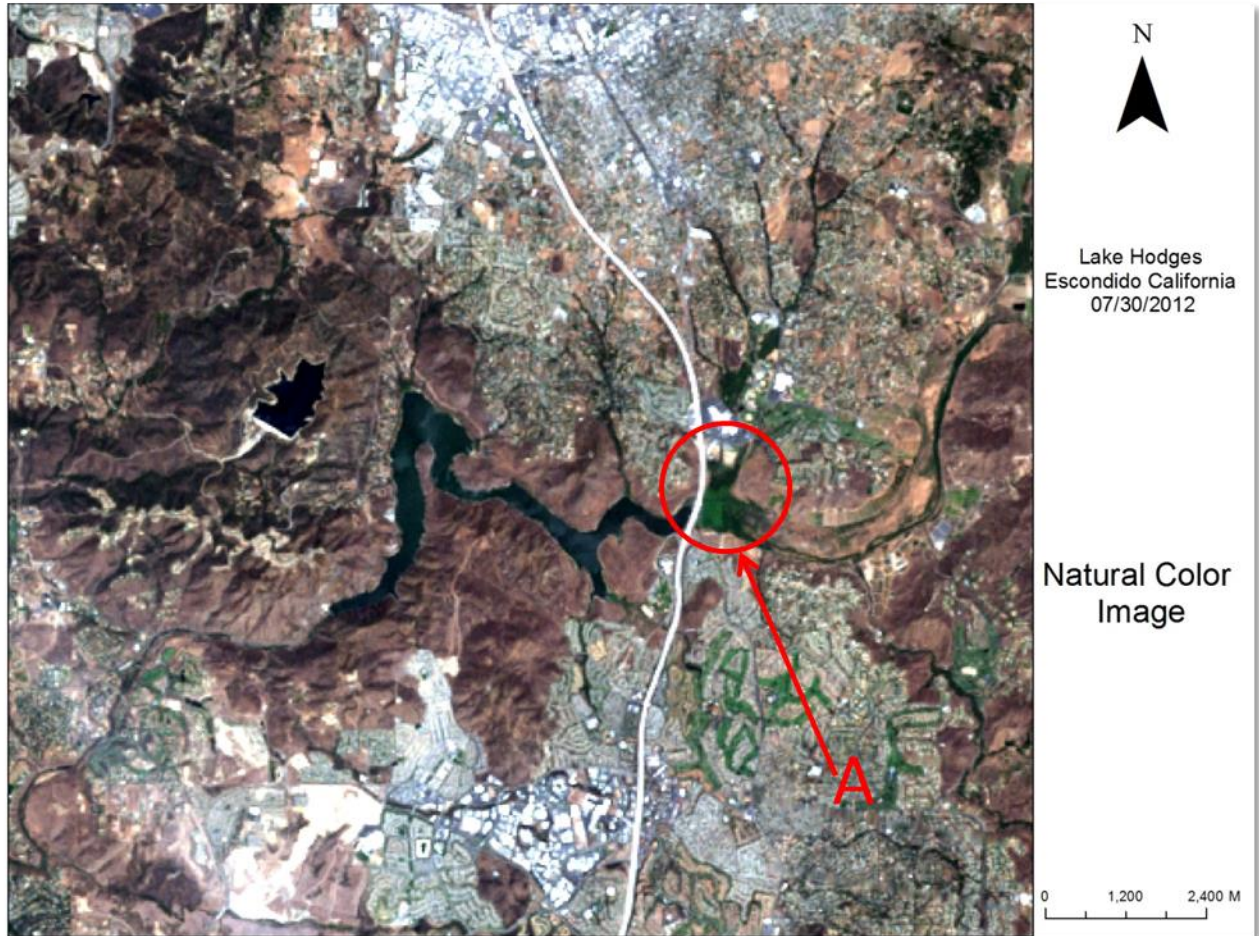

A: Area of interest; the red area represents the predetermined area of interest. It was determined that the area of interest contained shallow water (less than 2 meters in depth) or a high density of vegetation. Both situations hinder the ability of BWSI algorithms to detect any water constituents within the area of interest.

**Phycocyanin, July 30, 2012 – Landsat 7
Lake Hodges, CA**

Overlay on natural color base map of surrounding landscape²

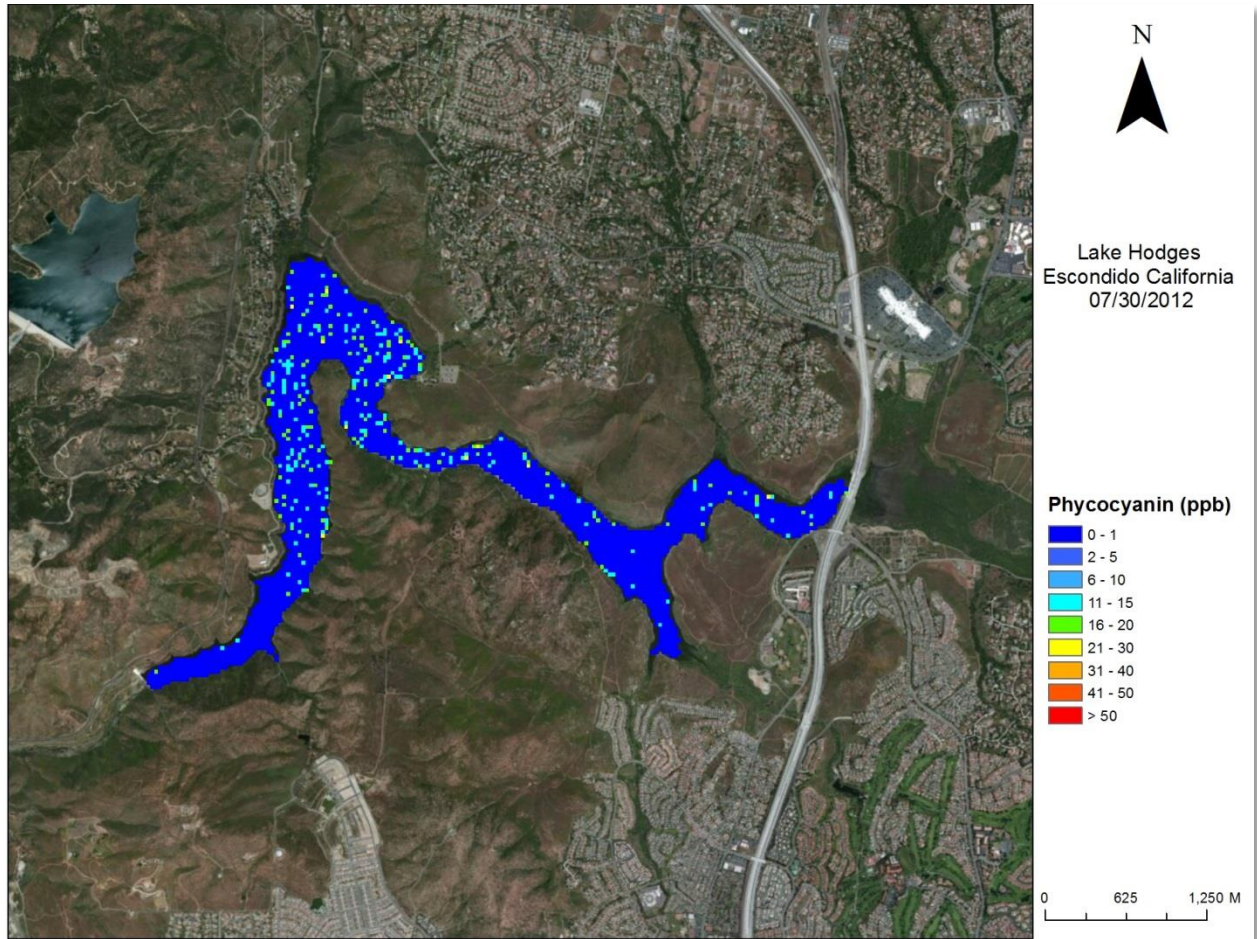

PC (PPB)	Area (Acres)	Percent of Lake
0 - 1	631.82	90.74
2 - 5	0.00	0.00
6 - 10	0.00	0.00
11 - 15	38.70	5.56
16 - 20	24.46	3.51
21 - 30	1.33	0.19
31 - 40	0.00	0.00
41 - 50	0.00	0.00
>50	0.00	0.00

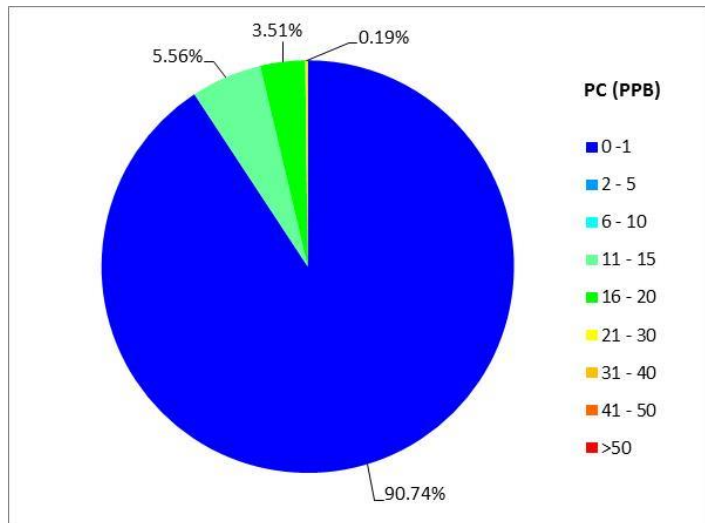
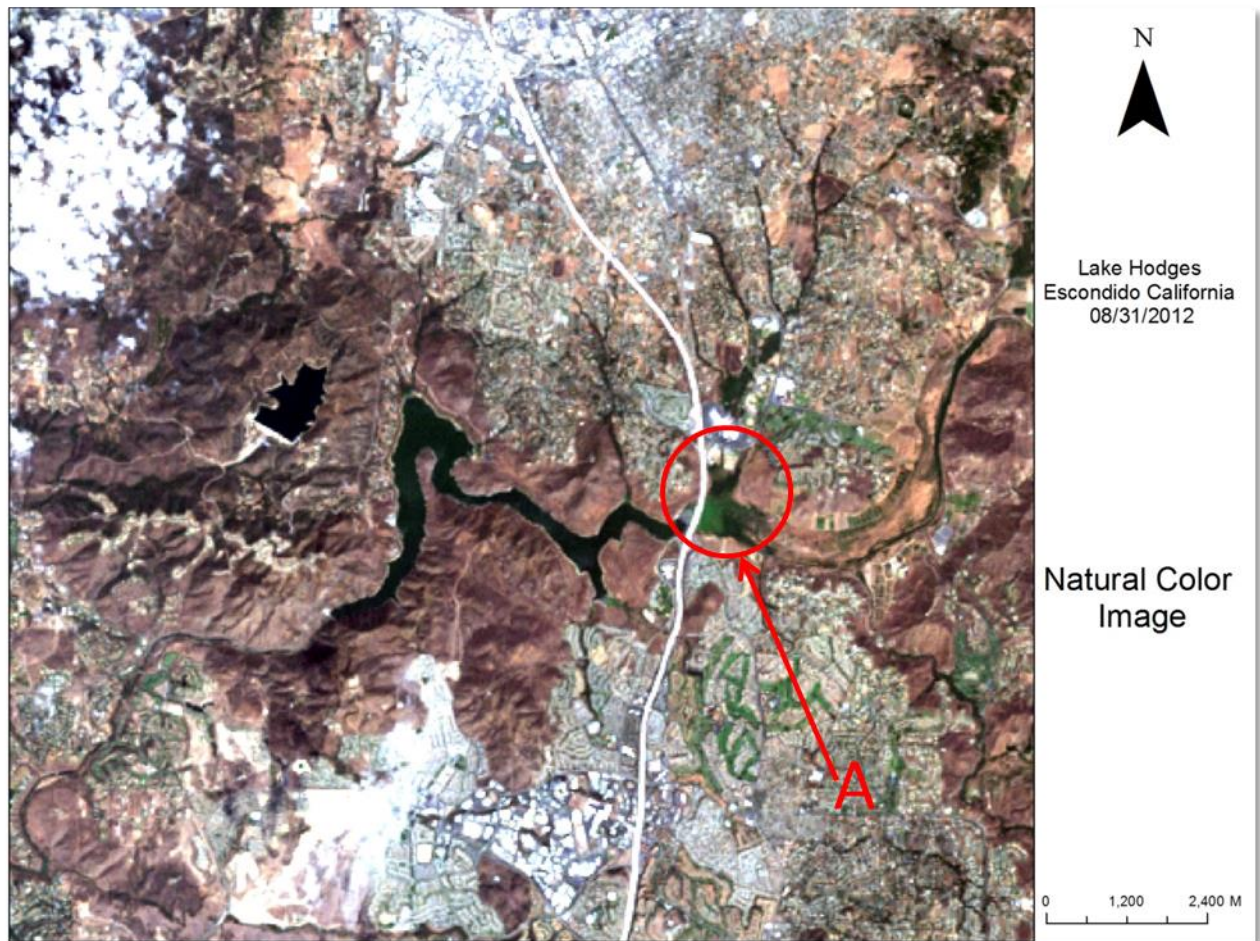

Table 1: Area and Percent of PC ranges

Pie chart histogram indicates the percentage within the view, and is delineated by ranges.

**Natural Color Image¹, August 31, 2012 – Landsat 7
Lake Hodges, CA**



A: Area of interest; the red area represents the predetermined area of interest. It was determined that the area of interest contained shallow water (less than 2 meters in depth) or a high density of vegetation. Both situations hinder the ability of BWSI algorithms to detect any water constituents within the area of interest.

**Phycocyanin, August 31, 2012 – Landsat 7
Lake Hodges, CA**

Overlay on natural color base map of surrounding landscape²

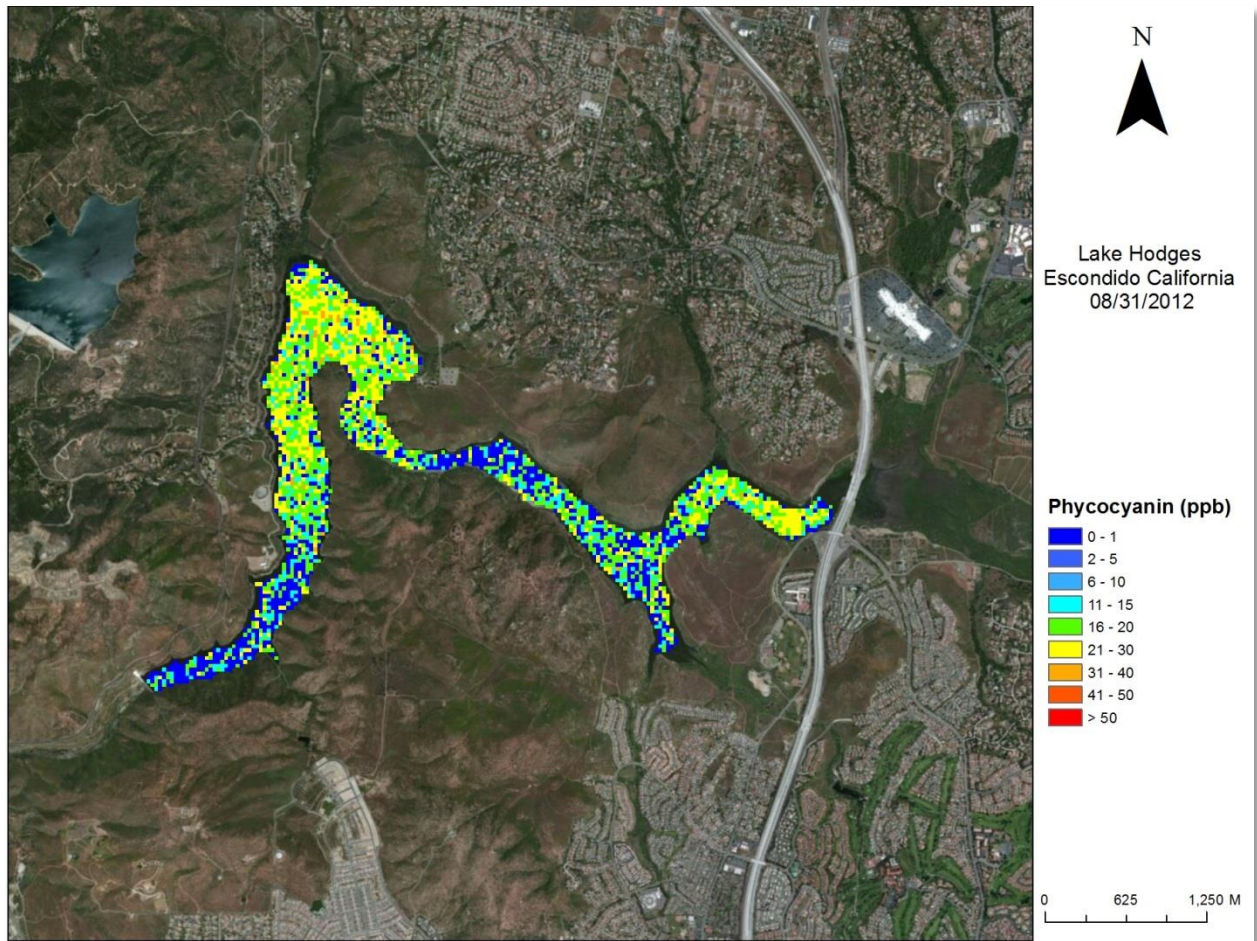

PC (PPB)	Area (Acres)	Percent of Lake
0 - 1	178.81	27.49
2 - 5	0.00	0.00
6 - 10	0.00	0.00
11 - 15	82.73	12.72
16 - 20	201.04	30.91
21 - 30	178.36	27.42
31 - 40	9.34	1.44
41 - 50	0.22	0.03
>50	0.00	0.00

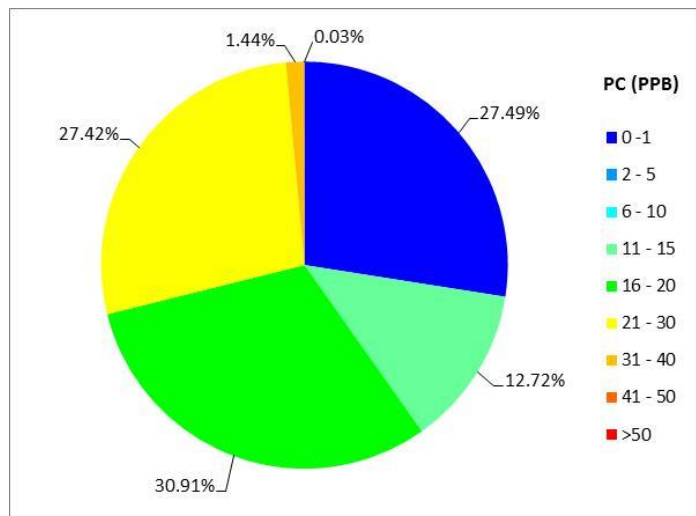
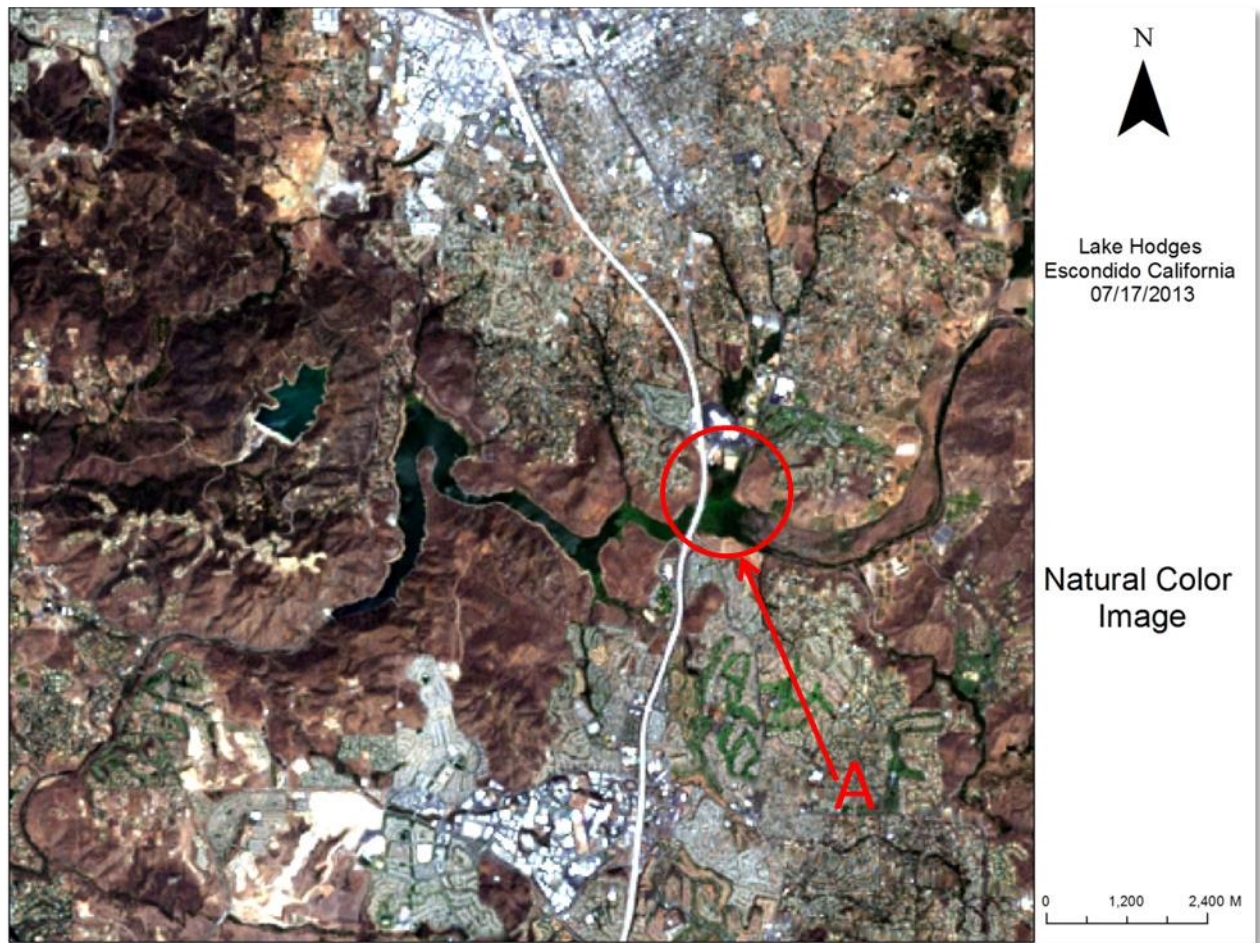

Table 2: Area and Percent of PC ranges

Pie chart histogram indicates the percentage within the view, and is delineated by ranges.

**Natural Color Image¹, July 17, 2013 – Landsat 7
Lake Hodges, CA**



A: Area of interest; the red area represents the predetermined area of interest. It was determined that the area of interest contained shallow water (less than 2 meters in depth) or a high density of vegetation. Both situations hinder the ability of BWSI algorithms to detect any water constituents within the area of interest.

**Phycocyanin, July 17, 2013 – Landsat 7
Lake Hodges, CA**

Overlay on natural color base map of surrounding landscape ²

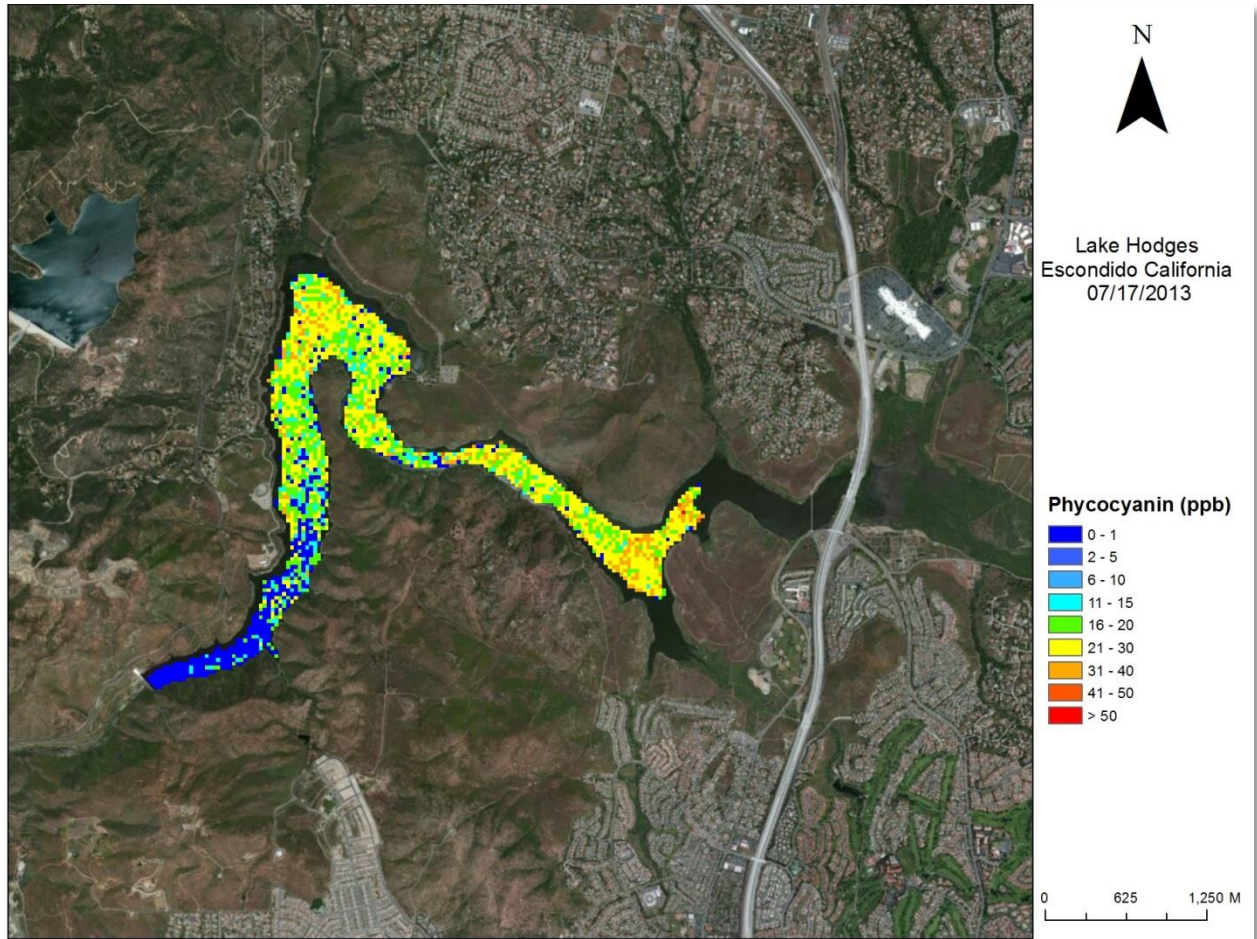

PC (PPB)	Area (Acres)	Percent of Lake
0 - 1	89.85	17.68
2 - 5	0.00	0.00
6 - 10	0.00	0.00
11 - 15	39.59	7.79
16 - 20	131.88	25.95
21 - 30	205.72	40.48
31 - 40	39.59	7.79
41 - 50	1.33	0.26
>50	0.22	0.04

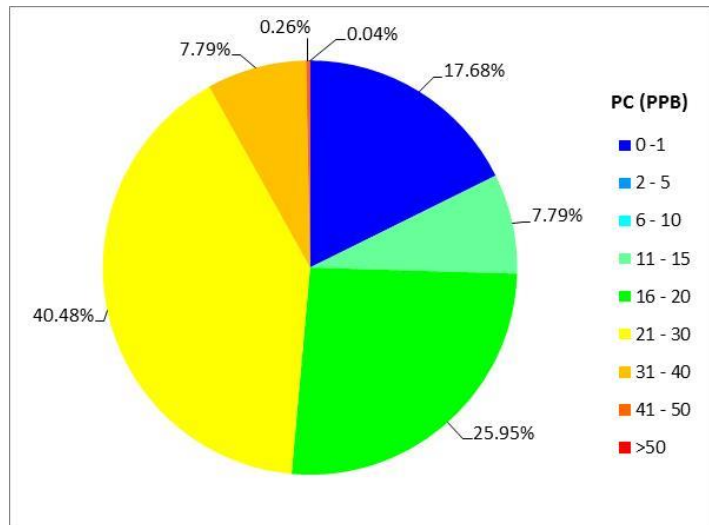
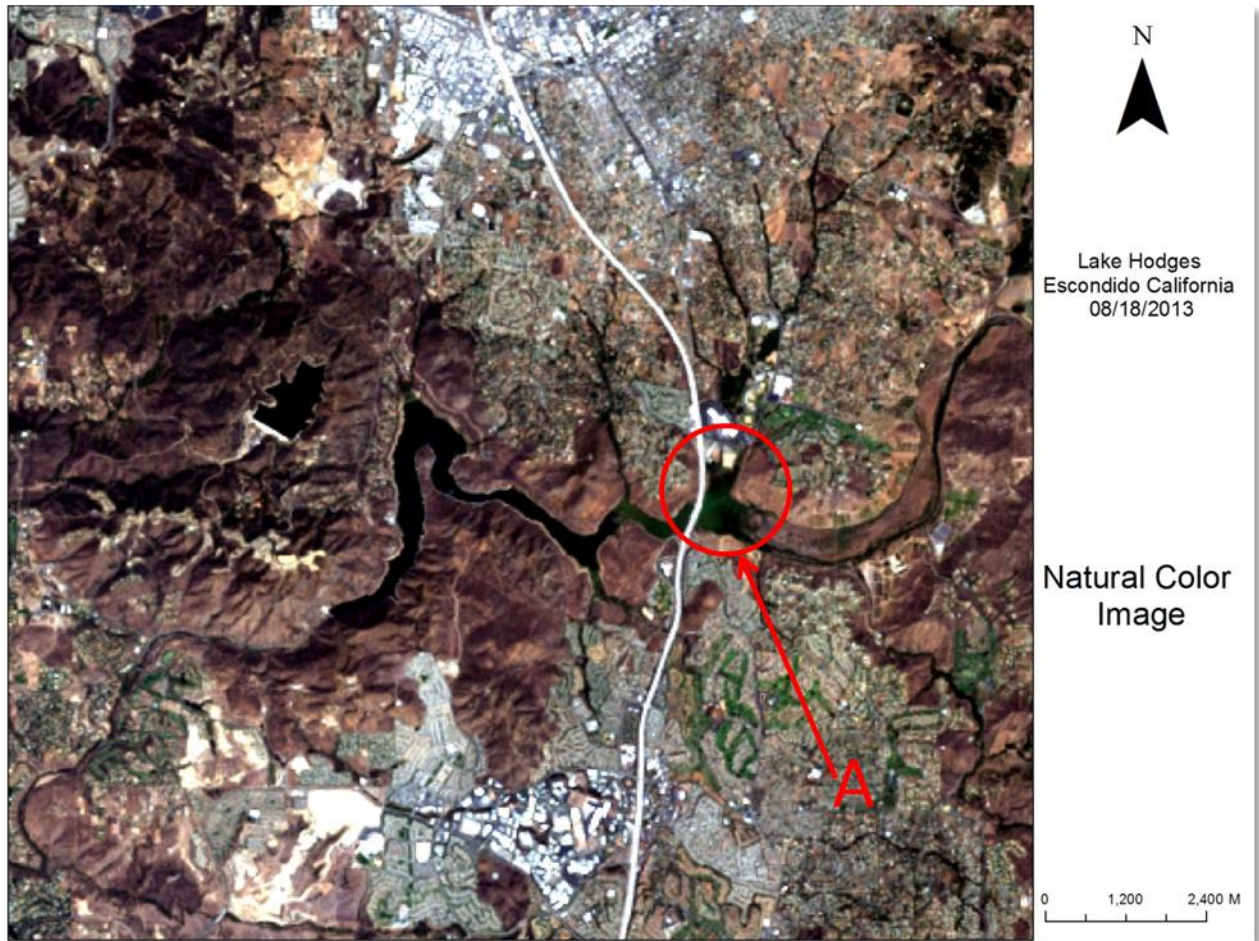

Table 3: Area and Percent of PC ranges

Pie chart histogram indicates the percentage within the view, and is delineated by ranges.

**Natural Color Image¹, August 18, 2013 – Landsat 7
Lake Hodges, CA**



A: Area of interest; the red area represents the predetermined area of interest. It was determined that the area of interest contained shallow water (less than 2 meters in depth) or a high density of vegetation. Both situations hinder the ability of BWSI algorithms to detect any water constituents within the area of interest.

**Phycocyanin, August 18, 2013 – Landsat 7
Lake Hodges, CA**

Overlay on natural color base map of surrounding landscape ²

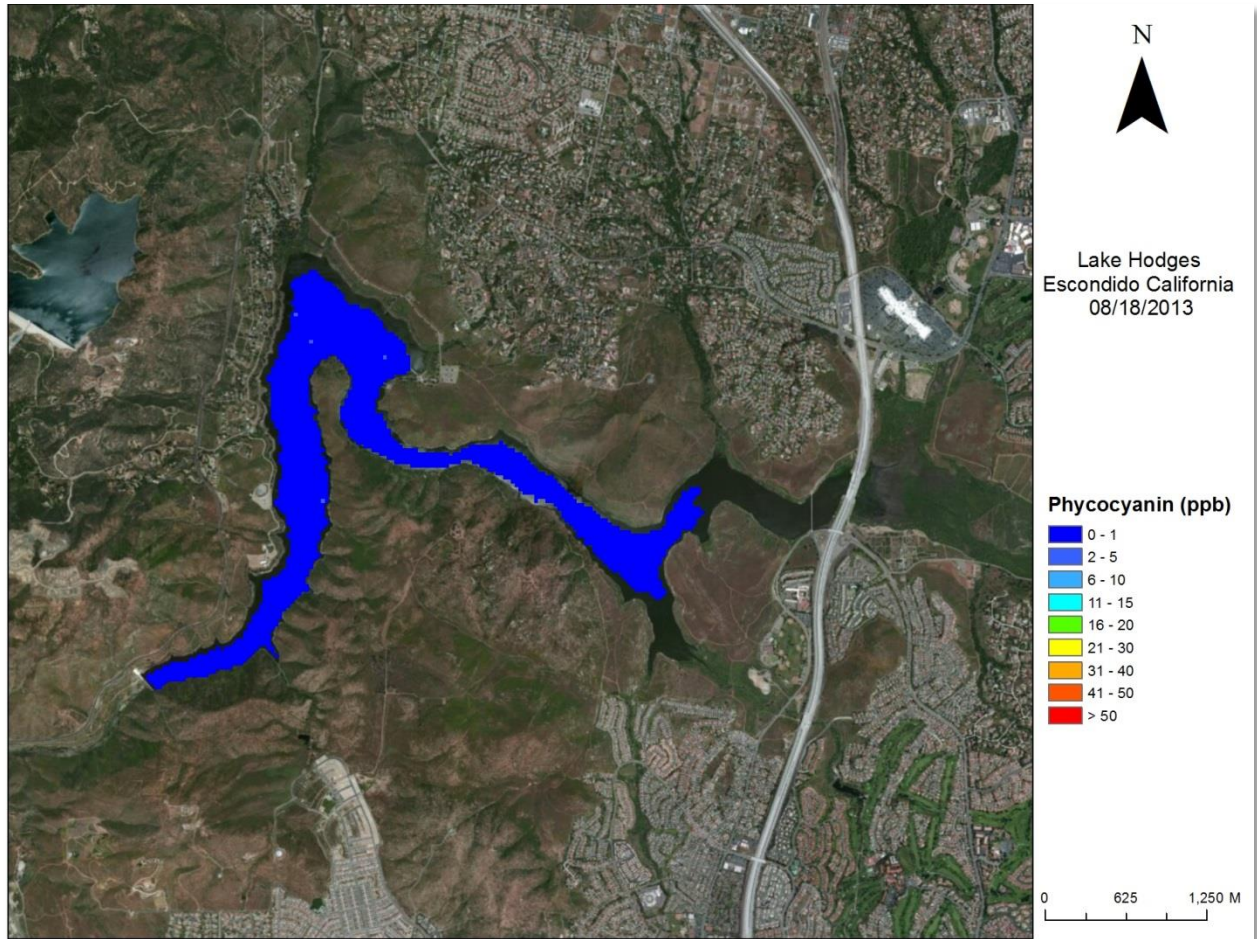

PC (PPB)	Area (Acres)	Percent of Lake
0 - 1	504.39	100.00
2 - 5	0.00	0.00
6 - 10	0.00	0.00
11 - 15	0.00	0.00
16 - 20	0.00	0.00
21 - 30	0.00	0.00
31 - 40	0.00	0.00
41 - 50	0.00	0.00
>50	0.00	0.00

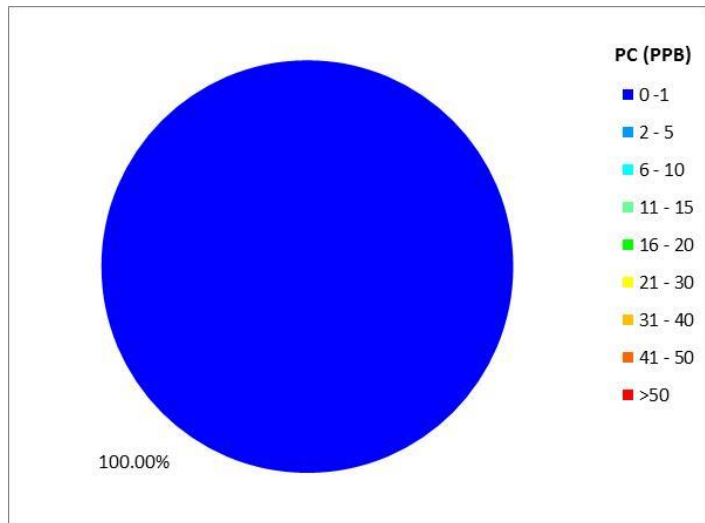

Table 4: Area and Percent of PC ranges

Pie chart histogram indicates the percentage within the view, and is delineated by ranges.

Notes

1. Natural color images are made from the blue, green, and red bands of Landsat 7. For stretch values, see .txt file provided with other data.
2. Natural color base maps are high resolution stock imagery from ESRI, with a different acquisition than the processed imagery.

Conclusions

The following conclusions about Phycocyanin can be made about imagery processed for the observed dates in Lake Hodges, California:

1. July 30, 2012: Phycocyanin concentration values ranged from 11 to 30 ppb across more than 9% of the lake, with more than 90% of the lake containing values of 0-1 ppb.
2. August 31, 2012: Phycocyanin concentration values ranged from 11 to 30 ppb across 71% of the lake, with more than 27% of the lake containing values of 0-1 ppb, and more than 1% of the lake containing concentrations above 31 ppb.
3. July 17, 2013: Phycocyanin concentration values ranged from 11 to 30 ppb across more than 74% of the lake, with more than 18% of the lake containing values of 0-1 ppb, and more than 8% of the lake containing concentrations above 31 ppb.
4. August 18, 2013: 100% of the lake contained Phycocyanin concentration values of 0-1 ppb.

Lake Hodges displayed a cyanobacteria bloom on August 31, 2012, and July 17, 2013, and did not display a bloom on July 30, 2012, and August 18, 2013. Lake Hodges from July 30, 2012, to August 18, 2013, experienced a 27.5% loss in total surface water (approximately 192 acres).

Further Analysis Available from Blue Water Satellite

After Brown and Caldwell has reviewed this report, questions may arise regarding data trends. Blue Water Satellite, Inc. has a variety of tools which would allow data trend comparisons such as:

- Plotting single month data variability over the years analyzed
- Plotting seasonal variations over the years analyzed
- Compare constituent variability in a chronologic sequence (for example, compare each constituent month by month or year to year).

Use of BWSI TIF files in Your GIS Software

As a client of Blue Water Satellite, Inc., you are also being provided with GeoTIF files for each individual constituent scanned, a natural color image of the surrounding landscape, a text file with the color values for the natural color background image, and an instruction manual for using Blue Water Satellite, Inc. GeoTIF files in your ArcGIS or QGIS program. Once properly uploaded in your GIS program, the GeoTIF files will enable you to:

- Isolate small areas for closer inspection
- Identify specific concentrations of each constituent in each 30m x 30m sample area in addition to the ranges given in this report
- Overlay the scan on other digital maps or charts

Questions or Need Help?

Linda Orłowski
Vice President of Sales
Blue Water Satellite
440 E Poe Rd Suite 201
Bowling Green, OH 43402
(419)-728-0060 ext. 106
(419)-746-4306 direct office and mobile